

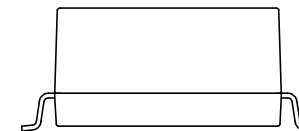

NOTES:

1. ROHS COMPLIANT
2. HEADER: DAP (DIALLYL PHTHALATE) WITH FLAMMABILITY RATING UL 94V-0 OR BETTER.
3. STORAGE TEMPERATURE: -50°C TO +125°C
4. COMPLIANCE TO J-STD:
 - A. J-STD-002: SOLDERABILITY AT 245°C REFLOW PROFILE
 - B. J-STD-020: LEVEL 1, NO MOISTURE SENSITIVE
 - C. J-STD-075: R7, 245°C MAXIMUM THROUGH REFLOW SOLDER
5. TO ORDER TAPE & REEL PACKAGING ADD A "T" SUFFIX TO THE PART NUMBER(i.e HDX8006NL BECOMES HDX8006NLT).

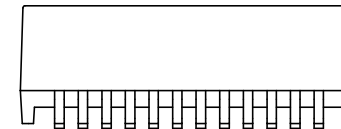
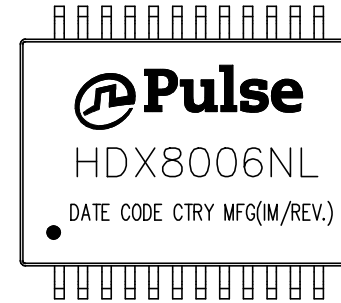

FINAL OUTLINE

© Copyright, 2018. Pulse Electronics Corp. All rights reserved. Pulse confidential & proprietary. (06/29/18)

PRODUCT DESCRIPTION	TLA DRAWING	PS DRAWING	SHEET	PART NO.	DATASHEET REV.
MDL,SIN,HDBT,1:1,POEPP,SM,TU	HDX8006NL-P4	PS-2473.001-C	1 OF 3	HDX8006NL	C

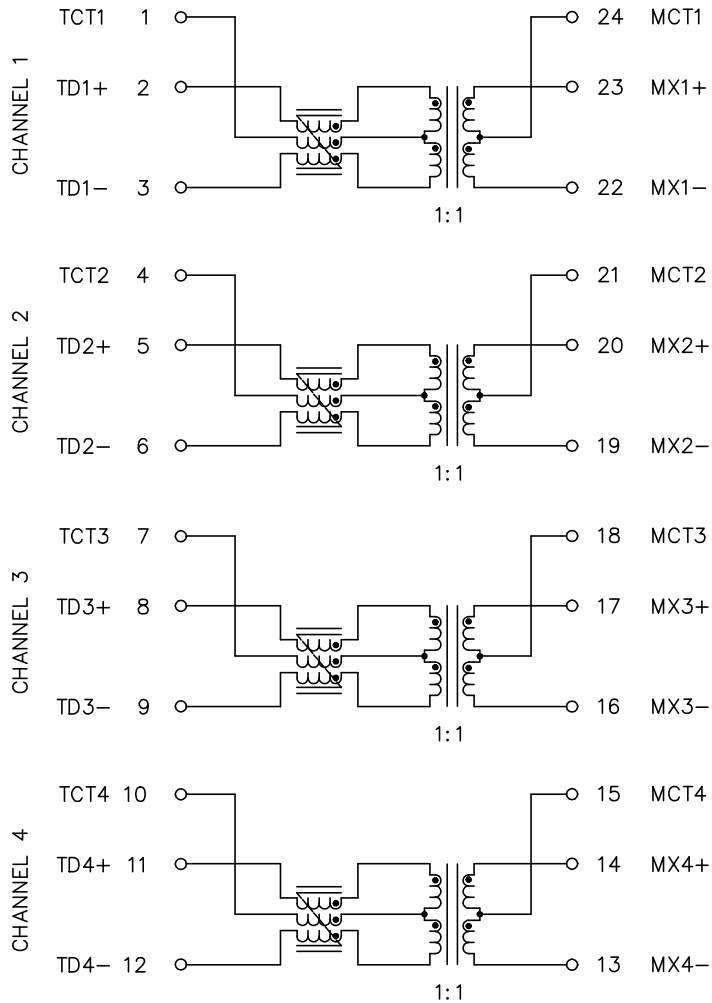

SCHEMATIC

ELECTRICAL CHARACTERISTICS AT +25°C UNLESS OTHER SPECIFIED

MEETS IEEE 802.3 SPECIFICATION

PARAMETER	SPECIFICATIONS				
OPERATING TEMPERATURE	-40°C TO +85°C				
TURNS RATIO	1.00 ± 2%				
POLARITY	PER SCHEMATIC				
INSERTION LOSS (SDD21)	100 KHz	1-200 MHz	300 MHz	400 MHz	500 MHz
	-3.0 dB MAX	-1.0 dB MAX	-1.8 dB MAX	-2.0 dB MAX	-3.0 dB MAX
PHY-SIDE RETURN LOSS (SDD11 - Zref = 100 OHMS ± 1%)	1-100 MHz		100-500 MHz		
	-20 dB MIN		-20+18.3*LOG ₁₀ (f/100 MHz) dB MIN		
INDUCTANCE (OCL) (MEDIA SIDE, -40°C TO +85°C)	120 uH MIN (MEASURED AT 100 KHz, 100 mVRMS AND WITH 25 mA DC BIAS)				
CROSSTALK, ADJACENT CHANNELS (SDD21 - ADJ.)	1-100 MHz		100-500 MHz		
	-33 dB MIN		-22 dB MIN		
COMMON MODE REJECTION RATIO (SCC21)	1 MHz-100 MHz		100-300 MHz	300-500 MHz	
	-37 dB MIN		-30 dB MIN	-25 dB MIN	
COMM. TO DIFF. REJECTION RATIO (SDC12)	1 MHz-100 MHz		100-300 MHz	300-500 MHz	
	-40 dB MIN		-30 dB MIN	-25 dB MIN	
DC RESISTANCE, 1/2 WINDING	.65 OHMS MAX				
DC CURRENT/VOLTAGE RATING	1500 mA MAX @ 57 V (CONTINUOUS)				
INPUT - OUTPUT ISOLATION	1500 VRMS MIN @ 60 SECONDS				

NOTE: f IS FREQUENCY IN MHZ.

© Copyright, 2018. Pulse Electronics Corp. All rights reserved. Pulse confidential & proprietary. (06/29/18)

PRODUCT DESCRIPTION	TLA DRAWING	PS DRAWING	SHEET	PART NO.	DATASHEET REV.
MDL,SIN,HDBT,1:1,POEPP,SM,TU	HDX8006NL-P4	PS-2473.001-C	2 OF 3	HDX8006NL	C

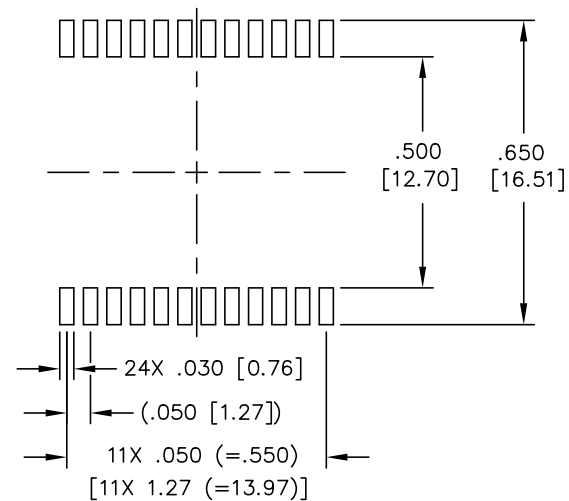
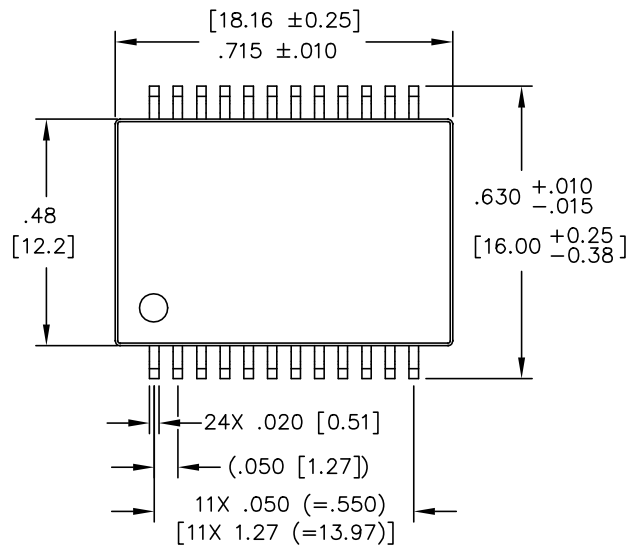

SUGGESTED LAND PATTERN

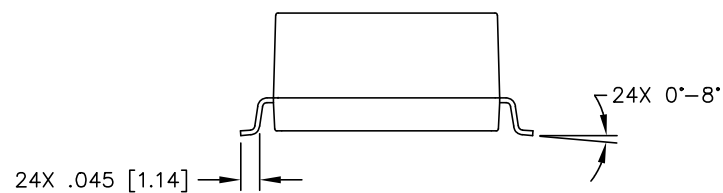
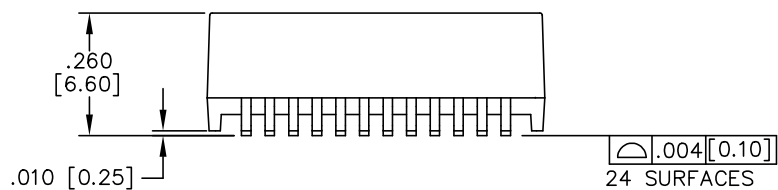

DIMENSIONS ARE IN INCHES [MILLIMETERS] WITH THE FOLLOWING TOLERANCES: [MILLIMETERS] ARE FOR REFERENCE ONLY.
 .XX= ±.01 [±0.25]
 .XXX= ±.005 [±0.13]

© Copyright, 2018. Pulse Electronics Corp. All rights reserved. Pulse confidential & proprietary. (06/29/18)

PRODUCT DESCRIPTION	TLA DRAWING	PS DRAWING	SHEET	PART NO.	DATASHEET REV.
MDL,SIN,HDBT,1:1,POEPP,SM,TU	HDX8006NL-P4	PS-2473.001-C	3 OF 3	HDX8006NL	C

单击下面可查看定价，库存，交付和生命周期等信息

[>>Pulse\(普思\)](#)