

Description: 868MHz Ceramic Chip Antenna

Series: Ceramic Chip Antenna

PART NUMBER: W3013

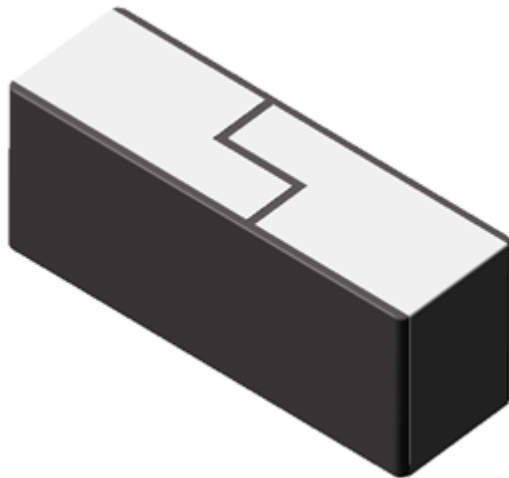

Features:

- Frequency 866-870 MHz
- Gain 1.5dBi
- Size 10 x 3.2 x 4 mm
- PCB Keep out 10.8 x 8.25 mm
- Polarization Linear
- Radiation pattern Omni

Applications:

- ISM 868MHz Band

All dimensions are in mm / inches

Issue: 2036

In the effort to improve our products, we reserve the right to make changes judged to be necessary.

CONFIDENTIAL AND PROPRIETARY INFORMATION

This document contains confidential and proprietary information of Pulse Electronics, Inc. (Pulse) and is protected by copyright, trade secret and other state and federal laws. Its receipt or possession does not convey any rights to reproduce, disclose its contents, or to manufacture, use or sell anything it may describe. Reproduction, disclosure or use without specific written authorization of Pulse is strictly forbidden.

For more information:

Pulse Worldwide Headquarters
15255 Innovation Drive #100
San Diego, CA 92128
USA
Tel: 1-858-674-8100

Pulse/Larsen Antennas
18110 SE 34th St Bldg 2 Suite 250
Vancouver, WA 98683
USA
Tel: 1-360-944-7551

Europe Headquarters
Pulse GmbH & Do, KG
Zeppelinstrasse 15
Herrenberg, Germany

Pulse (Suzhou) Wireless Products Co, Inc.
99 Huo Ju Road(#29 Bldg,4th Phase
Suzhou New District
Jiangsu Province, Suzhou 215009 PR China
Tel: 86 512 6807 9998

Description: 868MHz Ceramic Chip Antenna

Series: Ceramic Chip Antenna

PART NUMBER: W3013

ELECTRICAL SPECIFICATIONS

Antenna Type	Chip antenna
Frequency	868-870MHz
Nominal Impedance	50 Ω
Return Loss (Max)	-10dB
Radiation Pattern	Omn
Gain(Min)	1.5 dBi
Efficiency(Min)	68 %
Polarization	Vertical
Power Withstanding	3W

MECHANICAL SPECIFICATIONS

Compact size	10 x 3.2 x 4mm
Weight	0.6g
Fixing system	SMT
MSL(MOISTURE SENSITIVITY LEVEL)	1

ENVIRONMENTAL SPECIFICATIONS

Operating Temperature	-40 ~ +85° C
Storage Temperature	-10 ~ +30° C
RoHS Compliant	Yes

Description: 868MHz Ceramic Chip Antenna

Series: Ceramic Chip Antenna

PART NUMBER: W3013

MECHANICAL DRAWING

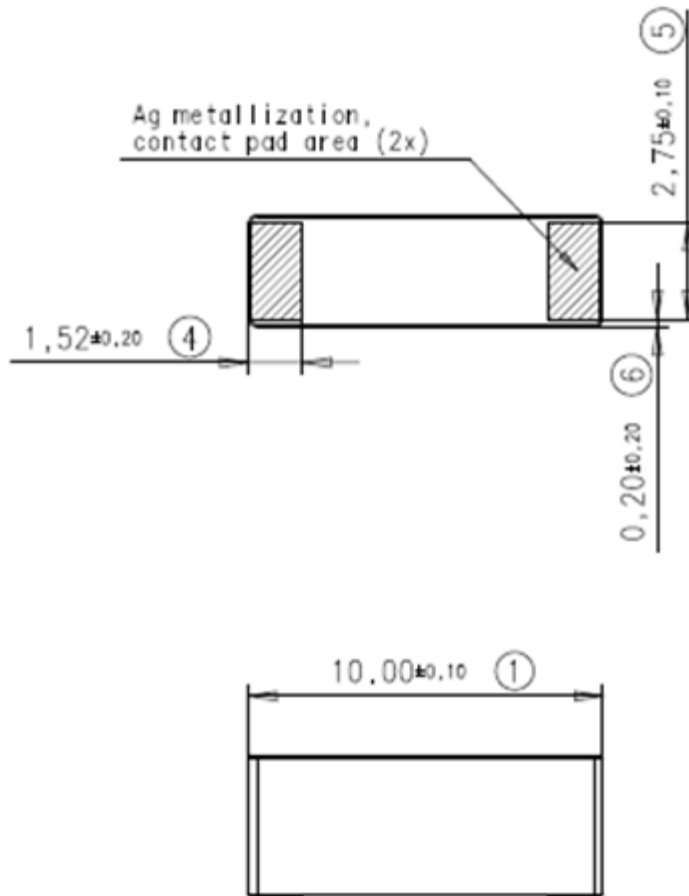

No.	Terminal Name	Terminal Dimensions
1	Feed / GND	1.5 x 2.75 mm
2	Feed / GND	1.5 x 2.75 mm

Antenna is symmetrical. Either of terminals 1 or 2 can be Feed / GND

Issue: 2036

In the effort to improve our products, we reserve the right to make changes judged to be necessary.

CONFIDENTIAL AND PROPRIETARY INFORMATION

This document contains confidential and proprietary information of Pulse Electronics, Inc. (Pulse) and is protected by copyright, trade secret and other state and federal laws. Its receipt or possession does not convey any rights to reproduce, disclose its contents, or to manufacture, use or sell anything it may describe. Reproduction, disclosure or use without specific written authorization of Pulse is strictly forbidden.

Description: 868MHz Ceramic Chip Antenna

Series: Ceramic Chip Antenna

PART NUMBER: W3013

W3011 GPS Antenna PWB Layout

W3013 Antenna PWB Layout Specifications

Ground cleared under antenna, clearance area **10.80 x 8.25 mm**

Matching and tuning component values depend on application and surrounding mechanics / materials.

Feed line should be designed to match 50 Ω characteristic impedance, depending on PWB material and thickness.

Recommended test board layout for electrical characteristic measurement, test board outline size 100 x 37 mm.

PWB layout for W3013 Antenna

Note: All dimensions are in metric system.

Matching Component
(optional shunt)

Feed contact
Ground contact

Ground Area

Ground Via Hole
Ground area should be surrounded with Ground Via Holes

Feed line 50 Ohm
Any type of 50 Ohm feed line can be used. Inner layers on feed line area need to be designed to give 50 Ohm characteristics to feed line.

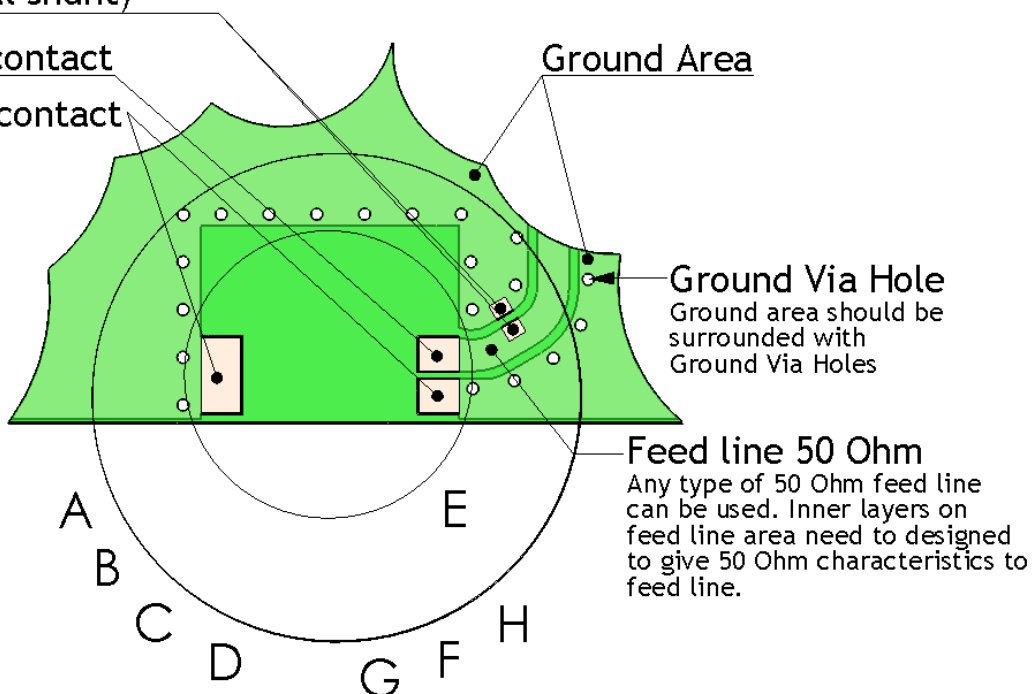

Issue: 2036

In the effort to improve our products, we reserve the right to make changes judged to be necessary.

CONFIDENTIAL AND PROPRIETARY INFORMATION

This document contains confidential and proprietary information of Pulse Electronics, Inc. (Pulse) and is protected by copyright, trade secret and other state and federal laws. Its receipt or possession does not convey any rights to reproduce, disclose its contents, or to manufacture, use or sell anything it may describe. Reproduction, disclosure or use without specific written authorization of Pulse is strictly forbidden.

Description: 868MHz Ceramic Chip Antenna

Series: Ceramic Chip Antenna

PART NUMBER: W3013

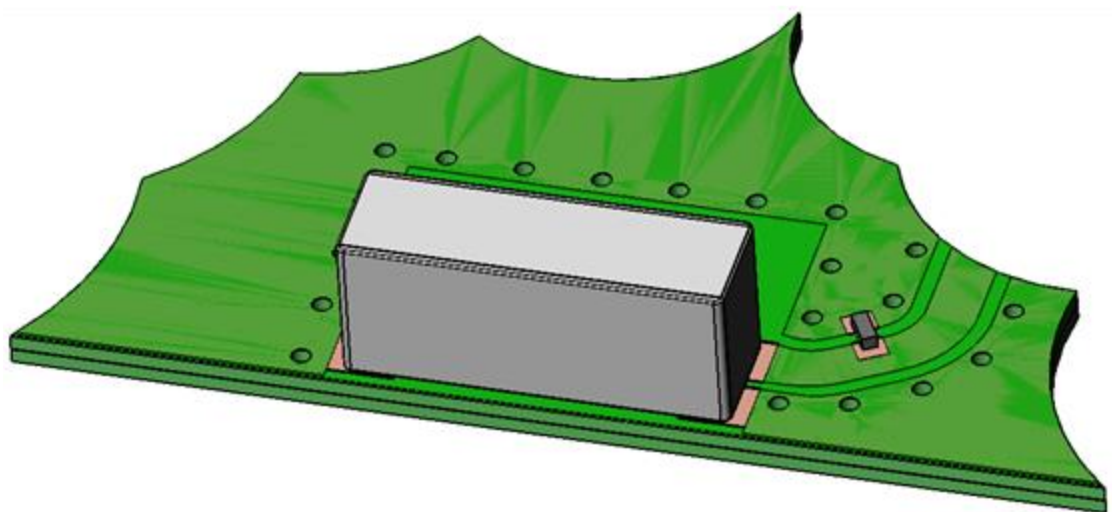

Ground clearance area for W3013 Antenna

Ground clearance area (10.80 x 8.25 mm)

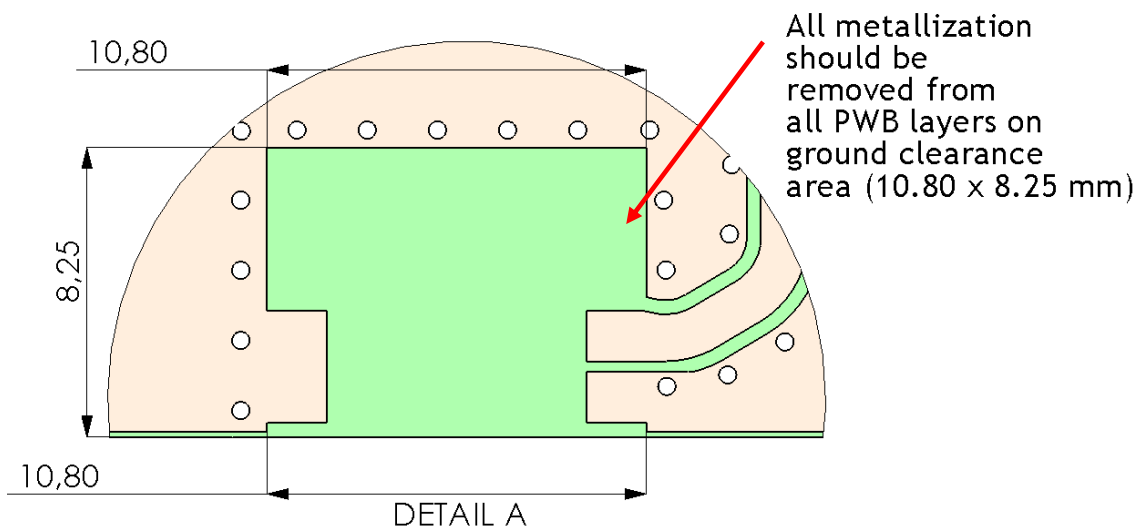

Issue: 2036

In the effort to improve our products, we reserve the right to make changes judged to be necessary.

CONFIDENTIAL AND PROPRIETARY INFORMATION

This document contains confidential and proprietary information of Pulse Electronics, Inc. (Pulse) and is protected by copyright, trade secret and other state and federal laws. Its receipt or possession does not convey any rights to reproduce, disclose its contents, or to manufacture, use or sell anything it may describe. Reproduction, disclosure or use without specific written authorization of Pulse is strictly forbidden.

Description: 868MHz Ceramic Chip Antenna

Series: Ceramic Chip Antenna

PART NUMBER: W3013

Opening in bottom/inner ground layers

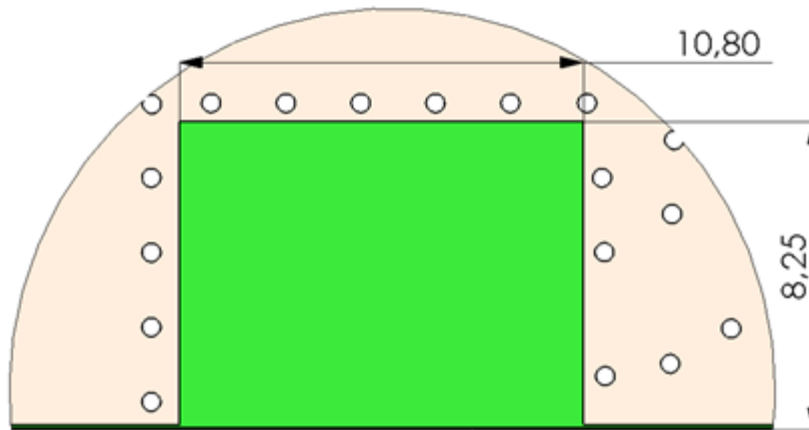

DETAIL B

Opening in other layers (no ground/ RF)

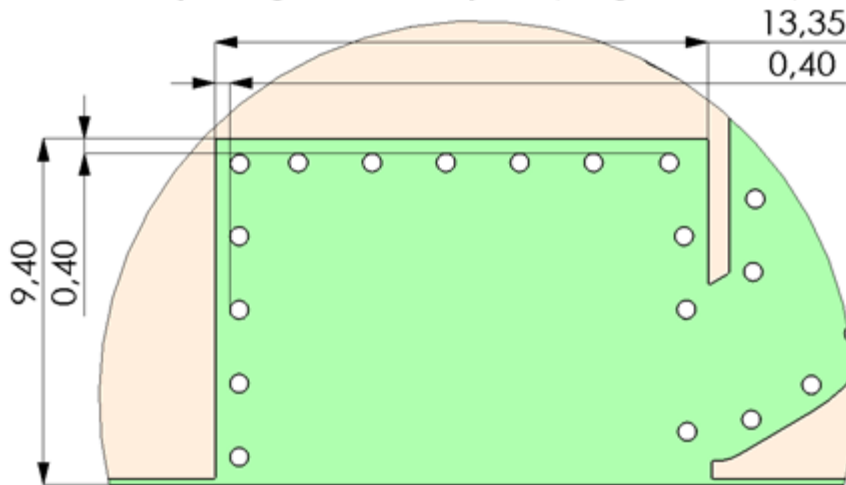

DETAIL C

Issue: 2036

In the effort to improve our products, we reserve the right to make changes judged to be necessary.

CONFIDENTIAL AND PROPRIETARY INFORMATION

This document contains confidential and proprietary information of Pulse Electronics, Inc. (Pulse) and is protected by copyright, trade secret and other state and federal laws. Its receipt or possession does not convey any rights to reproduce, disclose its contents, or to manufacture, use or sell anything it may describe. Reproduction, disclosure or use without specific written authorization of Pulse is strictly forbidden.

Description: 868MHz Ceramic Chip Antenna

Series: Ceramic Chip Antenna

PART NUMBER: W3013

PWB pad dimensions and antenna position for W3013 Antenna

Pad dimensions in top copper

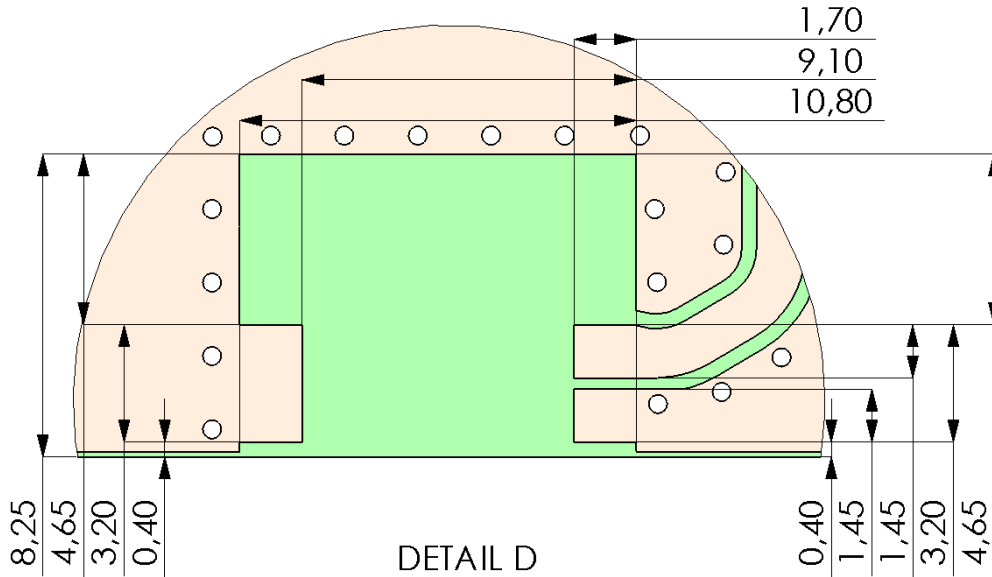

Antenna position on PWB layout

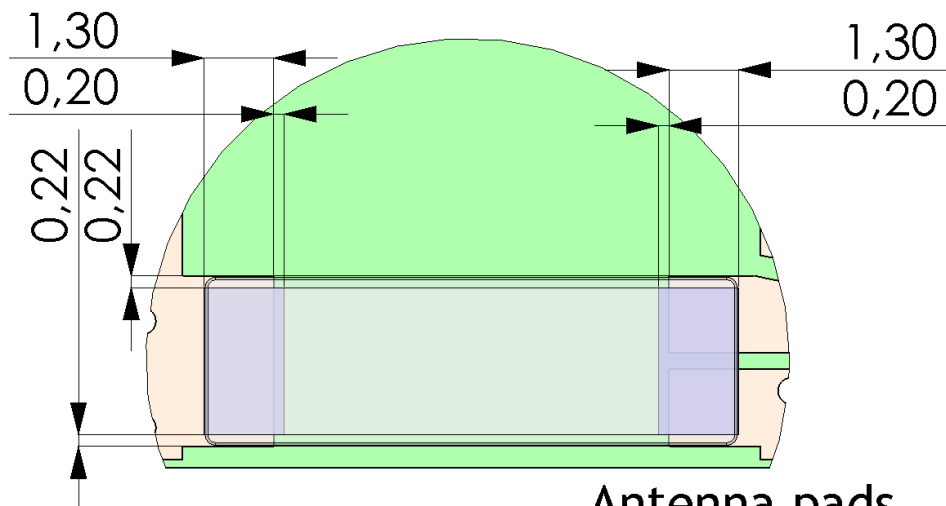

Antenna pads
are marked blue

Issue: 2036

In the effort to improve our products, we reserve the right to make changes judged to be necessary.

CONFIDENTIAL AND PROPRIETARY INFORMATION

This document contains confidential and proprietary information of Pulse Electronics, Inc. (Pulse) and is protected by copyright, trade secret and other state and federal laws. Its receipt or possession does not convey any rights to reproduce, disclose its contents, or to manufacture, use or sell anything it may describe. Reproduction, disclosure or use without specific written authorization of Pulse is strictly forbidden.

Description: 868MHz Ceramic Chip Antenna

Series: Ceramic Chip Antenna

PART NUMBER: W3013

Typical ground via hole placement in PWB layout for W3013 Antenna

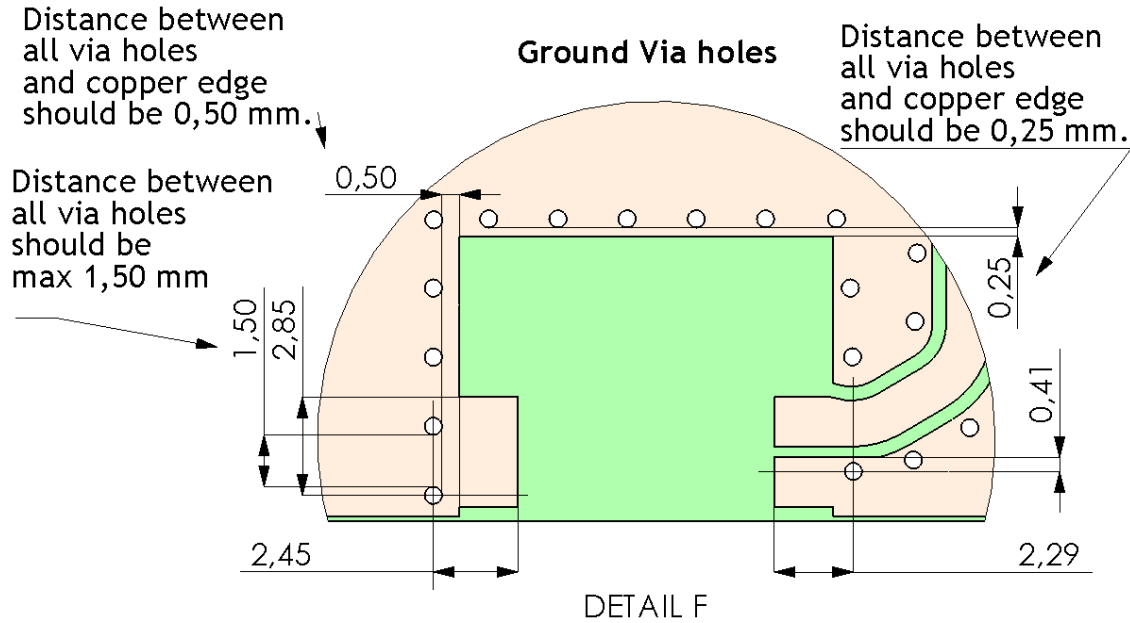

Solder resist opening and Paste stencil recommendation for W3013 Antenna

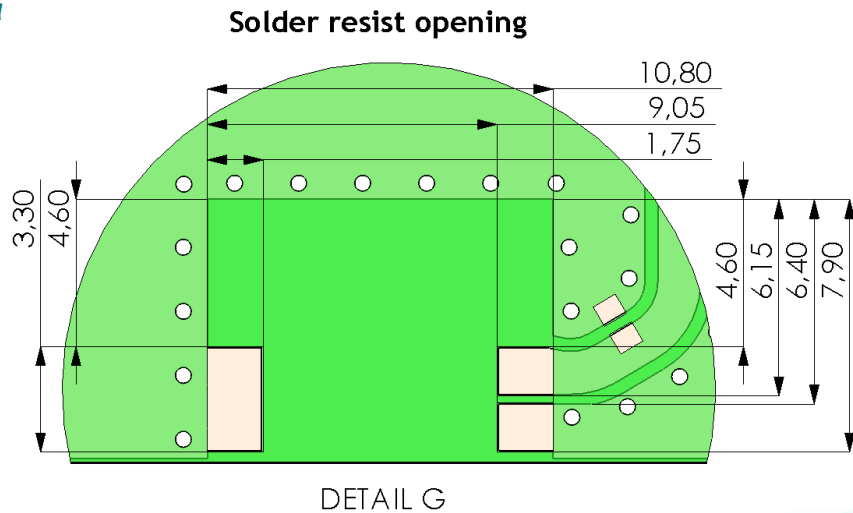

Issue: 2036

In the effort to improve our products, we reserve the right to make changes judged to be necessary.

CONFIDENTIAL AND PROPRIETARY INFORMATION

This document contains confidential and proprietary information of Pulse Electronics, Inc. (Pulse) and is protected by copyright, trade secret and other state and federal laws. Its receipt or possession does not convey any rights to reproduce, disclose its contents, or to manufacture, use or sell anything it may describe. Reproduction, disclosure or use without specific written authorization of Pulse is strictly forbidden.

Description: 868MHz Ceramic Chip Antenna

Series: Ceramic Chip Antenna

PART NUMBER: W3013

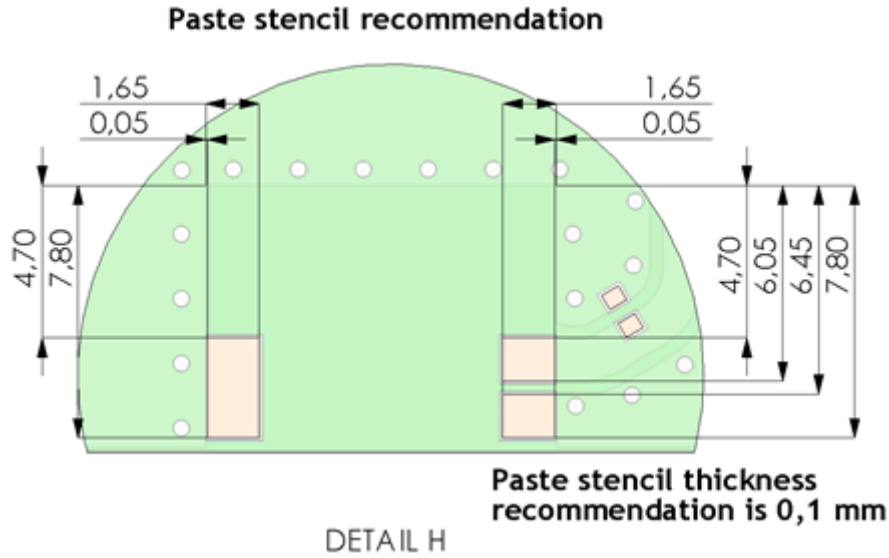

Issue: 2036

In the effort to improve our products, we reserve the right to make changes judged to be necessary.

CONFIDENTIAL AND PROPRIETARY INFORMATION

This document contains confidential and proprietary information of Pulse Electronics, Inc. (Pulse) and is protected by copyright, trade secret and other state and federal laws. Its receipt or possession does not convey any rights to reproduce, disclose its contents, or to manufacture, use or sell anything it may describe. Reproduction, disclosure or use without specific written authorization of Pulse is strictly forbidden.

Description: 868MHz Ceramic Chip Antenna

Series: Ceramic Chip Antenna

PART NUMBER: W3013

Recommended antenna position on PWB for W3013 Antenna

Our test PWB size is 37 x 100 mm, other sized boards can be used depending on customer device size (minimum 35 x 35 mm)

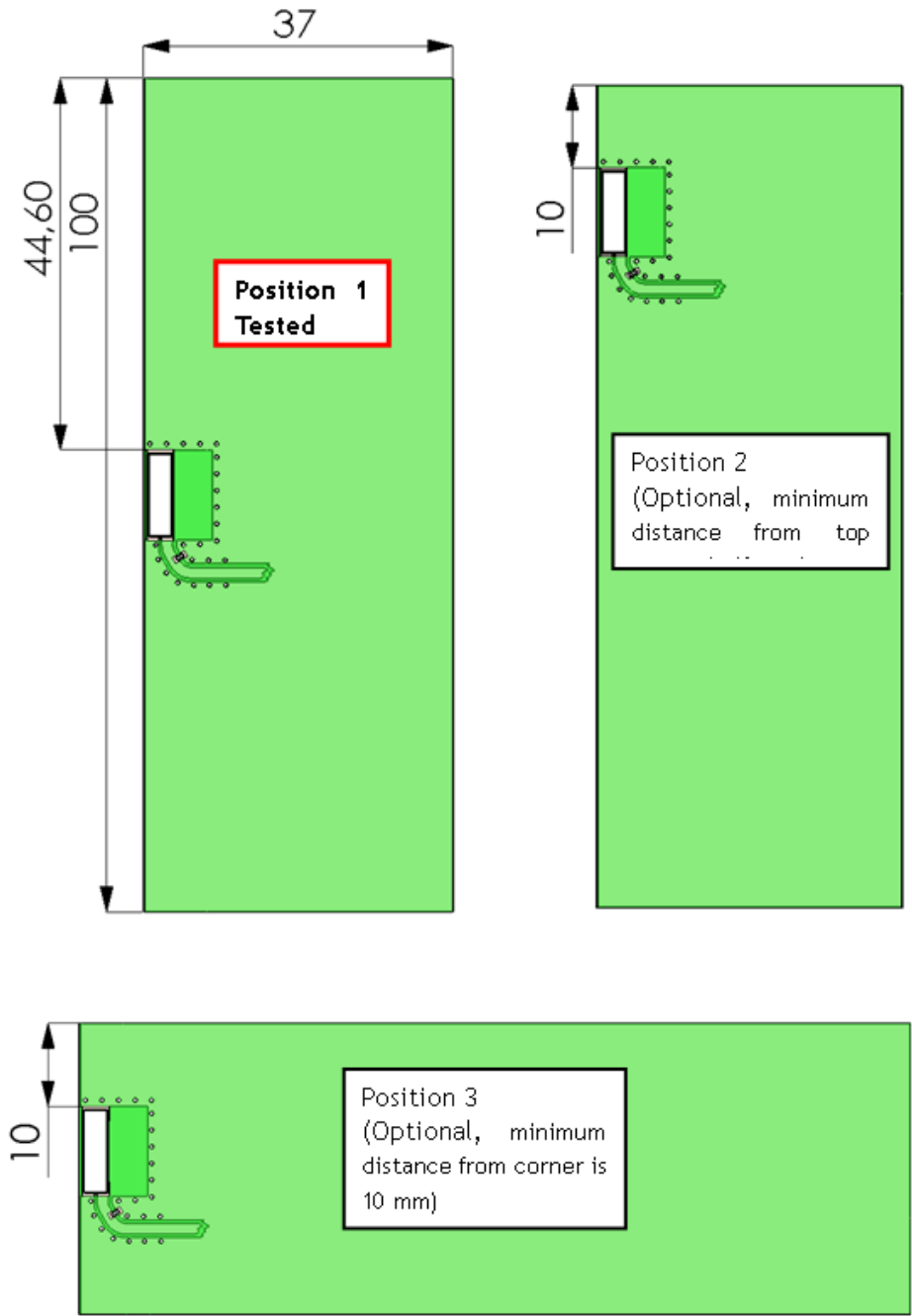

Issue: 2036

In the effort to improve our products, we reserve the right to make changes judged to be necessary.

CONFIDENTIAL AND PROPRIETARY INFORMATION

This document contains confidential and proprietary information of Pulse Electronics, Inc. (Pulse) and is protected by copyright, trade secret and other state and federal laws. Its receipt or possession does not convey any rights to reproduce, disclose its contents, or to manufacture, use or sell anything it may describe. Reproduction, disclosure or use without specific written authorization of Pulse is strictly forbidden.

Description: 868MHz Ceramic Chip Antenna

Series: Ceramic Chip Antenna

PART NUMBER: W3013

GHARTS

Typical Electrical Characteristics (T=25 °C)

Measured on the 100 x 37mm test board with 3 pF matching capacitor.

Typical Return Loss S11/ impedance

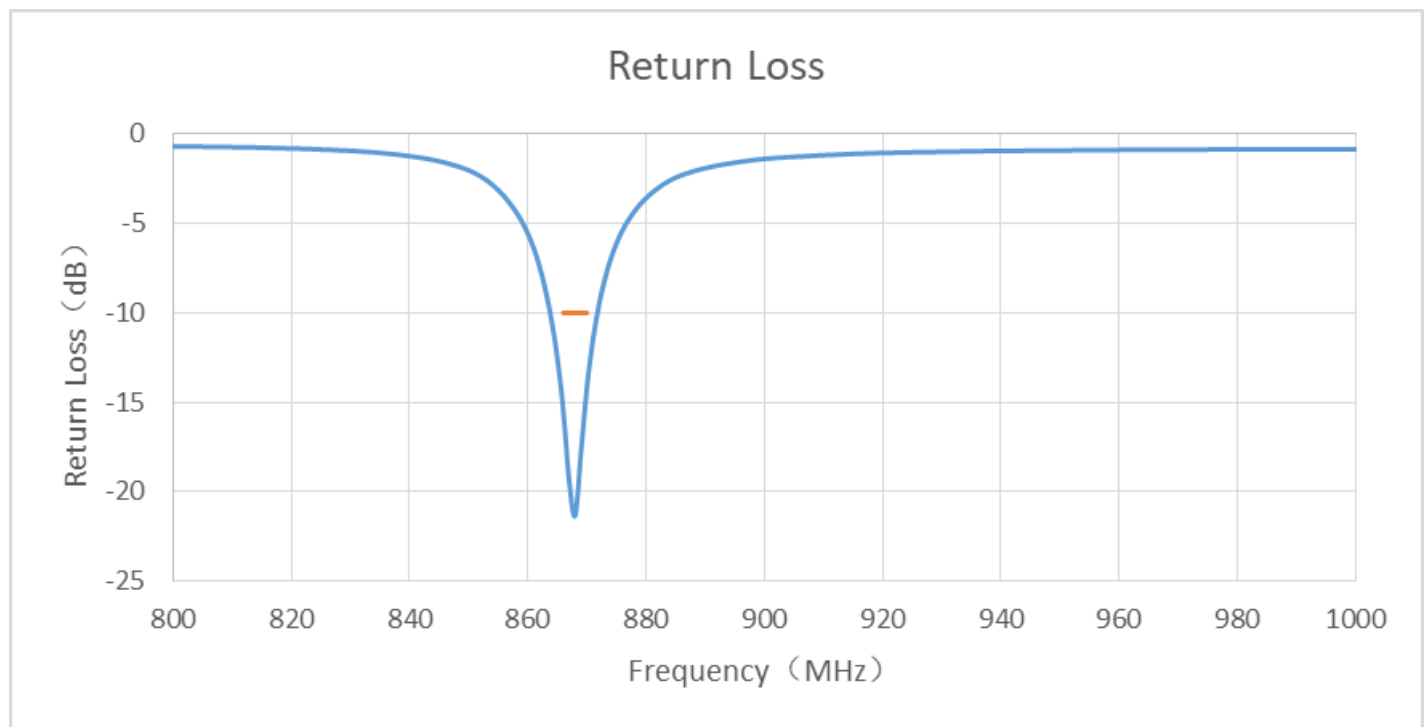

Issue: 2036

In the effort to improve our products, we reserve the right to make changes judged to be necessary.

CONFIDENTIAL AND PROPRIETARY INFORMATION

This document contains confidential and proprietary information of Pulse Electronics, Inc. (Pulse) and is protected by copyright, trade secret and other state and federal laws. Its receipt or possession does not convey any rights to reproduce, disclose its contents, or to manufacture, use or sell anything it may describe. Reproduction, disclosure or use without specific written authorization of Pulse is strictly forbidden.

Description: 868MHz Ceramic Chip Antenna

Series: Ceramic Chip Antenna

PART NUMBER: W3013

CHARTS

Gain

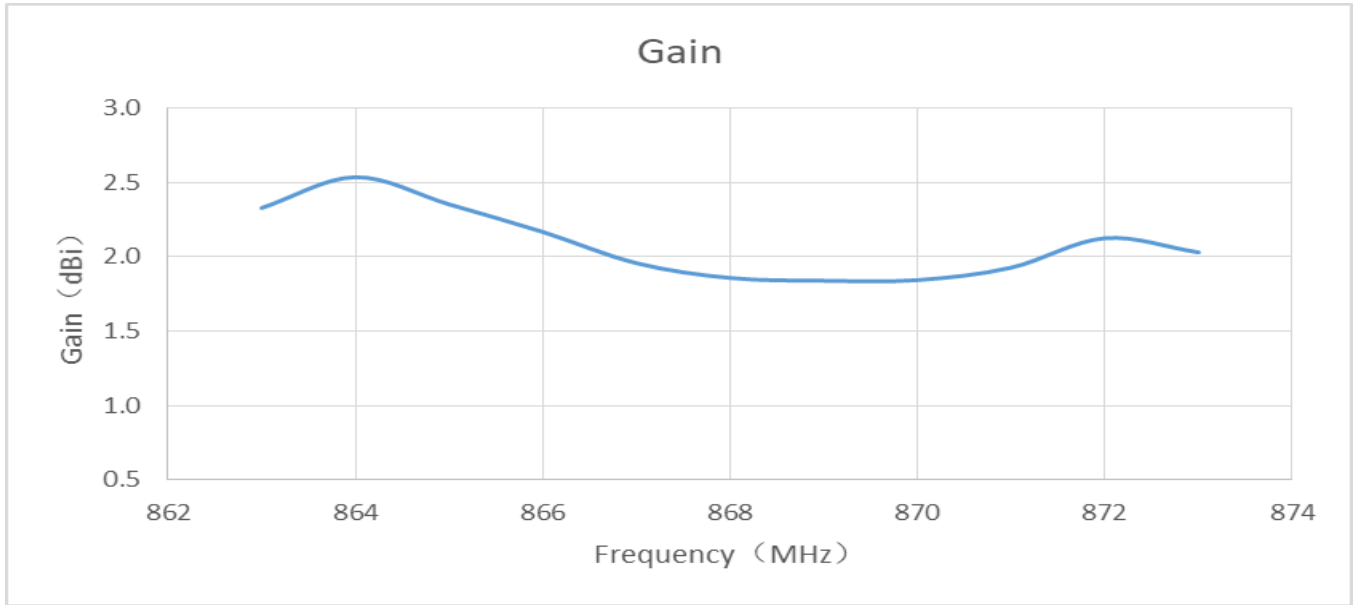

Radiation Efficiency

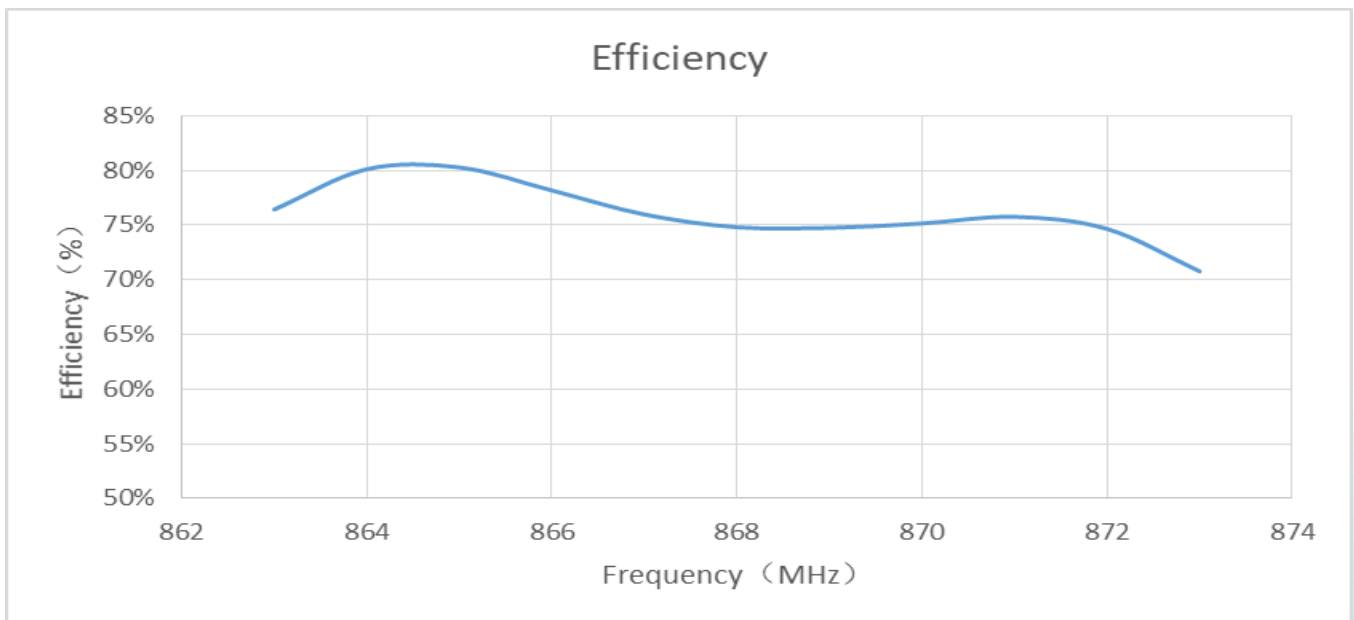

Issue: 2036

In the effort to improve our products, we reserve the right to make changes judged to be necessary.

CONFIDENTIAL AND PROPRIETARY INFORMATION

This document contains confidential and proprietary information of Pulse Electronics, Inc. (Pulse) and is protected by copyright, trade secret and other state and federal laws. Its receipt or possession does not convey any rights to reproduce, disclose its contents, or to manufacture, use or sell anything it may describe. Reproduction, disclosure or use without specific written authorization of Pulse is strictly forbidden.

Description: 868MHz Ceramic Chip Antenna

Series: Ceramic Chip Antenna

PART NUMBER: W3013

CHARTS

XY Plane

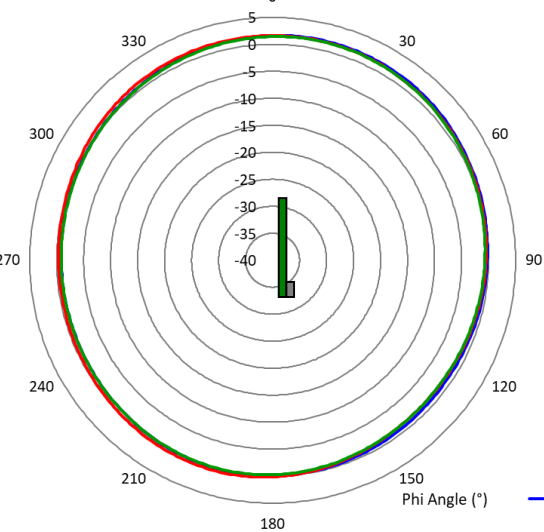

863MHz
Avg(dBi) = 0.20
Peak(dBi) = 1.81
Avg -3(deg) = 359.5

868MHz
Avg (dBi) = 0.32
Peak (dBi) = 1.63
Avg -3 (deg) = 358.5

873MHz
Avg (dBi) = -0.04
Peak (dBi) = 1.55
Avg -3 (deg) = 359.5

— 863MHz — 868MHz — 873MHz

ZX Plane

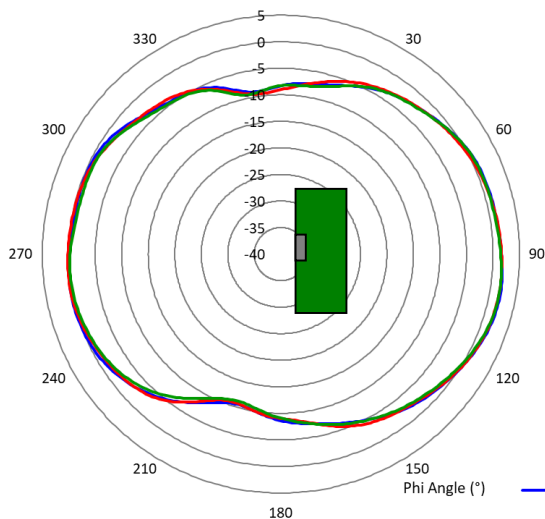

863MHz
Avg(dBi) = -1.87
Peak(dBi) = 2.05
Avg -3(deg) = 142.5

868MHz
Avg (dBi) = -1.96
Peak (dBi) = 1.81
Avg -3 (deg) = 136.5

873MHz
Avg (dBi) = -2.20
Peak (dBi) = 1.84
Avg -3 (deg) = 134.5

— 863MHz — 868MHz — 873MHz

YZ Plane

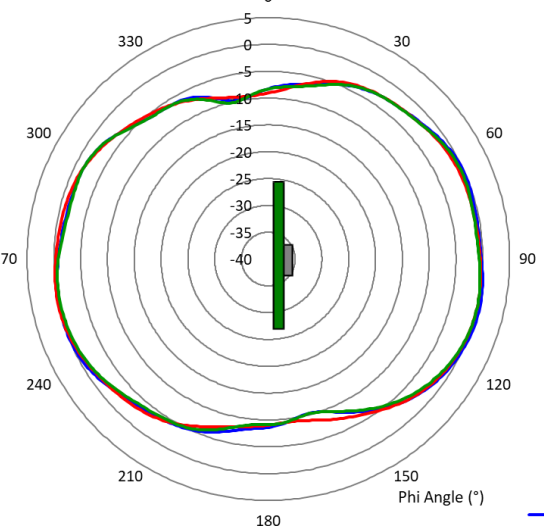

863MHz
Avg(dBi) = -2.67
Peak(dBi) = 0.46
Avg -3(deg) = 168.5

868MHz
Avg (dBi) = -2.76
Peak (dBi) = 0.10
Avg -3 (deg) = 180.5

873MHz
Avg (dBi) = -2.98
Peak (dBi) = -0.01
Avg -3 (deg) = 176.5

— 863MHz — 868MHz — 873MHz

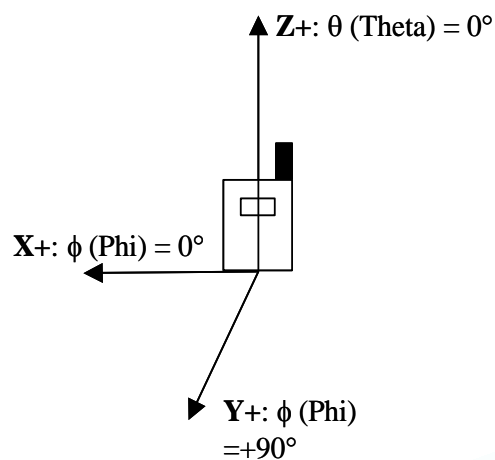

Issue: 2036

In the effort to improve our products, we reserve the right to make changes judged to be necessary.

CONFIDENTIAL AND PROPRIETARY INFORMATION

This document contains confidential and proprietary information of Pulse Electronics, Inc. (Pulse) and is protected by copyright, trade secret and other state and federal laws. Its receipt or possession does not convey any rights to reproduce, disclose its contents, or to manufacture, use or sell anything it may describe. Reproduction, disclosure or use without specific written authorization of Pulse is strictly forbidden.

Description: 868MHz Ceramic Chip Antenna

Series: Ceramic Chip Antenna

PART NUMBER: W3013

Recommendations for ceramic chip antenna storage

Storage time

Products should be used within 6 months from the day of manufacturers packaging even when they are stored under below mentioned conditions. Longer storage period may decrease the component solderability.

Storage environmental conditions

To maintain solderability of Pulse ceramic products care must be taken to control the storage and use conditions:

- Do not store or use products in a corrosive atmosphere, especially where chloride, sulphur or sulfide, alkali or acid salts exist in the air. Corrosive gases may cause oxidation of electrodes and reduce solderability
- Keep temperature and humidity stable and do not exceed the below mentioned minimum and maximum conditions: Temperature: -10 to +30 Deg C
Humidity: below 60% RH
- Do not store the products under direct sun light.

It is recommended to keep the products in manufacturers packing (tape&reel) until the time of assembly and soldering process. Air tight vacuum package is recommended in the conditions where it is know to be some corrosive gases.

Handling

Do not touch the components with bare hands. Protective gloves must be used to prevent contamination of terminals which may cause reduced solderability. Do not touch or damage the silver plated surface by any sharp objects. Soft materials (plastic, wood etc.) must be used if tweezers or other tools are used to pick the components. Avoid any excess mechanical shock or vibration during storage and handling.

Issue: 2036

In the effort to improve our products, we reserve the right to make changes judged to be necessary.

CONFIDENTIAL AND PROPRIETARY INFORMATION

This document contains confidential and proprietary information of Pulse Electronics, Inc. (Pulse) and is protected by copyright, trade secret and other state and federal laws. Its receipt or possession does not convey any rights to reproduce, disclose its contents, or to manufacture, use or sell anything it may describe. Reproduction, disclosure or use without specific written authorization of Pulse is strictly forbidden.

Downloaded From Oneyac.com

Description: 868MHz Ceramic Chip Antenna

Series: Ceramic Chip Antenna

PART NUMBER: W3013

Recommendation for reflow soldering process

Printing stencil thickness 0,15 - 0,25 mm is recommended for the solder paste. The maximum soldering temperature should not exceed 260°C. The temperature profile recommendations for reflow soldering process is presented in the Figures 1 and 2. The reflow profile

presented in figure 1 describes minimum reflow temperatures. The reflow profile presented in figure 2 describes maximum reflow temperatures. located at the center of the coverage area.

	Method of heat transfer	Controlled hot air convection
1	Average temperature gradient in preheating	2.5 °C/s
2	Soak time	2-3 minutes
3	Max temperature gradient in reflow	3 °C/s
4	Time above 217 °C	Max 30 sec
5	Peak temperature in reflow	230 °C for 10 seconds
6	Temperature gradient in cooling	Max -5 °C/s

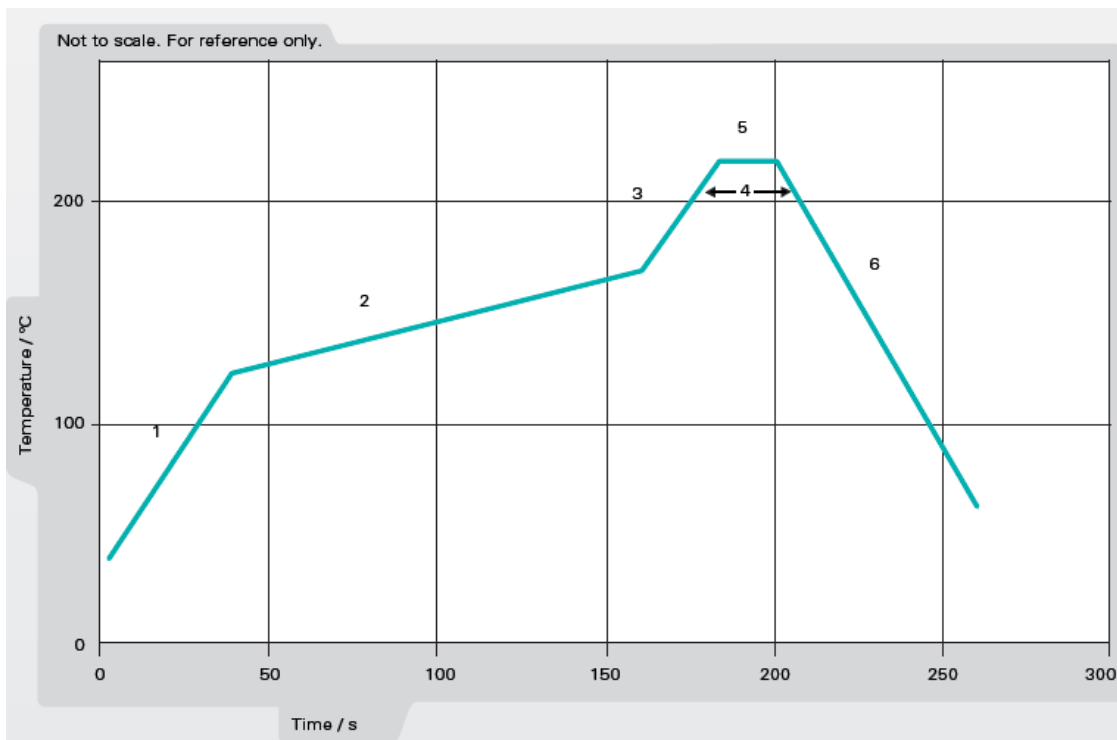

Figure 1. Minimum temperature profile recommendation for reflow soldering process

Issue: 2036

In the effort to improve our products, we reserve the right to make changes judged to be necessary.

CONFIDENTIAL AND PROPRIETARY INFORMATION

This document contains confidential and proprietary information of Pulse Electronics, Inc. (Pulse) and is protected by copyright, trade secret and other state and federal laws. Its receipt or possession does not convey any rights to reproduce, disclose its contents, or to manufacture, use or sell anything it may describe. Reproduction, disclosure or use without specific written authorization of Pulse is strictly forbidden.

Description: 868MHz Ceramic Chip Antenna

Series: Ceramic Chip Antenna

PART NUMBER: W3013

Recommendation for reflow soldering process

	Method of heat transfer	Controlled hot air convection
1	Average temperature gradient in preheating	2.5 °C/s
2	Soak time	2-3 minutes
3	Max temperature gradient in reflow	3 °C/s
4	Time above 217 °C	Max 60 sec
5	Time above 230 °C	Max 50 sec
6	Time above 250 °C	Max 10 sec
7	Peak temperature in reflow	260 °C for 5 seconds
8	Temperature gradient in cooling	Max -5 °C/s

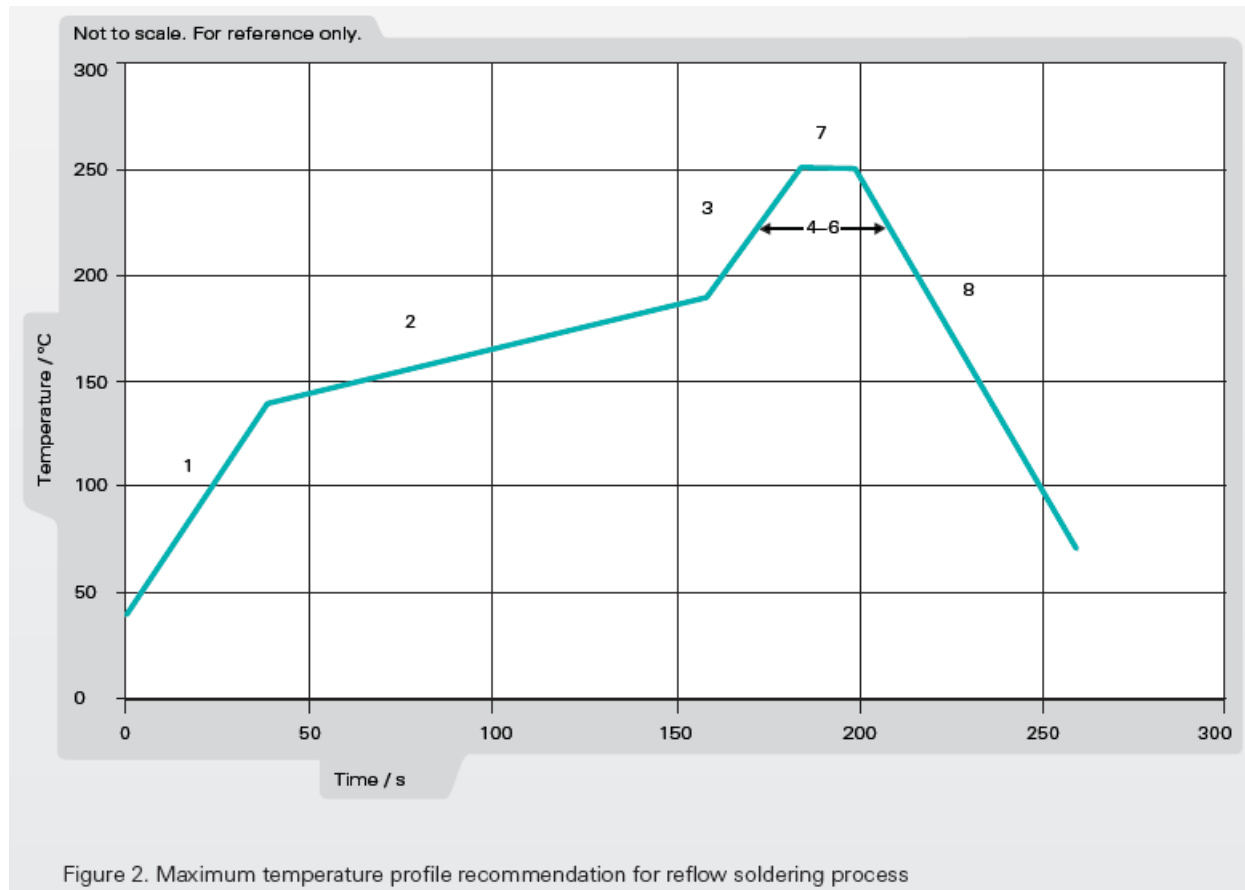

Issue: 2036

In the effort to improve our products, we reserve the right to make changes judged to be necessary.

CONFIDENTIAL AND PROPRIETARY INFORMATION

This document contains confidential and proprietary information of Pulse Electronics, Inc. (Pulse) and is protected by copyright, trade secret and other state and federal laws. Its receipt or possession does not convey any rights to reproduce, disclose its contents, or to manufacture, use or sell anything it may describe. Reproduction, disclosure or use without specific written authorization of Pulse is strictly forbidden.

Description: 868MHz Ceramic Chip Antenna

Series: Ceramic Chip Antenna

PART NUMBER: W3013

PACKAGING

Packing form

**500pcs in one Reel,
3 reel in one inbox (1500 pcs),
2 inbox in out box (3000pcs)**

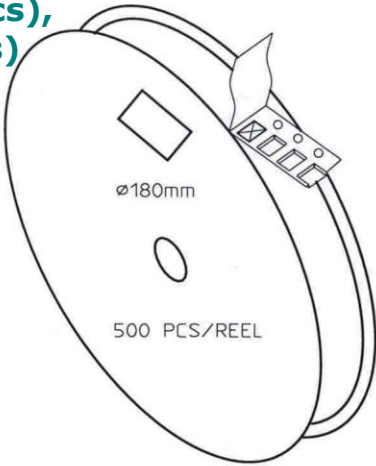

ø180mm
500 PCS/REEL

CARRIER TAPE H85-00158
width=24,00 depth=4.15
COVER TAPE H85-00159
width=21.20

LENGTH OF TAPE:

- Leader section: min 350 mm before component section
- Trailer section: min 40 mm after component section.

Empty part cavities at leader and trailer section of the tape must be sealed with top cover tape.

BOX H85-00128 (182x182x125) 1 pcs
- LABEL 1 pcs/BOX

REEL H85-00160 (D180,W28) 4 pcs
- REEL LABEL 1 pcs/REEL

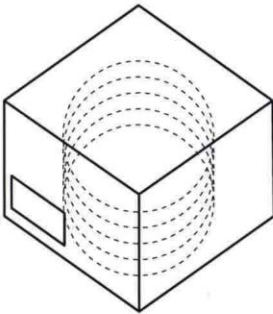

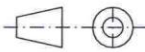
MATERIAL			
HANDLINGS			
		RATIO	DRWN 160107 PeHa H
			DGNER G
			CHKD F
			APPRD E
PRODUCT H90-OY800-F01P01		APPRD BY	D
DENOMINATION PACKING FORM			C
			B
			A
		VERSION	MOD/DATE/NAME

Issue: 2036

In the effort to improve our products, we reserve the right to make changes judged to be necessary.

CONFIDENTIAL AND PROPRIETARY INFORMATION

This document contains confidential and proprietary information of Pulse Electronics, Inc. (Pulse) and is protected by copyright, trade secret and other state and federal laws. Its receipt or possession does not convey any rights to reproduce, disclose its contents, or to manufacture, use or sell anything it may describe. Reproduction, disclosure or use without specific written authorization of Pulse is strictly forbidden.

Description: 868MHz Ceramic Chip Antenna

Series: Ceramic Chip Antenna

PART NUMBER: W3013

PACKAGING

General

Tape and reel packing is used. Carrier tape, reel and box dimensions are presented in following pictures.

Carrier tape

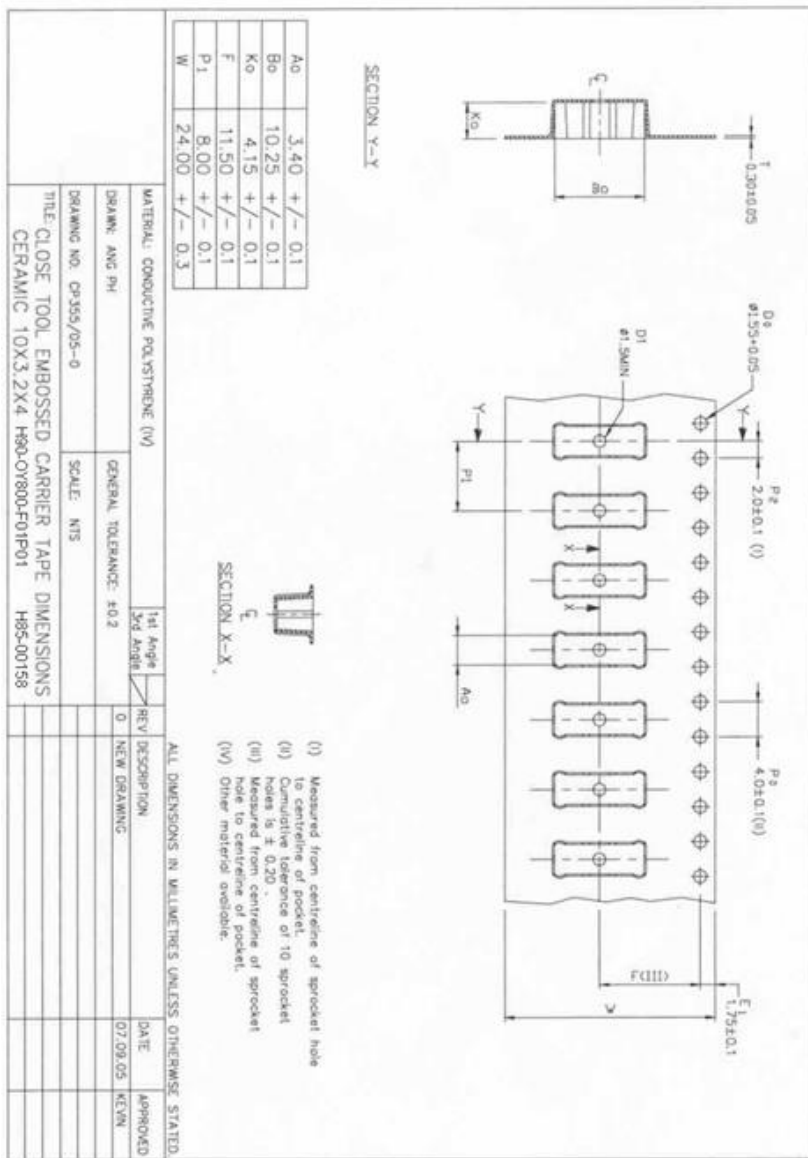

Issue: 2036

In the effort to improve our products, we reserve the right to make changes judged to be necessary.

CONFIDENTIAL AND PROPRIETARY INFORMATION

This document contains confidential and proprietary information of Pulse Electronics, Inc. (Pulse) and is protected by copyright, trade secret and other state and federal laws. Its receipt or possession does not convey any rights to reproduce, disclose its contents, or to manufacture, use or sell anything it may describe. Reproduction, disclosure or use without specific written authorization of Pulse is strictly forbidden.

单击下面可查看定价，库存，交付和生命周期等信息

[>>Pulse\(普思\)](#)