



RAZ52211DM (Black)



RAZ52212DM (White)

Features:

- 2x LTE 644-2700MHz (MiMo)
- 0, 1x, 2x or 3x WiFi 2.4/5GHz
- DSRC
- GNSS Active:
 - Beidou, GPS, Glonass
 - RHCP polarization
 - Amplifier Gain 30dBi
- Size: 88.5 x 195.1 x 92.6mm
3.48 x 7.68 x 3.65 in
- Power withstanding 45W
- Available Models
 - RAZ32011DM = 3 Cable, Black
 - RAZ32012DM = 3 Cable, White
 - RAZ42111DM = 4 Cable, Black
 - RAZ42112DM = 4 Cable, White
 - RAZ52211DM = 5 Cable, Black
 - RAZ52212DM = 5 Cable, White
 - RAZ62311DM = 6 Cable, Black
 - RAZ62312DM = 6 Cable, White

Applications:

- Vehicular use Telematics
- Fleet management
- Trucking
- Navigation, GIS and survey
- Public safety
- Search and Rescue
- Metering, Utility boxes

Issue: 1827

In the effort to improve our products, we reserve the right to make changes judged to be necessary.

CONFIDENTIAL AND PROPRIETARY INFORMATION

This document contains confidential and proprietary information of Pulse Electronics, Inc. (Pulse) and is protected by copyright, trade secret and other state and federal laws. Its receipt or possession does not convey any rights to reproduce, disclose its contents, or to manufacture, use or sell anything it may describe. Reproduction, disclosure or use without specific written authorization of Pulse is strictly forbidden.

For more information:

Pulse Worldwide Headquarters
15255 Innovation Drive #100
San Diego, CA 92128
USA
Tel: 1-858-674-8100

Pulse/Larsen Antennas
18110 SE 34th St Bldg 2 Suite 250
Vancouver, WA 98683
USA
Tel: 1-360-944-7551

Europe Headquarters
Pulse GmbH & Do, KG
Zeppelinstrasse 15
Herrenberg, Germany

Pulse (Suzhou) Wireless Products Co, Inc.
99 Huo Ju Road(#29 Bldg,4th Phase
Suzhou New District
Jiangsu Province, Suzhou 215009 PR China
Tel: 86 512 6807 9998

Series: RAZORBACK

PART NUMBER: RAZ32011DM, RAZ32012DM, RAZ42111DM,
RAZ42112DM, RAZ52211DM, RAZ52212DM, RAZ62311DM, RAZ62312DM

ELECTRICAL SPECIFICATIONS

Antenna Type	Monopole, measured on Ø1.02m (40") ground plane
Frequency (2x LTE)	644-960/1710-2700 MHz
Frequency (1x, 2x or 3x WiFi)	2400-2500/4900-5925 MHz
Nominal Impedance	50 Ω
VSWR	2:1
Radiation Pattern	Omni
HPBW / Vertical Plane (LTE, 644-960)	42°
HPBW / Vertical Plane (LTE, 1710-2700)	31°
HPBW / Vertical Plane (WIFI, 2400-2500)	25°
HPBW / Vertical Plane (WIFI, 4900-5925)	20°
Polarization	Vertical
Average Peak Gain (LTE, 644-960) (LTE, 1710-2700)	4.6/4.9 dBi
Average Peak Gain (WIFI, 2400-2500) (WIFI, 4900-5925)	6/6.6 dBi
Isolation (LTE1 to LTE2)	<-13
Isolation (WiFi1/2, WiF2/3 & WiFi1/3)	<-13
Average Efficiency (LTE)	67 %
Average Efficiency (WiFi)	57 %
Power Withstanding	45 W
GNSS Beidou-GPS-Glonass	
Frequency	1561.098±2.046,1575.42±1.023,1602.5625±4 MHz
VSWR	2:1
Nominal Impedance	50 Ω
Gain (Radiating element)	1 dBic +/- 1dB
Gain (LNA gain)	30 dB +/- 2 dB
Polarization	RHCP

Issue: 1827

In the effort to improve our products, we reserve the right to make changes judged to be necessary.

CONFIDENTIAL AND PROPRIETARY INFORMATION

This document contains confidential and proprietary information of Pulse Electronics, Inc. (Pulse) and is protected by copyright, trade secret and other state and federal laws. Its receipt or possession does not convey any rights to reproduce, disclose its contents, or to manufacture, use or sell anything it may describe. Reproduction, disclosure or use without specific written authorization of Pulse is strictly forbidden. Downloaded From Oneyac.com

Description: GNSS/2x LTE/0, 1x, 2x or 3x WiFi
Direct Mount

Series: RAZORBACK

PART NUMBER: RAZ32011DM, RAZ32012DM, RAZ42111DM,
RAZ42112DM, RAZ52211DM, RAZ52212DM, RAZ62311DM, RAZ62312DM

ELECTRICAL SPECIFICATIONS

Out of Band Rejection	960MHz >65 dB, 1710MHz >60 dB, 2170MHz >65 dB, 2400MHz >65 dB
Noise Figure	< 2.4dB
Operating Voltage	3.3 - 5 Vdc ± 0.5 V
Current Consumption	< 11 mA

MECHANICAL SPECIFICATIONS

Length/Height/Width	195.1mm (7.68")/92.6 (3.65")/88.5mm (3.48")
Weight	856 g (1.9 lbs)
Antenna Color / Material	Black or White / PC/ABS, UV protected
Cable / Connector	2x LTE, 5.2m (17') LMR-195/SMA-Male 1x, 2x or 3x WiFi, 5.2m (17') LMR-195/RP-SMA-Male GNSS, 5.2m (17') RG-174/SMA-Male
Mounting Configuration	Ø22.3mm (7/8") Hole required

ENVIRONMENTAL SPECIFICATIONS

Operating Temperature	-40/+85° C
Ingress Protection	IP67
RoHS Compliant	Yes

OTHER SPECIFICATIONS

Total cable assembly loss for 5.2m (17') LMR-195 @ 850MHz	2.1 dB
Total cable assembly loss for 5.2m (17') RG-174 @ 1575MHz	6.0 dB
Total cable assembly loss for 5.2m (17') LMR-195 @ 1930MHz	3.2 dB
Total cable assembly loss for 5.2m (17') LMR-195 @ 2500MHz	3.7 dB
Total cable assembly loss for 5.2m (17') LMR-195 @ 2450MHz	3.6 dB
Total cable assembly loss for 5.2m (17') LMR-195 @ 5350MHz	5.5 dB

Issue: 1827

In the effort to improve our products, we reserve the right to make changes judged to be necessary.

CONFIDENTIAL AND PROPRIETARY INFORMATION

This document contains confidential and proprietary information of Pulse Electronics, Inc. (Pulse) and is protected by copyright, trade secret and other state and federal laws. Its receipt or possession does not convey any rights to reproduce, disclose its contents, or to manufacture, use or sell anything it may describe. Reproduction, disclosure or use without specific written authorization of Pulse is strictly forbidden.

MECHANICAL DRAWING

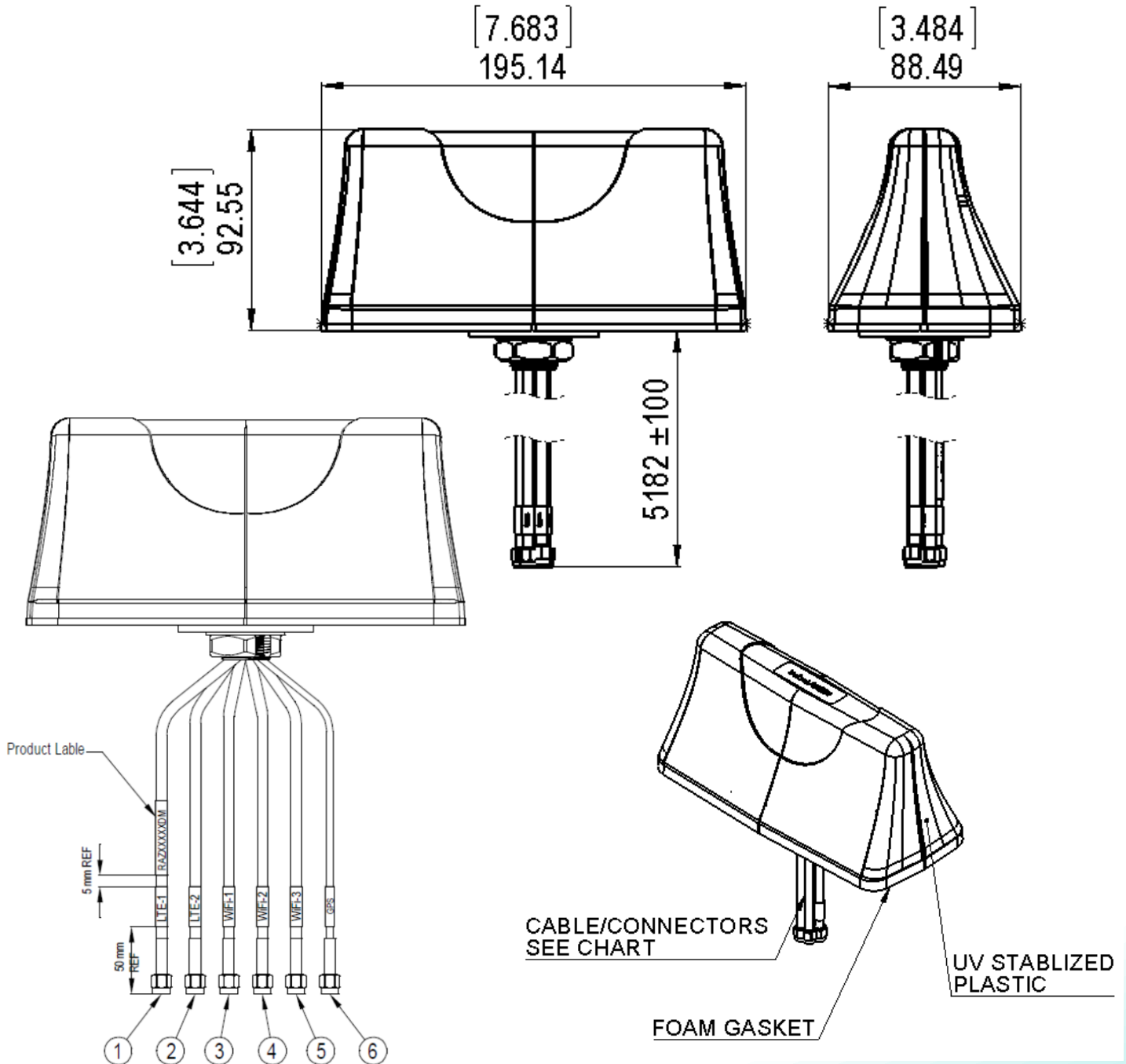

All dimensions are in mm / inches

Issue: 1827

In the effort to improve our products, we reserve the right to make changes judged to be necessary.

CONFIDENTIAL AND PROPRIETARY INFORMATION

This document contains confidential and proprietary information of Pulse Electronics, Inc. (Pulse) and is protected by copyright, trade secret and other state and federal laws. Its receipt or possession does not convey any rights to reproduce, disclose its contents, or to manufacture, use or sell anything it may describe. Reproduction, disclosure or use without specific written authorization of Pulse is strictly forbidden.

Series: RAZORBACK

PART NUMBER: RAZ32011DM, RAZ32012DM, RAZ42111DM,
RAZ42112DM, RAZ52211DM, RAZ52212DM, RAZ62311DM, RAZ62312DM

MECHANICAL DRAWING

Vehicular Multiband Antenna with Direct Mount

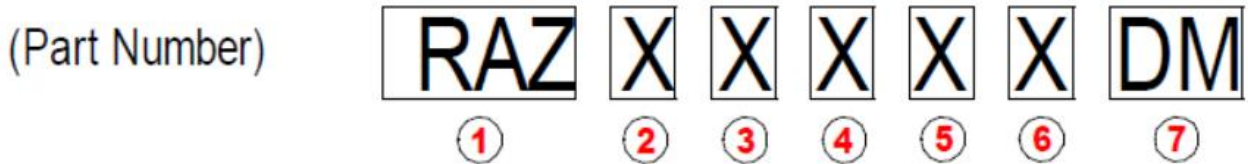

①	Product ID: RAZORBACK
②	Total Number of Cable leads
③	Total Number of LTE Cable Leads
④	Total Number of WiFi Cable Leads
⑤	Total Number of GPS Cable Leads
⑥	The Color of the Plastic Housing 1=Black; 2= White
⑦	Mounting: Direct Mount; 7/8" Hole Required

RAZXXXXDM		CABLE	CABLE LENGTH	CONNECTOR
1	LTE-1 Cable Assy	LMR195	5181 mm / 204" / 17 FT	SMA Male
2	LTE-2 Cable Assy			RP-SMA Male
3	WiFi-1 Cable Assy			
4	WiFi-2 Cable Assy			
5	WiFi-3 Cable Assy	RG-174	SMA Male	
6	GPS Cable Assy			

All dimensions are in mm / inches

Issue: 1827

In the effort to improve our products, we reserve the right to make changes judged to be necessary.

CONFIDENTIAL AND PROPRIETARY INFORMATION

This document contains confidential and proprietary information of Pulse Electronics, Inc. (Pulse) and is protected by copyright, trade secret and other state and federal laws. Its receipt or possession does not convey any rights to reproduce, disclose its contents, or to manufacture, use or sell anything it may describe. Reproduction, disclosure or use without specific written authorization of Pulse is strictly forbidden.

CHARTS

LTE 1 & 2
Measured with 5.2m
(17') cable

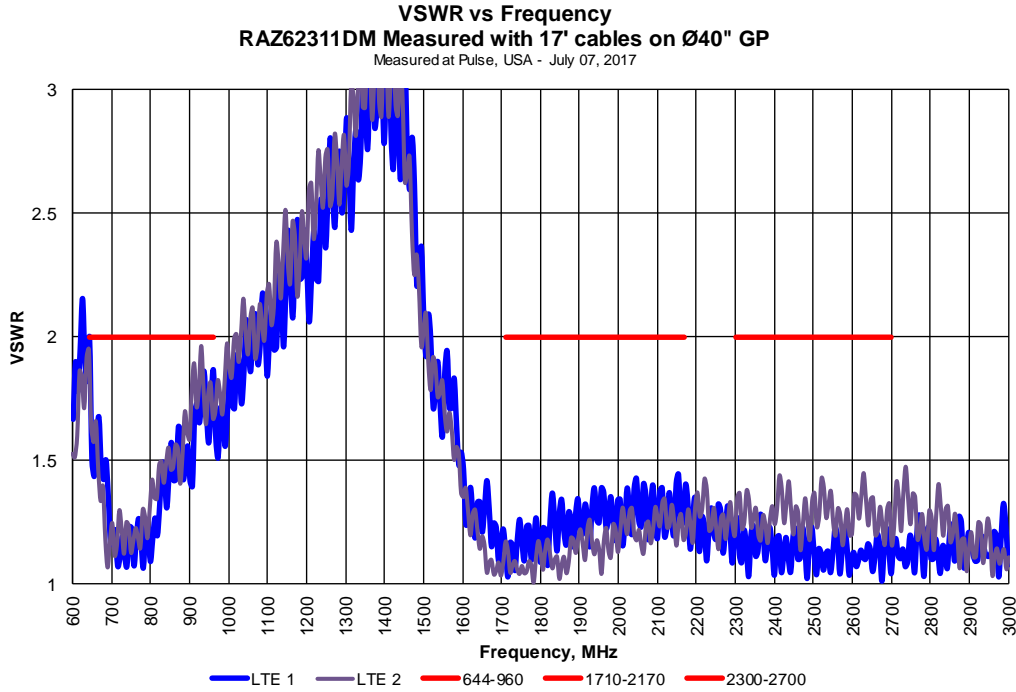

LTE 1 & 2
Measured with 5.2m
(17') cable

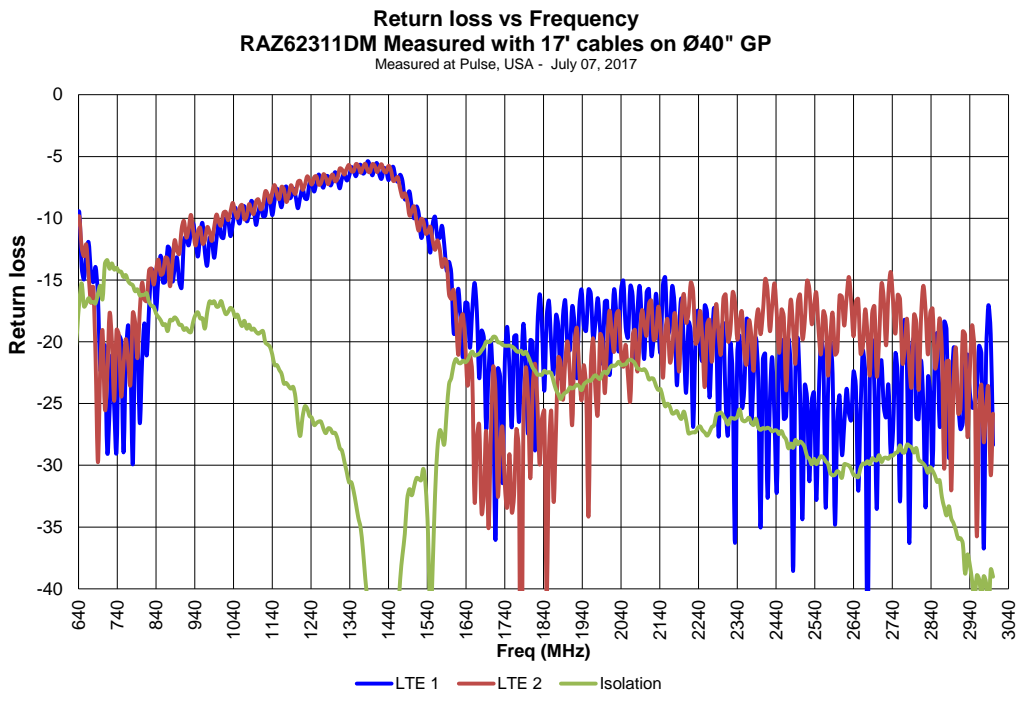

Issue: 1827

In the effort to improve our products, we reserve the right to make changes judged to be necessary.

CONFIDENTIAL AND PROPRIETARY INFORMATION

This document contains confidential and proprietary information of Pulse Electronics, Inc. (Pulse) and is protected by copyright, trade secret and other state and federal laws. Its receipt or possession does not convey any rights to reproduce, disclose its contents, or to manufacture, use or sell anything it may describe. Reproduction, disclosure or use without specific written authorization of Pulse is strictly forbidden.

CHARTS

VSWR vs Frequency
RAZ62311DM Measured with 17' cables on Ø40" GP (WiFi 1, 2 & 3)
Measured at Pulse, USA - July 07, 2017

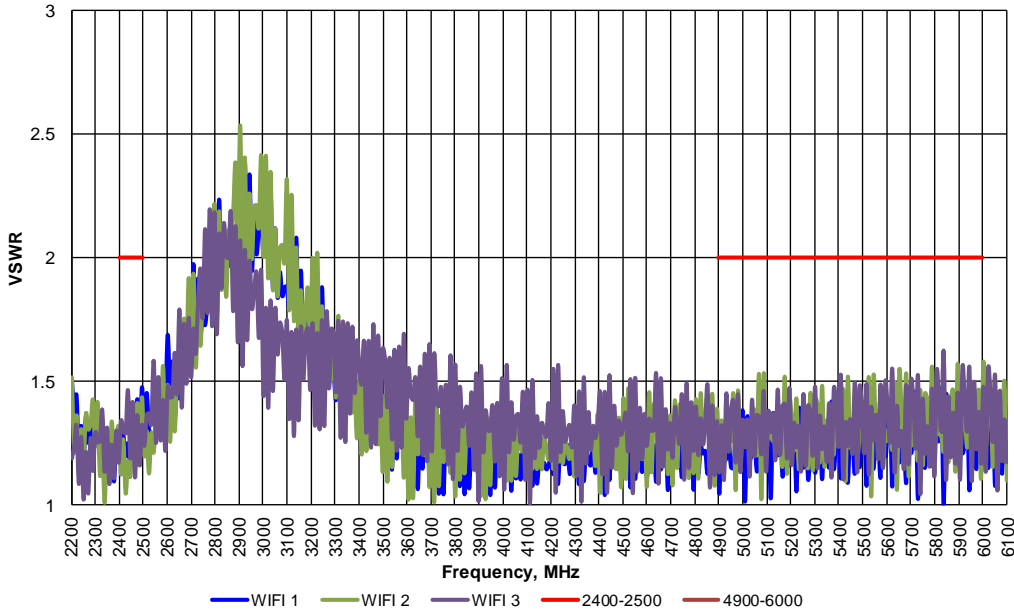

WiFi 1, 2 & 3
Measured with 5.2m
(17') cable

Return loss vs Frequency
RAZ62311DM Measured with 17' cables on Ø40" GP (WiFi 1, 2 & 3)
Measured at Pulse, USA - July 07, 2017

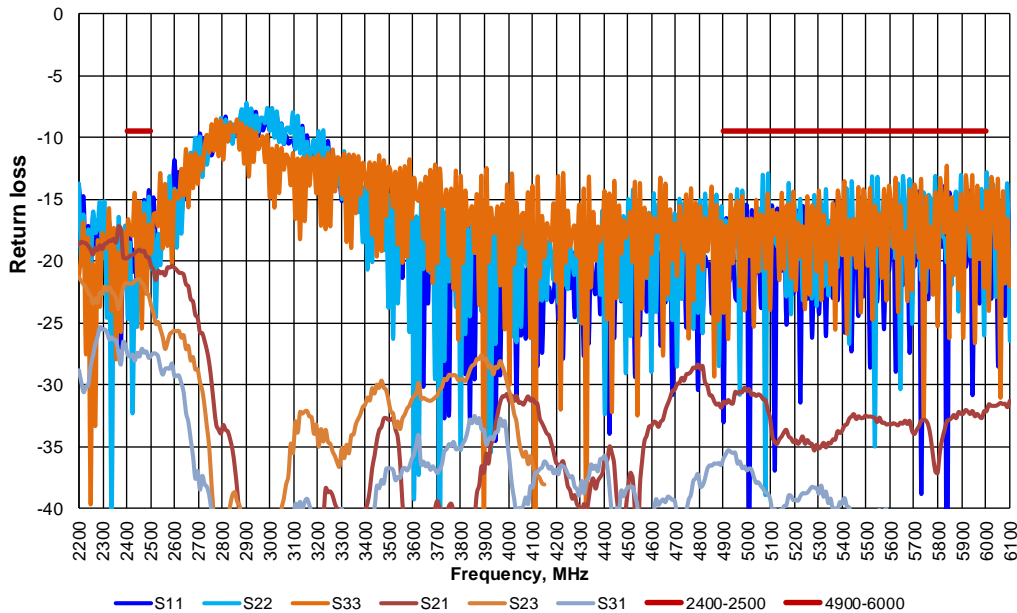

WiFi 1, 2 & 3
Measured with 5.2m
(17') cable

Issue: 1827

In the effort to improve our products, we reserve the right to make changes judged to be necessary.

CONFIDENTIAL AND PROPRIETARY INFORMATION

This document contains confidential and proprietary information of Pulse Electronics, Inc. (Pulse) and is protected by copyright, trade secret and other state and federal laws. Its receipt or possession does not convey any rights to reproduce, disclose its contents, or to manufacture, use or sell anything it may describe. Reproduction, disclosure or use without specific written authorization of Pulse is strictly forbidden.

CHARTS

Peak Gain vs Frequency
RAZ62311DM Measured with 4" cables on Ø40" GP (LTE 1)
Measured at Pulse, USA - Aug 04, 2017

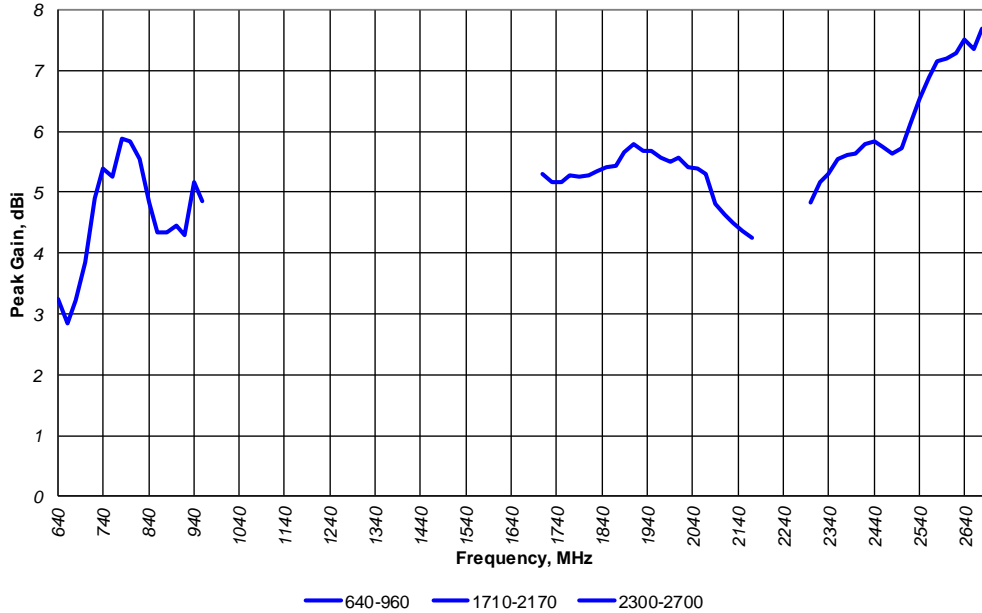

LTE 1
Measured with
102mm (4") cable

Efficiency vs Frequency
RAZ62311DM Measured with 4" cables on Ø40" GP (LTE 1)
Measured at Pulse, USA - aUG 04, 2017

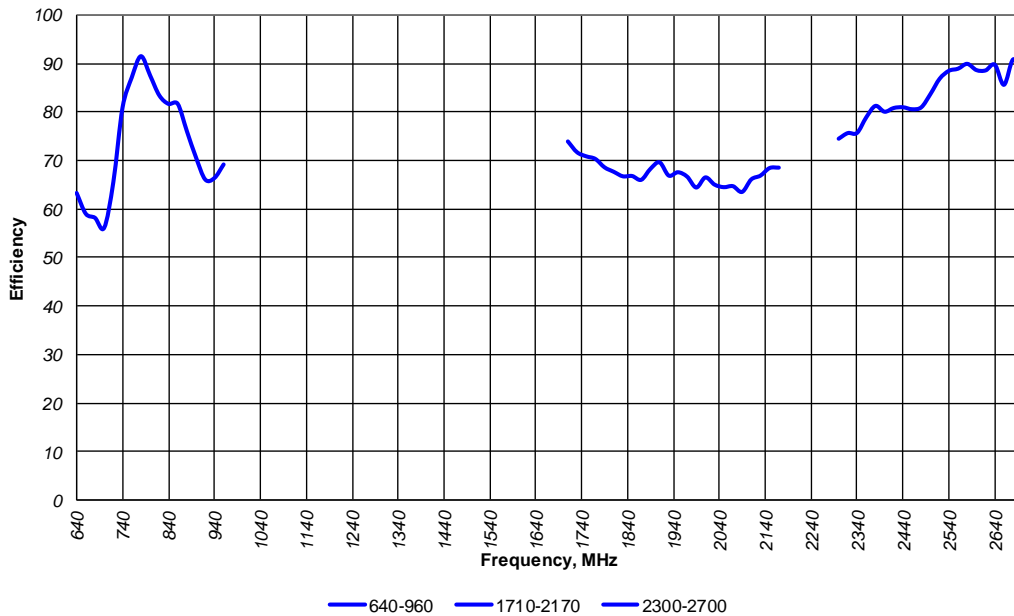

LTE 1
Measured with
102mm (4") cable

Issue: 1827

In the effort to improve our products, we reserve the right to make changes judged to be necessary.

CONFIDENTIAL AND PROPRIETARY INFORMATION

This document contains confidential and proprietary information of Pulse Electronics, Inc. (Pulse) and is protected by copyright, trade secret and other state and federal laws. Its receipt or possession does not convey any rights to reproduce, disclose its contents, or to manufacture, use or sell anything it may describe. Reproduction, disclosure or use without specific written authorization of Pulse is strictly forbidden.

CHARTS

LTE 1
Measured with
102mm (4") cable

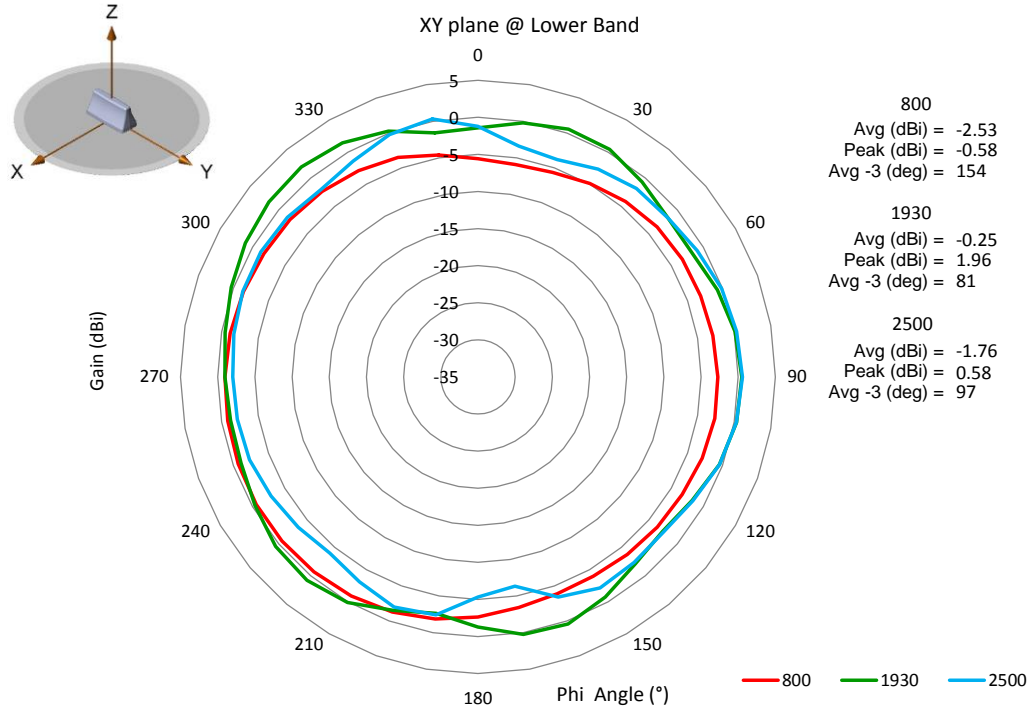

LTE 1
Measured with
102mm (4") cable

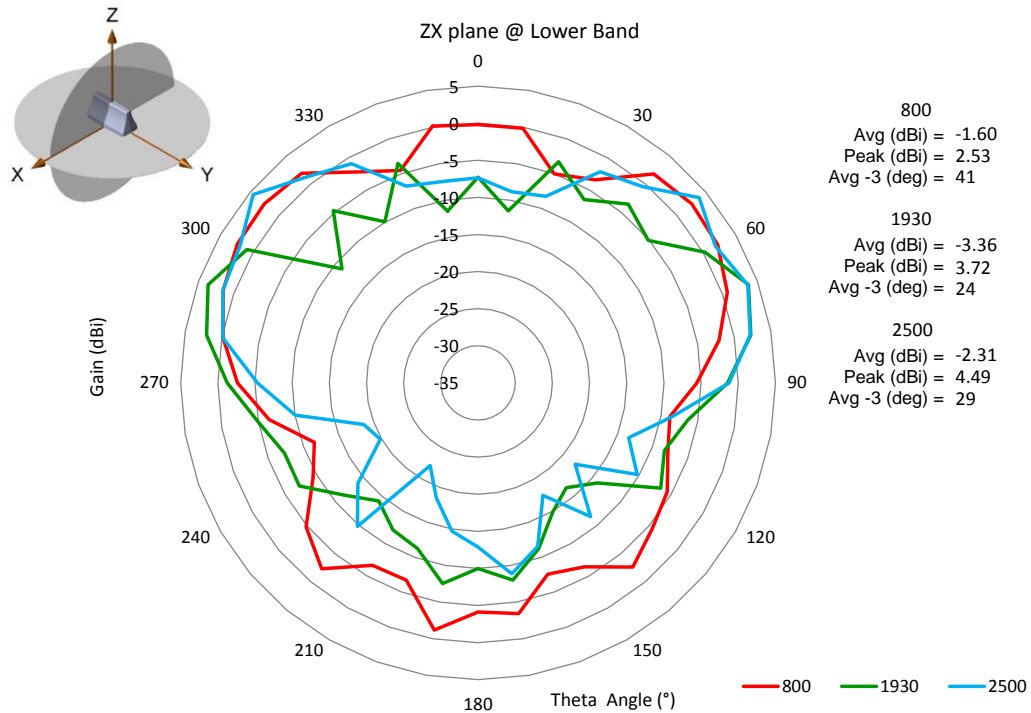

Issue: 1827

In the effort to improve our products, we reserve the right to make changes judged to be necessary.

CONFIDENTIAL AND PROPRIETARY INFORMATION

This document contains confidential and proprietary information of Pulse Electronics, Inc. (Pulse) and is protected by copyright, trade secret and other state and federal laws. Its receipt or possession does not convey any rights to reproduce, disclose its contents, or to manufacture, use or sell anything it may describe. Reproduction, disclosure or use without specific written authorization of Pulse is strictly forbidden.

CHARTS

Peak Gain vs Frequency
RAZ62311DM Measured with 4" cables on Ø40" GP (LTE 2)
Measured at Pulse, USA - Aug 04, 2017

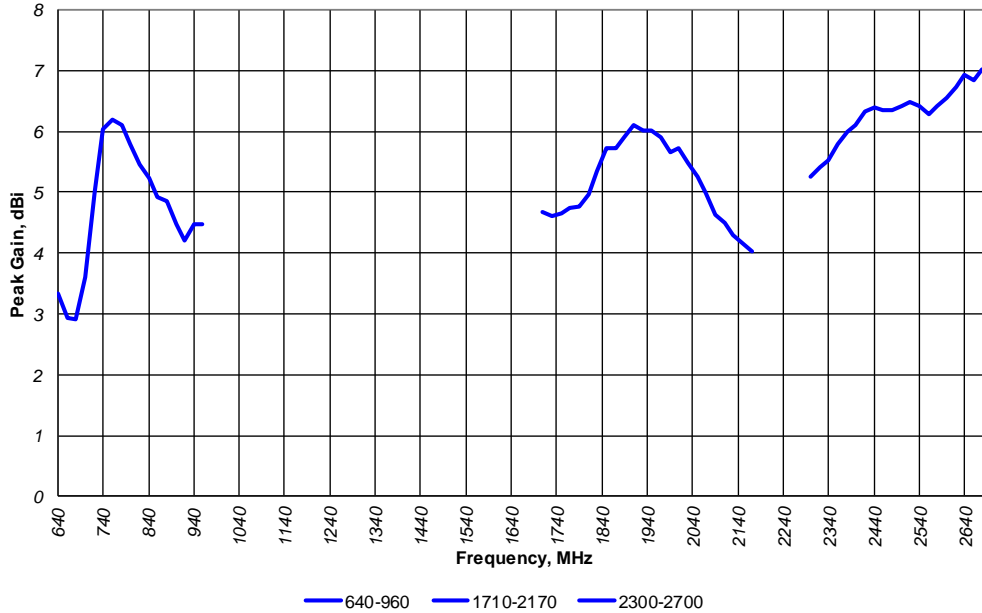

LTE 2
Measured with
102mm (4") cable

Efficiency vs Frequency
RAZ62311DM Measured with 4" cables on Ø40" GP (LTE 2)
Measured at Pulse, USA - AUG 04, 2017

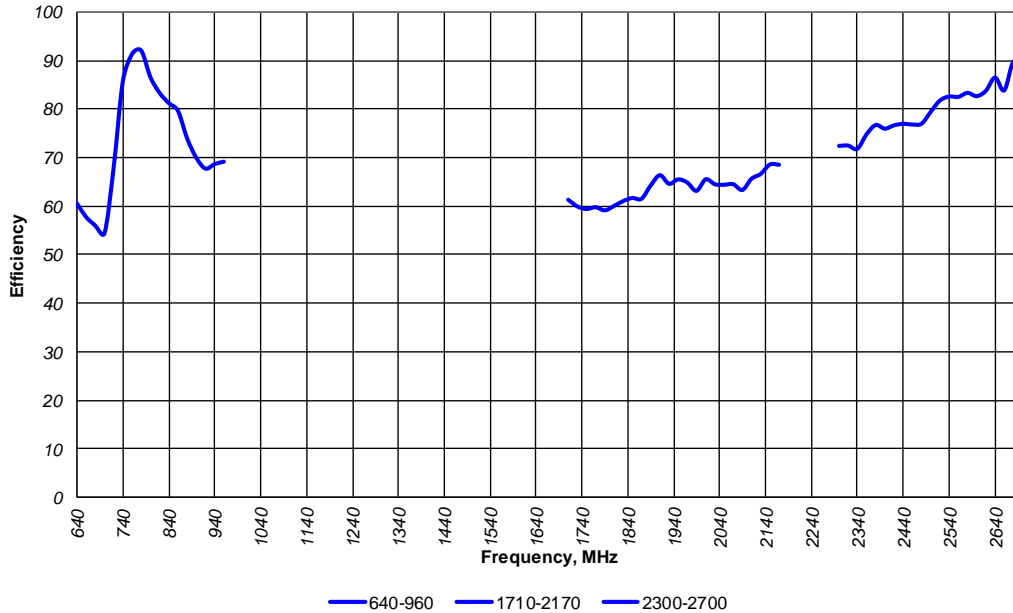

LTE 2
Measured with
102mm (4") cable

Issue: 1827

In the effort to improve our products, we reserve the right to make changes judged to be necessary.

CONFIDENTIAL AND PROPRIETARY INFORMATION

This document contains confidential and proprietary information of Pulse Electronics, Inc. (Pulse) and is protected by copyright, trade secret and other state and federal laws. Its receipt or possession does not convey any rights to reproduce, disclose its contents, or to manufacture, use or sell anything it may describe. Reproduction, disclosure or use without specific written authorization of Pulse is strictly forbidden.

Series: RAZORBACK

PART NUMBER: RAZ32011DM, RAZ32012DM, RAZ42111DM,
RAZ42112DM, RAZ52211DM, RAZ52212DM, RAZ62311DM, RAZ62312DM

CHARTS

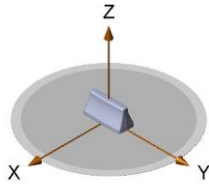

LTE 2
Measured with
102mm (4") cable

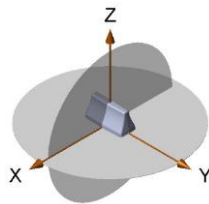
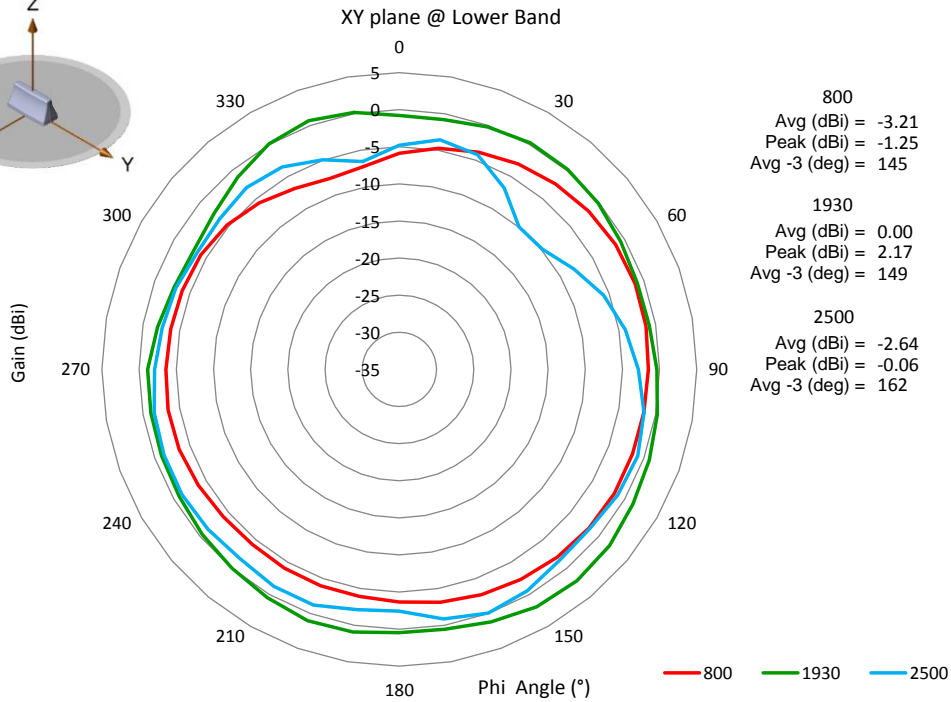

LTE 2
Measured with
102mm (4") cable

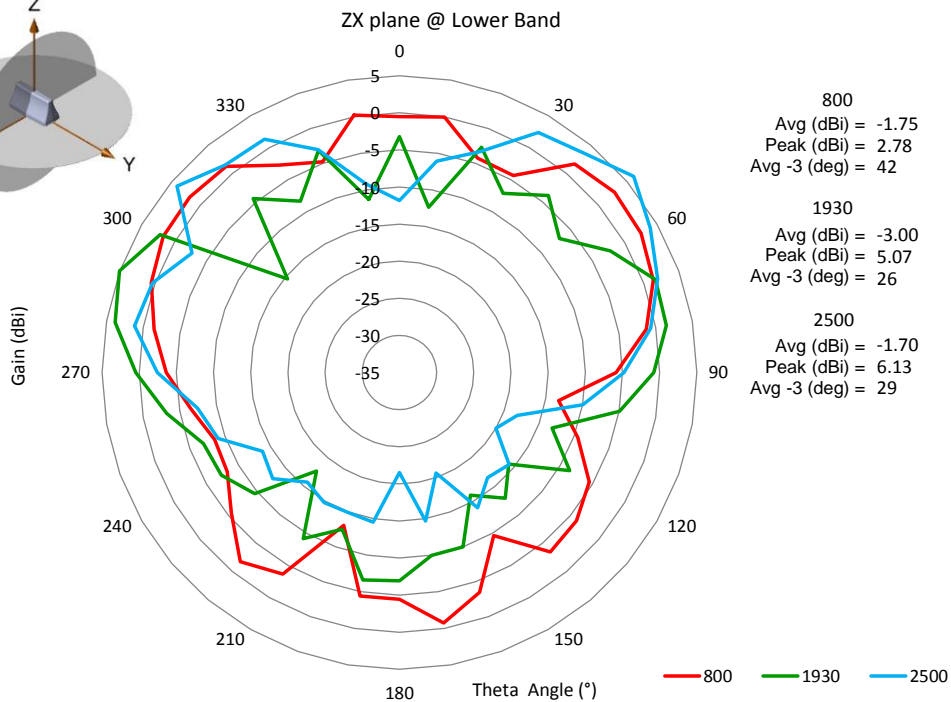

Issue: 1827

In the effort to improve our products, we reserve the right to make changes judged to be necessary.

CONFIDENTIAL AND PROPRIETARY INFORMATION

This document contains confidential and proprietary information of Pulse Electronics, Inc. (Pulse) and is protected by copyright, trade secret and other state and federal laws. Its receipt or possession does not convey any rights to reproduce, disclose its contents, or to manufacture, use or sell anything it may describe. Reproduction, disclosure or use without specific written authorization of Pulse is strictly forbidden.

CHARTS

Peak Gain vs Frequency
RAZ62311DM Measured with 4" cables on Ø40" GP (WiFi 1)
Measured at Pulse, USA - Aug 04, 2017

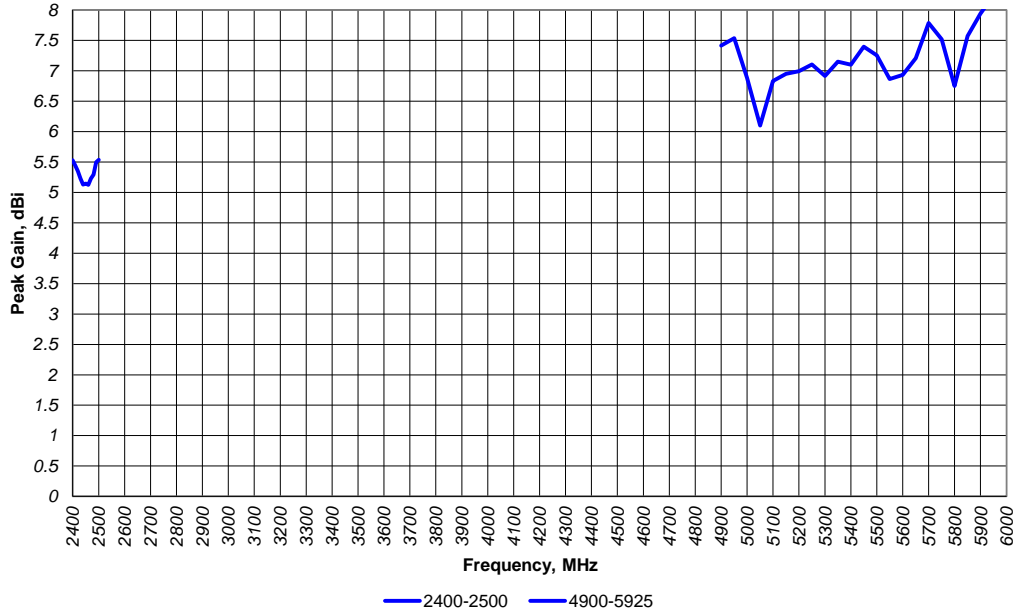

WiFi 1
Measured with
102mm (4") cable

Efficiency vs Frequency
RAZ62311DM Measured with 4" cables on Ø40" GP (WiFi 1)
Measured at Pulse, USA - Aug 04, 2017

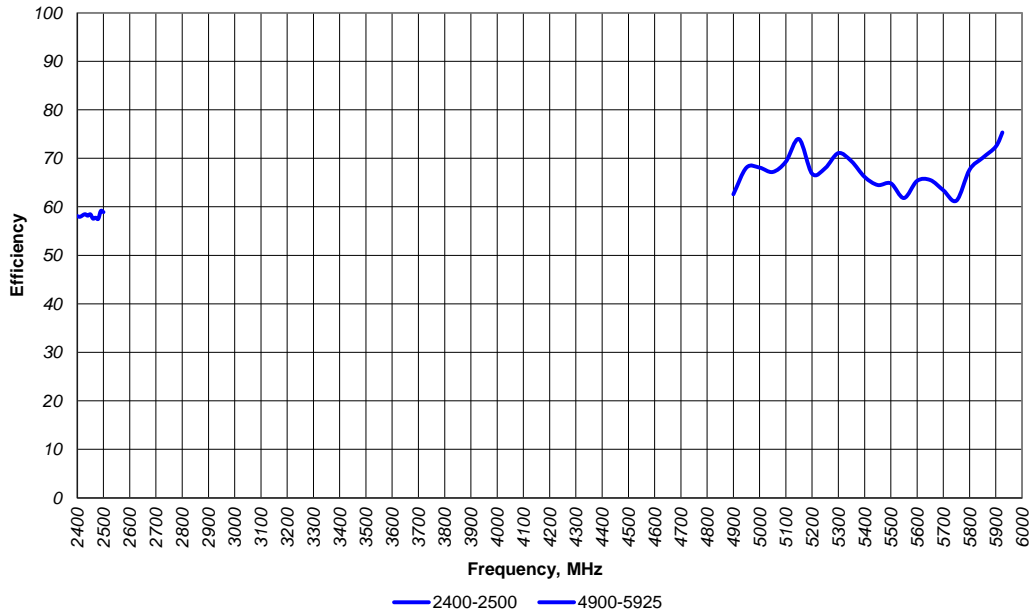

WiFi 1
Measured with
102mm (4") cable

Issue: 1827

In the effort to improve our products, we reserve the right to make changes judged to be necessary.

CONFIDENTIAL AND PROPRIETARY INFORMATION

This document contains confidential and proprietary information of Pulse Electronics, Inc. (Pulse) and is protected by copyright, trade secret and other state and federal laws. Its receipt or possession does not convey any rights to reproduce, disclose its contents, or to manufacture, use or sell anything it may describe. Reproduction, disclosure or use without specific written authorization of Pulse is strictly forbidden.

CHARTS

WiFi 1

Measured with 102mm (4") cable

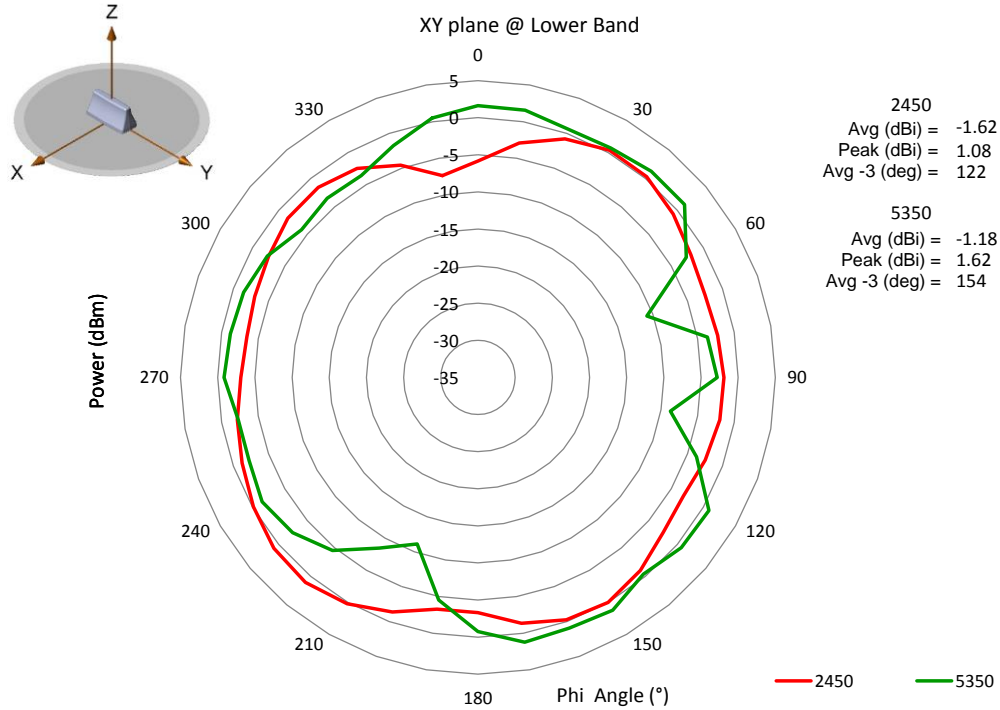

WiFi 1

Measured with 102mm (4") cable

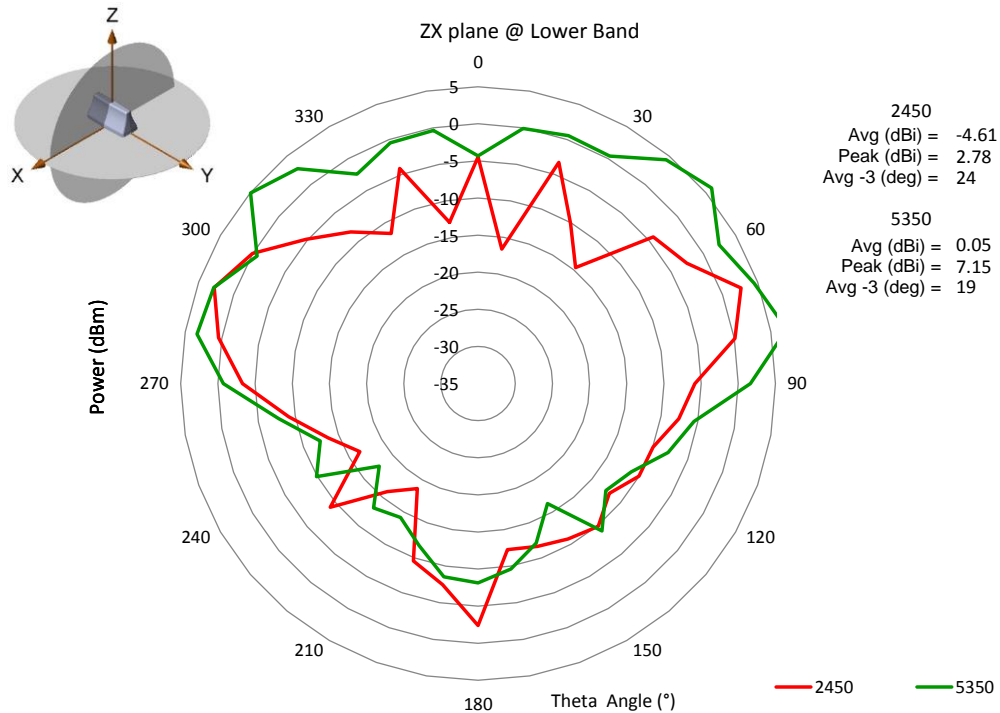

Issue: 1827

In the effort to improve our products, we reserve the right to make changes judged to be necessary.

CONFIDENTIAL AND PROPRIETARY INFORMATION

This document contains confidential and proprietary information of Pulse Electronics, Inc. (Pulse) and is protected by copyright, trade secret and other state and federal laws. Its receipt or possession does not convey any rights to reproduce, disclose its contents, or to manufacture, use or sell anything it may describe. Reproduction, disclosure or use without specific written authorization of Pulse is strictly forbidden.

CHARTS

Peak Gain vs Frequency
RAZ62311DM Measured with 4" cables on Ø40" GP (WiFi 2)
Measured at Pulse, USA - Aug 04, 2017

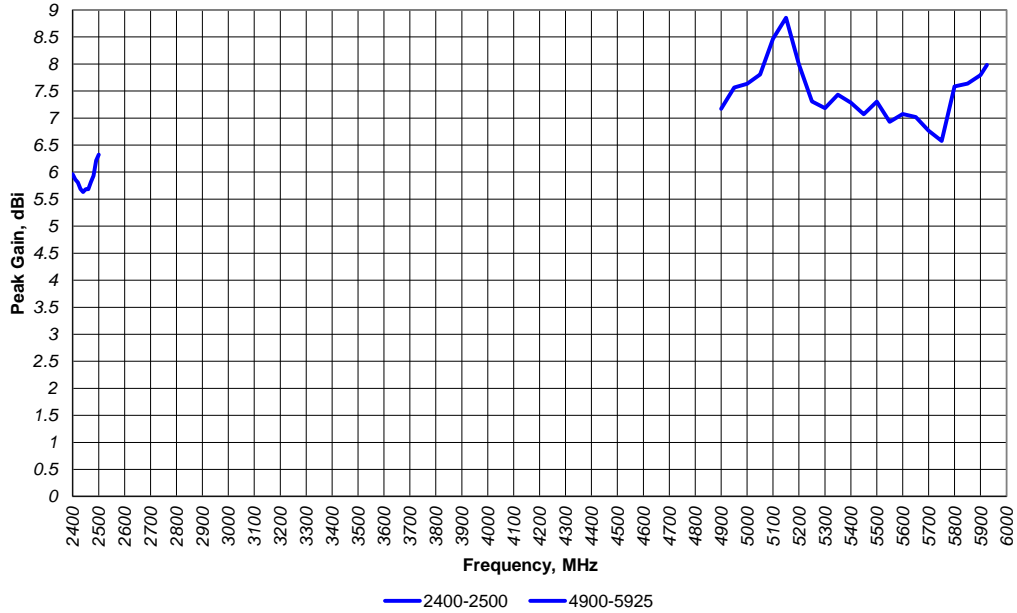

WiFi 2
Measured with
102mm (4") cable

Efficiency vs Frequency
RAZ62311DM Measured with 4" cables on Ø40" GP (WiFi 2)
Measured at Pulse, USA - Aug 04, 2017

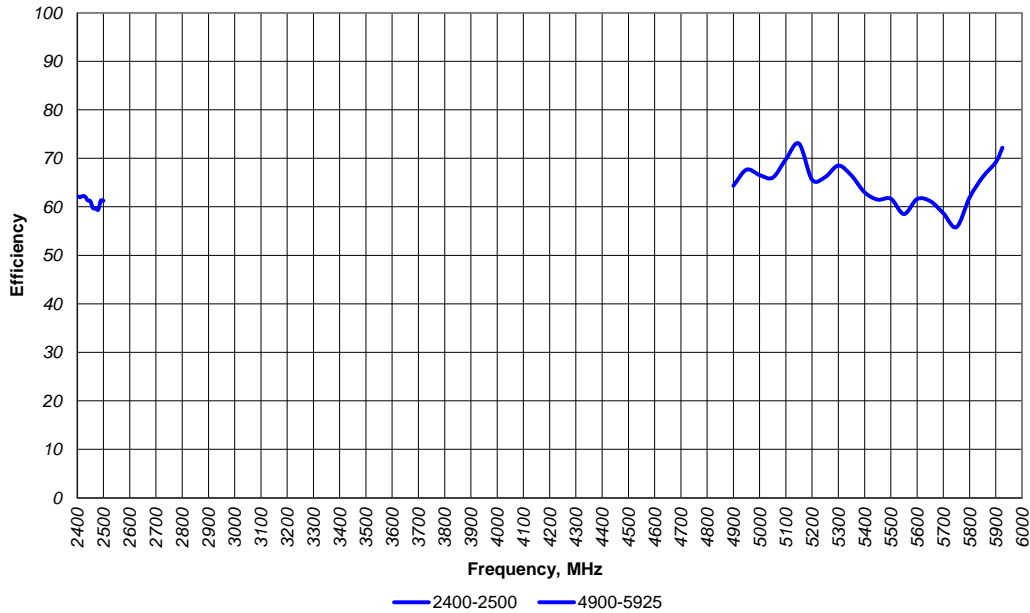

WiFi 2
Measured with
102mm (4") cable

Issue: 1827

In the effort to improve our products, we reserve the right to make changes judged to be necessary.

CONFIDENTIAL AND PROPRIETARY INFORMATION

This document contains confidential and proprietary information of Pulse Electronics, Inc. (Pulse) and is protected by copyright, trade secret and other state and federal laws. Its receipt or possession does not convey any rights to reproduce, disclose its contents, or to manufacture, use or sell anything it may describe. Reproduction, disclosure or use without specific written authorization of Pulse is strictly forbidden.

CHARTS

WiFi 2
Measured with
102mm (4") cable

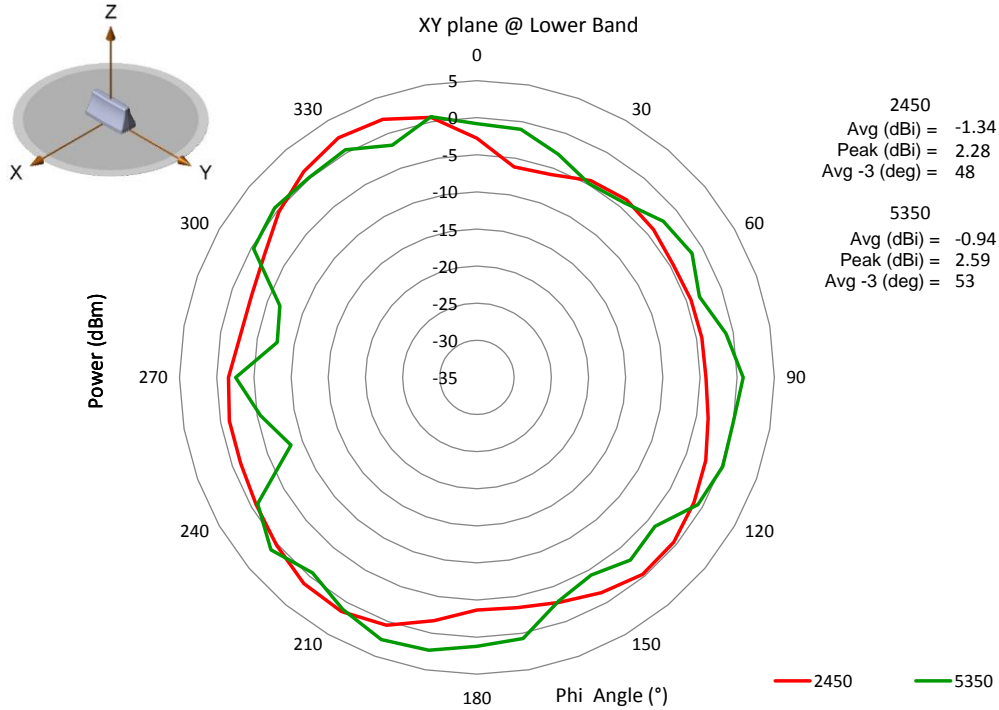

WiFi 2
Measured with
102mm (4") cable

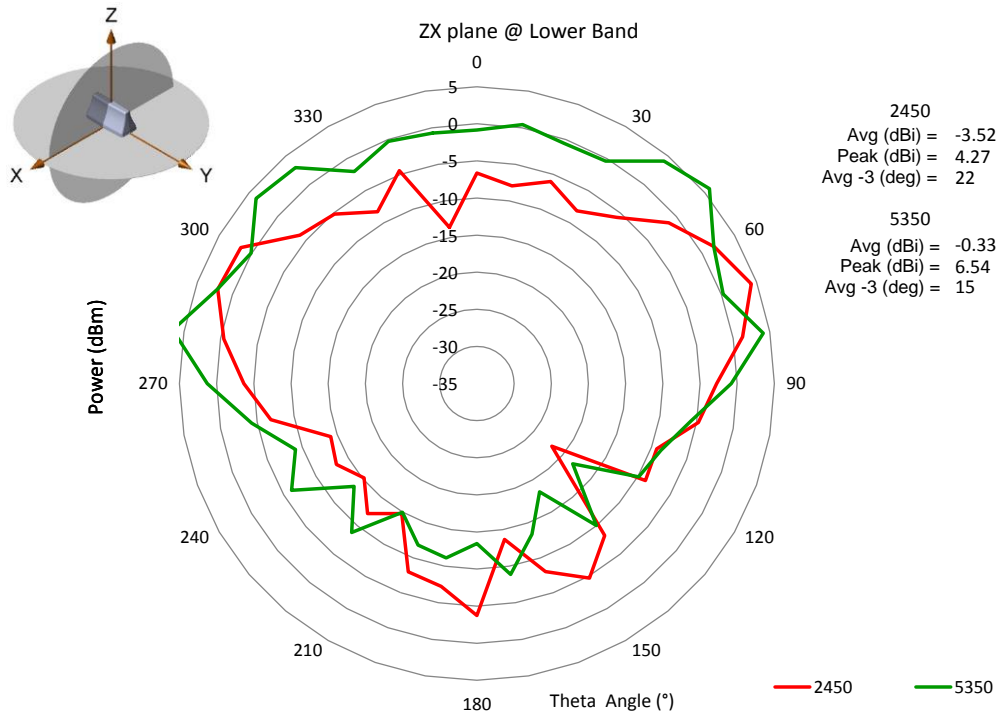

Issue: 1827

In the effort to improve our products, we reserve the right to make changes judged to be necessary.

CONFIDENTIAL AND PROPRIETARY INFORMATION

This document contains confidential and proprietary information of Pulse Electronics, Inc. (Pulse) and is protected by copyright, trade secret and other state and federal laws. Its receipt or possession does not convey any rights to reproduce, disclose its contents, or to manufacture, use or sell anything it may describe. Reproduction, disclosure or use without specific written authorization of Pulse is strictly forbidden.

Series: RAZORBACK

PART NUMBER: RAZ32011DM, RAZ32012DM, RAZ42111DM,
RAZ42112DM, RAZ52211DM, RAZ52212DM, RAZ62311DM, RAZ62312DM

CHARTS

Peak Gain vs Frequency
RAZ62311DM Measured with 4" cables on Ø40" GP (WiFi 3)
Measured at Pulse, USA - Aug 04, 2017

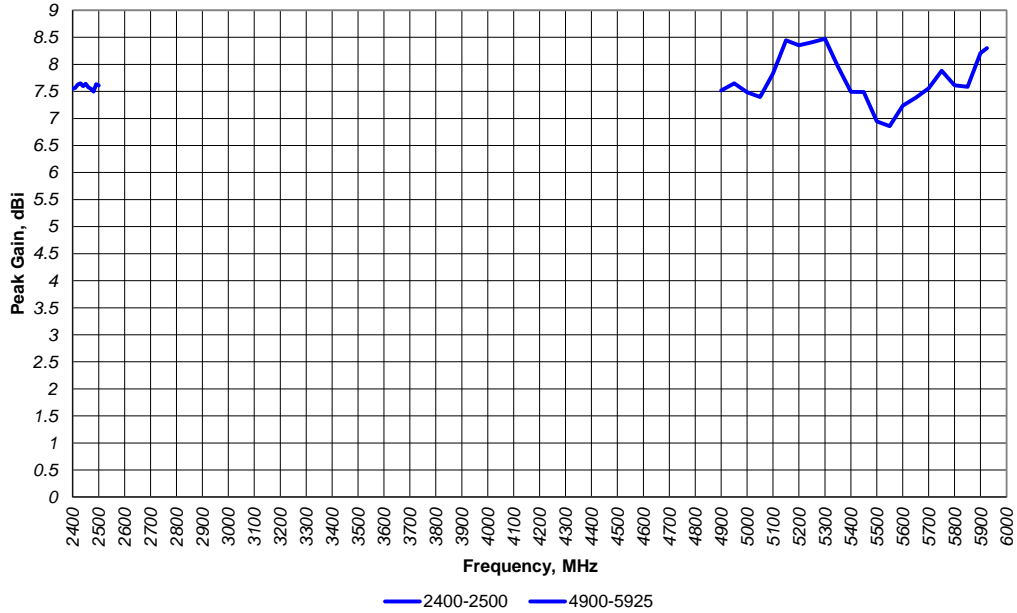

WiFi 3
Measured with
102mm (4") cable

Efficiency vs Frequency
RAZ62311DM Measured with 4" cables on Ø40" GP (WiFi 3)
Measured at Pulse, USA - Aug 04, 2017

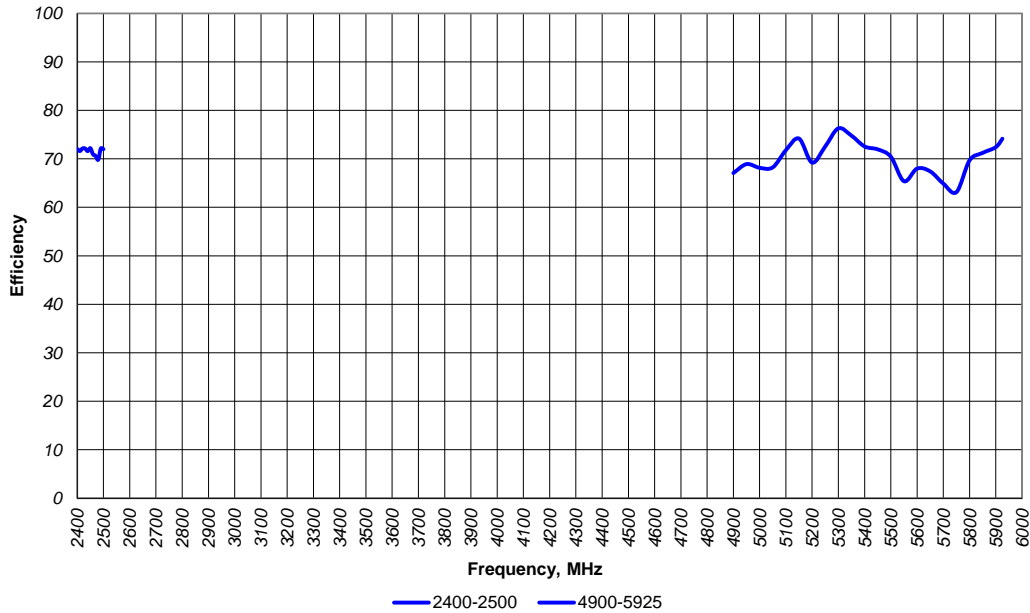

WiFi 3
Measured with
102mm (4") cable

Issue: 1827

In the effort to improve our products, we reserve the right to make changes judged to be necessary.

CONFIDENTIAL AND PROPRIETARY INFORMATION

This document contains confidential and proprietary information of Pulse Electronics, Inc. (Pulse) and is protected by copyright, trade secret and other state and federal laws. Its receipt or possession does not convey any rights to reproduce, disclose its contents, or to manufacture, use or sell anything it may describe. Reproduction, disclosure or use without specific written authorization of Pulse is strictly forbidden.

Series: RAZORBACK

PART NUMBER: RAZ32011DM, RAZ32012DM, RAZ42111DM,
RAZ42112DM, RAZ52211DM, RAZ52212DM, RAZ62311DM, RAZ62312DM

CHARTS

WiFi 3
Measured with
102mm (4") cable

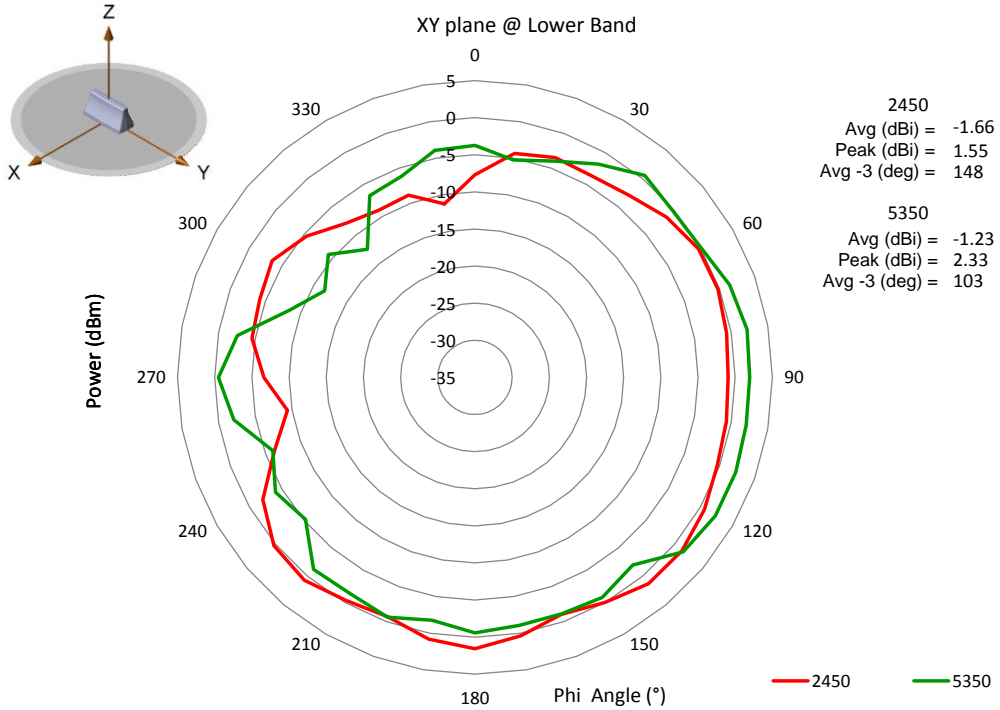

WiFi 3
Measured with
102mm (4") cable

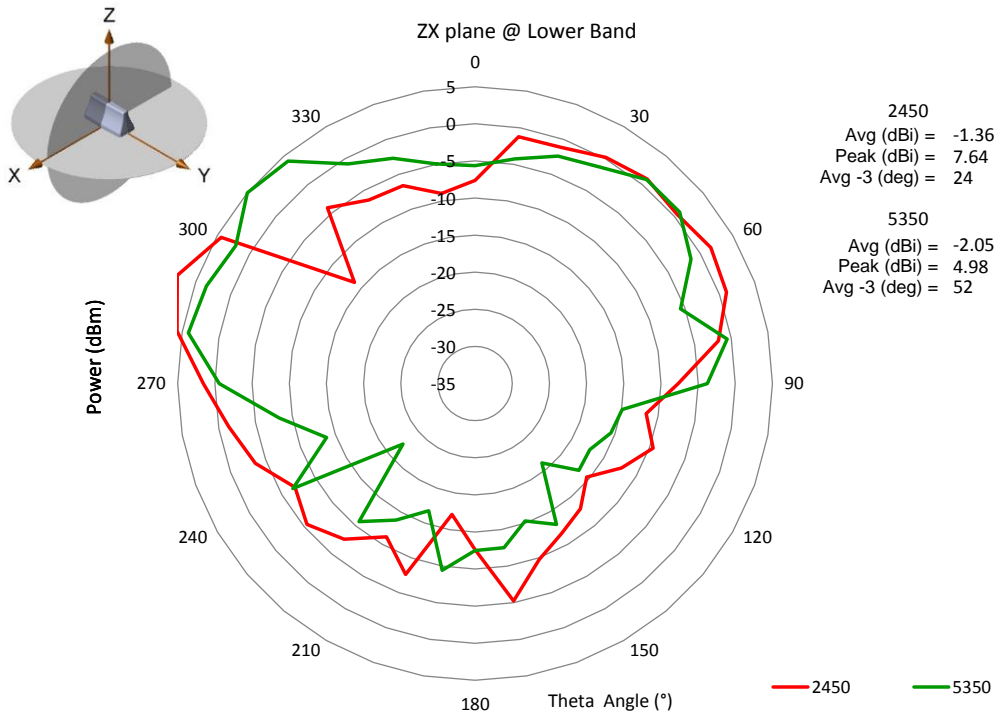

Issue: 1827

In the effort to improve our products, we reserve the right to make changes judged to be necessary.

CONFIDENTIAL AND PROPRIETARY INFORMATION

This document contains confidential and proprietary information of Pulse Electronics, Inc. (Pulse) and is protected by copyright, trade secret and other state and federal laws. Its receipt or possession does not convey any rights to reproduce, disclose its contents, or to manufacture, use or sell anything it may describe. Reproduction, disclosure or use without specific written authorization of Pulse is strictly forbidden.

CHARTS

GNSS LNA Gain and out-of-band rejection

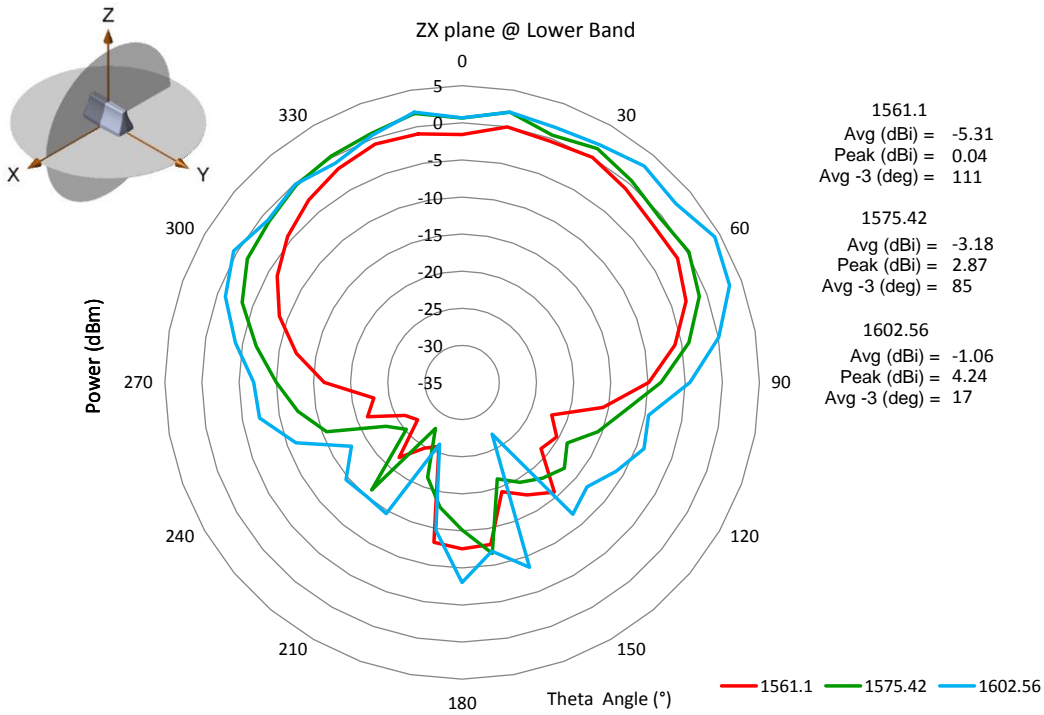
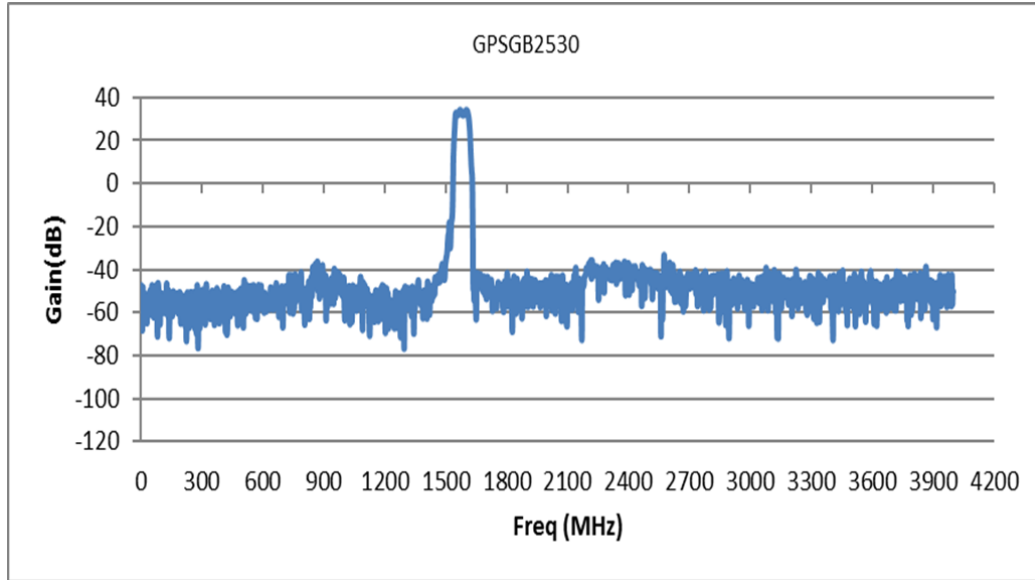

GNSS

Passive
Measurement
Measured with
152mm (6") cable

Issue: 1827

In the effort to improve our products, we reserve the right to make changes judged to be necessary.

CONFIDENTIAL AND PROPRIETARY INFORMATION

This document contains confidential and proprietary information of Pulse Electronics, Inc. (Pulse) and is protected by copyright, trade secret and other state and federal laws. Its receipt or possession does not convey any rights to reproduce, disclose its contents, or to manufacture, use or sell anything it may describe. Reproduction, disclosure or use without specific written authorization of Pulse is strictly forbidden.

Description: GNSS/2x LTE/0, 1x, 2x or 3x WiFi
Direct Mount

Series: RAZORBACK

PART NUMBER: RAZ32011DM, RAZ32012DM, RAZ42111DM,
RAZ42112DM, RAZ52211DM, RAZ52212DM, RAZ62311DM, RAZ62312DM

PACKAGING

1pcs antennas per foam bag

6pcs antennas per package box

Total 6pcs antenna per package box

Package box: 558mm*386mm*210mm

单击下面可查看定价，库存，交付和生命周期等信息

[>>Pulse\(普思\)](#)