

NOTES:

1. ROHS COMPLIANT
2. HEADER: DAP (DIALLYL PHTHALATE) WITH FLAMMABILITY RATING UL 94V-0 OR BETTER.
3. STORAGE TEMPERATURE: -20°C TO +125°C
4. COMPLIANCE TO J-STD:
 - A. J-STD-002: SOLDERABILITY AT 245°C REFLOW PROFILE
 - B. J-STD-020: LEVEL 1, NO MOISTURE SENSITIVE
 - C. J-STD-075: R7, 245°C MAXIMUM THROUGH REFLOW SOLDER
5. TO ORDER TAPE & REEL PACKAGING ADD A "T" SUFFIX TO THE PART NUMBER(i.e H1270NL BECOMES H1270NLT).

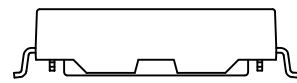
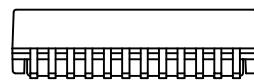

FINAL OUTLINE

© Copyright, 2017. Pulse Electronics Corp. All rights reserved. Pulse confidential & proprietary. (05/12/17)

| PRODUCT DESCRIPTION | TLA DRAWING | PS DRAWING | SHEET | PART NO. | DATASHEET REV. |
|-------------------------|-------------|---------------|--------|----------|----------------|
| MDL,DUAL,100D,1:1,SM,TU | H1270NL-12 | PS-0047.001-B | 1 OF 3 | H1270NL | B |

ELECTRICAL CHARACTERISTICS AT +25°C UNLESS OTHER SPECIFIED
MEETS IEEE 802.3 SPECIFICATION

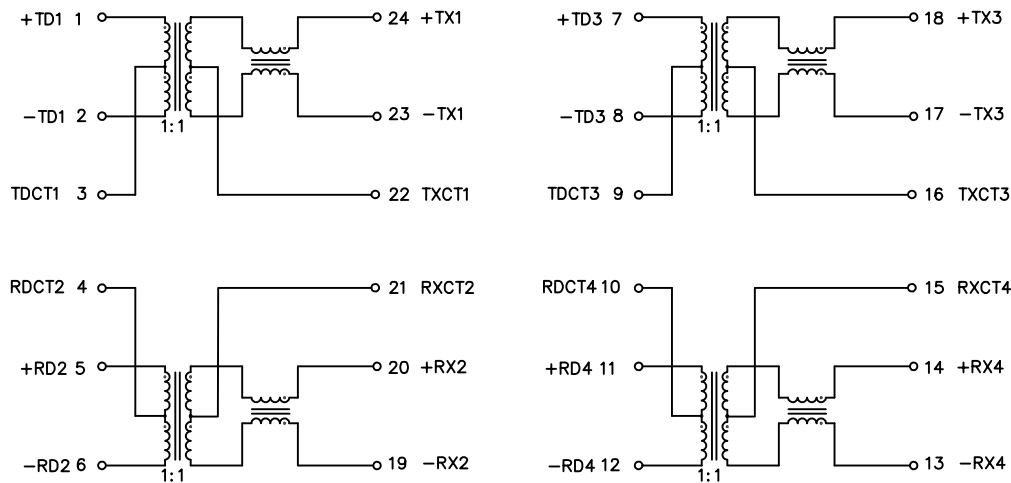

SCHEMATIC

| PARAMETER | SPECIFICATIONS | |
|--|---|--|
| OPERATING TEMP | 0°C TO +70°C | |
| URNS RATIO | 1 : 1 ±2% | |
| POLARITY | PER SCHEMATIC | |
| INSERTION LOSS | 100 KHz | 1–125 MHz |
| | -1.2 dB MAX | -0.2–0.002*f ^{1.4} dB MAX |
| RETURN LOSS, 100BT (Z OUT = 100 OHM ±15%) | .1–30 MHz | 30–60 MHz |
| | -16 dB MIN | -10+20*LOG ₁₀ (f/60 MHz) dB MIN |
| INDUCTANCE (OCL) (MEDIA SIDE, 0°C~+70°C) | 350 uH MIN (MEASURED AT 100 KHz, 100 mVRMS AND WITH 8 mA DC BIAS) | |
| | 1 MHz | 10–100 MHz |
| CROSSTALK, ADJACENT CHANNELS | -50 dB MIN | -55+22*LOG ₁₀ (f/10) dB MIN |
| | 2 MHz | 30–200 MHz |
| COMMON MODE REJECTION RATIO | -50 dB MIN | -15+20*LOG ₁₀ (f/200) dB MIN |
| | .65 OHMS MAX | |
| DC RESISTANCE, 1/2 WINDING | .65 OHMS MAX | |
| DC RESISTANCE IMBALANCE | ±.065 OHMS MAX (CENTER TAP SYMMETRY) | |
| INPUT – OUTPUT ISOLATION | 1500 VRMS MIN @ 60 SECONDS | |

NOTE: f IS FREQUENCY IN MHZ.

© Copyright, 2017. Pulse Electronics Corp. All rights reserved. Pulse confidential & proprietary. (05/12/17)

| PRODUCT DESCRIPTION | TLA DRAWING | PS DRAWING | SHEET | PART NO. | DATASHEET REV. |
|-------------------------|-------------|---------------|--------|----------|----------------|
| MDL,DUAL,100D,1:1,SM,TU | H1270NL-12 | PS-0047.001-B | 2 OF 3 | H1270NL | B |

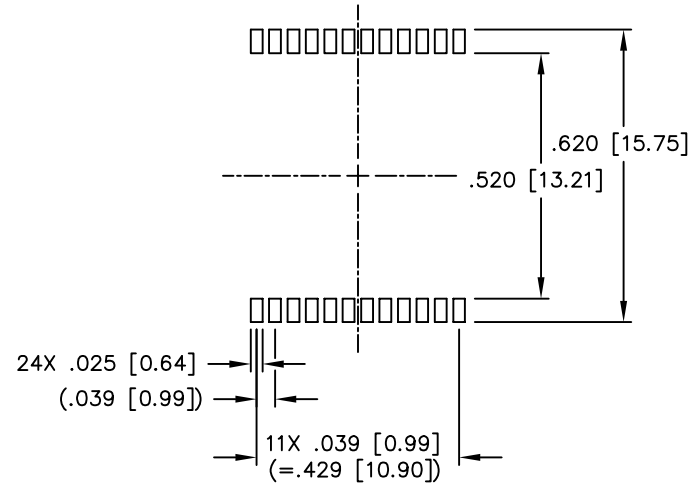
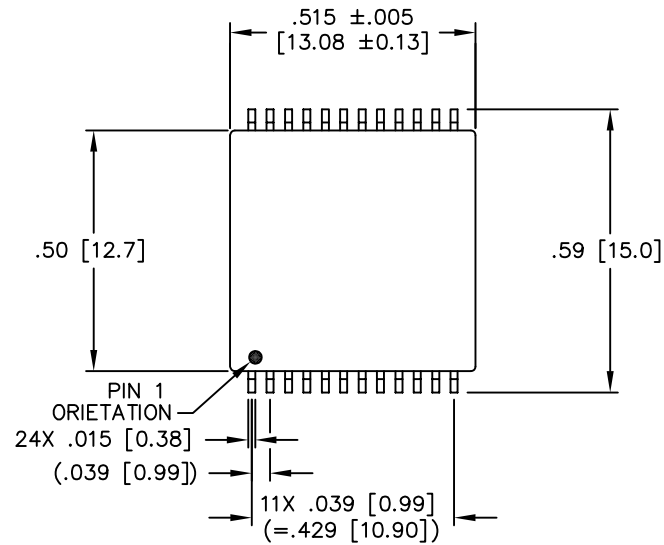

SUGGESTED LAND PATTERN

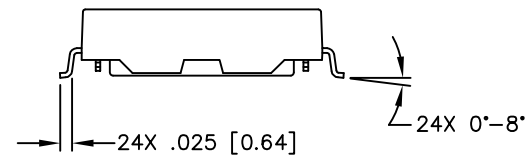
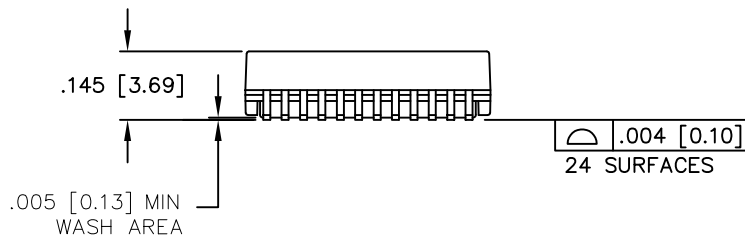

DIMENSIONS ARE IN INCHES [MILLIMETERS] WITH THE FOLLOWING TOLERANCES: [MILLIMETERS] ARE FOR REFERENCE ONLY.
 .XX= ±.01 [±0.25]
 .XXX= ±.005 [±0.13]

© Copyright, 2017. Pulse Electronics Corp. All rights reserved. Pulse confidential & proprietary. (05/12/17)

| PRODUCT DESCRIPTION | TLA DRAWING | PS DRAWING | SHEET | PART NO. | DATASHEET REV. |
|-------------------------|-------------|---------------|--------|----------|----------------|
| MDL,DUAL,100D,1:1,SM,TU | H1270NL-12 | PS-0047.001-B | 3 OF 3 | H1270NL | B |

单击下面可查看定价，库存，交付和生命周期等信息

[>>Pulse\(普思\)](#)