

NOTES:

1. ROHS COMPLIANT
2. HEADER: DAP (DIALLYL PHTHALATE) WITH FLAMMABILITY RATING UL 94V-0 OR BETTER.
3. STORAGE TEMPERATURE: -50°C TO +125°C
4. COMPLIANCE TO J-STD:
  - A. J-STD-002: SOLDERABILITY AT 245°C REFLOW PROFILE
  - B. J-STD-020: LEVEL 1, NO MOISTURE SENSITIVE
  - C. J-STD-075: R7, 245°C MAXIMUM THROUGH REFLOW SOLDER
5. TO ORDER TAPE & REEL PACKAGING ADD A "T" SUFFIX TO THE PART NUMBER(i.e HX1198FNL BECOMES HX1198FNLT).

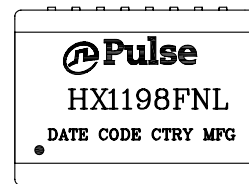

FINAL OUTLINE

© Copyright, 2014. Pulse Electronics Corp. All rights reserved. Pulse confidential & proprietary. (06/12/14)

PRODUCT DESCRIPTION	TLA DRAWING	PS DRAWING	SHEET	PART NO.	DATASHEET REV.
MDL,SIN,100D,1:1,SM,TU	HX1198FNL-13	PS-2005.002-D	1 OF 3	HX1198FNL	A

ELECTRICAL CHARACTERISTICS AT +25°C UNLESS OTHER SPECIFIED  
MEETS IEEE 802.3 SPECIFICATION

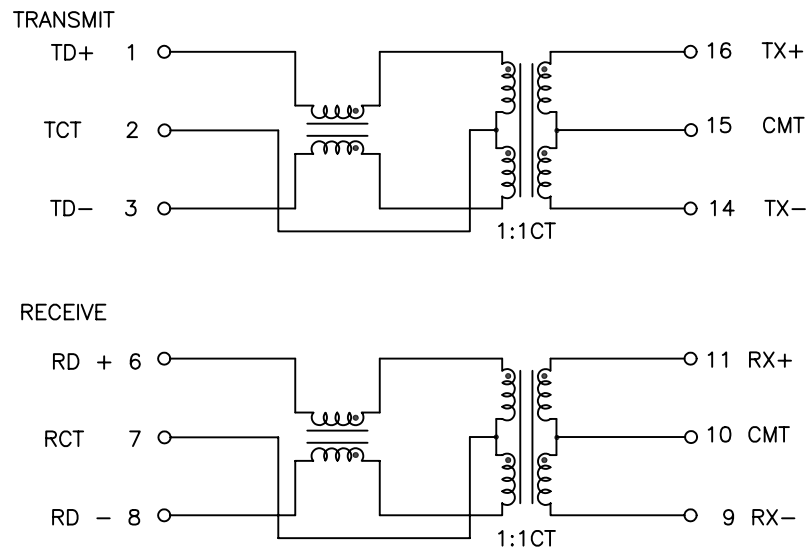

SCHEMATIC

NO CONNECT: PINS 4, 5, 12, AND 13.

PARAMETER	SPECIFICATIONS	
OPERATING TEMPERATURE	-40°C ~ +85°C	
TURNS RATIO	1 : 1 ± 2%	
POLARITY	PER SCHEMATIC	
INSERTION LOSS	100 KHz	1-125 MHz
	-1.2 dB MAX	-0.2-0.002*f <sup>1.4</sup> dB MAX
RETURN LOSS (Z OUT = 100 OHM±15%)	5MHz	30-80MHz
	-18 dB MIN	-16 + 26LOG <sub>10</sub> (f/30MHz) dB MIN
INDUCTANCE (OCL) (MEDIA SIDE, -40°C ~ +85°C)	350 uH MIN (MEASURED AT 100 KHz, 100 mVRMS AND WITH 8 mA DC BIAS)	
CROSSTALK (TX-RX)	1 MHz	5-100MHz
	-62 dB MIN	-45 + 21LOG <sub>10</sub> (f/30MHz) dB MIN
DIFFERENTIAL TO COMMON MODE REJECTION	5-200MHz	
	-50+17LOG <sub>10</sub> (f/5MHz) dB MIN	
ISOLATION (INPUT - OUTPUT)	1500 VRMS MIN @ 60 SECONDS	

NOTE: f IS FREQUENCY IN MHZ.

LEGEND

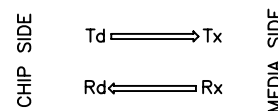

ALL CHANNELS IN  
PHASE INPUT TO  
OUTPUT

© Copyright, 2014. Pulse Electronics Corp. All rights reserved. Pulse confidential & proprietary. (06/12/14)

PRODUCT DESCRIPTION	TLA DRAWING	PS DRAWING	SHEET	PART NO.	DATASHEET REV.
MDL,SIN,100D,1:1,SM,TU	HX1198FNL-13	PS-2005.002-D	2 OF 3	HX1198FNL	A

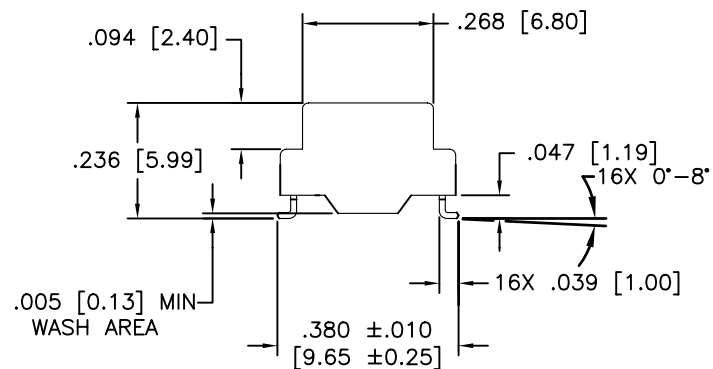
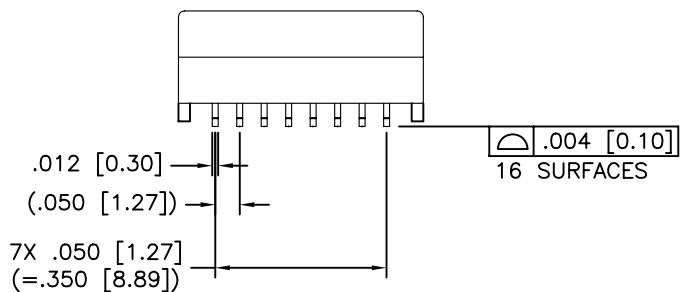
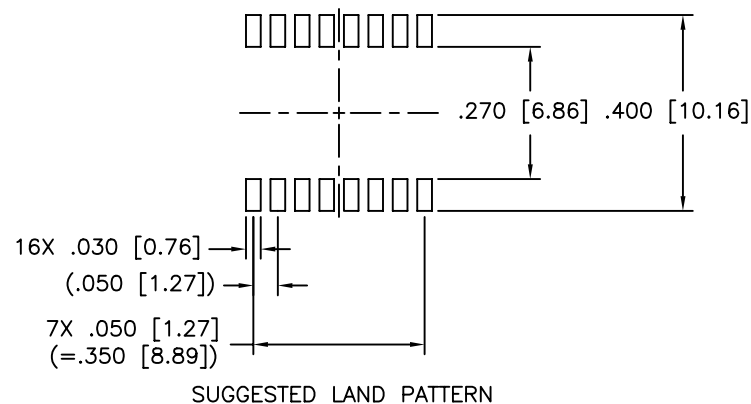
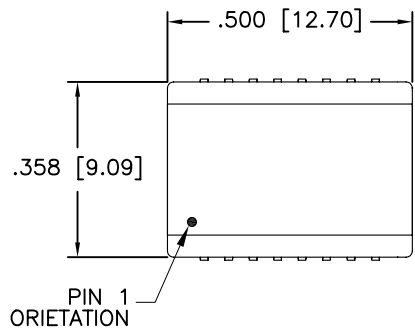

DIMENSIONS ARE IN INCHES [MILLIMETERS] WITH THE FOLLOWING TOLERANCES: [MILLIMETERS] ARE FOR REFERENCE ONLY.  
 .XX= ±.01 [±0.25]  
 .XXX= ±.005 [±0.13]

© Copyright, 2014. Pulse Electronics Corp. All rights reserved. Pulse confidential & proprietary. (06/12/14)

PRODUCT DESCRIPTION	TLA DRAWING	PS DRAWING	SHEET	PART NO.	DATASHEET REV.
MDL,SIN,100D,1:1,SM,TU	HX1198FNL-13	PS-2005.002-D	3 OF 3	HX1198FNL	A

单击下面可查看定价，库存，交付和生命周期等信息

[>>Pulse\(普思\)](#)