

Description: 2.4GHz Ceramic Chip Antenna

Series: Ceramic Chip Antenna

PART NUMBER: W3008G



Features:

- Frequency 2400-2483.5MHz
- Size 3.2 x 1.6 x 1.1mm
- Efficiency >80%
- Gain >1.5dBi
- SMD compatible
- MSL 1

Applications:

- 2.4GHz ISM band radios
- Bluetooth, BLE
- WiFi 2.4GHz
- IoT, M2M devices

All dimensions are in mm / inches

Issue: 1946

In the effort to improve our products, we reserve the right to make changes judged to be necessary.

CONFIDENTIAL AND PROPRIETARY INFORMATION

This document contains confidential and proprietary information of Pulse Electronics, Inc. (Pulse) and is protected by copyright, trade secret and other state and federal laws. Its receipt or possession does not convey any rights to reproduce, disclose its contents, or to manufacture, use or sell anything it may describe. Reproduction, disclosure or use without specific written authorization of Pulse is strictly forbidden.

For more information:

Pulse Worldwide Headquarters
15255 Innovation Drive #100
San Diego, CA 92128
USA
Tel: 1-858-674-8100

Pulse/Larsen Antennas
18110 SE 34th St Bldg 2 Suite 250
Vancouver, WA 98683
USA
Tel: 1-360-944-7551

Europe Headquarters
Pulse GmbH & Do, KG
Zeppelinstrasse 15
Herrenberg, Germany

Pulse (Suzhou) Wireless Products Co, Inc.
99 Huo Ju Road(#29 Bldg,4th Phase
Suzhou New District
Jiangsu Province, Suzhou 215009 PR China
Tel: 86 512 6807 9998

Description: 2.4GHz Ceramic Chip Antenna

Series: Ceramic Chip Antenna

PART NUMBER: W3008G

ELECTRICAL SPECIFICATIONS

Antenna Type	Ceramic Chip
Frequency	2400-2483.5MHz
Nominal Impedance	50 Ω
VSWR	<1.6:1
Radiation Pattern	Omni
Gain	>1.5dBi
Efficiency	>80%
Polarization	Linear
Power Withstanding	2W

MECHANICAL SPECIFICATIONS

Weight	0.03 g
Overall Length	3.2 [0.126] MM [INCHES]
Over all width	1.6 [0.063] MM [INCHES]
Over all thickness	1.1 [0.043] MM [INCHES]
MSL (Moisture Sensitivity Level)	1

ENVIRONMENTAL SPECIFICATIONS

Operating Temperature	-40 / +85 ° C
Storage Temperature	-40 / +85 ° C
RoHS Compliant	Yes

Description: 2.4GHz Ceramic Chip Antenna

Series: Ceramic Chip Antenna

PART NUMBER: W3008G

MECHANICAL DRAWING

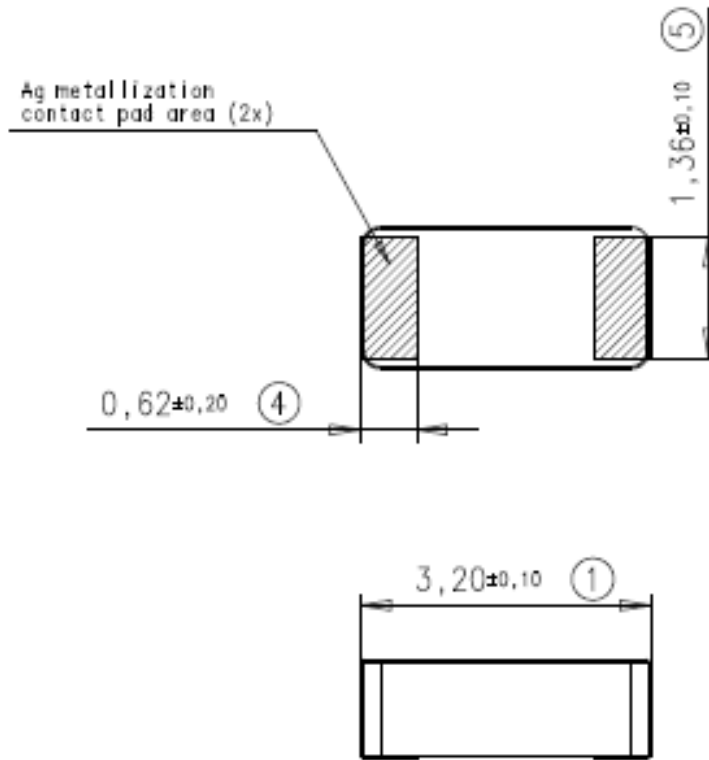

Antenna features		
No.	Terminal Name	Terminal Dimensions
1	Feed / GND	0.62 x 1.36 mm
2	Feed / GND	0.62 x 1.36 mm

Antenna is symmetrical. Either of terminals 1 or 2 can be Feed / GND

Note: This type of antenna is called loaded PIFA. One pad (on the bottom of the ceramic chip antenna) that feedline and GND are connected is a basic PIFA antenna structure. And, another pad on the other side that only GND is connected is for capacitive loading. Loaded capacitive value is optimized by the gap distance between two pads on the top surface. In PIFA, there is short mechanism usually in proximity to feed. This RF shorting affects impedance and current distribution mechanism of antenna. The actual antenna top face can seem to be mirrored, however it can be used same as the non-mirrored version. Please follow the design recommendation specified in this data sheet for either case.

Description: 2.4GHz Ceramic Chip Antenna

Series: Ceramic Chip Antenna

PART NUMBER: W3008G

OTHER SPECIFICATIONS

PWB Layout

Typical performance (test board size 80x37 mm, PWB ground clearance area 11.00 x 6.25 mm) Antenna placed 80mm edge center position.

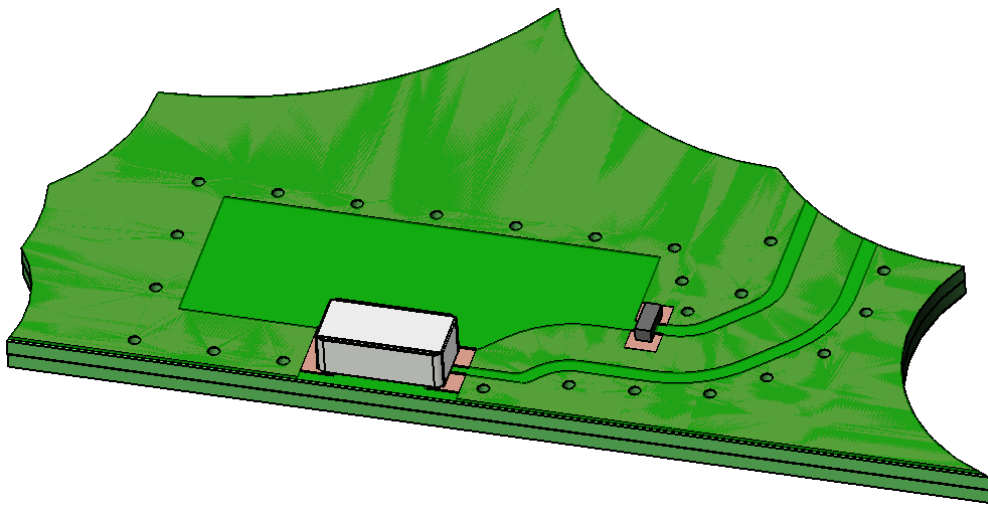
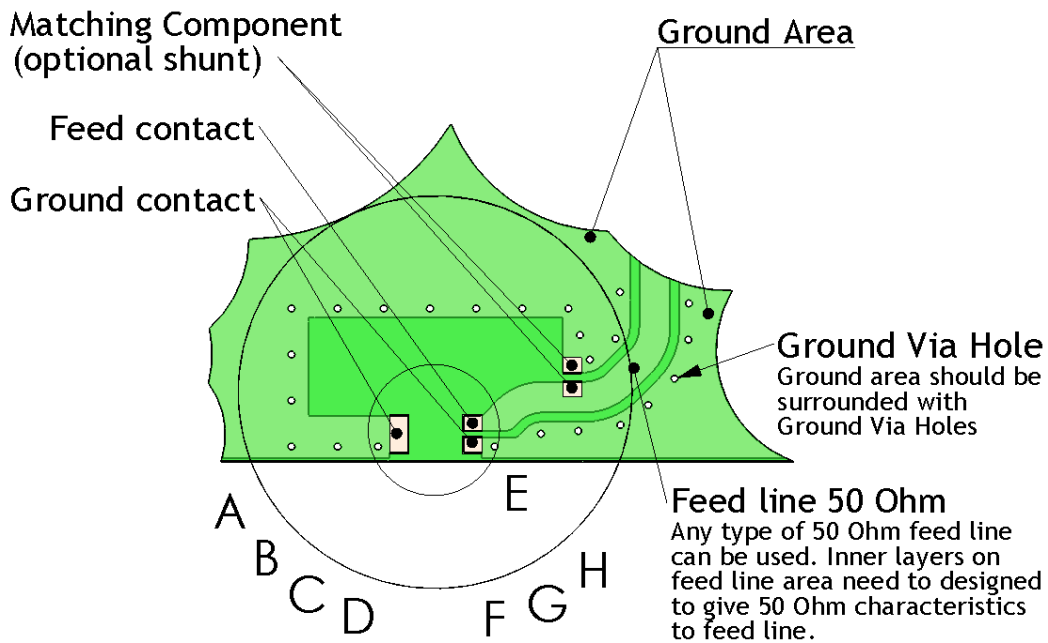

Issue: 1946

In the effort to improve our products, we reserve the right to make changes judged to be necessary.

CONFIDENTIAL AND PROPRIETARY INFORMATION

This document contains confidential and proprietary information of Pulse Electronics, Inc. (Pulse) and is protected by copyright, trade secret and other state and federal laws. Its receipt or possession does not convey any rights to reproduce, disclose its contents, or to manufacture, use or sell anything it may describe. Reproduction, disclosure or use without specific written authorization of Pulse is strictly forbidden.

Description: 2.4GHz Ceramic Chip Antenna

Series: Ceramic Chip Antenna

PART NUMBER: W3008G

OTHER SPECIFICATIONS

Ground cleared under antenna, clearance area 11.00 x 6.25 mm

Ground clearance area (11,00 x 6,25 mm)

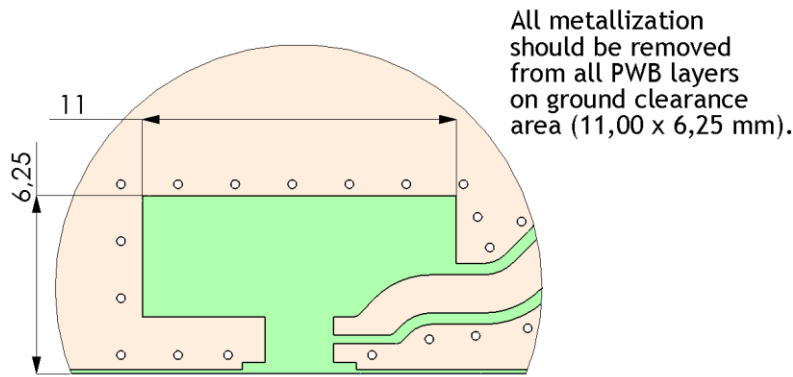

DETAIL A

Opening in bottom/inner ground layers

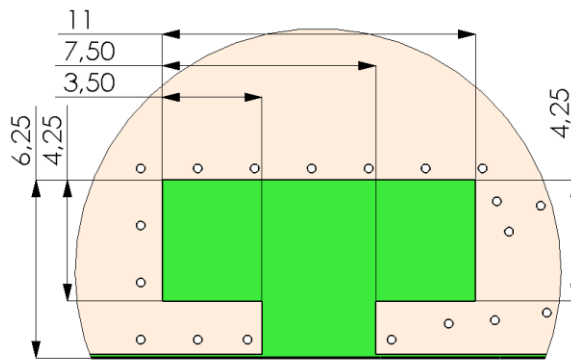

DETAIL B

Opening in other layers (no ground/ RF)

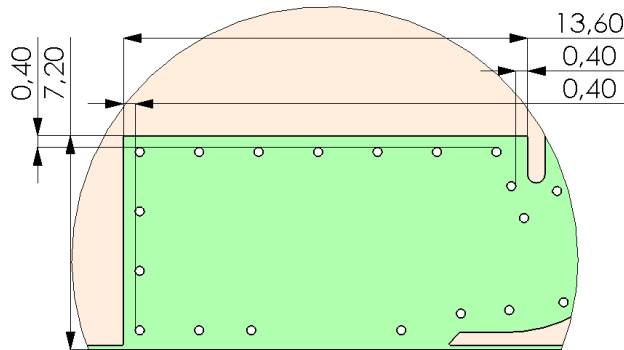

DETAIL C

Issue: 1946

In the effort to improve our products, we reserve the right to make changes judged to be necessary.

CONFIDENTIAL AND PROPRIETARY INFORMATION

This document contains confidential and proprietary information of Pulse Electronics, Inc. (Pulse) and is protected by copyright, trade secret and other state and federal laws. Its receipt or possession does not convey any rights to reproduce, disclose its contents, or to manufacture, use or sell anything it may describe. Reproduction, disclosure or use without specific written authorization of Pulse is strictly forbidden.

Description: 2.4GHz Ceramic Chip Antenna

Series: Ceramic Chip Antenna

PART NUMBER: W3008G

OTHER SPECIFICATIONS

PWB pad dimensions and antenna position

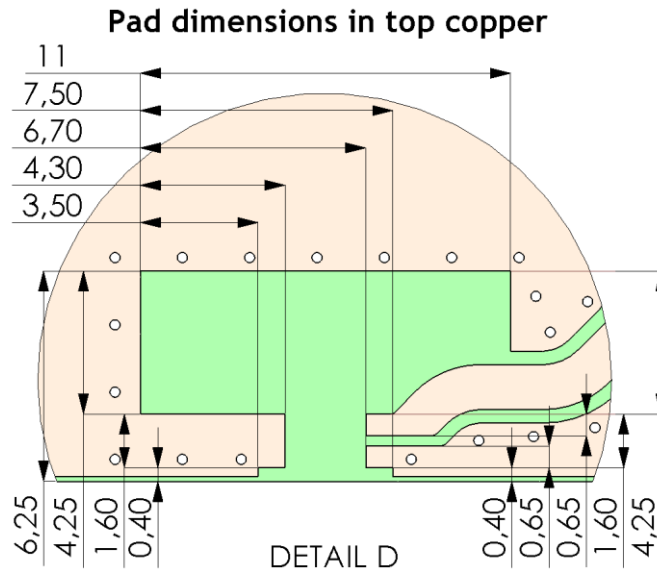

Antenna position on PWB layout

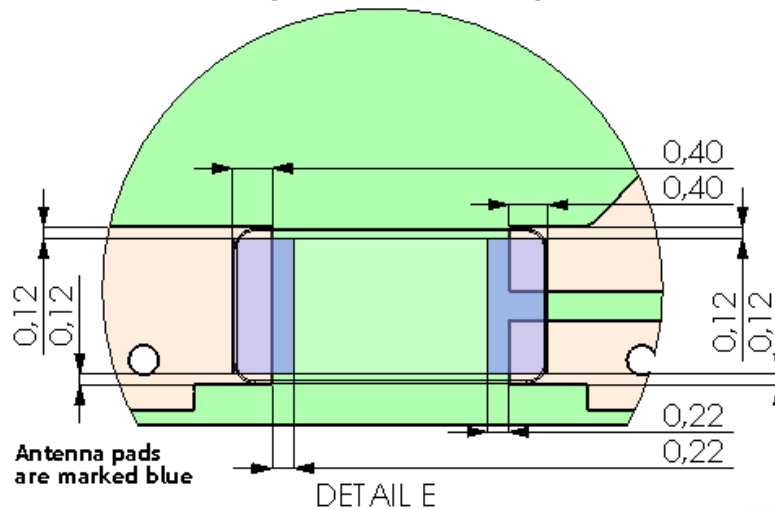

Issue: 1946

In the effort to improve our products, we reserve the right to make changes judged to be necessary.

CONFIDENTIAL AND PROPRIETARY INFORMATION

This document contains confidential and proprietary information of Pulse Electronics, Inc. (Pulse) and is protected by copyright, trade secret and other state and federal laws. Its receipt or possession does not convey any rights to reproduce, disclose its contents, or to manufacture, use or sell anything it may describe. Reproduction, disclosure or use without specific written authorization of Pulse is strictly forbidden.

Description: 2.4GHz Ceramic Chip Antenna

Series: Ceramic Chip Antenna

PART NUMBER: W3008G

OTHER SPECIFICATIONS

Typical Ground via hole placement in PWB layout

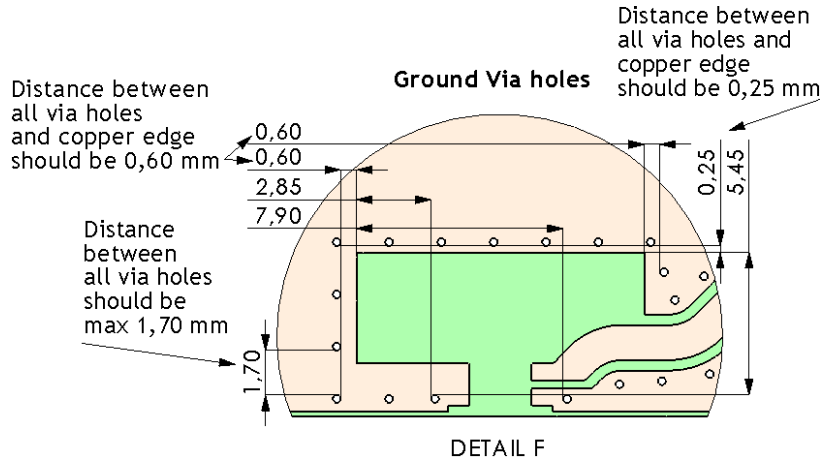

Solder resist opening and paste stencil recommendations

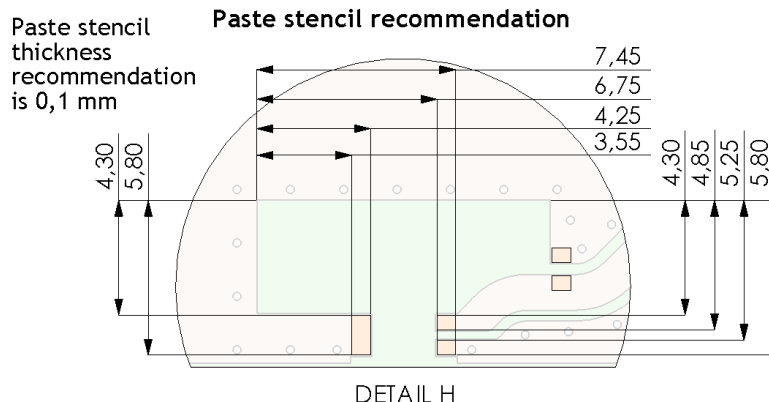
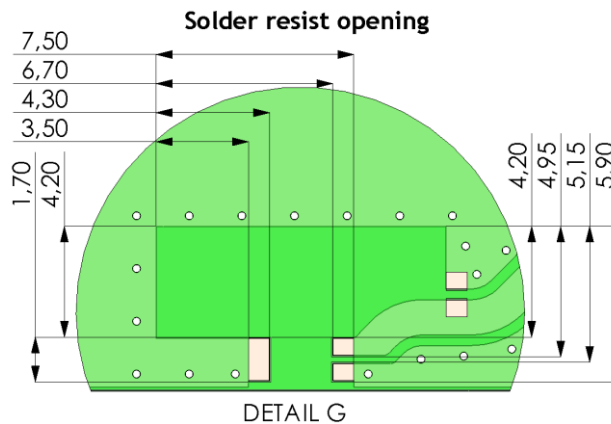

Issue: 1946

In the effort to improve our products, we reserve the right to make changes judged to be necessary.

CONFIDENTIAL AND PROPRIETARY INFORMATION

This document contains confidential and proprietary information of Pulse Electronics, Inc. (Pulse) and is protected by copyright, trade secret and other state and federal laws. Its receipt or possession does not convey any rights to reproduce, disclose its contents, or to manufacture, use or sell anything it may describe. Reproduction, disclosure or use without specific written authorization of Pulse is strictly forbidden.

Description: 2.4GHz Ceramic Chip Antenna

Series: Ceramic Chip Antenna

PART NUMBER: W3008G

TEST SETUP

All RF parameters measured on 37x80mm evaluation board.
Antenna placement on side center position of PCB long edge.
Shunt 1.2pF capacitor for matching.

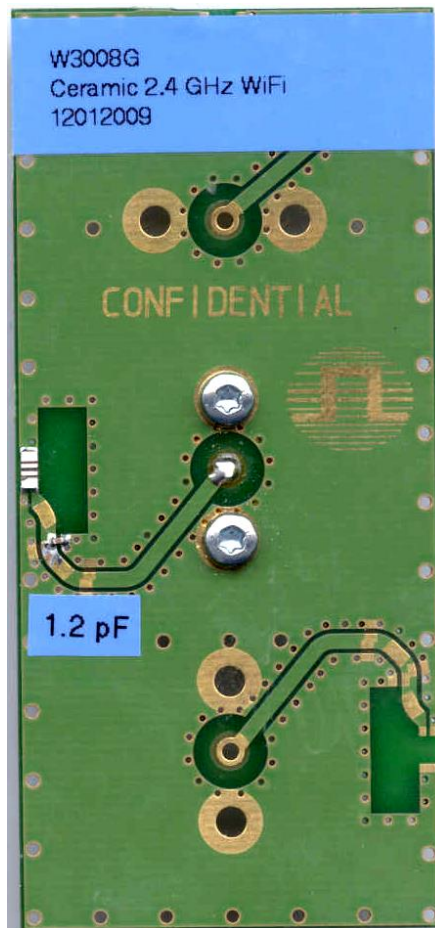

Description: 2.4GHz Ceramic Chip Antenna

Series: Ceramic Chip Antenna

PART NUMBER: W3008G

CHARTS

VSWR

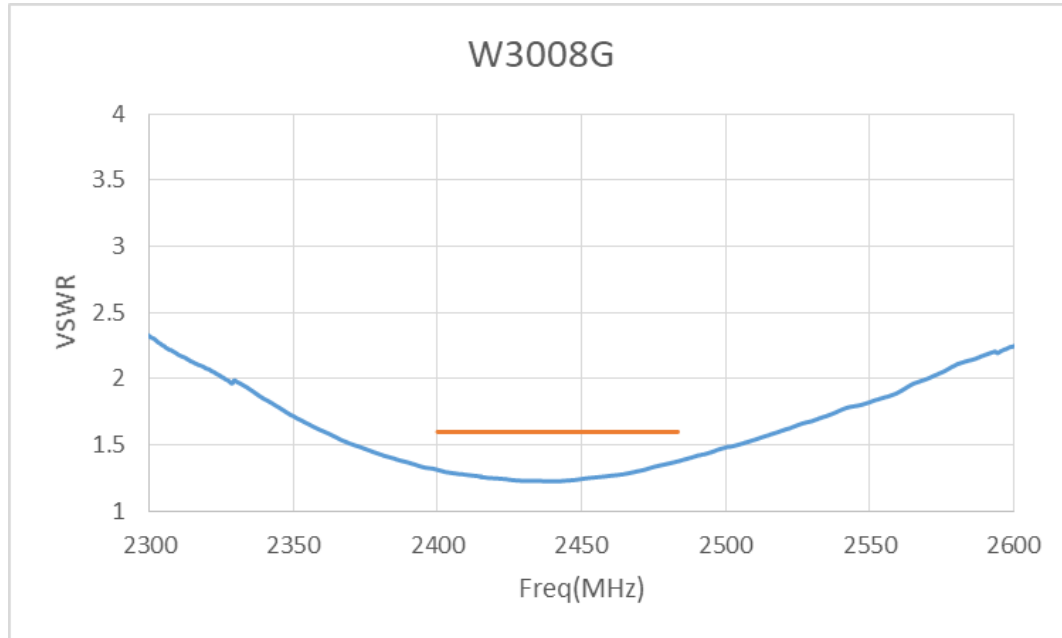

Peak Gain



Issue: 1946

In the effort to improve our products, we reserve the right to make changes judged to be necessary.

CONFIDENTIAL AND PROPRIETARY INFORMATION

This document contains confidential and proprietary information of Pulse Electronics, Inc. (Pulse) and is protected by copyright, trade secret and other state and federal laws. Its receipt or possession does not convey any rights to reproduce, disclose its contents, or to manufacture, use or sell anything it may describe. Reproduction, disclosure or use without specific written authorization of Pulse is strictly forbidden.

Description: 2.4GHz Ceramic Chip Antenna

Series: Ceramic Chip Antenna

PART NUMBER: W3008G

CHARTS

Radiation Efficiency

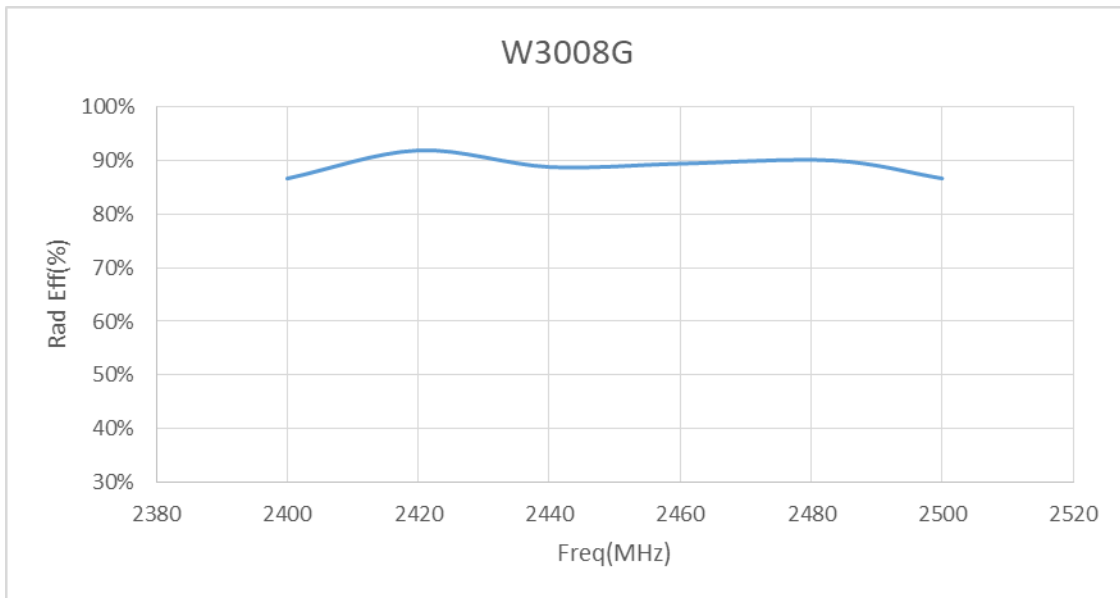

Radiation pattern X-Y plane

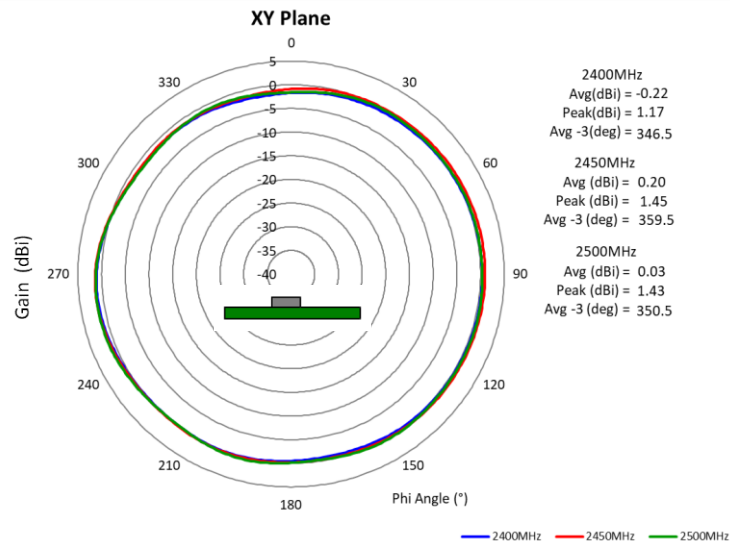

Issue: 1946

In the effort to improve our products, we reserve the right to make changes judged to be necessary.

CONFIDENTIAL AND PROPRIETARY INFORMATION

This document contains confidential and proprietary information of Pulse Electronics, Inc. (Pulse) and is protected by copyright, trade secret and other state and federal laws. Its receipt or possession does not convey any rights to reproduce, disclose its contents, or to manufacture, use or sell anything it may describe. Reproduction, disclosure or use without specific written authorization of Pulse is strictly forbidden.

Description: 2.4GHz Ceramic Chip Antenna

Series: Ceramic Chip Antenna

PART NUMBER: W3008G

CHARTS

Radiation pattern Z-X plane

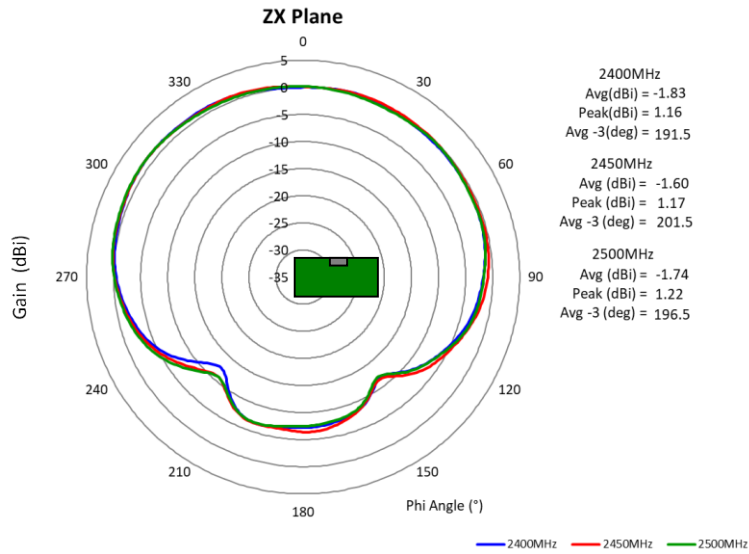

Radiation pattern Y-Z plane

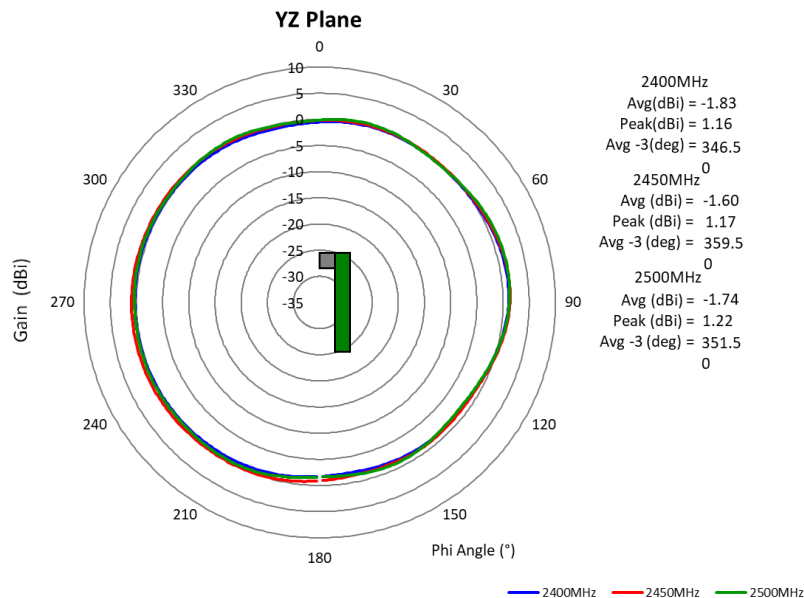

Issue: 1946

In the effort to improve our products, we reserve the right to make changes judged to be necessary.

CONFIDENTIAL AND PROPRIETARY INFORMATION

This document contains confidential and proprietary information of Pulse Electronics, Inc. (Pulse) and is protected by copyright, trade secret and other state and federal laws. Its receipt or possession does not convey any rights to reproduce, disclose its contents, or to manufacture, use or sell anything it may describe. Reproduction, disclosure or use without specific written authorization of Pulse is strictly forbidden.

Description: 2.4GHz Ceramic Chip Antenna

Series: Ceramic Chip Antenna

PART NUMBER: W3008G

Recommendation for reflow soldering process

Printing stencil thickness 0,15 - 0,25 mm is recommended for the solder paste. The maximum soldering temperature should not exceed 260°C. The temperature profile recommendations for reflow soldering process is presented in the Figures 1 and 2. The reflow profile

presented in figure 1 describes minimum reflow temperatures. The reflow profile presented in figure 2 describes maximum reflow temperatures. located at the center of the coverage area.

	Method of heat transfer	Controlled hot air convection
1	Average temperature gradient in preheating	2.5 °C/s
2	Soak time	2-3 minutes
3	Max temperature gradient in reflow	3 °C/s
4	Time above 217 °C	Max 30 sec
5	Peak temperature in reflow	230 °C for 10 seconds
6	Temperature gradient in cooling	Max -5 °C/s

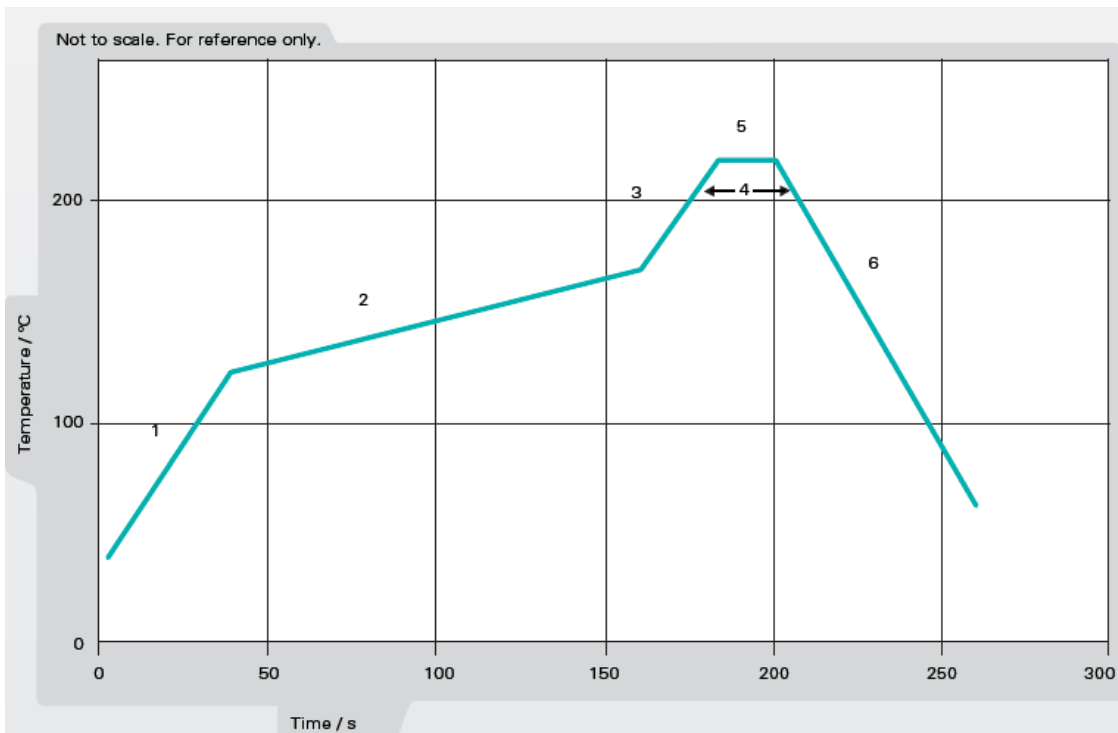

Figure 1. Minimum temperature profile recommendation for reflow soldering process

Issue: 1946

In the effort to improve our products, we reserve the right to make changes judged to be necessary.

CONFIDENTIAL AND PROPRIETARY INFORMATION

This document contains confidential and proprietary information of Pulse Electronics, Inc. (Pulse) and is protected by copyright, trade secret and other state and federal laws. Its receipt or possession does not convey any rights to reproduce, disclose its contents, or to manufacture, use or sell anything it may describe. Reproduction, disclosure or use without specific written authorization of Pulse is strictly forbidden.

Description: 2.4GHz Ceramic Chip Antenna

Series: Ceramic Chip Antenna

PART NUMBER: W3008G

Recommendation for reflow soldering process

	Method of heat transfer	Controlled hot air convection
1	Average temperature gradient in preheating	2.5 °C/s
2	Soak time	2-3 minutes
3	Max temperature gradient in reflow	3 °C/s
4	Time above 217 °C	Max 60 sec
5	Time above 230 °C	Max 50 sec
6	Time above 250 °C	Max 10 sec
7	Peak temperature in reflow	260 °C for 5 seconds
8	Temperature gradient in cooling	Max -5 °C/s

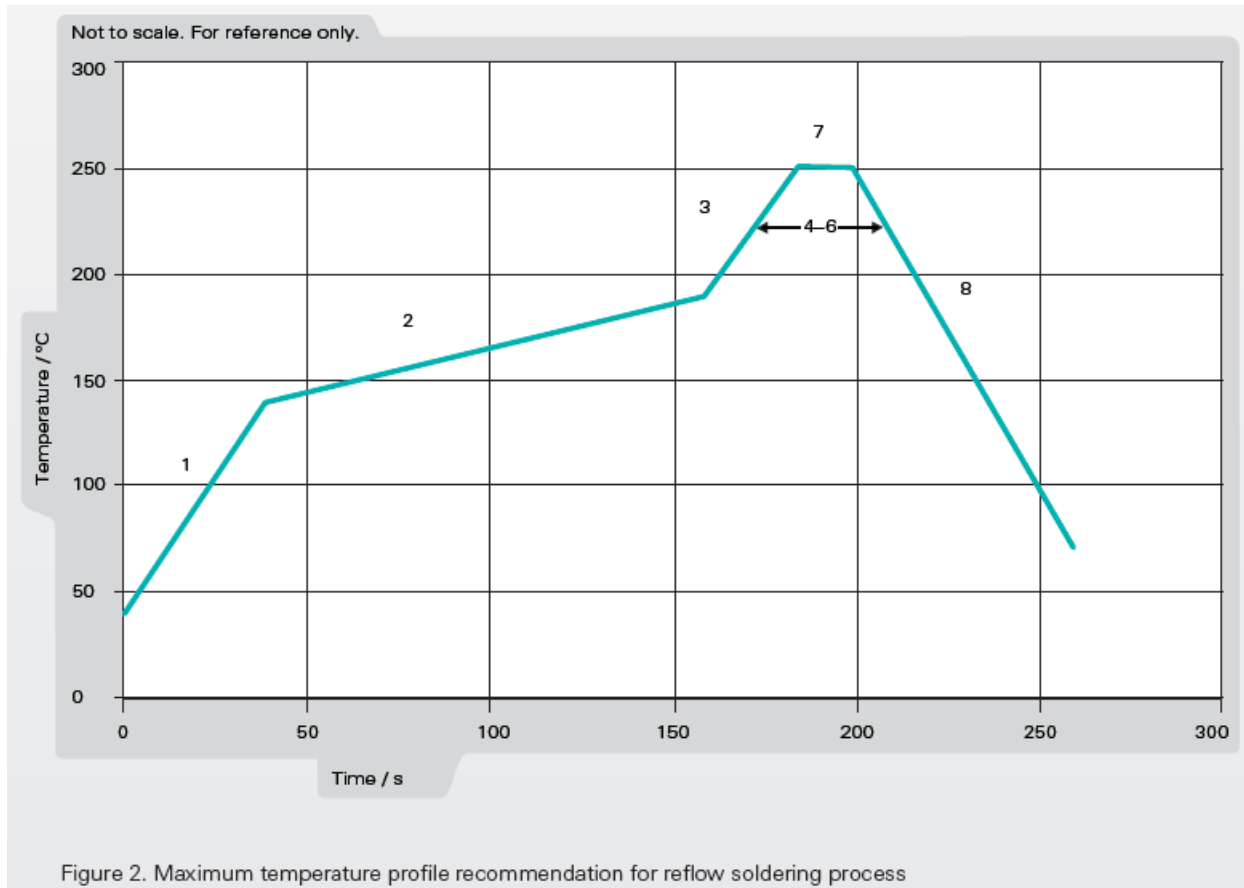

Issue: 1946

In the effort to improve our products, we reserve the right to make changes judged to be necessary.

CONFIDENTIAL AND PROPRIETARY INFORMATION

This document contains confidential and proprietary information of Pulse Electronics, Inc. (Pulse) and is protected by copyright, trade secret and other state and federal laws. Its receipt or possession does not convey any rights to reproduce, disclose its contents, or to manufacture, use or sell anything it may describe. Reproduction, disclosure or use without specific written authorization of Pulse is strictly forbidden.

Description: 2.4GHz Ceramic Chip Antenna

Series: Ceramic Chip Antenna

PART NUMBER: W3008G

PACKAGING-1

- 3000pcs antennas per 7" reel
- 5pcs 7" reel per inner package box
- 2pcs inner box per out box
- Total 30000pcs antenna per out box
- Out box size: 390mmx215mmx165mm

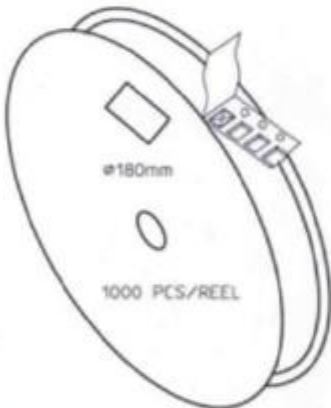
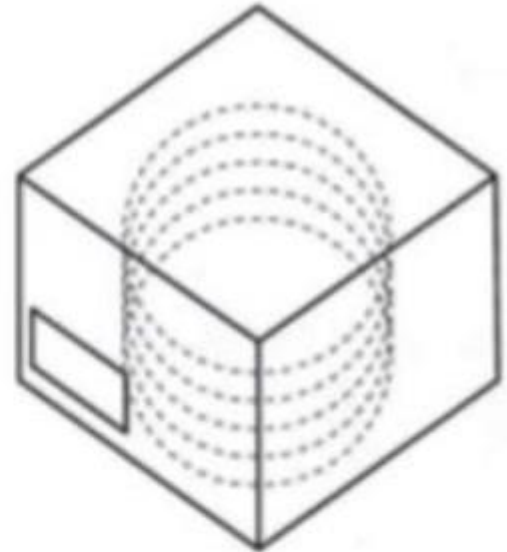

NOT MOISTURE SENSITIVE	LEVEL 1
<p>These Devices do not require special storage conditions provided:</p> <ol style="list-style-type: none"> 1. They are maintained at conditions equal to or less than 30°C and 85% RH. 2. They are solder reflowed at a peak body temperature which does not exceed 260°C. <p>Note: Level 1 and body temperature defined by IPC/JEDEC J-STD-020</p>	

Issue: 1946

In the effort to improve our products, we reserve the right to make changes judged to be necessary.

CONFIDENTIAL AND PROPRIETARY INFORMATION

This document contains confidential and proprietary information of Pulse Electronics, Inc. (Pulse) and is protected by copyright, trade secret and other state and federal laws. Its receipt or possession does not convey any rights to reproduce, disclose its contents, or to manufacture, use or sell anything it may describe. Reproduction, disclosure or use without specific written authorization of Pulse is strictly forbidden.

Description: 2.4GHz Ceramic Chip Antenna

Series: Ceramic Chip Antenna

PART NUMBER: W3008G

PACKAGING-2

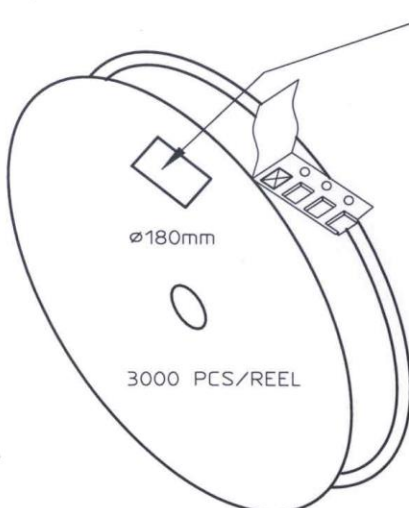

REEL LABEL INFORMATION:
 - TRACEABILITY
 - QUANTITY
 - PRODUCT CODE

CARRIER TAPE H85-00125
 width=8,00 depth=1,22
 COVER TAPE H85-00126
 width=5,60

LENGTH OF TAPE:
 - Leader section: min 350 mm before component section
 - Trailer section: min 40 mm after component section.

Empty part cavities at leader and trailer section of the tape must be sealed with top cover tape.

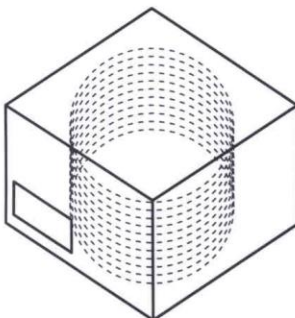

BOX H85-00128 (182x182x132)	1 pcs
- LABEL	1 pcs/BOX
REEL H85-00127 (D180, W12)	10 pcs
- REEL LABEL	1 pcs/REEL

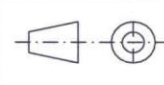
MATERIAL				
HANDLINGS				
		RATIO	DRWN 090507 PeHa H	
			DGNER	G
			CHKD	F
			APPRD	E
PRODUCT	H90-OY805	APPRD BY	D	
DENOMINATION	PACKING FORM		C	
			B	
			A	
	VERSION	MOD/DATE/NAME		

Issue: 1946

In the effort to improve our products, we reserve the right to make changes judged to be necessary.

CONFIDENTIAL AND PROPRIETARY INFORMATION

This document contains confidential and proprietary information of Pulse Electronics, Inc. (Pulse) and is protected by copyright, trade secret and other state and federal laws. Its receipt or possession does not convey any rights to reproduce, disclose its contents, or to manufacture, use or sell anything it may describe. Reproduction, disclosure or use without specific written authorization of Pulse is strictly forbidden.

单击下面可查看定价，库存，交付和生命周期等信息

[>>Pulse\(普思\)](#)