

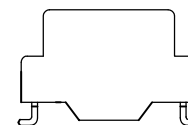

NOTES:

1. ROHS COMPLIANT
2. PLASTIC: THERMOSET PLASTIC MATERIAL WITH FLAMMABILITY RATING UL 94V-0 OR BETTER.
3. STORAGE TEMPERATURE: -50°C TO +125°C
4. COMPLIANCE TO J-STD:
 - A. J-STD-002: SOLDERABILITY AT 245°C REFLOW PROFILE
 - B. J-STD-020: LEVEL 1, NO MOISTURE SENSITIVE
 - C. J-STD-075: R7, 245°C MAXIMUM THROUGH REFLOW SOLDER
5. TO ORDER TAPE & REEL PACKAGING ADD A "T" SUFFIX TO THE PART NUMBER(i.e HX2019FNL BECOMES HX2019FNLT).

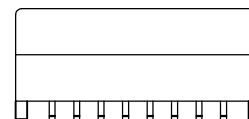

FINAL OUTLINE

© Copyright, 2018. Pulse Electronics Corp. All rights reserved. Pulse confidential & proprietary. (05/14/18)

PRODUCT DESCRIPTION	TLA DRAWING	PS DRAWING	SHEET	PART NO.	DATASHEET REV.
MDL,SIN,100P,1:1,SM,TU	HX2019FNL-11	PS-2005.002-D	1 OF 3	HX2019FNL	B

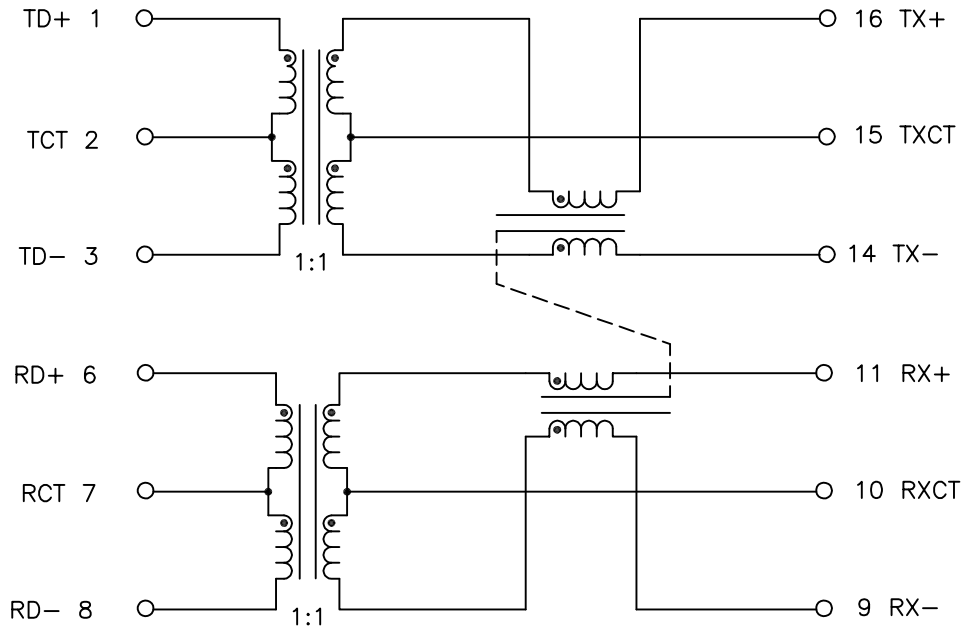

SCHEMATIC

ELECTRICAL CHARACTERISTICS AT +25°C UNLESS OTHERWISE SPECIFIED
(FOR REFERENCE ONLY. USED FOR CUSTOMER INFORMATION.)

PARAMETER	SPECIFICATIONS		
OPERATING TEMP	-40°C TO +85°C		
TURNS RATIO	1.00 ± 2%		
POLARITY	PER SCHEMATIC		
INSERTION LOSS	100 KHz	1-125 MHz	
	-1.2 dB MAX	-0.2-0.002*f ^{1.4} dB MAX	
RETURN LOSS, 1000BT (Z OUT = 100 OHM ±15%)	.1-30 MHz	30-60 MHz	60-80 MHz
	-16 dB MIN	-10+20*LOG ₁₀ (f/60 MHz) dB MIN	
		-10 dB MIN	
INDUCTANCE (OCL) (MEDIA SIDE, -40°C TO +85°C)	350 uH MIN* (MEASURED AT 100 KHz, 100 mVRMS AND WITH 8 mA DC BIAS)		
CROSSTALK, ADJACENT CHANNELS	1 MHz	10-100 MHz	
	-50 dB MIN	-55+22*LOG ₁₀ (f/10) dB MIN	
COMMON MODE REJECTION RATIO	2 MHz	30-200 MHz	
	-45 dB MIN	-7+28*LOG ₁₀ (f/200) dB MIN	
DC RESISTANCE, 1/2 WINDING	.75 OHMS MAX		
DC CURRENT/VOLTAGE, RATING - PSE PINS	350 mA MAX, @ 57 V (CONTINUOUS)		
DC RESISTANCE IMBALANCE	±.065 OHMS MAX (CENTER TAP SYMMETRY)		
INPUT - OUTPUT ISOLATION	1500 VRMS MIN AT 60 SECONDS		

NOTES: f IS FREQUENCY IN MHz.

* = 325 uH AT -40°C

© Copyright, 2018. Pulse Electronics Corp. All rights reserved. Pulse confidential & proprietary. (05/14/18)

PRODUCT DESCRIPTION	TLA DRAWING	PS DRAWING	SHEET	PART NO.	DATASHEET REV.
MDL,SIN,100P,1:1,SM,TU	HX2019FNL-11	PS-2005.002-D	2 OF 3	HX2019FNL	B

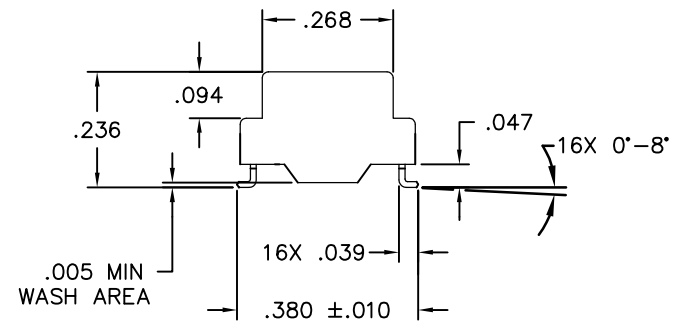
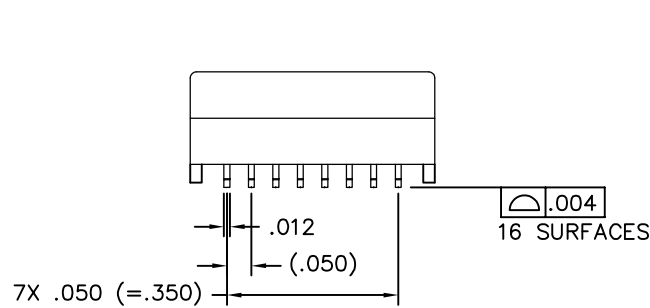
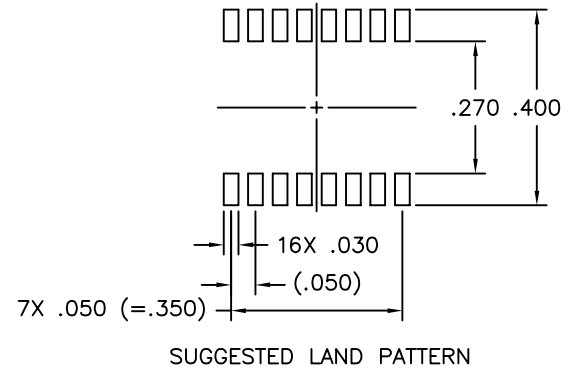
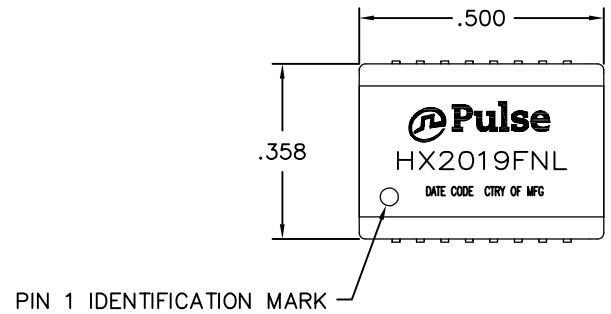

DIMENSIONS ARE IN INCHES WITH THE FOLLOWING TOLERANCES:
.XX= ±.01
.XXX= ±.005

© Copyright, 2018. Pulse Electronics Corp. All rights reserved. Pulse confidential & proprietary. (05/14/18)

PRODUCT DESCRIPTION	TLA DRAWING	PS DRAWING	SHEET	PART NO.	DATASHEET REV.
MDL,SIN,100P,1:1,SM,TU	HX2019FNL-11	PS-2005.002-D	3 OF 3	HX2019FNL	B

单击下面可查看定价，库存，交付和生命周期等信息

[>>Pulse\(普思\)](#)