

Description: 2X LTE, 2XWiFi Vehicular Antenna

Series: Low Profile MB

PART NUMBER: LPMB40X



Features:

- 2xMiMo 698-960/1710-2690MHz
- WiFi 2400-2500/4900-5900MHz
- Size 145x135x25mm
- Adhesive mount on plastic and glass fiber surfaces
- Mounting accessory for metallic surfaces



Applications:

- Vehicle mount multiband antenna
- High Speed LTE data and WiFi
- Fleet management
- Utility Vans (Gas, Water, Electricity)

All dimensions are in mm / inches

Issue: 1922

In the effort to improve our products, we reserve the right to make changes judged to be necessary.

CONFIDENTIAL AND PROPRIETARY INFORMATION

This document contains confidential and proprietary information of Pulse Electronics, Inc. (Pulse) and is protected by copyright, trade secret and other state and federal laws. Its receipt or possession does not convey any rights to reproduce, disclose its contents, or to manufacture, use or sell anything it may describe. Reproduction, disclosure or use without specific written authorization of Pulse is strictly forbidden.

For more information:

Pulse Worldwide Headquarters
15255 Innovation Drive #100
San Diego, CA 92128
USA
Tel: 1-858-674-8100

Pulse/Larsen Antennas
18110 SE 34th St Bldg 2 Suite 250
Vancouver, WA 98683
USA
Tel: 1-360-944-7551

Europe Headquarters
Pulse GmbH & Do, KG
Zeppelinstrasse 15
Herrenberg, Germany

Pulse (Suzhou) Wireless Products Co, Inc.
99 Huo Ju Road(#29 Bldg,4th Phase
Suzhou New District
Jiangsu Province, Suzhou 215009 PR China
Tel: 86 512 6807 9998

Description: 2X LTE, 2XWiFi Vehicular Antenna

Series: Low Profile MB

PART NUMBER: LPMB40X

ELECTRICAL SPECIFICATIONS

LTE Antenna

Frequency	698-960/1710-2690 MHz
Nominal Impedance	50 Ω
VSWR(*)	2.5 Max
Average Efficiency(698-960MHz)(**)	64 %
Average Efficiency(1710-2690MHz) (**)	57 %
Peak Gain(698-960MHz) (**)	2.0 dBi
Peak Gain(1710-2690MHz) (**)	4.4 dBi

WIFI Antenna

Frequency	2400-2500/4900-5900 MHz
Nominal Impedance	50 Ω
VSWR (*)	2 Max
Average Efficiency(2400-2500MHz) (**)	63 %
Average Efficiency(4900-5900MHz) (**)	73 %
Peak Gain(2400-2500MHz) (**)	3.5 dBi
Peak Gain(4900-5900MHz) (**)	4.7 dBi

* Measured on 500mm ground plane with LMR195 3m cable

** Measured on 500mm ground plane with LMR195 320mm cable

Description: 2X LTE, 2XWiFi Vehicular Antenna

Series: Low Profile MB

PART NUMBER: LPMB40X

MECHANICAL SPECIFICATIONS

Antenna P/N	Antenna Color / Material	Weight	Cable and Connector type		Cable length	Mounting System
LPMB401	SABIC PC943, Black	607g	LTE-1	LMR195* SMA Male	3Meters / 118.11Inchs	Adhesive Tape 3mmThick 3M VHB 4959
			LTE-2	LMR195* SMA Male		
			WiFi-1	LMR195* RP-SMA Male		
			WiFi-2	LMR195* RP-SMA Male		
LPMB405		492g	LTE-1	LMR195* SMA Male	2Meters / 78.74Inchs	
			LTE-2	LMR195* SMA Male		
			WiFi-1	LMR195* RP-SMA Male		
			WiFi-2	LMR195* RP-SMA Male		

* Or Equivalent

ENVIRONMENTAL SPECIFICATIONS

Operating Temperature	-40 ~ +85° C
Ingress Protection	IP67
RoHS Compliant	Yes

Issue: 1922

In the effort to improve our products, we reserve the right to make changes judged to be necessary.

CONFIDENTIAL AND PROPRIETARY INFORMATION

This document contains confidential and proprietary information of Pulse Electronics, Inc. (Pulse) and is protected by copyright, trade secret and other state and federal laws. Its receipt or possession does not convey any rights to reproduce, disclose its contents, or to manufacture, use or sell anything it may describe. Reproduction, disclosure or use without specific written authorization of Pulse is strictly forbidden.

Description: 2X LTE, 2XWiFi Vehicular Antenna

Series: Low Profile MB

PART NUMBER: LPMB40X

MECHANICAL DRAWING

LPMB401

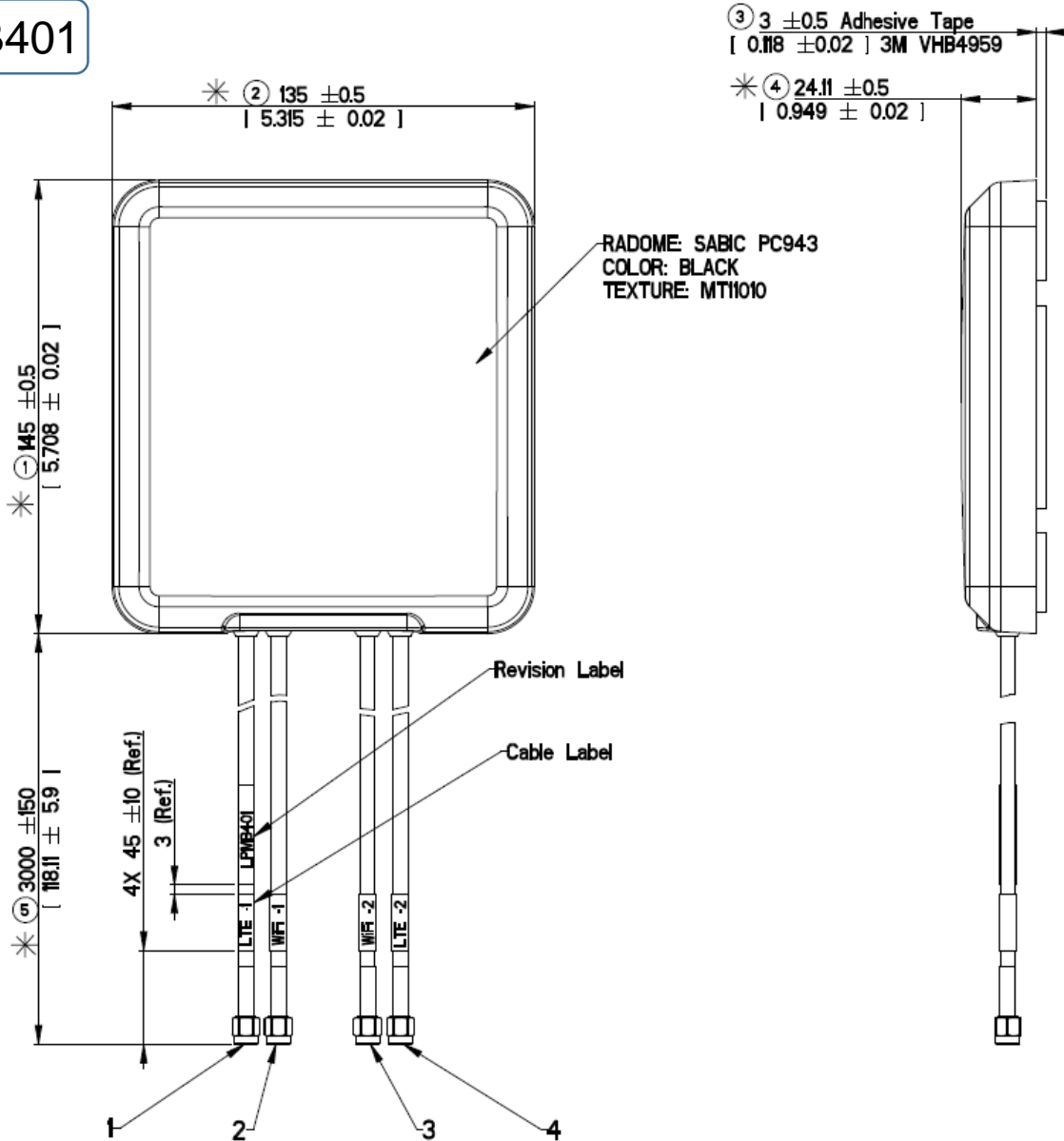

LPMB401	P/N	CABLE	CABLE LENGTH	CONNECTOR
1. LTE-1 Cable Assy	125-01188.001	LMR-195	3 Meters 9.84FT/118.11"	SMA Male
2. WiFi-1 Cable Assy	125-01190.001			RP-SMA Male
3. WiFi-2 Cable Assy	125-01191.001			RP-SMA Male
4. LTE-2 Cable Assy	125-01189.001			SMA Male

• OR EQUIVALENT

Issue: 1922

In the effort to improve our products, we reserve the right to make changes judged to be necessary.

CONFIDENTIAL AND PROPRIETARY INFORMATION

This document contains confidential and proprietary information of Pulse Electronics, Inc. (Pulse) and is protected by copyright, trade secret and other state and federal laws. Its receipt or possession does not convey any rights to reproduce, disclose its contents, or to manufacture, use or sell anything it may describe. Reproduction, disclosure or use without specific written authorization of Pulse is strictly forbidden.

Description: 2X LTE, 2XWiFi Vehicular Antenna

Series: Low Profile MB

PART NUMBER: LPMB40X

MECHANICAL DRAWING

LPMB401

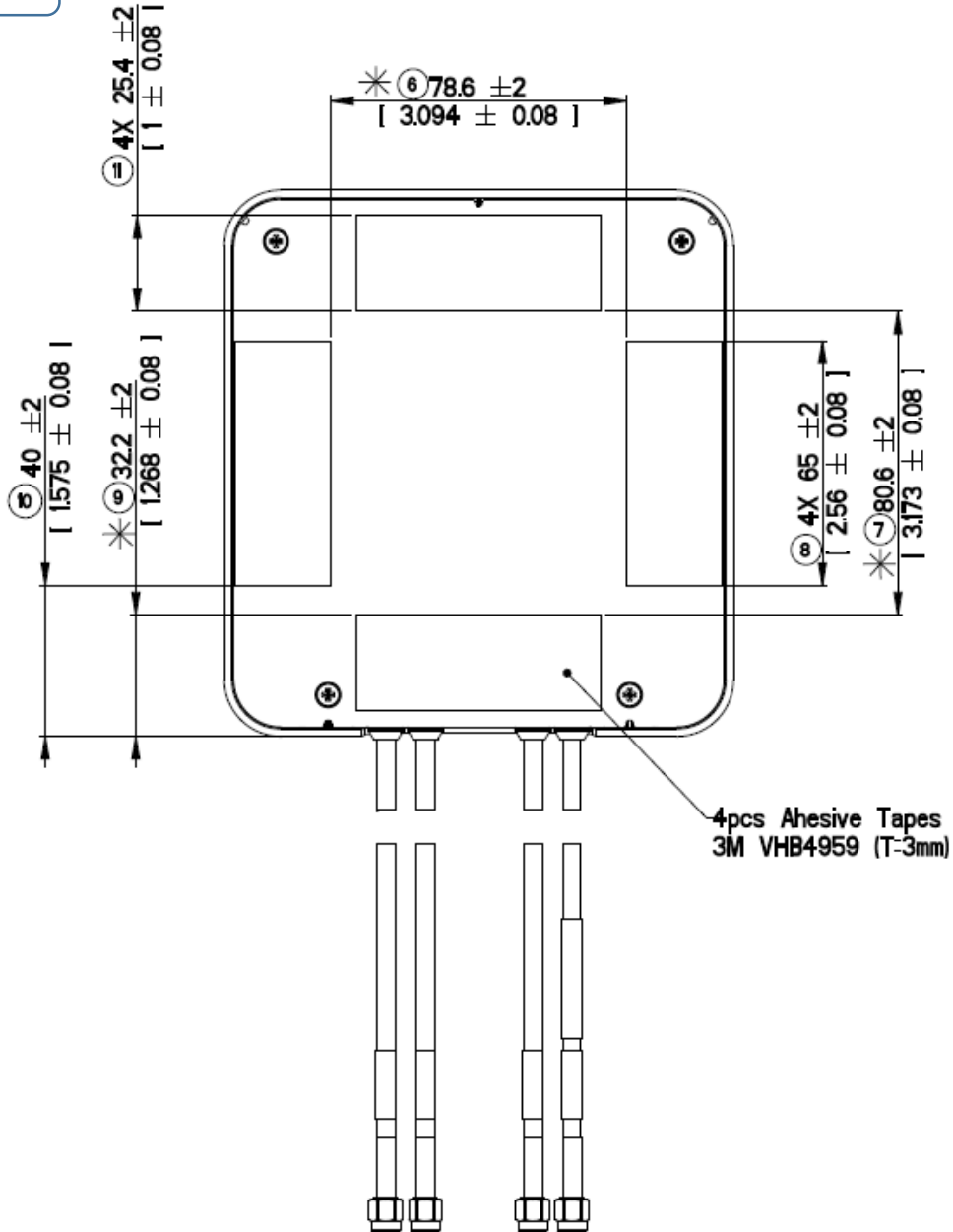

Issue: 1922

In the effort to improve our products, we reserve the right to make changes judged to be necessary.

CONFIDENTIAL AND PROPRIETARY INFORMATION

This document contains confidential and proprietary information of Pulse Electronics, Inc. (Pulse) and is protected by copyright, trade secret and other state and federal laws. Its receipt or possession does not convey any rights to reproduce, disclose its contents, or to manufacture, use or sell anything it may describe. Reproduction, disclosure or use without specific written authorization of Pulse is strictly forbidden.

Description: 2X LTE, 2XWiFi Vehicular Antenna

Series: Low Profile MB

PART NUMBER: LPMB40X

MECHANICAL DRAWING

LPMB405

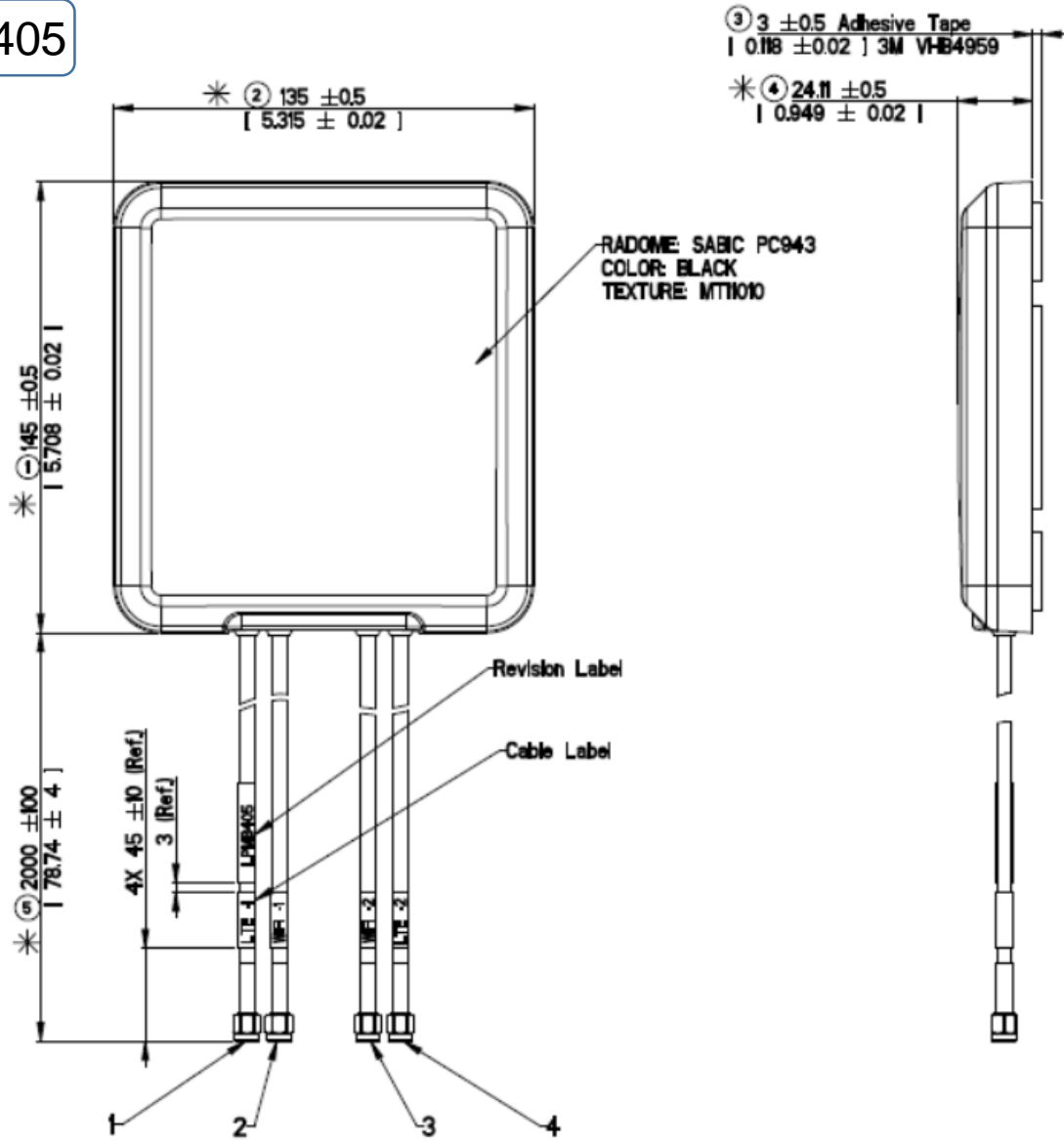

LPMB405	P.N.	CABLE	CABLE LENGTH	CONNECTOR
1. LTE-1 Cable Assy	125-00436.001	LMR-195	2 Meters [78.74]	SMA Male
2. WiFi-1 Cable Assy	125-00438.001			RP-SMA Male
3. WiFi-2 Cable Assy	125-00439.001			RP-SMA Male
4. LTE-2 Cable Assy	125-00437.001			SMA Male

• OR EQUIVALENT

Issue: 1922

In the effort to improve our products, we reserve the right to make changes judged to be necessary.

CONFIDENTIAL AND PROPRIETARY INFORMATION

This document contains confidential and proprietary information of Pulse Electronics, Inc. (Pulse) and is protected by copyright, trade secret and other state and federal laws. Its receipt or possession does not convey any rights to reproduce, disclose its contents, or to manufacture, use or sell anything it may describe. Reproduction, disclosure or use without specific written authorization of Pulse is strictly forbidden.

Description: 2X LTE, 2XWiFi Vehicular Antenna

Series: Low Profile MB

PART NUMBER: LPMB40X

MECHANICAL DRAWING

LPMB405

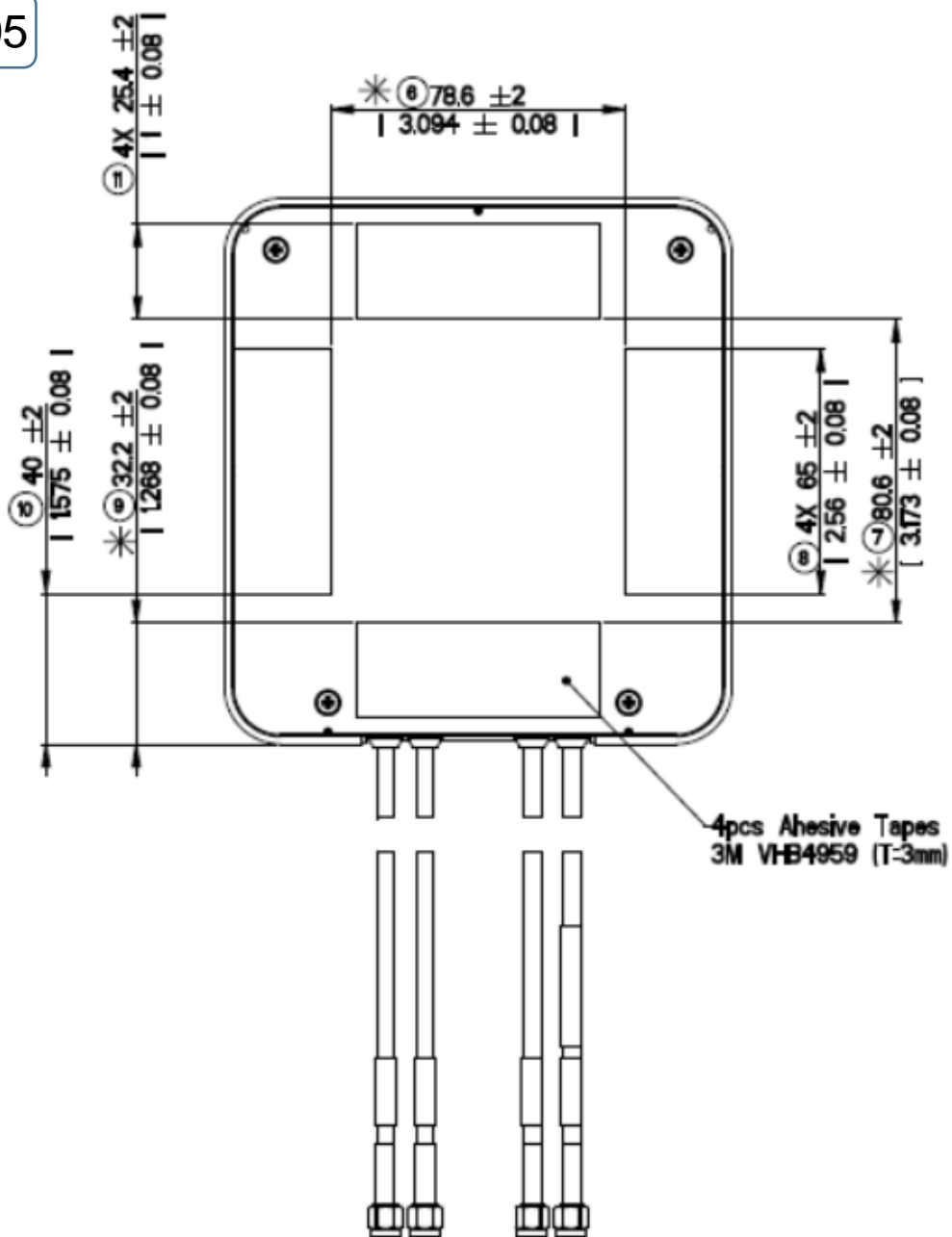

Issue: 1922

In the effort to improve our products, we reserve the right to make changes judged to be necessary.

CONFIDENTIAL AND PROPRIETARY INFORMATION

This document contains confidential and proprietary information of Pulse Electronics, Inc. (Pulse) and is protected by copyright, trade secret and other state and federal laws. Its receipt or possession does not convey any rights to reproduce, disclose its contents, or to manufacture, use or sell anything it may describe. Reproduction, disclosure or use without specific written authorization of Pulse is strictly forbidden.

Description: 2X LTE, 2XWiFi Vehicular Antenna

Series: Low Profile MB

PART NUMBER: LPMB40X

TEST SETUP

Below performance test in two situation

Situation 1 . Test in free space .

Situation 2. Test on 1 inch bracket with $\phi 500\text{mm}$ (19.7inch) ground.

Situation 1



Free space

Situation 2

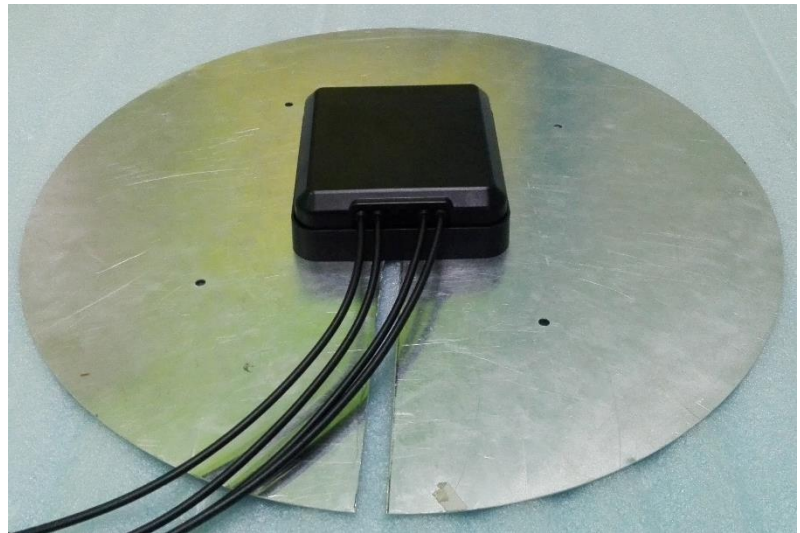

Ground plane $\phi = 500\text{mm}$ (19.7inch)
Bracket height=1inch

Description: 2X LTE, 2XWiFi Vehicular Antenna

Series: Low Profile MB

PART NUMBER: LPMB40X

CHARTS

Situation 1: Performance in free space



LTE 1 & LTE 2 VSWR

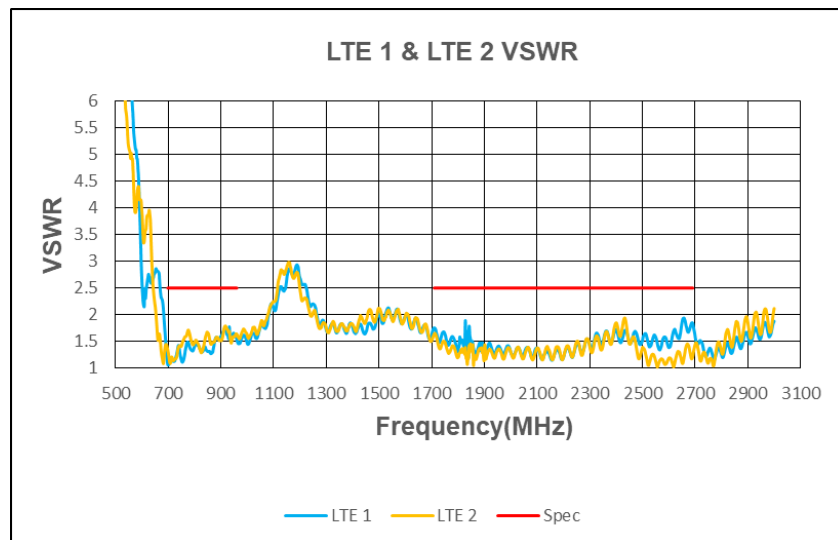

Note : Measured with 3m cable

Issue: 1922

In the effort to improve our products, we reserve the right to make changes judged to be necessary.

CONFIDENTIAL AND PROPRIETARY INFORMATION

This document contains confidential and proprietary information of Pulse Electronics, Inc. (Pulse) and is protected by copyright, trade secret and other state and federal laws. Its receipt or possession does not convey any rights to reproduce, disclose its contents, or to manufacture, use or sell anything it may describe. Reproduction, disclosure or use without specific written authorization of Pulse is strictly forbidden.

Description: 2X LTE, 2XWiFi Vehicular Antenna

Series: Low Profile MB

PART NUMBER: LPMB40X

CHARTS

WiFi1 & WiFi2 VSWR

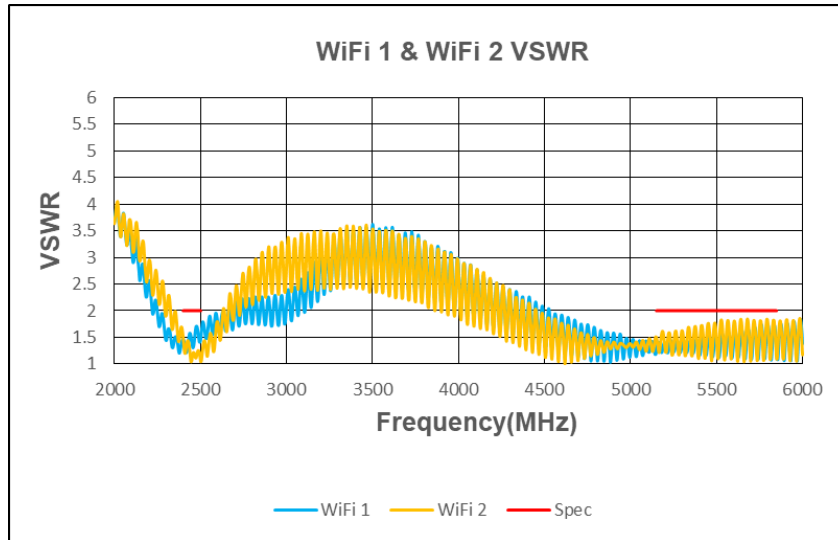

Isolation

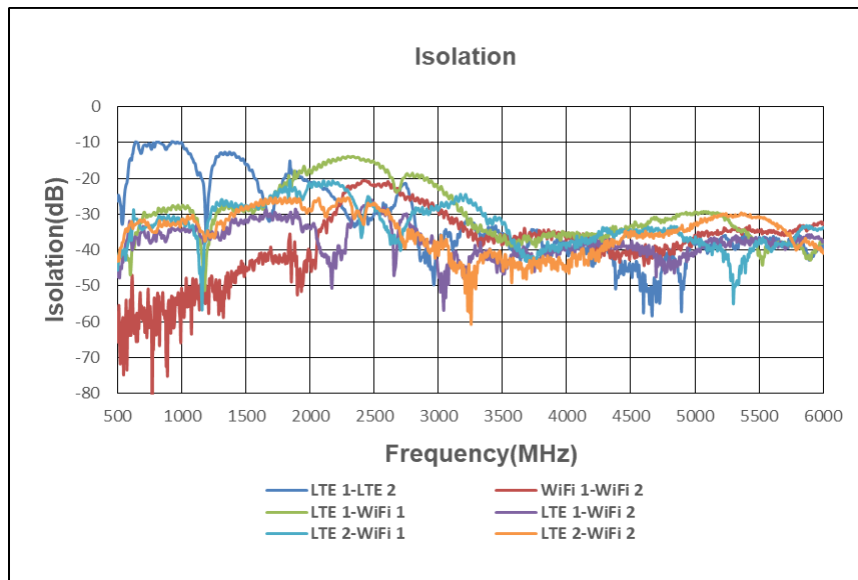

Note : Measured with 3m cable

Issue: 1922

In the effort to improve our products, we reserve the right to make changes judged to be necessary.

CONFIDENTIAL AND PROPRIETARY INFORMATION

This document contains confidential and proprietary information of Pulse Electronics, Inc. (Pulse) and is protected by copyright, trade secret and other state and federal laws. Its receipt or possession does not convey any rights to reproduce, disclose its contents, or to manufacture, use or sell anything it may describe. Reproduction, disclosure or use without specific written authorization of Pulse is strictly forbidden.

Description: 2X LTE, 2XWiFi Vehicular Antenna

Series: Low Profile MB

PART NUMBER: LPMB40X

CHARTS

LTE 1 and LTE2 Efficiency

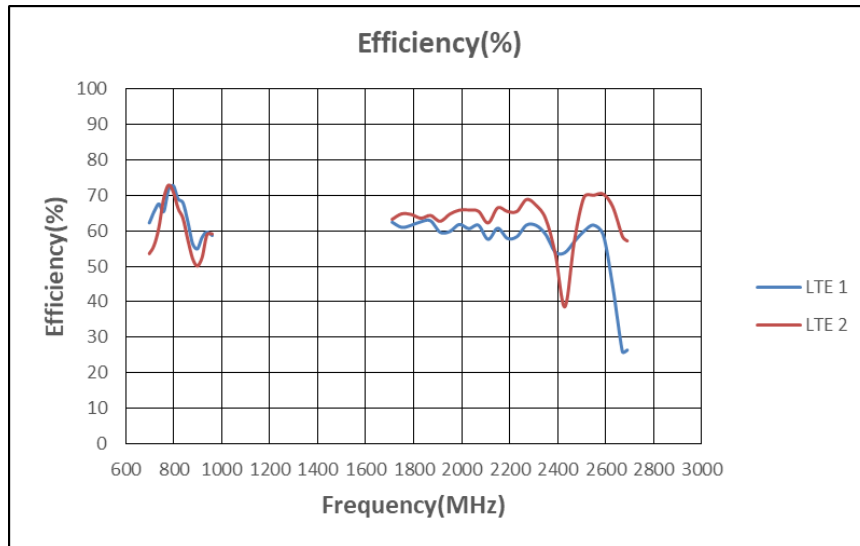

WiFi 1 and WiFi 2 Efficiency

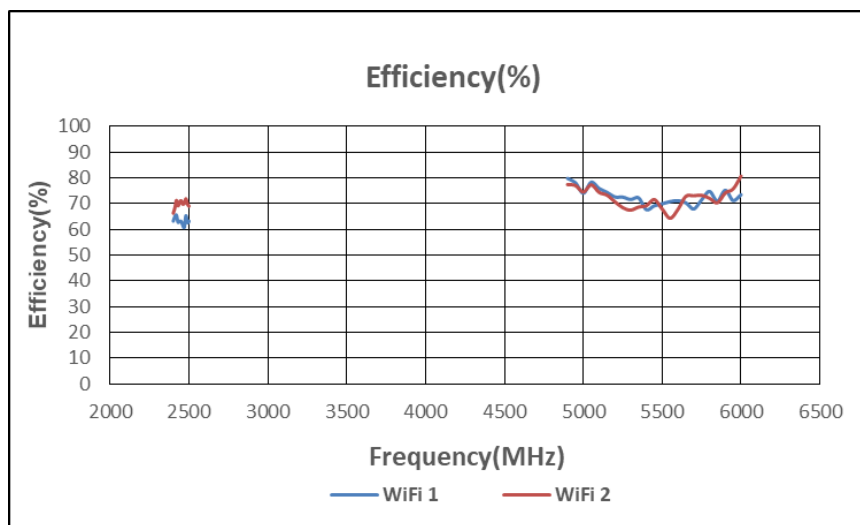

Note : Measured with 320mm cable

Issue: 1922

In the effort to improve our products, we reserve the right to make changes judged to be necessary.

CONFIDENTIAL AND PROPRIETARY INFORMATION

This document contains confidential and proprietary information of Pulse Electronics, Inc. (Pulse) and is protected by copyright, trade secret and other state and federal laws. Its receipt or possession does not convey any rights to reproduce, disclose its contents, or to manufacture, use or sell anything it may describe. Reproduction, disclosure or use without specific written authorization of Pulse is strictly forbidden.

Description: 2X LTE, 2XWiFi Vehicular Antenna

Series: Low Profile MB

PART NUMBER: LPMB40X

CHARTS

LTE 1 and LTE2 Peak Gain

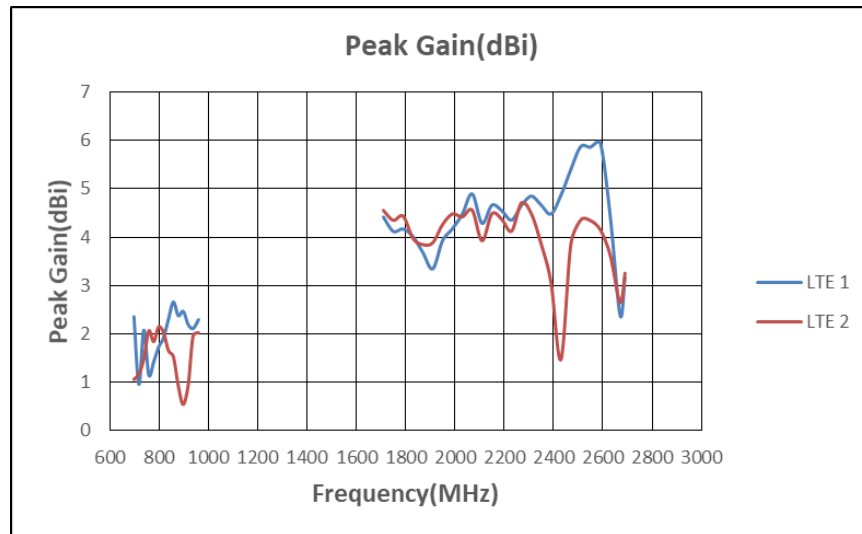

WiFi 1 and WiFi 2 Peak Gain

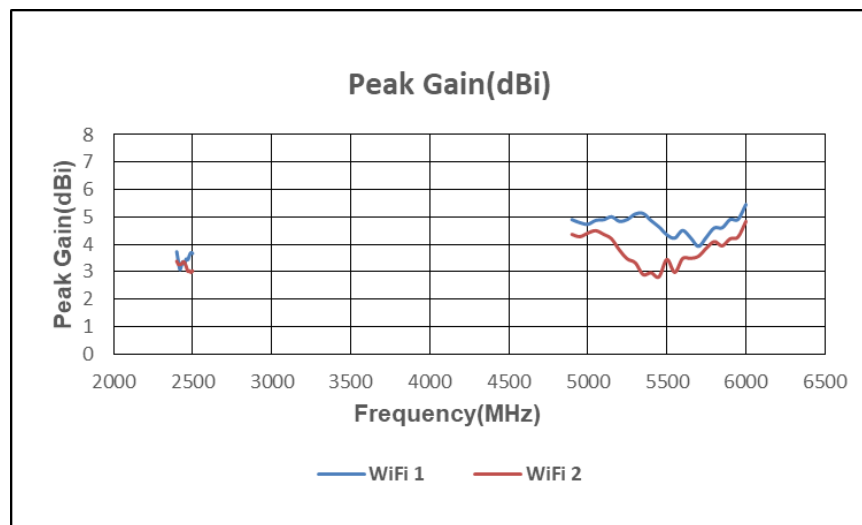

Note : Measured with 320mm cable

Issue: 1922

In the effort to improve our products, we reserve the right to make changes judged to be necessary.

CONFIDENTIAL AND PROPRIETARY INFORMATION

This document contains confidential and proprietary information of Pulse Electronics, Inc. (Pulse) and is protected by copyright, trade secret and other state and federal laws. Its receipt or possession does not convey any rights to reproduce, disclose its contents, or to manufacture, use or sell anything it may describe. Reproduction, disclosure or use without specific written authorization of Pulse is strictly forbidden.

Description: 2X LTE, 2XWiFi Vehicular Antenna

Series: Low Profile MB

PART NUMBER: LPMB40X

CHARTS

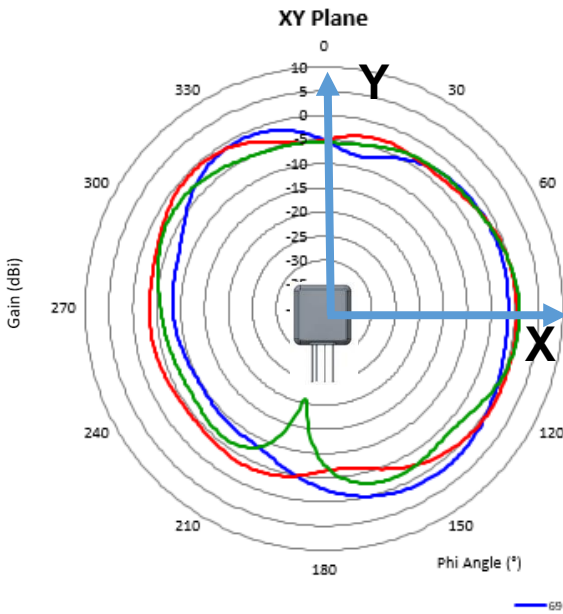

Gain Plots LTE 1

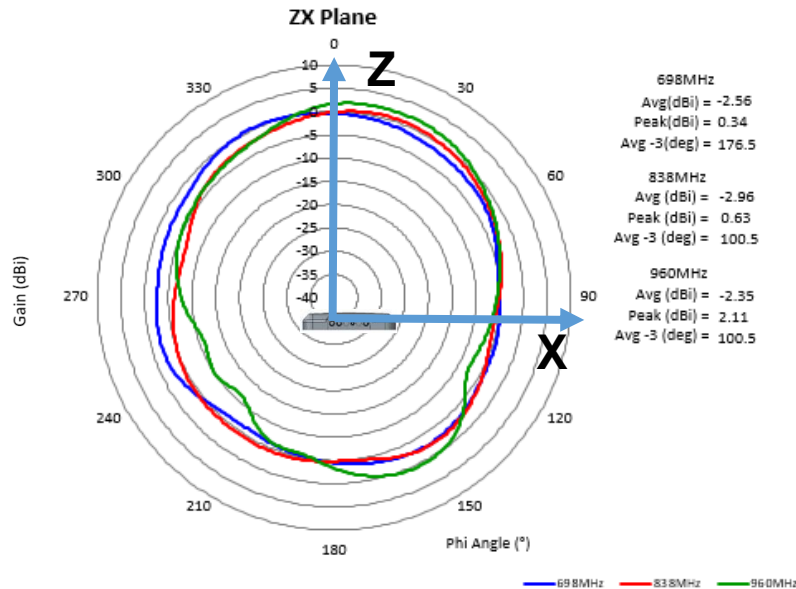

Gain Plots LTE 1

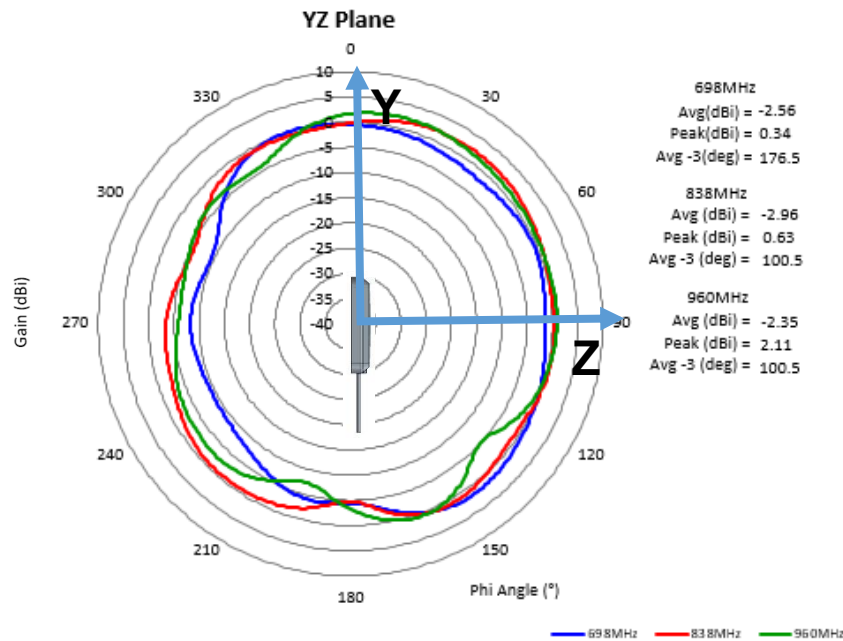

Gain Plots LTE 1

Issue: 1922

In the effort to improve our products, we reserve the right to make changes judged to be necessary.

CONFIDENTIAL AND PROPRIETARY INFORMATION

This document contains confidential and proprietary information of Pulse Electronics, Inc. (Pulse) and is protected by copyright, trade secret and other state and federal laws. Its receipt or possession does not convey any rights to reproduce, disclose its contents, or to manufacture, use or sell anything it may describe. Reproduction, disclosure or use without specific written authorization of Pulse is strictly forbidden.

Description: 2X LTE, 2XWiFi Vehicular Antenna

Series: Low Profile MB

PART NUMBER: LPMB40X

CHARTS

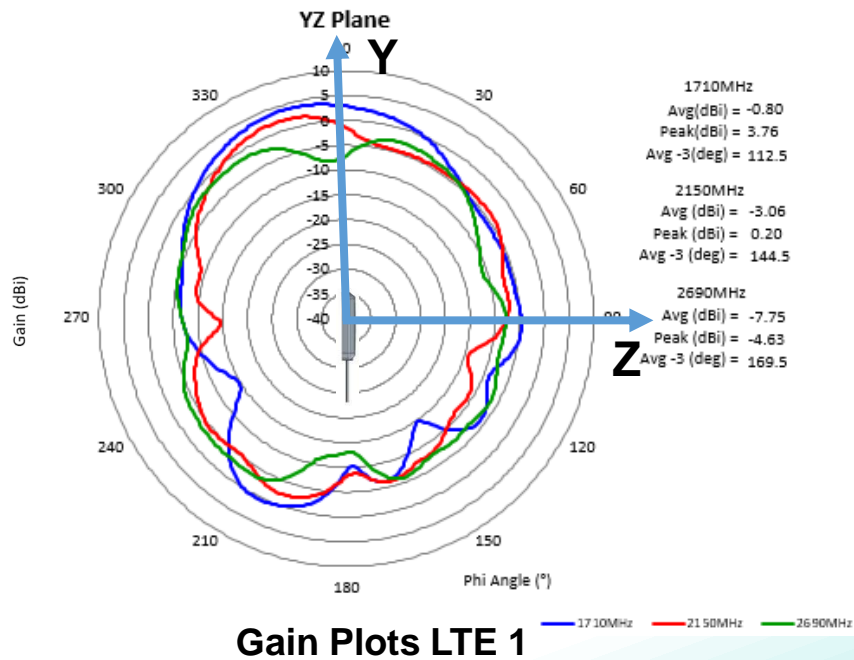
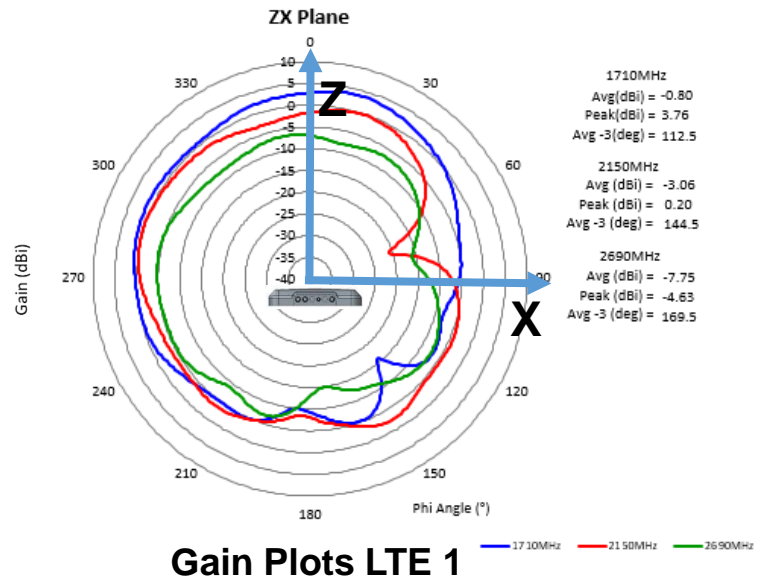
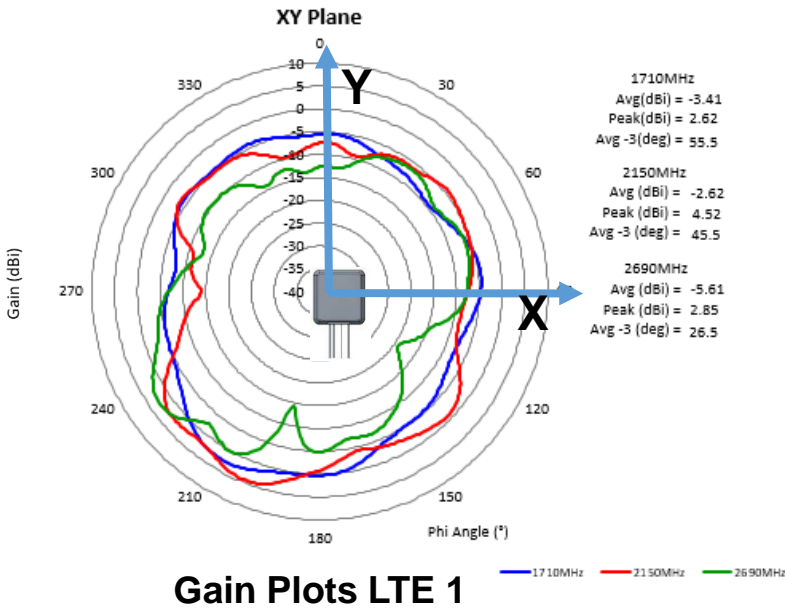

Issue: 1922

In the effort to improve our products, we reserve the right to make changes judged to be necessary.

CONFIDENTIAL AND PROPRIETARY INFORMATION

This document contains confidential and proprietary information of Pulse Electronics, Inc. (Pulse) and is protected by copyright, trade secret and other state and federal laws. Its receipt or possession does not convey any rights to reproduce, disclose its contents, or to manufacture, use or sell anything it may describe. Reproduction, disclosure or use without specific written authorization of Pulse is strictly forbidden.

Description: 2X LTE, 2XWiFi Vehicular Antenna

Series: Low Profile MB

PART NUMBER: LPMB40X

CHARTS

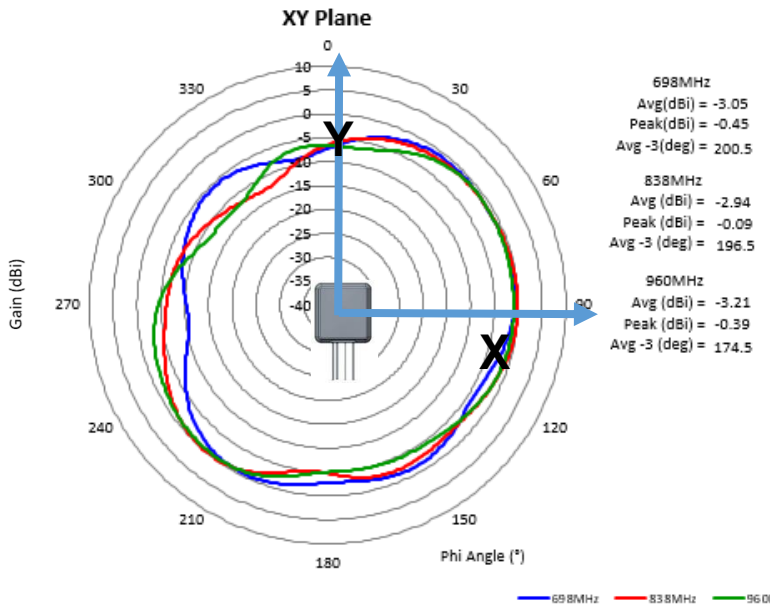

Gain Plots LTE 2

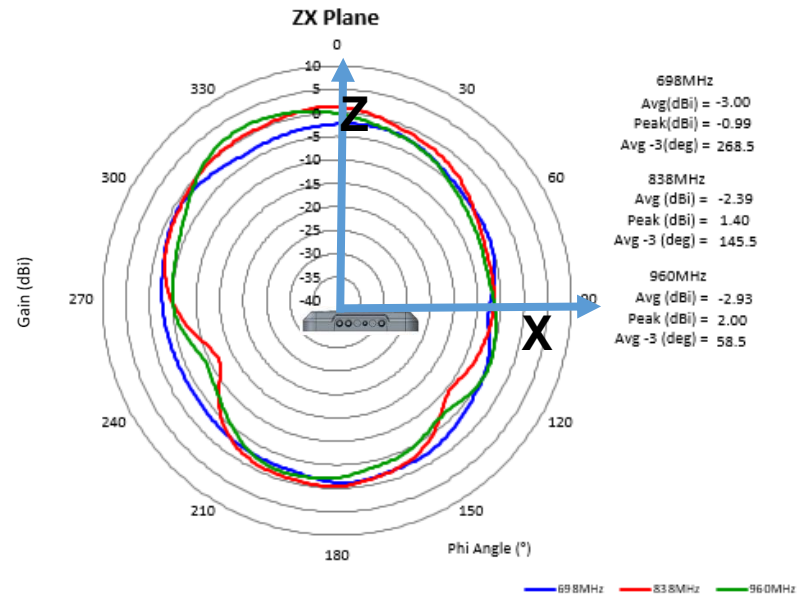

Gain Plots LTE 2

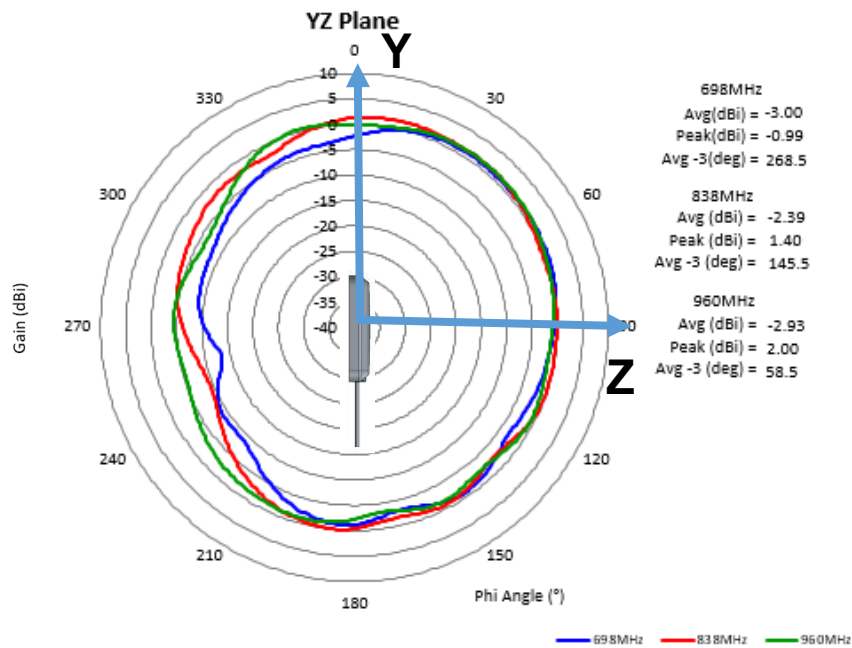

Gain Plots LTE 2

Issue: 1922

In the effort to improve our products, we reserve the right to make changes judged to be necessary.

CONFIDENTIAL AND PROPRIETARY INFORMATION

This document contains confidential and proprietary information of Pulse Electronics, Inc. (Pulse) and is protected by copyright, trade secret and other state and federal laws. Its receipt or possession does not convey any rights to reproduce, disclose its contents, or to manufacture, use or sell anything it may describe. Reproduction, disclosure or use without specific written authorization of Pulse is strictly forbidden.

Description: 2X LTE, 2XWiFi Vehicular Antenna

Series: Low Profile MB

PART NUMBER: LPMB40X

CHARTS

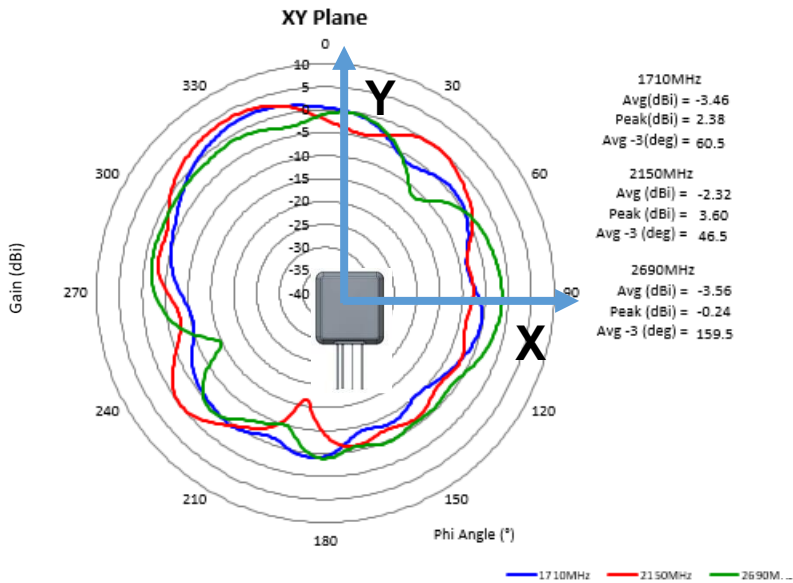

Gain Plots LTE 2

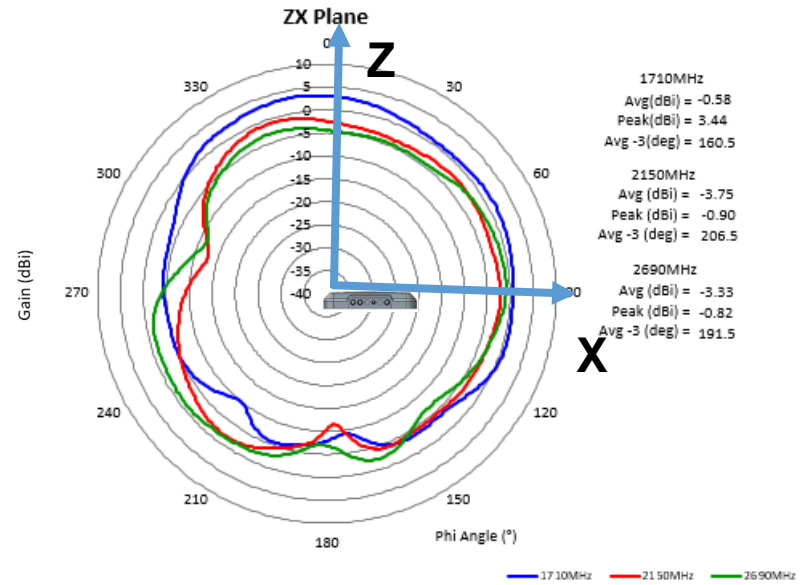

Gain Plots LTE 2

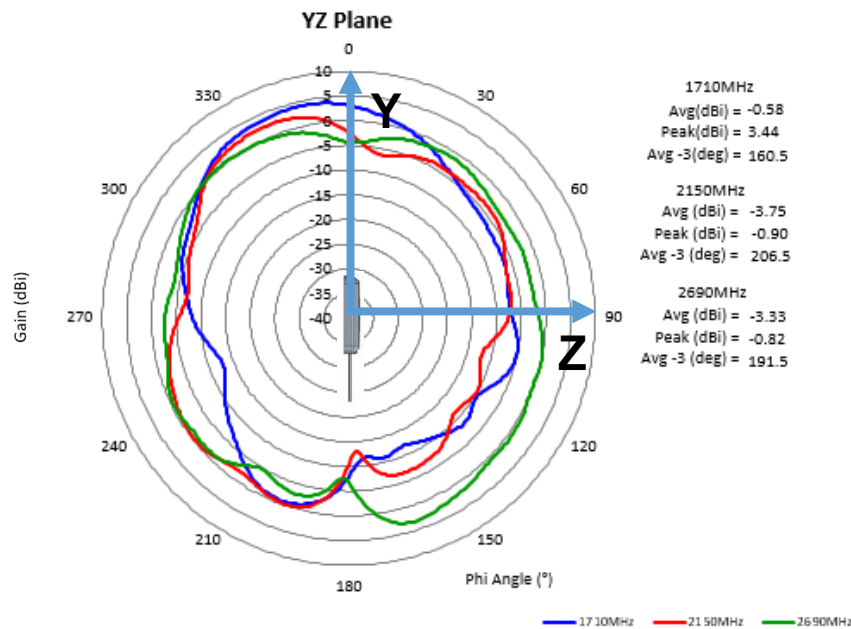

Gain Plots LTE 2

Issue: 1922

In the effort to improve our products, we reserve the right to make changes judged to be necessary.

CONFIDENTIAL AND PROPRIETARY INFORMATION

This document contains confidential and proprietary information of Pulse Electronics, Inc. (Pulse) and is protected by copyright, trade secret and other state and federal laws. Its receipt or possession does not convey any rights to reproduce, disclose its contents, or to manufacture, use or sell anything it may describe. Reproduction, disclosure or use without specific written authorization of Pulse is strictly forbidden.

Description: 2X LTE, 2XWiFi Vehicular Antenna

Series: Low Profile MB

PART NUMBER: LPMB40X

CHARTS

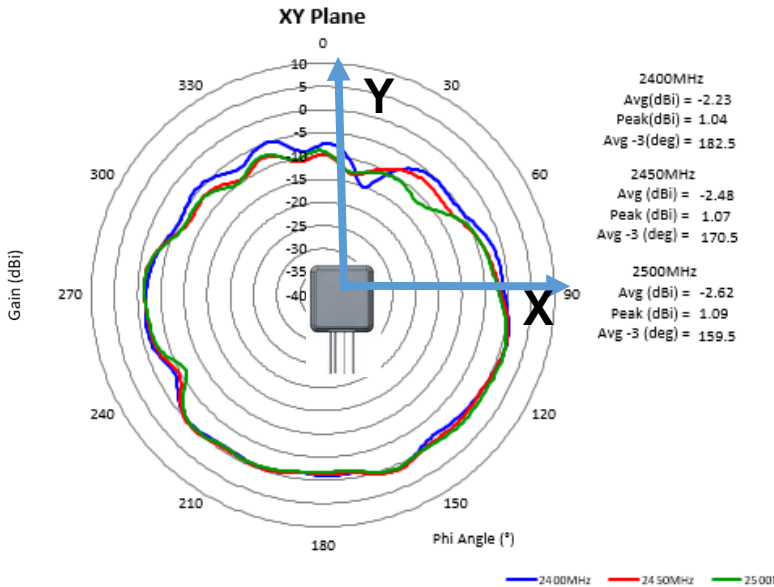

Gain Plots WiFi 1

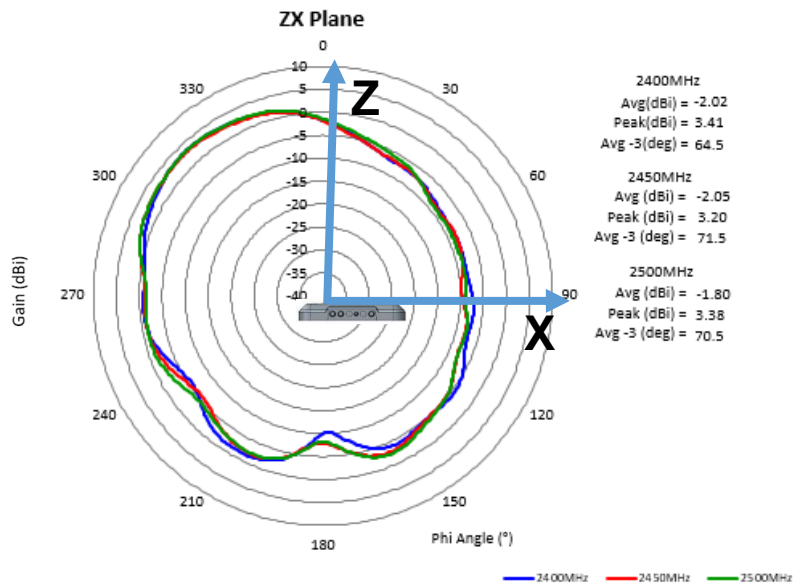

Gain Plots WiFi 1

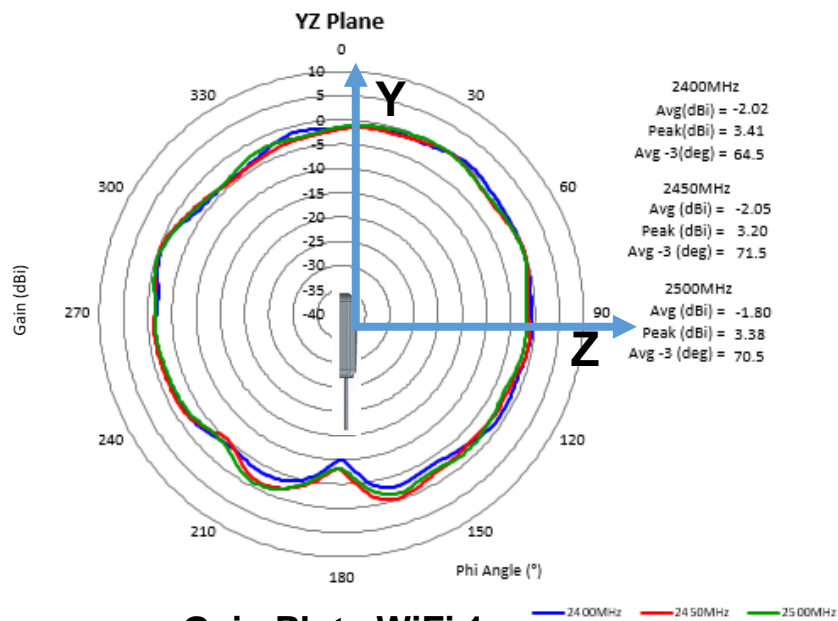

Gain Plots WiFi 1

Issue: 1922

In the effort to improve our products, we reserve the right to make changes judged to be necessary.

CONFIDENTIAL AND PROPRIETARY INFORMATION

This document contains confidential and proprietary information of Pulse Electronics, Inc. (Pulse) and is protected by copyright, trade secret and other state and federal laws. Its receipt or possession does not convey any rights to reproduce, disclose its contents, or to manufacture, use or sell anything it may describe. Reproduction, disclosure or use without specific written authorization of Pulse is strictly forbidden.

Description: 2X LTE, 2XWiFi Vehicular Antenna

Series: Low Profile MB

PART NUMBER: LPMB40X

CHARTS

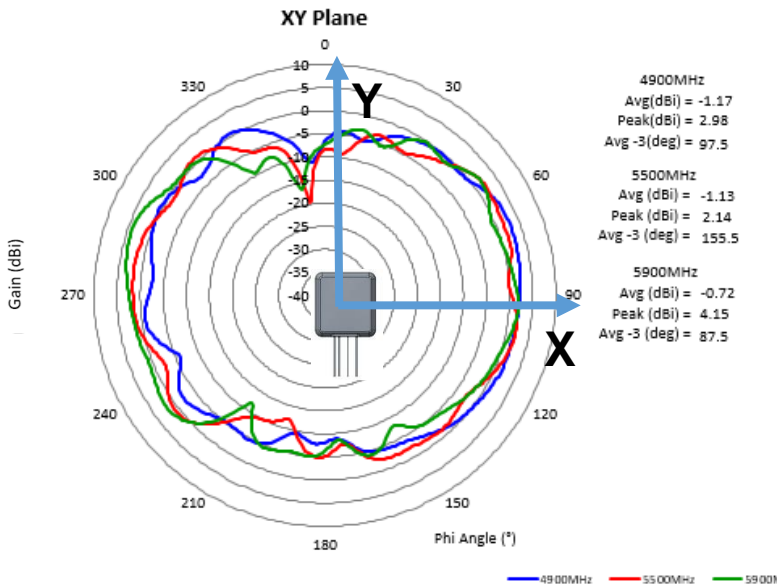

Gain Plots WiFi 1

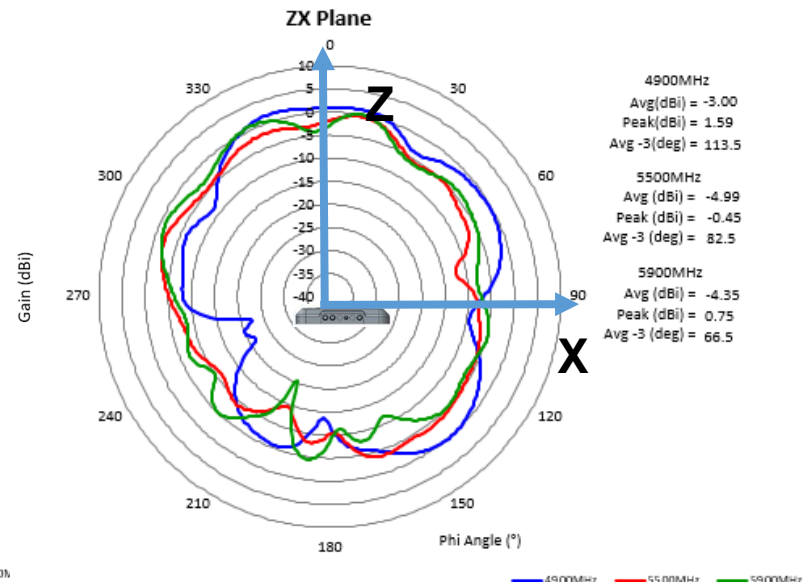

Gain Plots WiFi 1

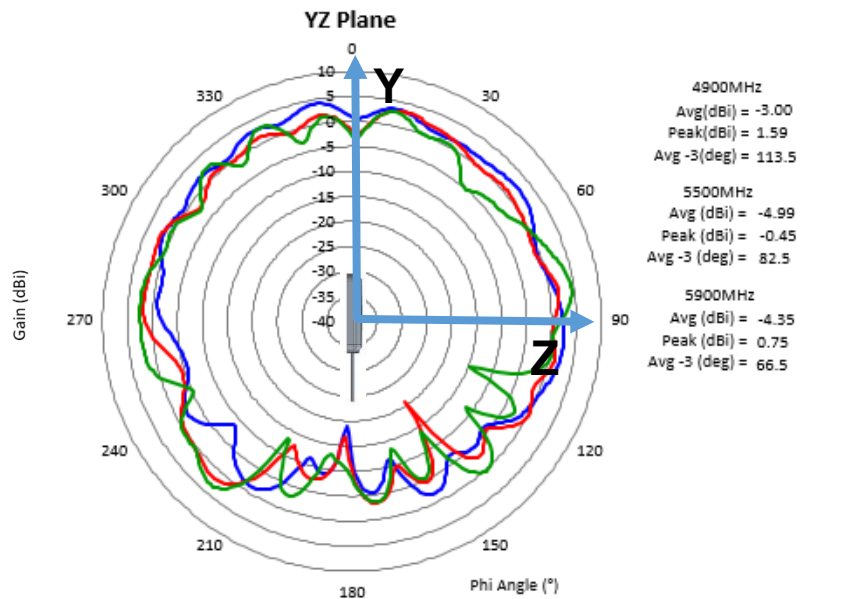

Gain Plots WiFi 1

Issue: 1922

In the effort to improve our products, we reserve the right to make changes judged to be necessary.

CONFIDENTIAL AND PROPRIETARY INFORMATION

This document contains confidential and proprietary information of Pulse Electronics, Inc. (Pulse) and is protected by copyright, trade secret and other state and federal laws. Its receipt or possession does not convey any rights to reproduce, disclose its contents, or to manufacture, use or sell anything it may describe. Reproduction, disclosure or use without specific written authorization of Pulse is strictly forbidden.

Description: 2X LTE, 2XWiFi Vehicular Antenna

Series: Low Profile MB

PART NUMBER: LPMB40X

CHARTS

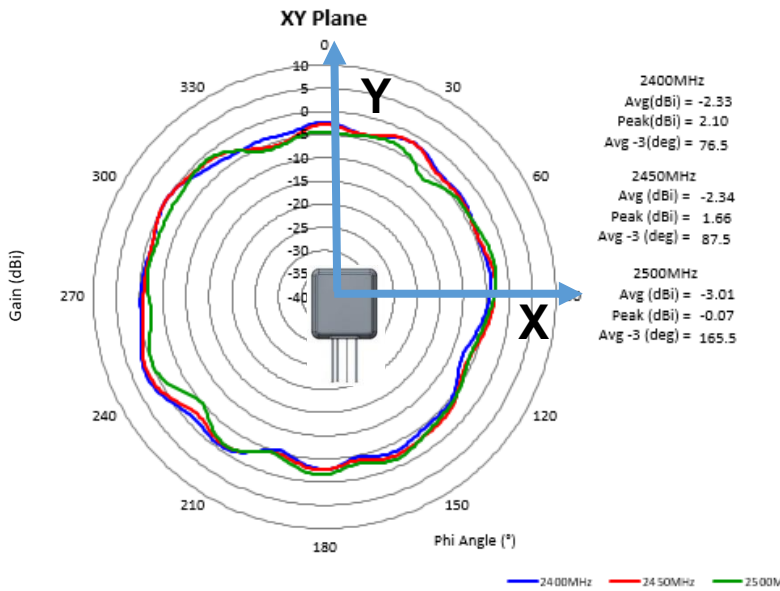

Gain Plots WiFi 2

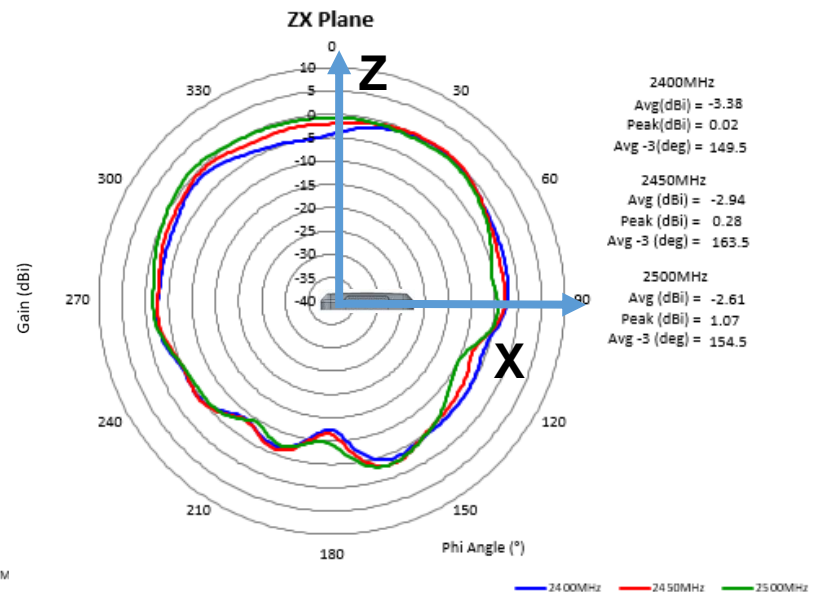

Gain Plots WiFi 2

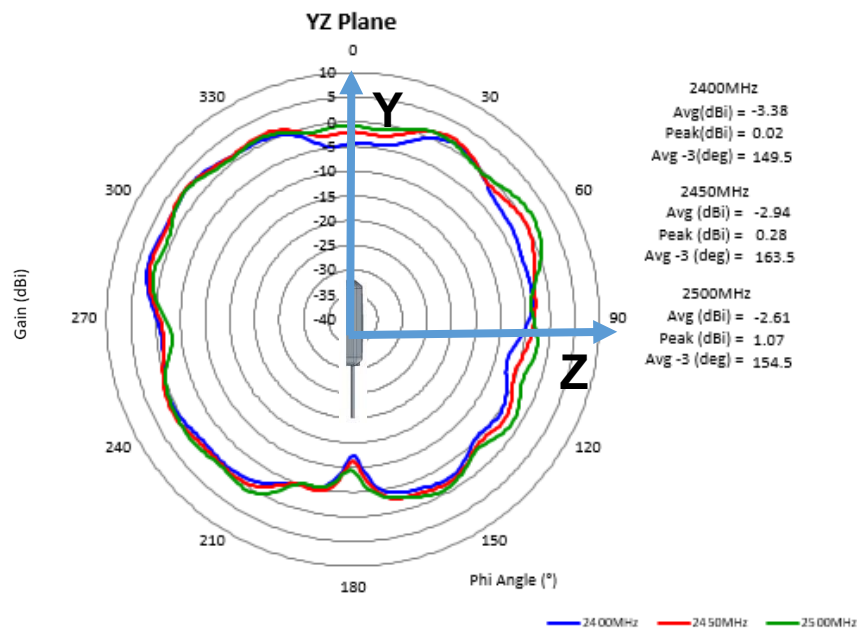

Gain Plots WiFi 2

Issue: 1922

In the effort to improve our products, we reserve the right to make changes judged to be necessary.

CONFIDENTIAL AND PROPRIETARY INFORMATION

This document contains confidential and proprietary information of Pulse Electronics, Inc. (Pulse) and is protected by copyright, trade secret and other state and federal laws. Its receipt or possession does not convey any rights to reproduce, disclose its contents, or to manufacture, use or sell anything it may describe. Reproduction, disclosure or use without specific written authorization of Pulse is strictly forbidden.

Description: 2X LTE, 2XWiFi Vehicular Antenna

Series: Low Profile MB

PART NUMBER: LPMB40X

CHARTS

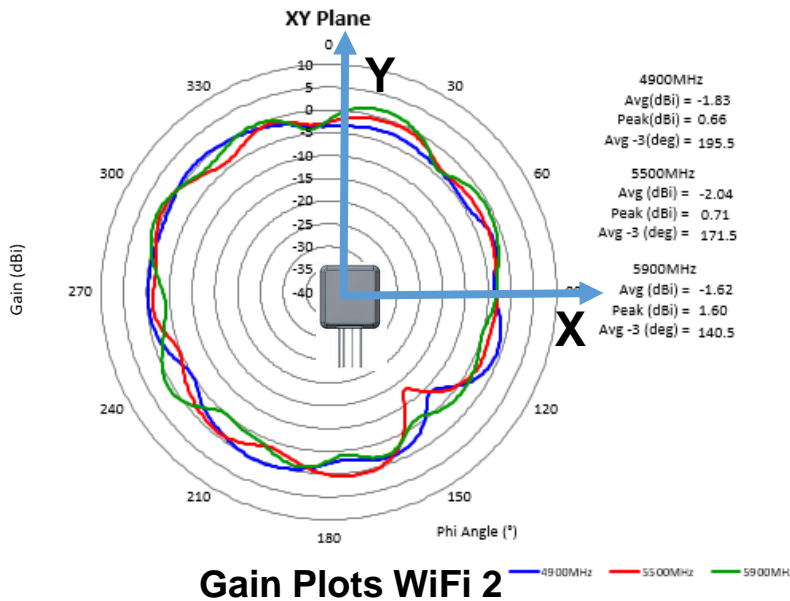

Gain Plots WiFi 2

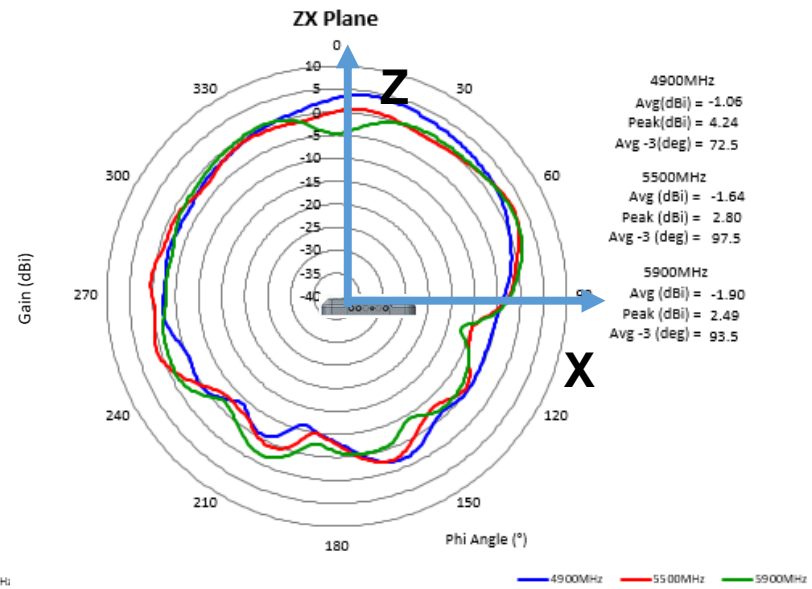

Gain Plots WiFi 2

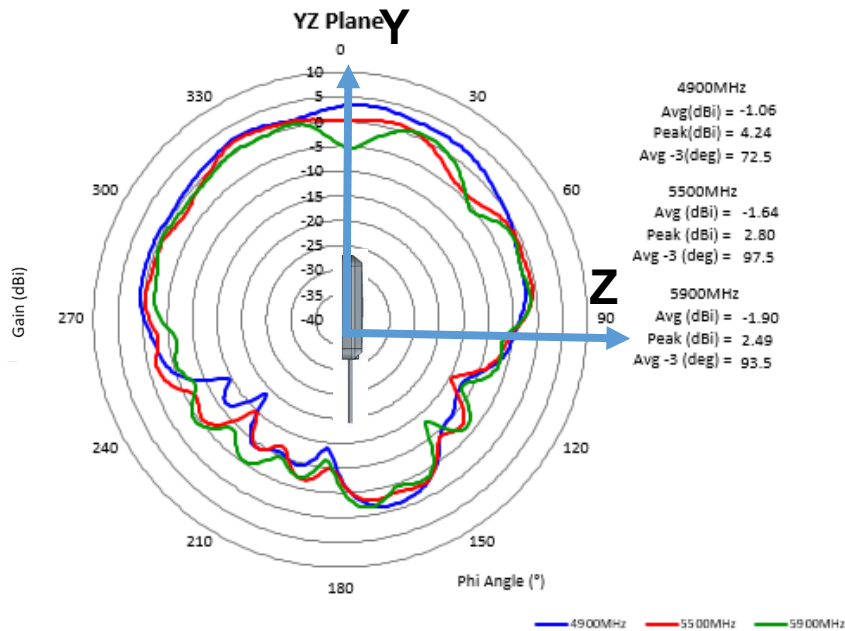

Gain Plots WiFi 2

Issue: 1922

In the effort to improve our products, we reserve the right to make changes judged to be necessary.

CONFIDENTIAL AND PROPRIETARY INFORMATION

This document contains confidential and proprietary information of Pulse Electronics, Inc. (Pulse) and is protected by copyright, trade secret and other state and federal laws. Its receipt or possession does not convey any rights to reproduce, disclose its contents, or to manufacture, use or sell anything it may describe. Reproduction, disclosure or use without specific written authorization of Pulse is strictly forbidden.

Description: 2X LTE, 2XWiFi Vehicular Antenna

Series: Low Profile MB

PART NUMBER: LPMB40X

CHARTS

Situation 2: Performance on 1 inch bracket with ϕ 500mm(19.7inch) ground

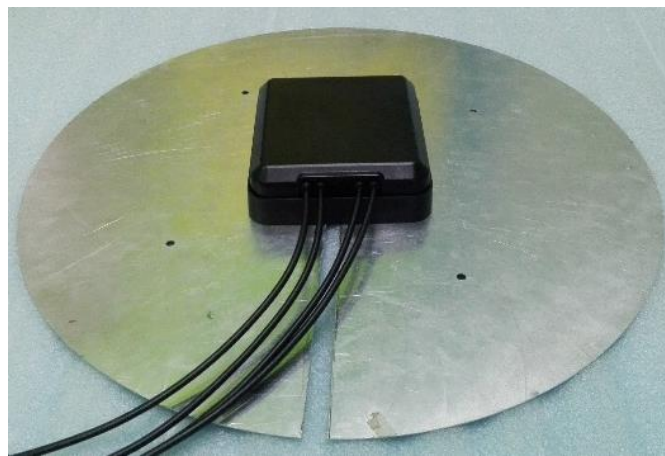

LTE 1 & LTE 2 VSWR

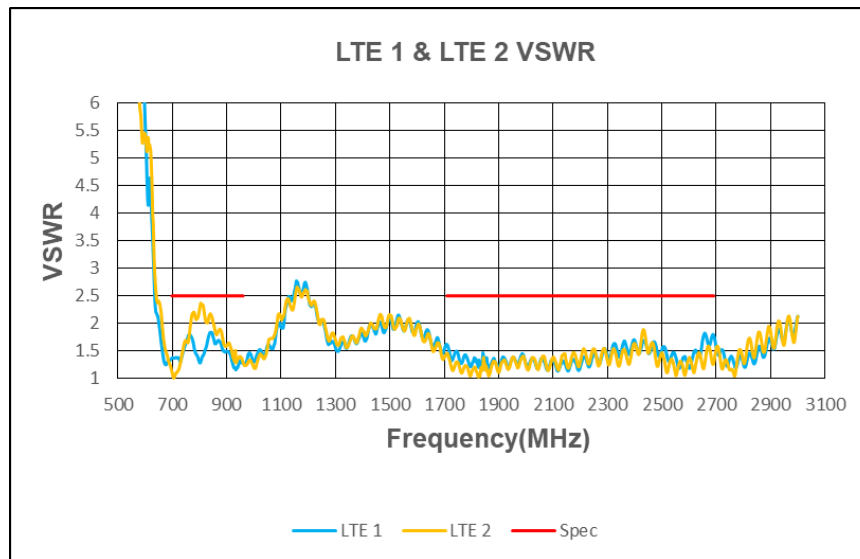

Note : Measured on 500mm ground plane with 3m cable

Issue: 1922

In the effort to improve our products, we reserve the right to make changes judged to be necessary.

CONFIDENTIAL AND PROPRIETARY INFORMATION

This document contains confidential and proprietary information of Pulse Electronics, Inc. (Pulse) and is protected by copyright, trade secret and other state and federal laws. Its receipt or possession does not convey any rights to reproduce, disclose its contents, or to manufacture, use or sell anything it may describe. Reproduction, disclosure or use without specific written authorization of Pulse is strictly forbidden.

Description: 2X LTE, 2XWiFi Vehicular Antenna

Series: Low Profile MB

PART NUMBER: LPMB40X

CHARTS

WiFi 1 & WiFi 2 VSWR

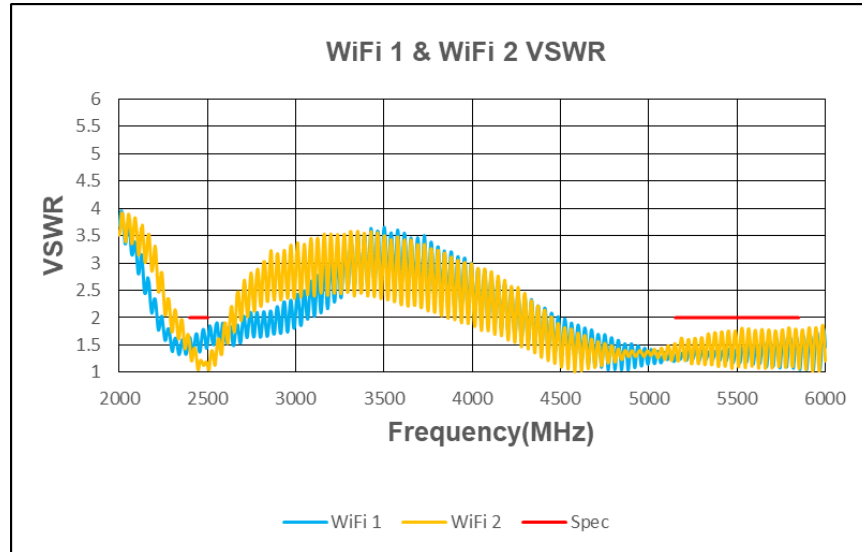

Isolation

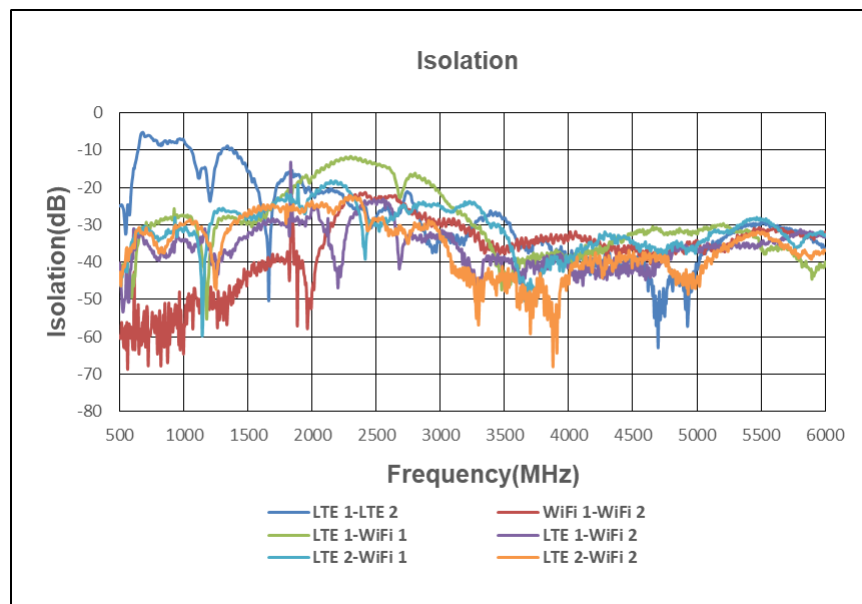

Note : Measured on 500mm ground plane with 3m cable

Issue: 1922

In the effort to improve our products, we reserve the right to make changes judged to be necessary.

CONFIDENTIAL AND PROPRIETARY INFORMATION

This document contains confidential and proprietary information of Pulse Electronics, Inc. (Pulse) and is protected by copyright, trade secret and other state and federal laws. Its receipt or possession does not convey any rights to reproduce, disclose its contents, or to manufacture, use or sell anything it may describe. Reproduction, disclosure or use without specific written authorization of Pulse is strictly forbidden.

Description: 2X LTE, 2XWiFi Vehicular Antenna

Series: Low Profile MB

PART NUMBER: LPMB40X

CHARTS

LTE 1 and LTE2 Efficiency

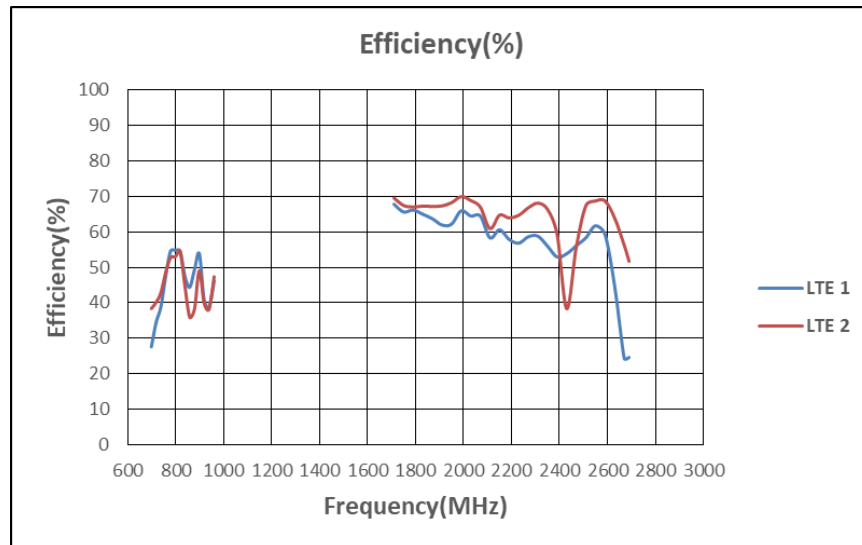

WiFi 1 and WiFi 2 Efficiency

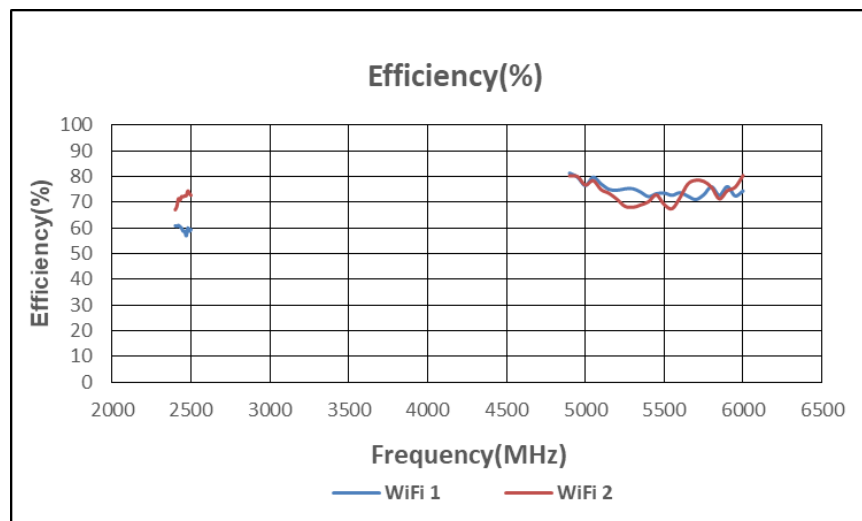

Note :Measured on 500mm ground plane with 322mm cable

Issue: 1922

In the effort to improve our products, we reserve the right to make changes judged to be necessary.

CONFIDENTIAL AND PROPRIETARY INFORMATION

This document contains confidential and proprietary information of Pulse Electronics, Inc. (Pulse) and is protected by copyright, trade secret and other state and federal laws. Its receipt or possession does not convey any rights to reproduce, disclose its contents, or to manufacture, use or sell anything it may describe. Reproduction, disclosure or use without specific written authorization of Pulse is strictly forbidden.

Description: 2X LTE, 2XWiFi Vehicular Antenna

Series: Low Profile MB

PART NUMBER: LPMB40X

CHARTS

LTE 1 and LTE2 Peak Gain

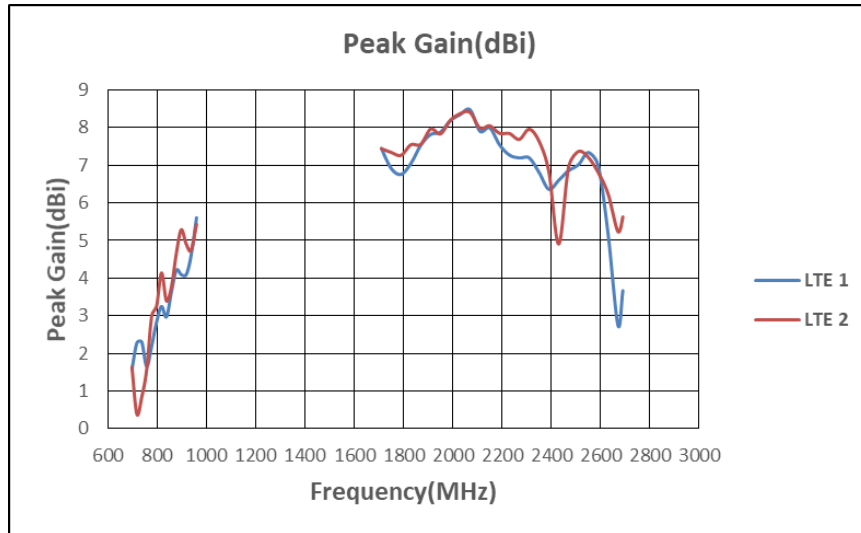

WiFi 1 and WiFi 2 Peak Gain

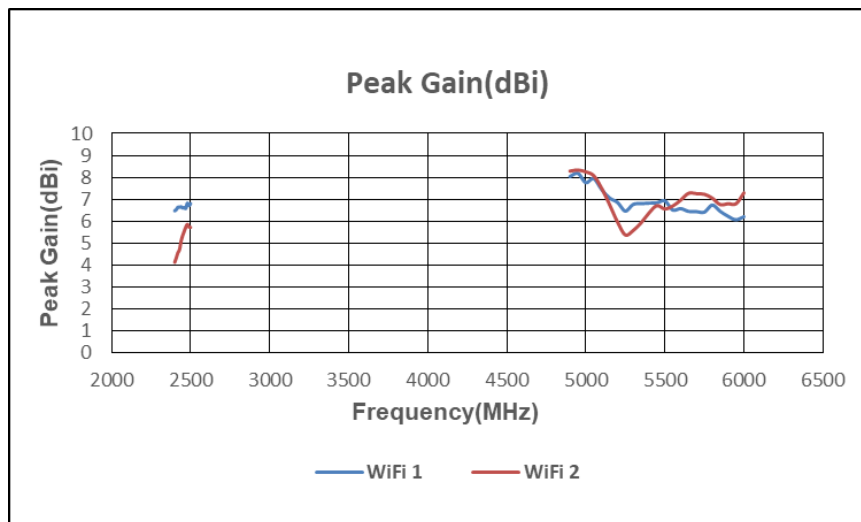

Note :Measured on 500mm ground plane with 322mm cable

Issue: 1922

In the effort to improve our products, we reserve the right to make changes judged to be necessary.

CONFIDENTIAL AND PROPRIETARY INFORMATION

This document contains confidential and proprietary information of Pulse Electronics, Inc. (Pulse) and is protected by copyright, trade secret and other state and federal laws. Its receipt or possession does not convey any rights to reproduce, disclose its contents, or to manufacture, use or sell anything it may describe. Reproduction, disclosure or use without specific written authorization of Pulse is strictly forbidden.

Description: 2X LTE, 2XWiFi Vehicular Antenna

Series: Low Profile MB

PART NUMBER: LPMB40X

CHARTS

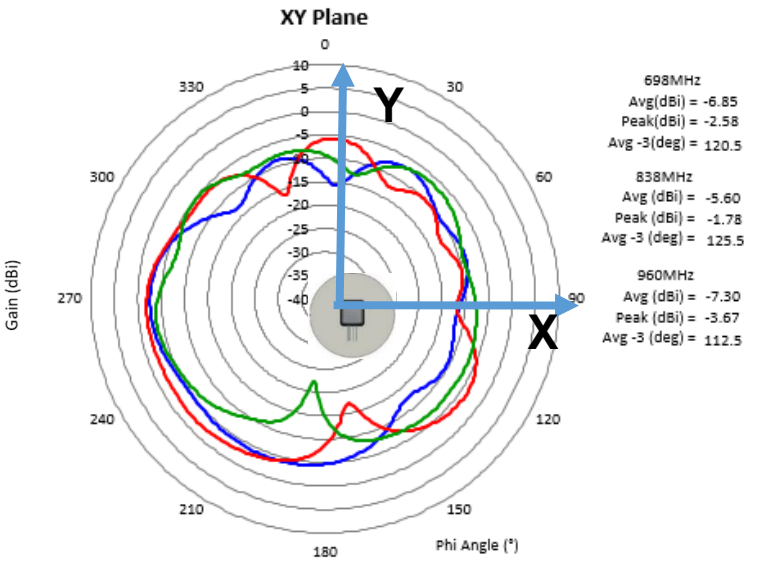

Gain Plots LTE 1

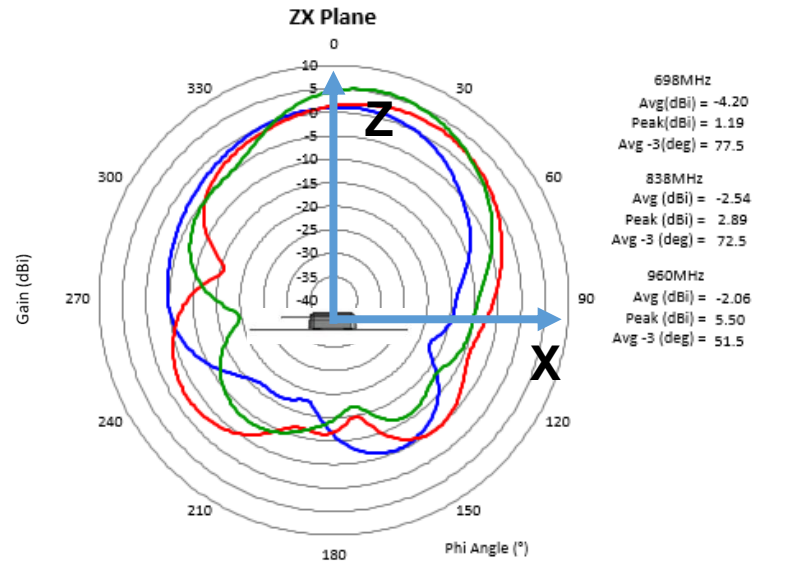

Gain Plots LTE 1

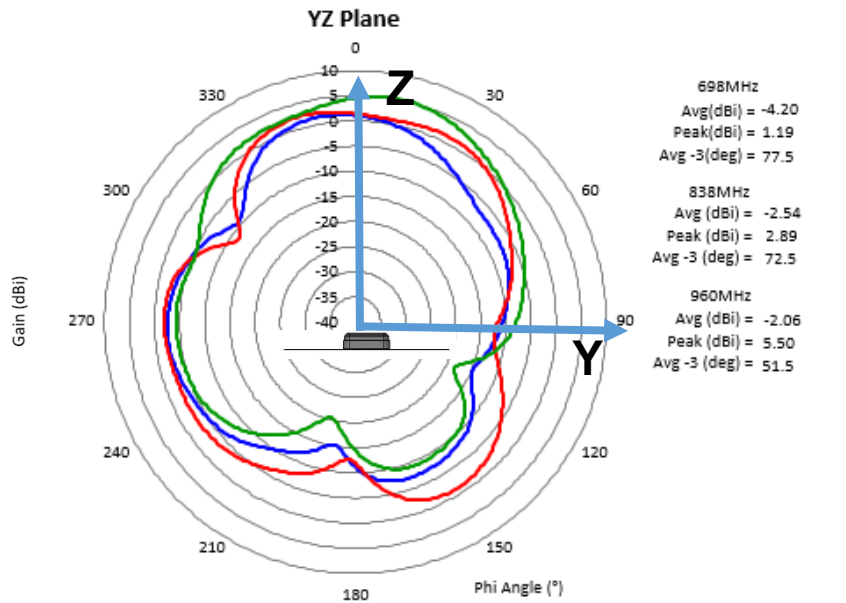

Gain Plots LTE 1

Issue: 1922

In the effort to improve our products, we reserve the right to make changes judged to be necessary.

CONFIDENTIAL AND PROPRIETARY INFORMATION

This document contains confidential and proprietary information of Pulse Electronics, Inc. (Pulse) and is protected by copyright, trade secret and other state and federal laws. Its receipt or possession does not convey any rights to reproduce, disclose its contents, or to manufacture, use or sell anything it may describe. Reproduction, disclosure or use without specific written authorization of Pulse is strictly forbidden.

Description: 2X LTE, 2XWiFi Vehicular Antenna

Series: Low Profile MB

PART NUMBER: LPMB40X

CHARTS

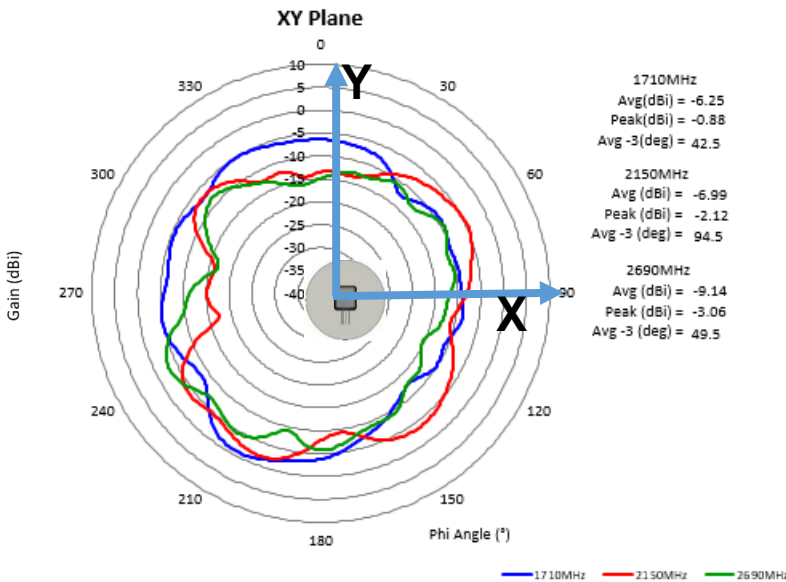

Gain Plots LTE 1

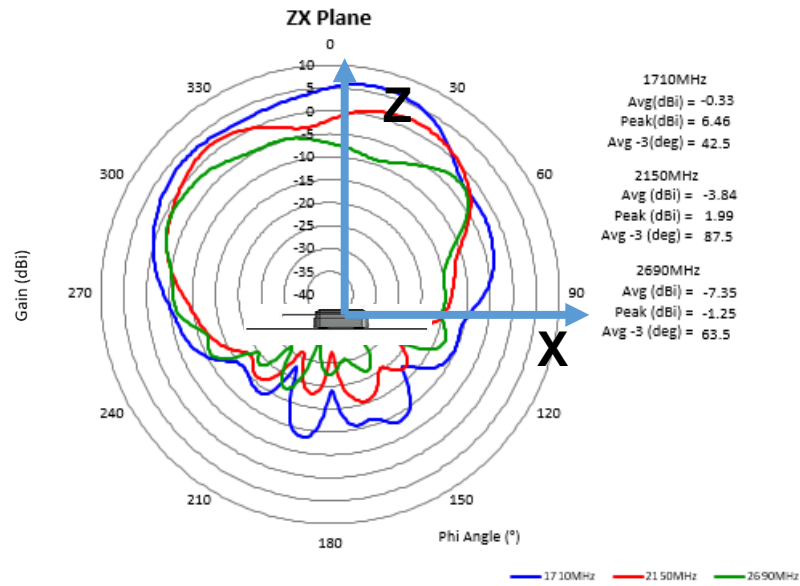

Gain Plots LTE 1

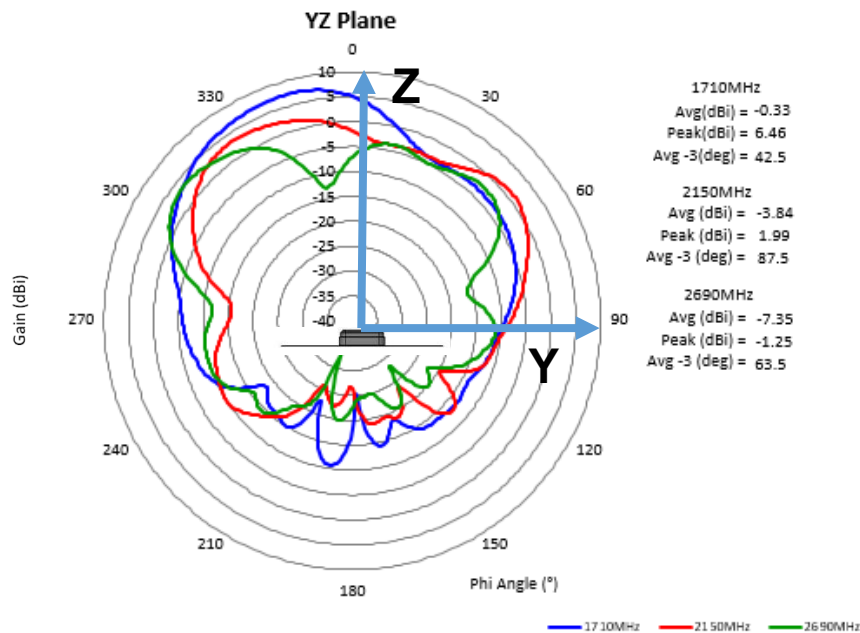

Gain Plots LTE 1

Issue: 1922

In the effort to improve our products, we reserve the right to make changes judged to be necessary.

CONFIDENTIAL AND PROPRIETARY INFORMATION

This document contains confidential and proprietary information of Pulse Electronics, Inc. (Pulse) and is protected by copyright, trade secret and other state and federal laws. Its receipt or possession does not convey any rights to reproduce, disclose its contents, or to manufacture, use or sell anything it may describe. Reproduction, disclosure or use without specific written authorization of Pulse is strictly forbidden.

Description: 2X LTE, 2XWiFi Vehicular Antenna

Series: Low Profile MB

PART NUMBER: LPMB40X

CHARTS

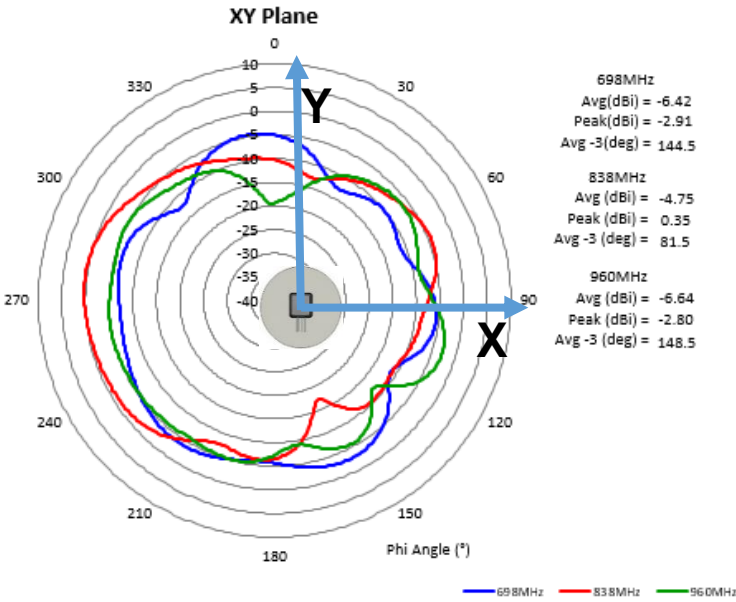

Gain Plots LTE 2

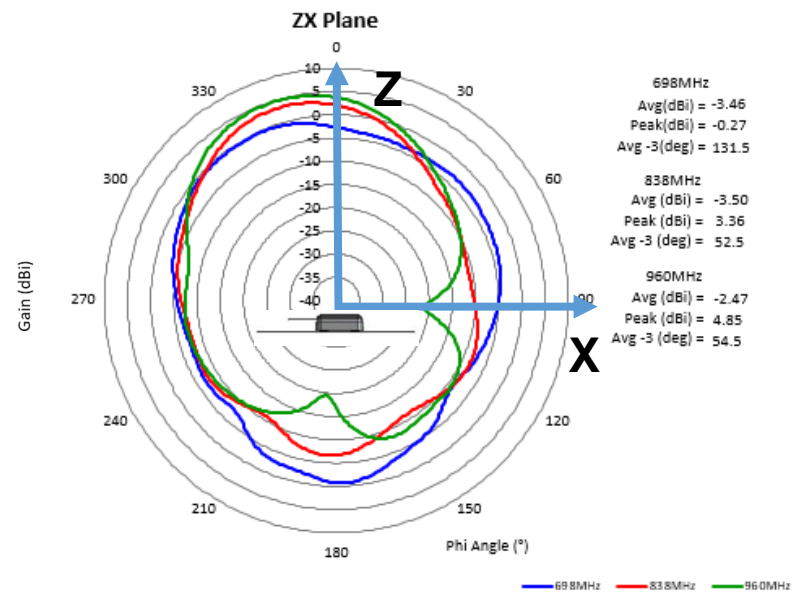

Gain Plots LTE 2

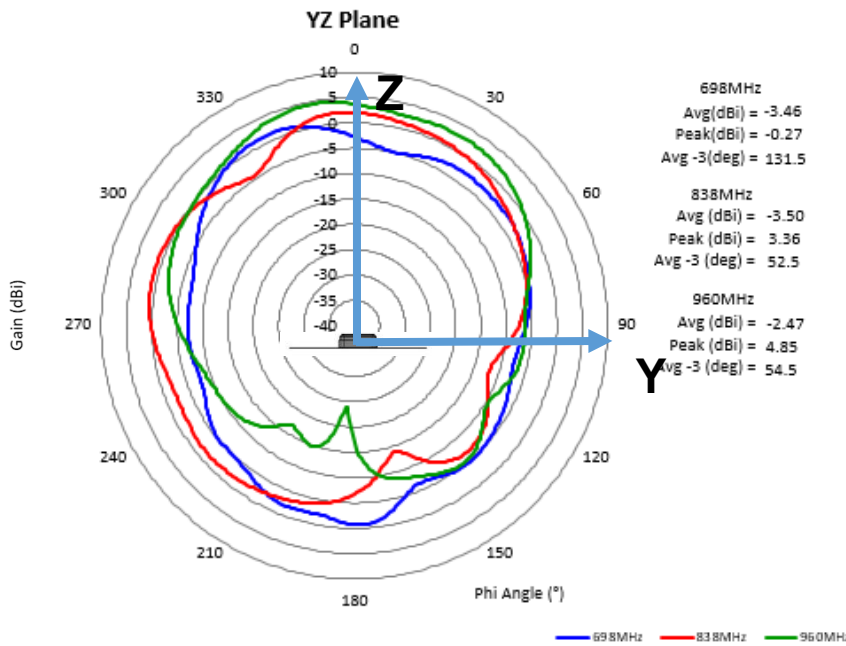

Gain Plots LTE 2

Issue: 1922

In the effort to improve our products, we reserve the right to make changes judged to be necessary.

CONFIDENTIAL AND PROPRIETARY INFORMATION

This document contains confidential and proprietary information of Pulse Electronics, Inc. (Pulse) and is protected by copyright, trade secret and other state and federal laws. Its receipt or possession does not convey any rights to reproduce, disclose its contents, or to manufacture, use or sell anything it may describe. Reproduction, disclosure or use without specific written authorization of Pulse is strictly forbidden.

Description: 2X LTE, 2XWiFi Vehicular Antenna

Series: Low Profile MB

PART NUMBER: LPMB40X

CHARTS

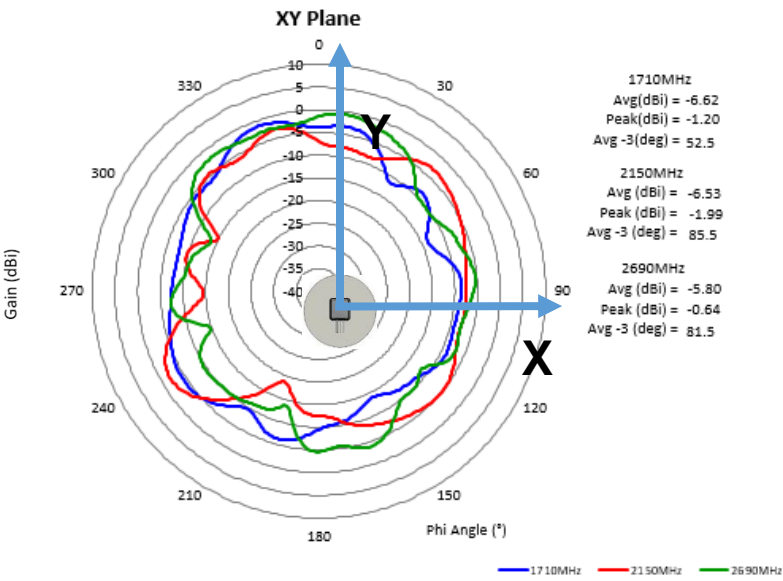

Gain Plots LTE 2

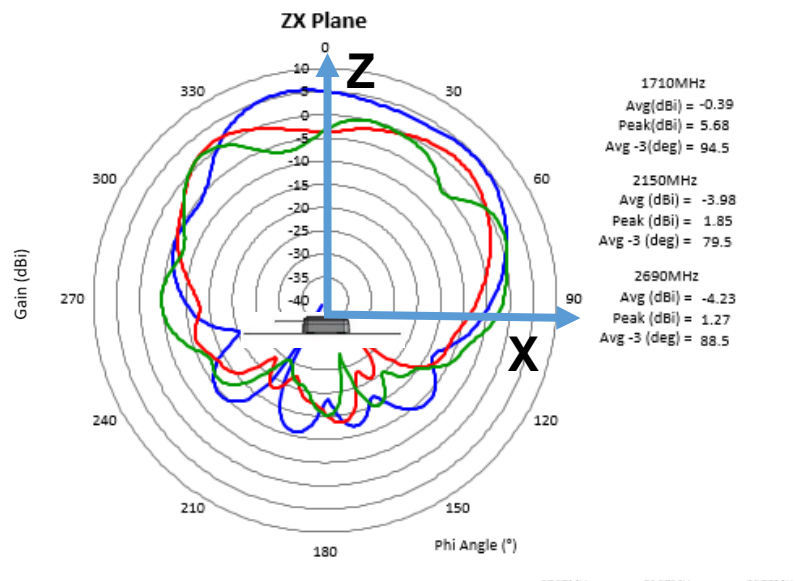

Gain Plots LTE 2

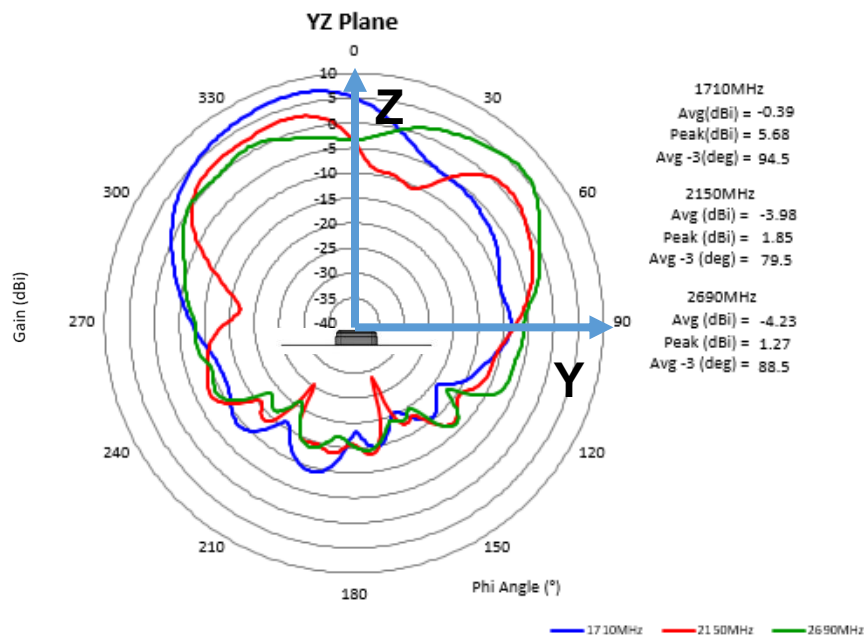

Gain Plots LTE 2

Issue: 1922

In the effort to improve our products, we reserve the right to make changes judged to be necessary.

CONFIDENTIAL AND PROPRIETARY INFORMATION

This document contains confidential and proprietary information of Pulse Electronics, Inc. (Pulse) and is protected by copyright, trade secret and other state and federal laws. Its receipt or possession does not convey any rights to reproduce, disclose its contents, or to manufacture, use or sell anything it may describe. Reproduction, disclosure or use without specific written authorization of Pulse is strictly forbidden.

Description: 2X LTE, 2XWiFi Vehicular Antenna

Series: Low Profile MB

PART NUMBER: LPMB40X

CHARTS

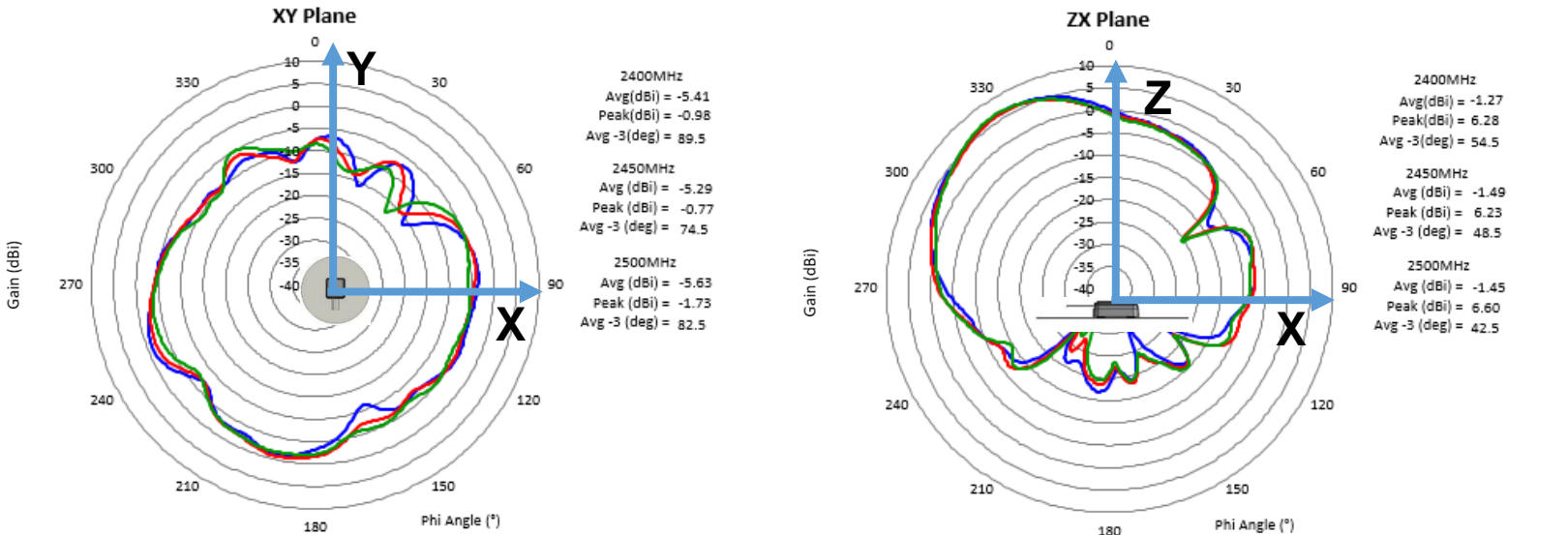

Gain Plots WiFi 1

Gain Plots WiFi 1

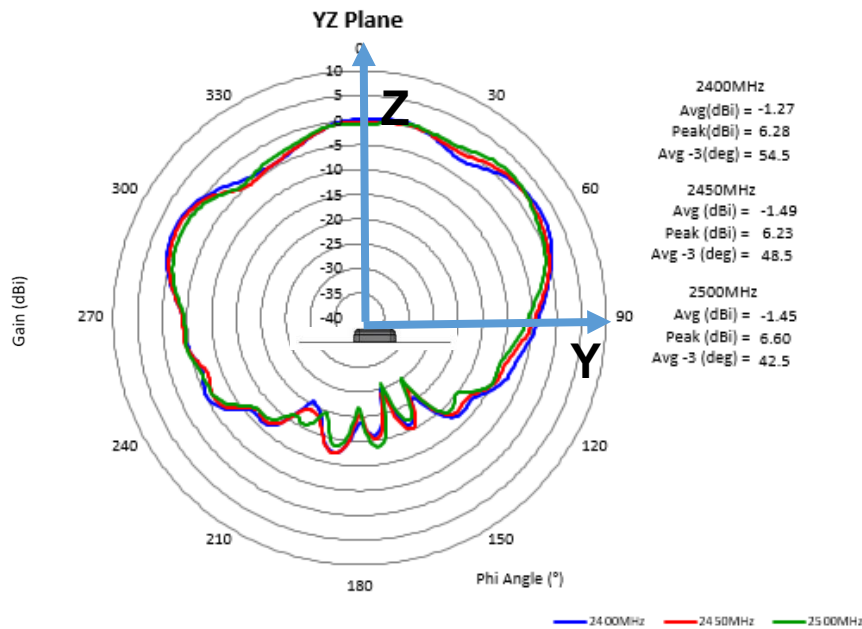

Gain Plots WiFi 1

Issue: 1922

In the effort to improve our products, we reserve the right to make changes judged to be necessary.
CONFIDENTIAL AND PROPRIETARY INFORMATION

This document contains confidential and proprietary information of Pulse Electronics, Inc. (Pulse) and is protected by copyright, trade secret and other state and federal laws. Its receipt or possession does not convey any rights to reproduce, disclose its contents, or to manufacture, use or sell anything it may describe. Reproduction, disclosure or use without specific written authorization of Pulse is strictly forbidden.

Description: 2X LTE, 2XWiFi Vehicular Antenna

Series: Low Profile MB

PART NUMBER: LPMB40X

CHARTS

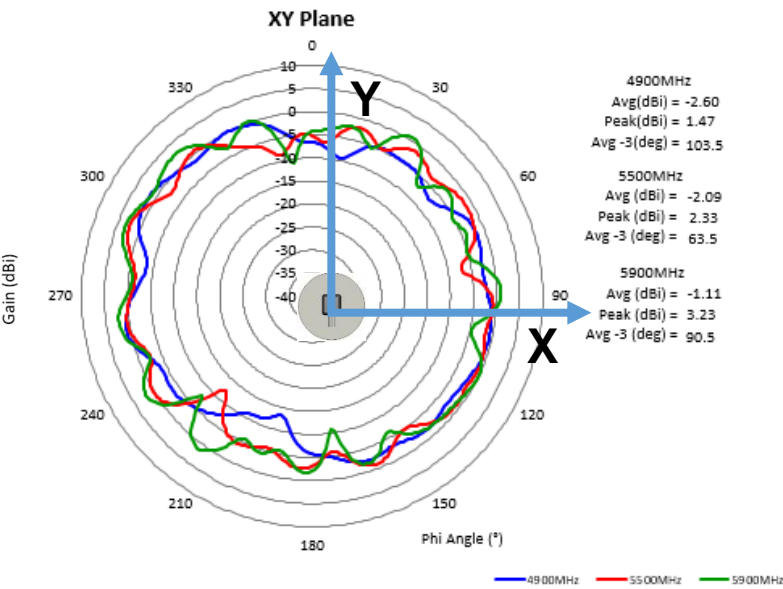

Gain Plots WiFi 1

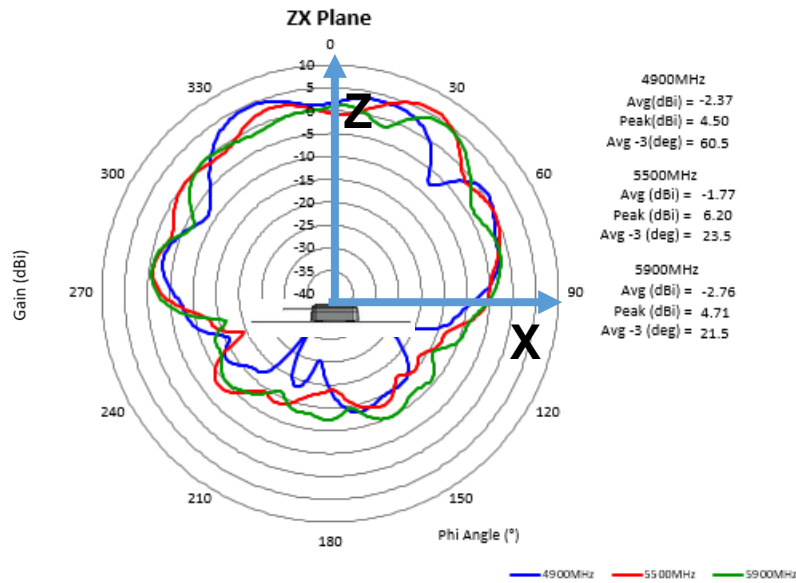

Gain Plots WiFi 1

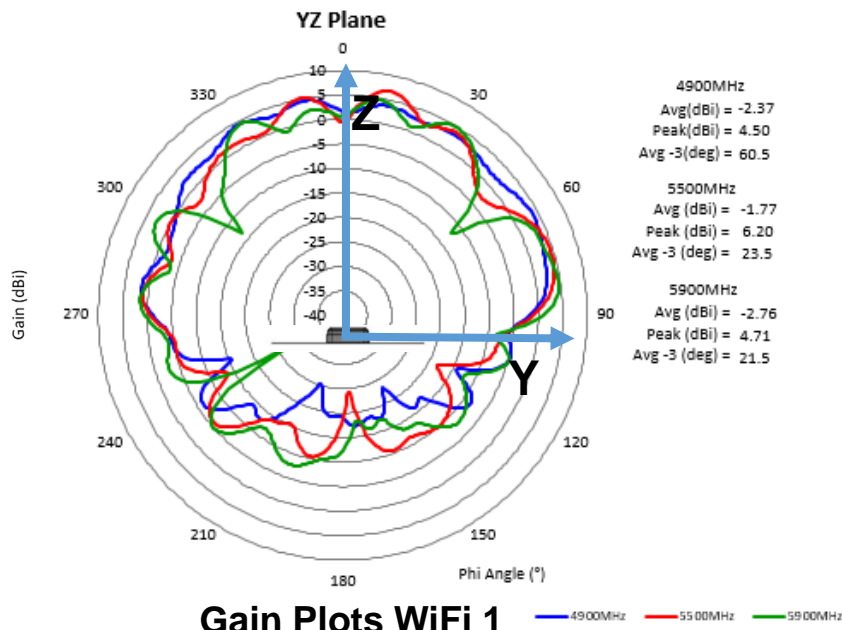

Gain Plots WiFi 1

Issue: 1922

In the effort to improve our products, we reserve the right to make changes judged to be necessary.

CONFIDENTIAL AND PROPRIETARY INFORMATION

This document contains confidential and proprietary information of Pulse Electronics, Inc. (Pulse) and is protected by copyright, trade secret and other state and federal laws. Its receipt or possession does not convey any rights to reproduce, disclose its contents, or to manufacture, use or sell anything it may describe. Reproduction, disclosure or use without specific written authorization of Pulse is strictly forbidden.

Description: 2X LTE, 2XWiFi Vehicular Antenna

Series: Low Profile MB

PART NUMBER: LPMB40X

CHARTS

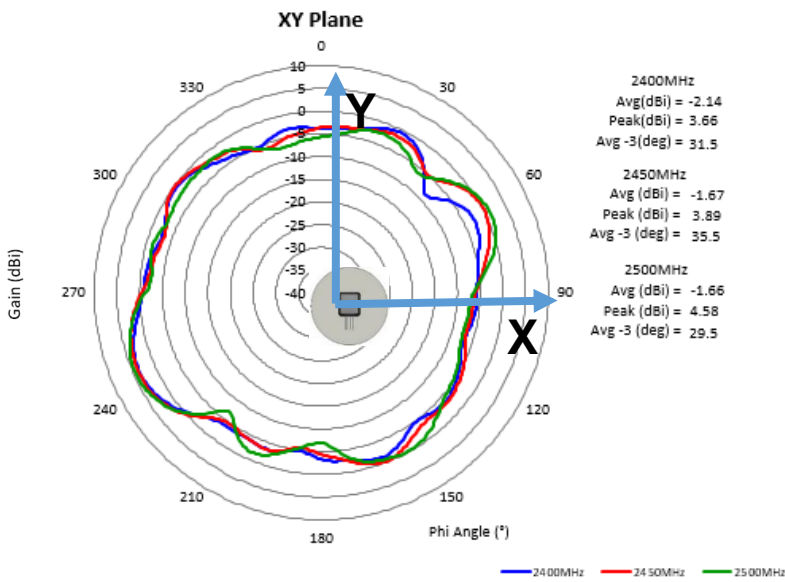

Gain Plots WiFi 2

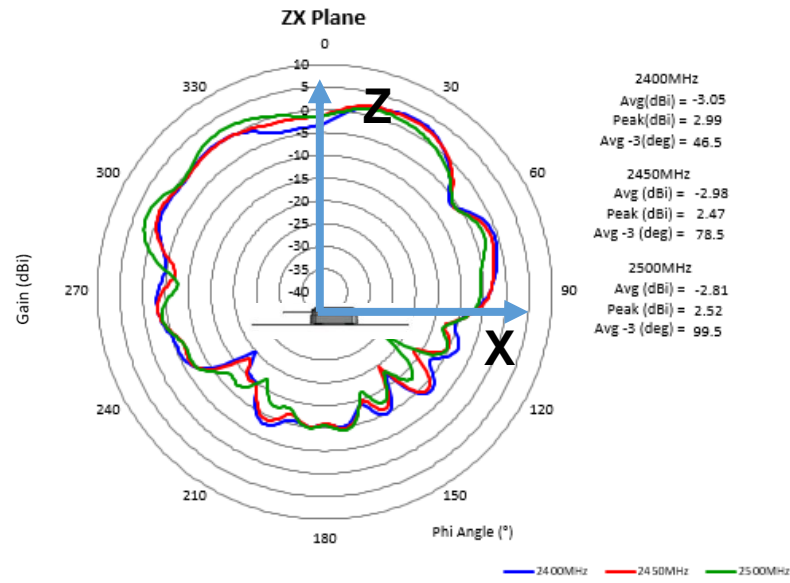

Gain Plots WiFi 2

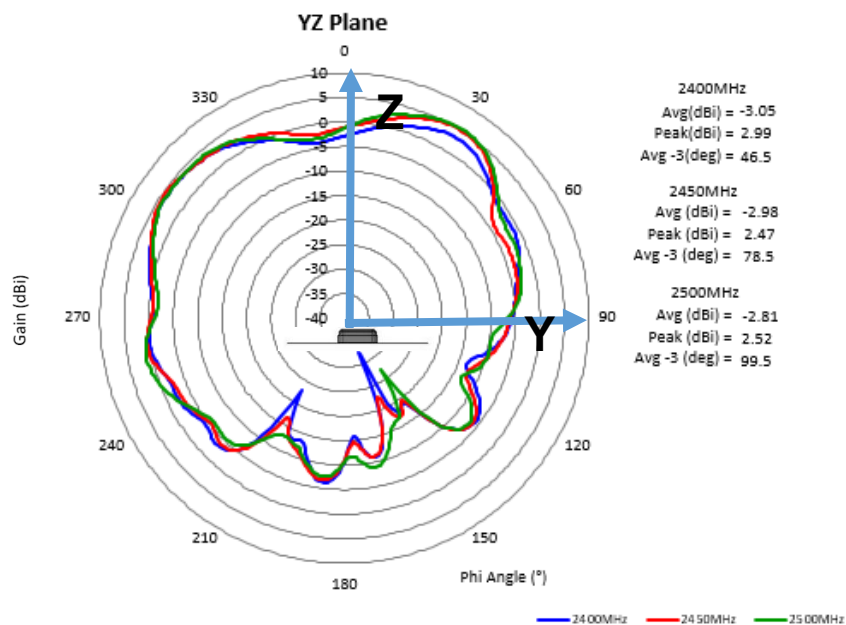

Gain Plots WiFi 2

Issue: 1922

In the effort to improve our products, we reserve the right to make changes judged to be necessary.

CONFIDENTIAL AND PROPRIETARY INFORMATION

This document contains confidential and proprietary information of Pulse Electronics, Inc. (Pulse) and is protected by copyright, trade secret and other state and federal laws. Its receipt or possession does not convey any rights to reproduce, disclose its contents, or to manufacture, use or sell anything it may describe. Reproduction, disclosure or use without specific written authorization of Pulse is strictly forbidden.

Description: 2X LTE, 2XWiFi Vehicular Antenna

Series: Low Profile MB

PART NUMBER: LPMB40X

CHARTS

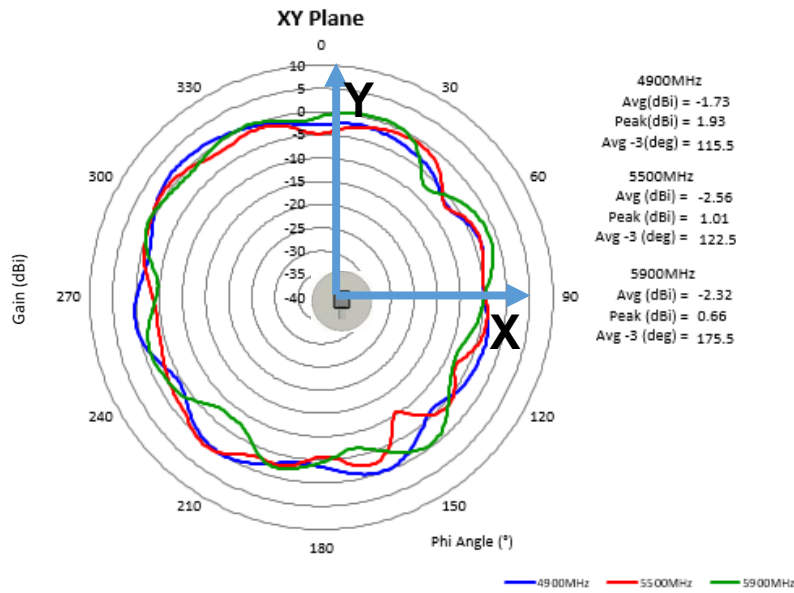

Gain Plots WiFi 2

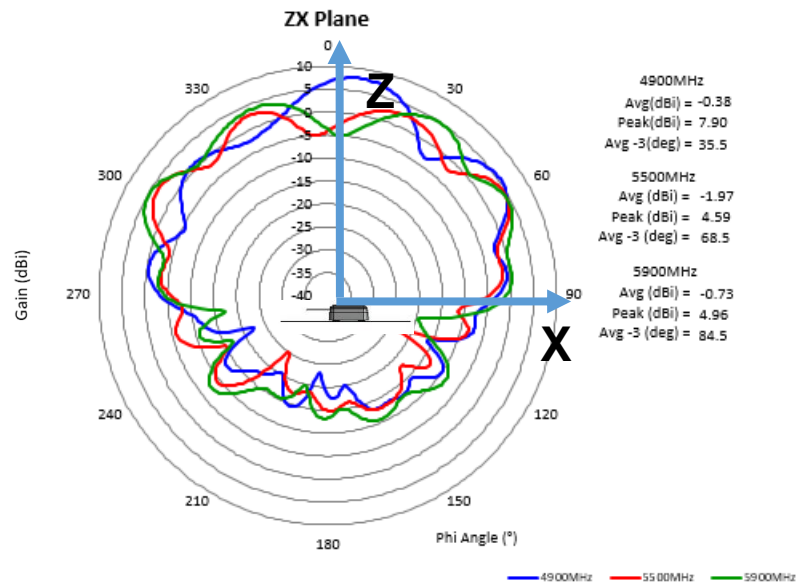

Gain Plots WiFi 2

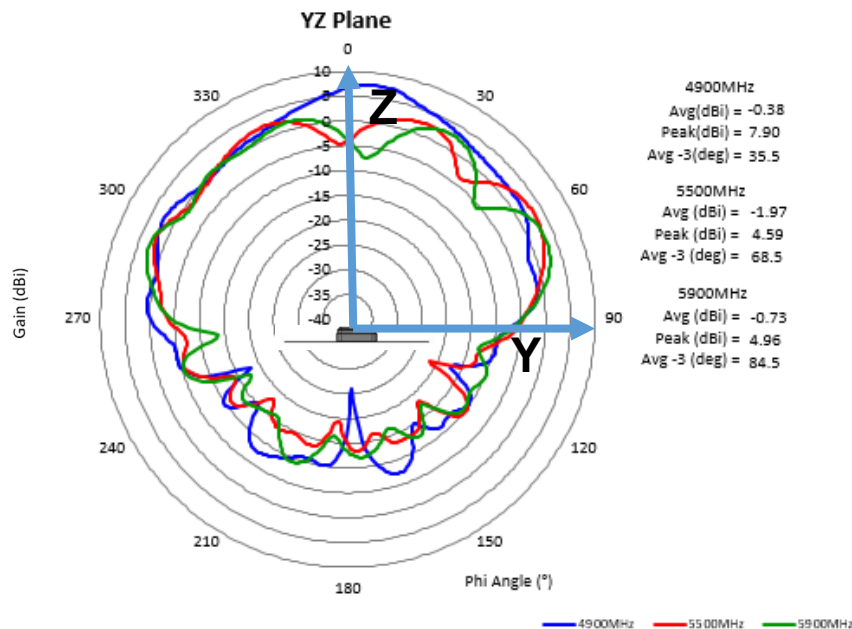

Gain Plots WiFi 2

Issue: 1922

In the effort to improve our products, we reserve the right to make changes judged to be necessary.

CONFIDENTIAL AND PROPRIETARY INFORMATION

This document contains confidential and proprietary information of Pulse Electronics, Inc. (Pulse) and is protected by copyright, trade secret and other state and federal laws. Its receipt or possession does not convey any rights to reproduce, disclose its contents, or to manufacture, use or sell anything it may describe. Reproduction, disclosure or use without specific written authorization of Pulse is strictly forbidden.

Description: 2X LTE, 2XWiFi Vehicular Antenna

Series: Low Profile MB

PART NUMBER: LPMB40X

PACKAGING

- Each antenna packed in a plastic bag
- 18 bags(TBD) of antennas packed in a cardboard box.
- 1 label on each box with qty, part number, date code.

ASSEMBLY

Option 1, Apply to the surface of the glass fiber or plastic material, the antenna could be adhered on the surface directly.

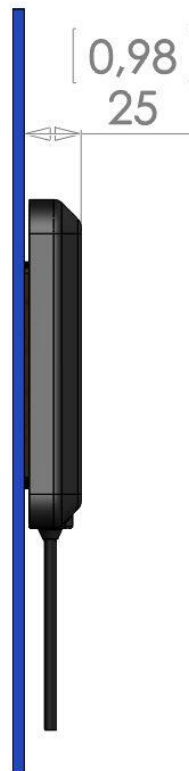

Description: 2X LTE, 2XWiFi Vehicular Antenna

Series: Low Profile MB

PART NUMBER: LPMB40X

ASSEMBLY

Option 2, Apply to the surface of the Iron metals like normal steel/iron, a bracket(GPSLPMM) is needed to elevate the antenna 1" for the optimum RF performance

Firstly, The antenna adhered on a magnetic bracket by the adhesive tape, then the whole assemble could "stick" on the magnetic metals by magnets, and also could be removed from the metals easily.

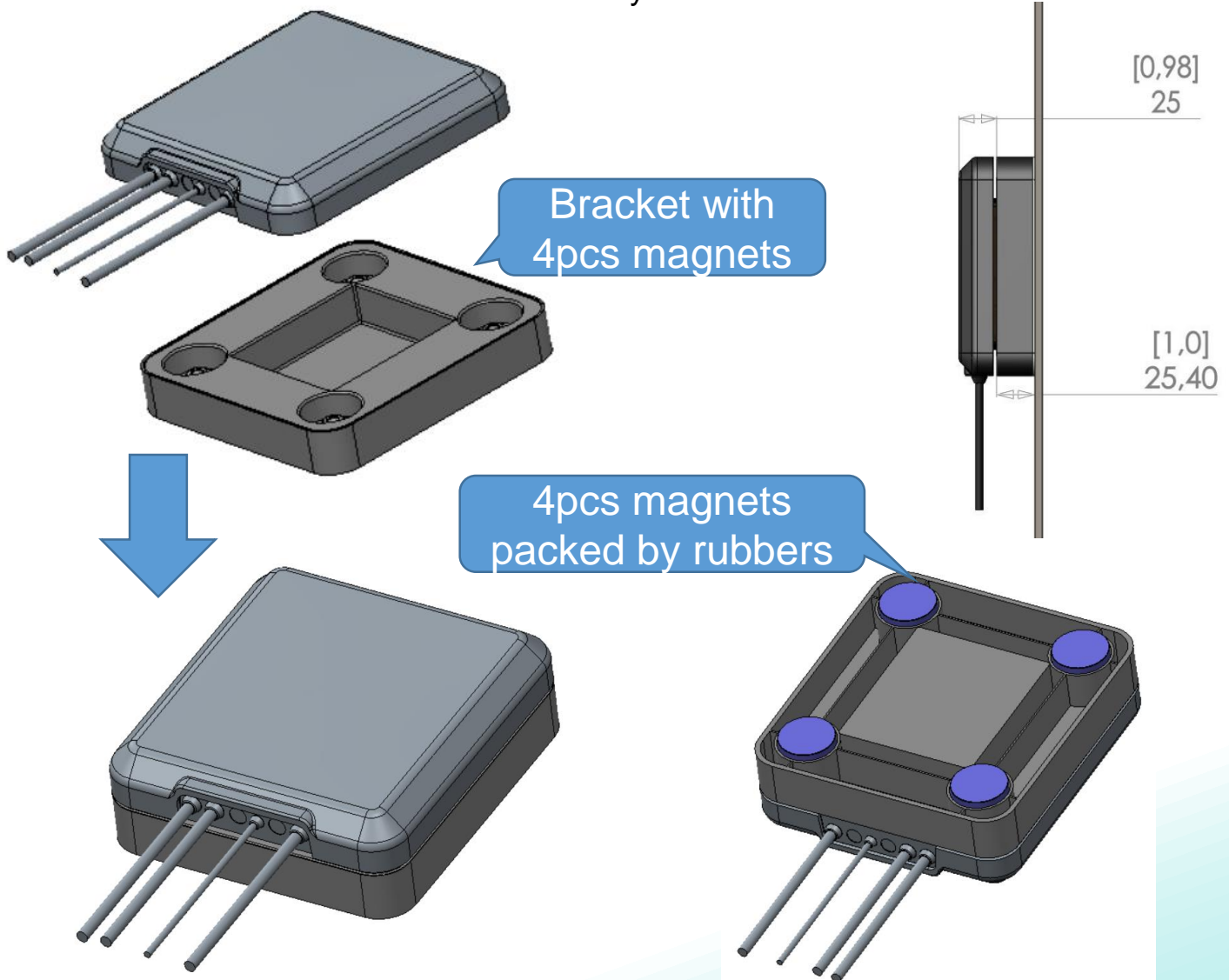

Issue: 1922

In the effort to improve our products, we reserve the right to make changes judged to be necessary.

CONFIDENTIAL AND PROPRIETARY INFORMATION

This document contains confidential and proprietary information of Pulse Electronics, Inc. (Pulse) and is protected by copyright, trade secret and other state and federal laws. Its receipt or possession does not convey any rights to reproduce, disclose its contents, or to manufacture, use or sell anything it may describe. Reproduction, disclosure or use without specific written authorization of Pulse is strictly forbidden.

Description: 2X LTE, 2XWiFi Vehicular Antenna

Series: Low Profile MB

PART NUMBER: LPMB40X

ASSEMBLY

Option 3, Apply to the surface of the non-iron metals like aluminum, a bracket(GPSLPAM) is needed to elevate the antenna 1" for the optimum RF performance

Firstly, the antenna adhered on a bracket by the adhesive tape, then the whole assemble could adhere on the aluminum by the 3MVHB adhesive tape on the bracket.

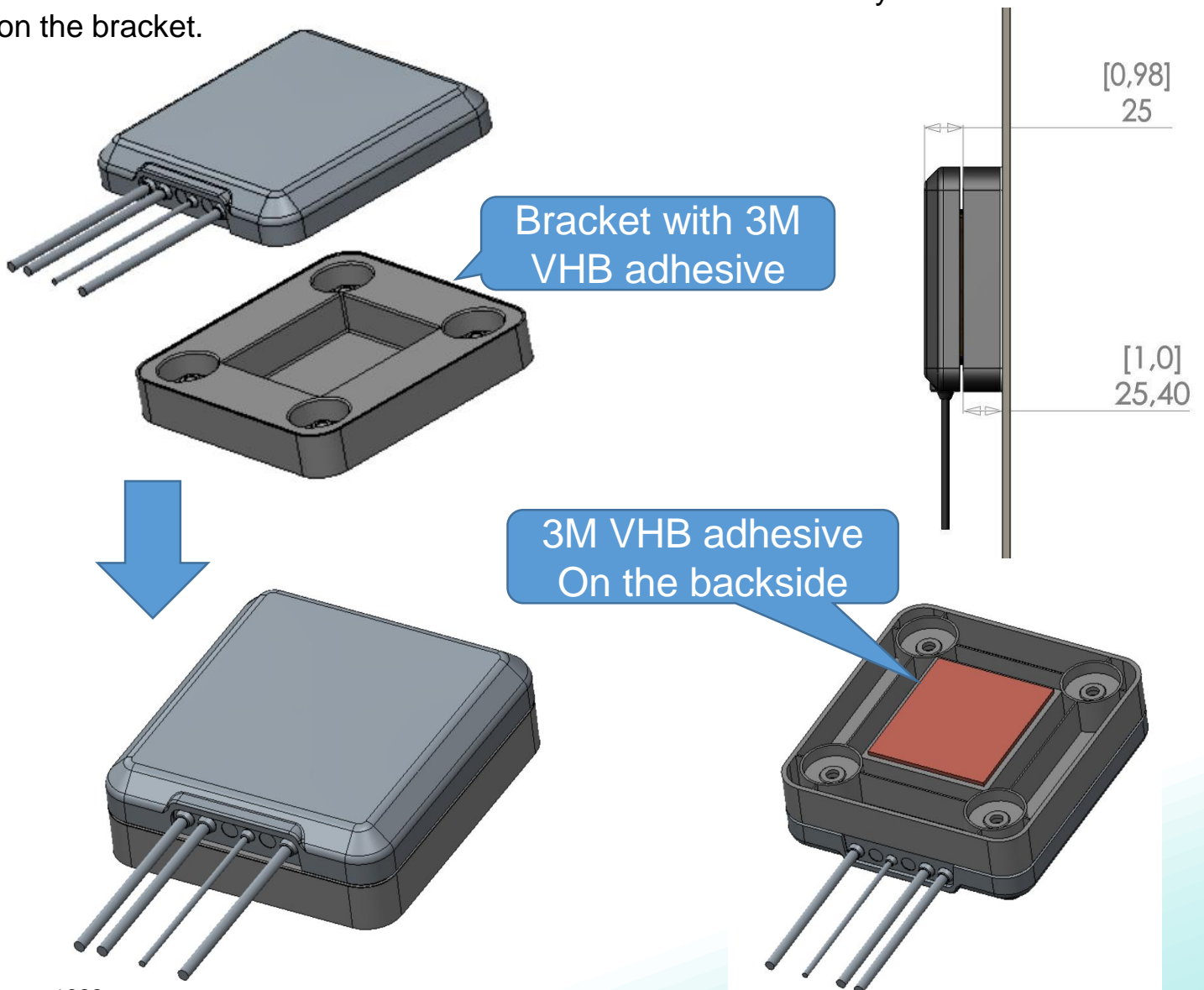

Issue: 1922

In the effort to improve our products, we reserve the right to make changes judged to be necessary.
CONFIDENTIAL AND PROPRIETARY INFORMATION

This document contains confidential and proprietary information of Pulse Electronics, Inc. (Pulse) and is protected by copyright, trade secret and other state and federal laws. Its receipt or possession does not convey any rights to reproduce, disclose its contents, or to manufacture, use or sell anything it may describe. Reproduction, disclosure or use without specific written authorization of Pulse is strictly forbidden.

单击下面可查看定价，库存，交付和生命周期等信息

[>>Pulse\(普思\)](#)