

NOTES:

1. ROHS COMPLIANT
2. HEADER: PHENOLIC WITH FLAMMABILITY RATING UL 94V-0 OR BETTER.
3. STORAGE TEMPERATURE: -20°C TO +125°C
4. COMPLIANCE TO J-STD:
 - A. J-STD-002: SOLDERABILITY AT 245°C REFLOW PROFILE
 - B. J-STD-020: LEVEL 1, NO MOISTURE SENSITIVE
 - C. J-STD-075: R7, 245°C MAXIMUM THROUGH REFLOW SOLDER
5. TO ORDER TAPE & REEL PACKAGING ADD A "T" SUFFIX TO THE PART NUMBER(i.e 23Z467SMFNL BECOMES 23Z467SMFNLT).

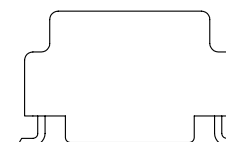
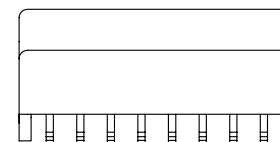
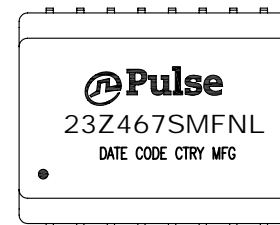

FINAL OUTLINE

© Copyright, 2014. Pulse Electronics Corp. All rights reserved. Pulse confidential & proprietary. (06/11/14)

PRODUCT DESCRIPTION	TLA DRAWING	PS DRAWING	SHEET	PART NO.	DATASHEET REV.
XFMR,SIN,10D,1:2,SM,TU	23Z467SMFNL-11	PS-2755.001-A	1 OF 3	23Z467SMFNL	A

ELECTRICAL CHARACTERISTICS AT +25°C UNLESS OTHER SPECIFIED

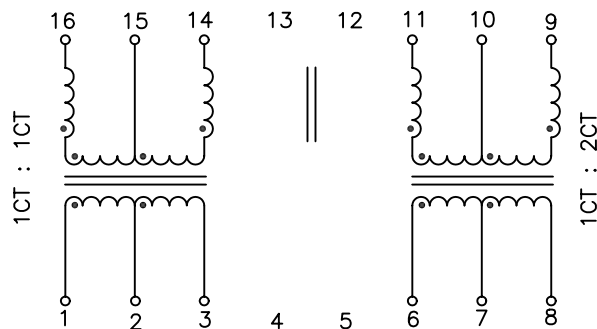

SCHMATIC

PARAMETER	SPECIFICATIONS
OPERATING TEMPERATURE	0°C - 70 °C
POLARITY	PER SCHEMATIC
URNS RATIO (F=10 KHZ)	(1-3) : (16-14) = 1CT : 1CT ±2% (6-8) : (11-9) = 1CT : 2CT ±2% (16-15) : (15-14) = 1:1±2% WITH PINS (1-3) SHORTED (11-10) : (10-9) = 1:1± 2% WITH PINS (6-8) SHORTED
COUPLING CAPACITANCE	(1-3)-(16-14) = 8.0 pF MAX. (6-8)-(11- 9) = 12.0 pF MAX. (V=20mV, F=100 KHz)
LEAKAGE INDUCTANCE	(1-3)-(16-14) = 0.3 uH MAX. (6-8)-(11- 9) = 0.20 uH MAX. (V=20mV, F=100 KHz)
LP (V=20mV, F=10 KHz)	(1-3) = 98 uH MIN. (11- 9) = 70 uH MIN. 15 - (16- 14) = 42 uH MIN.
DCR	(1-3), (16-14) = 0.6 OHM MAX. (6-8), (11-9) = 0.6 OHM MAX. (15-16), (15-14) = 0.3 OHM MAX. (10-11), (10-9) = 0.3 OHM MAX.
BETWEEN CHANNEL ISOLATION	1500 VAC FOR 60 SECONDS

© Copyright, 2014. Pulse Electronics Corp. All rights reserved. Pulse confidential & proprietary. (06/11/14)

PRODUCT DESCRIPTION	TLA DRAWING	PS DRAWING	SHEET	PART NO.	DATASHEET REV.
XFMR,SIN,10D,1:2,SM,TU	23Z467SMFNL-11	PS-2755.001-A	2 OF 3	23Z467SMFNL	A

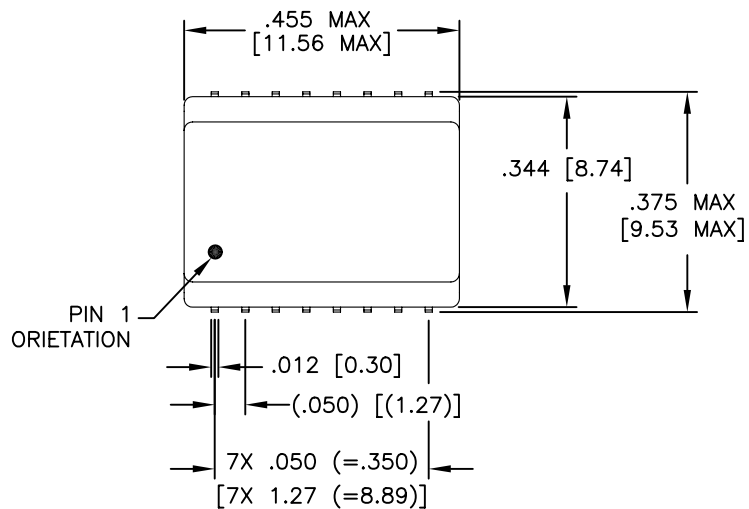

SUGGESTED LAND PATTERN

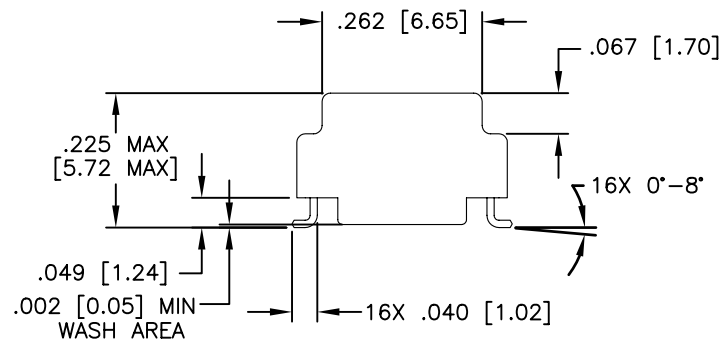
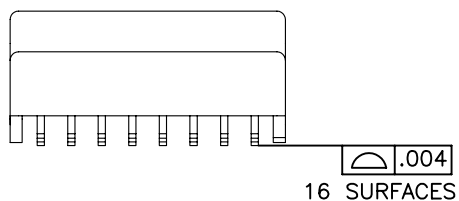

DIMENSIONS ARE IN INCHES [MILLIMETERS] WITH THE FOLLOWING TOLERANCES: [MILLIMETERS] ARE FOR REFERENCE ONLY.
 .XX= ±.01 [±0.25]
 .XXX= ±.005 [±0.13]

© Copyright, 2014. Pulse Electronics Corp. All rights reserved. Pulse confidential & proprietary. (06/11/14)

PRODUCT DESCRIPTION	TLA DRAWING	PS DRAWING	SHEET	PART NO.	DATASHEET REV.
XFMR,SIN,10D,1:2,SM,TU	23Z467SMFNL-11	PS-2755.001-A	3 OF 3	23Z467SMFNL	A

单击下面可查看定价，库存，交付和生命周期等信息

[>>Pulse\(普思\)](#)