

SMT POWER INDUCTORS

Power Beads - PA249xHL Series Coupled Inductors

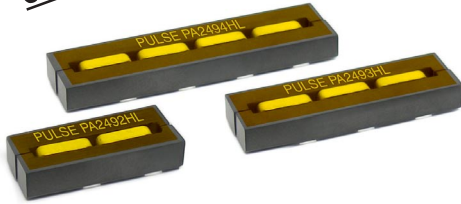
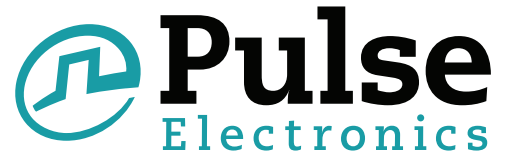

- Gen2.0 Coupled Inductors (PA249xHL) enables higher efficiency due to lower switching losses and lower conduction losses
- For use only with Volterra® multi-phase chipsets in applications demanding a fast transient response and high density
- Halogen Free and RoHS compliant

Electrical Specifications @ 25°C — Operating Temperature -40°C to +130°C

Pulse Part No.	Number of Coupled Phases	Equivalent ¹ Transient Inductance per Phase (nH)	Isat ² per Phase (A _{pk})	Magnetizing Inductance per Phase ³ nH Min, 0A _{dc}				DCR/Phase ⁴ (mΩ)
				L1	L2	L3	L4	TYP
				(1-2)	(3-4)	(5-6)	(7-8)	
PA2492HL	2	50	80	150	150	–	–	0.31
PA2493HL	3	50	80	250	250	250	–	
PA2494HL	4	50	80	350	350	350	350	

NOTES:

- In a non-coupled multi-phase topology, the power supply sees the same inductance during transient and steady-state conditions. As a result, any attempt to lower the inductance to improve transient response has the negative result of increasing ripple and peak currents throughout the system during steady-state operation. However, in a coupled inductor multi-phase topology, the interaction of magnetic fields from each phase enables an overall reduction in ripple current during steady-state operation and a lower equivalent inductance during transient operation. The equivalent transient inductance per phase, as listed, represents the actual value of inductance that would be required in a non-coupled topology to realize the same transient performance. This value is achieved by core and winding geometry and is not directly measured by Pulse. For more information on the operation of the coupled inductor topology, please contact Volterra.
- The rated current per phase is based on Volterra's testing of the Pulse coupled inductors.
- The magnetizing inductance per phase is the measured inductance (at 0A_{dc}) across each phase when all other phases are open-circuit. The magnetizing inductance is measured at 100kHz, 100mV_{rms}.
- The nominal value of DCR is measured from points Ⓐ to Ⓑ, as shown on the mechanical drawing for PA2492HL.

Mechanical

Schematic

PA2492HL

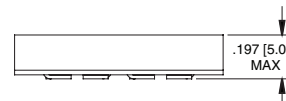
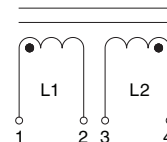
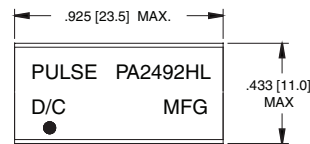
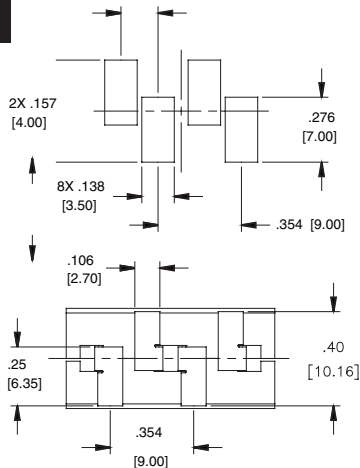

SMT POWER INDUCTORS

Power Beads - PA249xHL Series Coupled Inductors

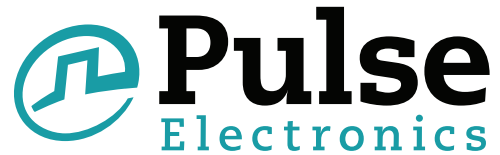

Mechanical

Schematic

PA2493HL

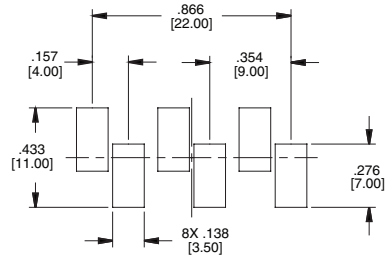

SUGGESTED LAND PATTERN

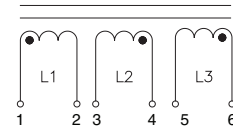
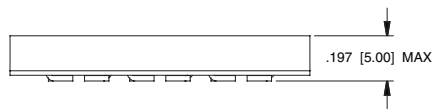
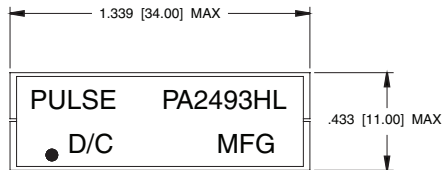
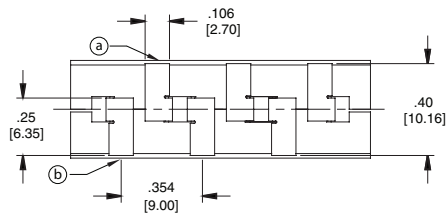

Mechanical

Schematic

PA2494HL

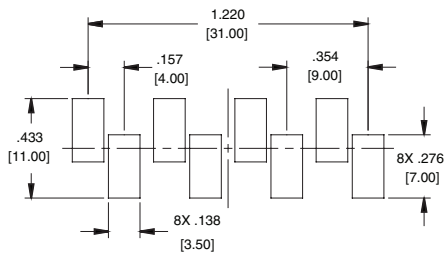

SUGGESTED LAND PATTERN

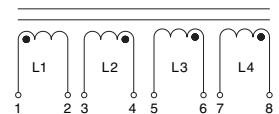
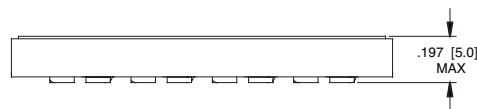
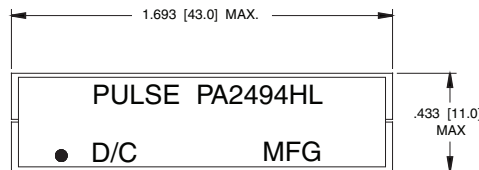
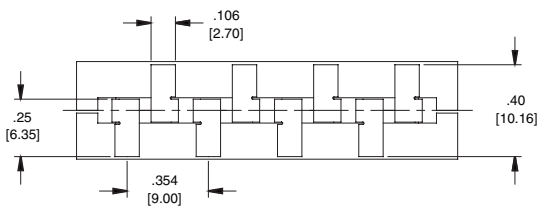

For More Information:

Pulse North American Headquarters

12220 World Trade Dr.
San Diego, CA 92128
U.S.A.

TEL: 858 674 8100
FAX: 858 674 8262

Pulse European Headquarters

Einsteinstrasse 1
D-71083 Herrenberg
Germany

TEL: 49 7032 7806 0
FAX: 49 7032 7806 12

Pulse China Headquarters

B402, Shenzhen Academy of
Aerospace Technology Bldg.
10th Kejinan Rd.
High-Tech Zone
Nanshan District
Shenzhen, PR China 518057

TEL: 86 755 33966678
FAX: 86 755 33966700

Pulse North China

Room 1503
XinYin Building
No. 888 YiShan Rd.
Shanghai 200233
China

TEL: 86 21 32181071
FAX: 86 21 32181396

Pulse South Asia

150 Kampong Ampat
#07-01/02
KA Centre
Singapore 368324

TEL: 65 6287 8998
FAX: 65 6280 0080

Pulse North Asia

No. 26
Kao Ching Rd.
Yang Mei Chen
Taoyuan Hsien
Taiwan, R. O. C.
32667

TEL: 886 3 4643715
FAX: 886 3 4641911

Performance warranty of products offered on this data sheet is limited to the parameters specified. Data is subject to change without notice. Other brand and product names mentioned herein may be trademarks or registered trademarks of their respective owners. Pulse and the Squarewave logo are trademarks of Pulse Electronics Corporation, registered in the U.S. and other countries. © Copyright, 2010. Pulse Electronics Corporation. All rights reserved.

单击下面可查看定价，库存，交付和生命周期等信息

[>>Pulse\(普思\)](#)