

Description: Vehicular Multiband Antenna with Adhesive Mount

PART NUMBER: ARMXXXXXAM



Features:

- Low profile, only 1.8" tall
- Up to 6-lead Configuration
 - LTE(2x) MIMO
 - WiFi(3x) MIMO-|2.4/5.x GHz
 - GPS/GNSS (1x)
- Frequency of Operation:
 - 698-960MHz,1710-2690MHz
 - 2400-2500MHz,5150-5925MHz
 - 1559-1606MHz

Applications:

- Telematics, Navigation
- First Responders(Police, Fire, Ambulance/EMS)
- Energy, Utility, Construction
- Fleet Management
- DSRC(Dedicated Short Range Communications)
- Available Configurations:
 - Black, White
 - Direct, Magnetic, Adhes.Mount

Issue: 1901

In the effort to improve our products, we reserve the right to make changes judged to be necessary.

CONFIDENTIAL AND PROPRIETARY INFORMATION

This document contains confidential and proprietary information of Pulse Electronics, Inc. (Pulse) and is protected by copyright, trade secret and other state and federal laws. Its receipt or possession does not convey any rights to reproduce, disclose its contents, or to manufacture, use or sell anything it may describe. Reproduction, disclosure or use without specific written authorization of Pulse is strictly forbidden.

For more information:

Pulse Worldwide Headquarters
15255 Innovation Drive #100
San Diego, CA 92128
USA
Tel:1-858-674-8100

Pulse/Larsen Antennas
18110 SE 34th St Bldg 2 Suite 250
Vancouver, WA 98683
USA
Tel: 1-360-944-7551

Europe Headquarters
Pulse GmbH & Do, KG
Zeppelinstrasse 15
Herrenberg, Germany

Pulse (Suzhou) Wireless Products Co, Inc.
99 Huo Ju Road(#29 Bldg,4th Phase
Suzhou New District
Jiangsu Province, Suzhou 215009 PR China
Tel: 86 512 6807 9998

Series: ARMADILLO

Description: Vehicular Multiband Antenna with Adhesive Mount

PART NUMBER: ARMXXXXXAM

This document covers all product variants of the following product family

Product	Total Cable Leads	LTE Cable Leads	WiFi Cable Leads	GPS Cable Leads	Housing Color	Cable Length	Mounting
ARM62311AM	6	2 (with SMA Male)	3 (with RP-SMA Male)	1 (with SMA Male)	Black	17 FT or 5181mm	Adhesive Mount; 3M VHB4959 Thickness: 3mm
ARM62312AM	6	2 (with SMA Male)	3 (with RP-SMA Male)	1 (with SMA Male)	White		
ARM52211AM	5	2 (with SMA Male)	2 (with RP-SMA Male)	1 (with SMA Male)	Black		
ARM52212AM	5	2 (with SMA Male)	2 (with RP-SMA Male)	1 (with SMA Male)	White		
ARM42111AM	4	2 (with SMA Male)	1 (with RP-SMA Male)	1 (with SMA Male)	Black		
ARM42112AM	4	2 (with SMA Male)	1 (with RP-SMA Male)	1 (with SMA Male)	White		
ARM32011AM	3	2 (with SMA Male)	0	1 (with SMA Male)	Black		
ARM32012AM	3	2 (with SMA Male)	0	1 (with SMA Male)	White		
ARM21011AMTT	2	1 (with TNC Male)	0	1 (with TNC Male)	Black		

Product Numbering

Vehicular Multiband Antenna with Direct Mount

(Part Number)

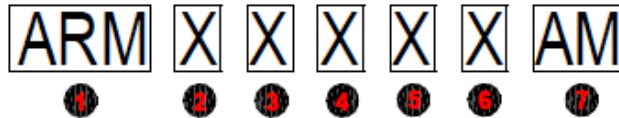

1	Product ID: ARMADILLO
2	Total Number of Cable leads
3	Total Number of LTE Cable Leads
4	Total Number of WiFi Cable Leads
5	Total Number of GPS Cable Leads
6	The Color of the Plastic Housing 1=Black; 2= White
7	Mounting: Adhesive Mount

Issue: 1901

In the effort to improve our products, we reserve the right to make changes judged to be necessary.

CONFIDENTIAL AND PROPRIETARY INFORMATION

This document contains confidential and proprietary information of Pulse Electronics, Inc. (Pulse) and is protected by copyright, trade secret and other state and federal laws. Its receipt or possession does not convey any rights to reproduce, disclose its contents, or to manufacture, use or sell anything it may describe. Reproduction, disclosure or use without specific written authorization of Pulse is strictly forbidden.

Description: Vehicular Multiband Antenna with Adhesive Mount

Series: ARMADILLO

PART NUMBER: ARMXXXXXAM

ELECTRICAL SPECIFICATIONS

Frequency	698-960MHz, 1710-2690MHz 2400-2500MHz, 5150-5925MHz
Nominal Impedance	50 Ω
VSWR*	
698-960MHz	<2.5
1710-2690MHz	<2.5
2400-2500MHz	<2
5150-5925MHz	<2
Isolation*	
698-960MHz, 1710-2690MHz	-8dB
2400-2500MHz, 5150-5925MHz	-12dB
Average Peak Gain**	
698-960MHz;	4.6dBi
1710-2690MHz	5.1dBi
2400-2500MHz	4.9dBi
5150-5925MHz	7.9dBi
Polarization	Vertical

*Test on 500mm ground plane with 17ft(5.2m) LMR195 cable

**Test on 500mm ground plane with 1ft(304.8) LMR195 cable

Series: ARMADILLO

Description: Vehicular Multiband Antenna with Adhesive Mount

PART NUMBER: ARMXXXXXAM

ELECTRICAL SPECIFICATIONS

GPS Antenna	
Frequency	1561.098±2.046MHz/ 1575.42±1.023MHz/ 1602.5625±4MHz
Nominal Impedance	50 Ω
VSWR	<2
Gain (Radiating Element)	1 dBic±1 dB
Gain (LNA Gain)	30 dB± 2 dB
Polarization	RHCP
Out of Band Rejection	
698 MHz	>70 dB
960 MHz	>65 dB
1710 MHz	>60 dB
2170 MHz	>65 dB
2400 MHz	>65 dB
2700 MHz	>65 dB
Noise Figure	<2.4 dB
Operating Voltage	3.3 – 5 Vdc
Current Consumption	<15mA

Issue: 1901

In the effort to improve our products, we reserve the right to make changes judged to be necessary.

CONFIDENTIAL AND PROPRIETARY INFORMATION

This document contains confidential and proprietary information of Pulse Electronics, Inc. (Pulse) and is protected by copyright, trade secret and other state and federal laws. Its receipt or possession does not convey any rights to reproduce, disclose its contents, or to manufacture, use or sell anything it may describe. Reproduction, disclosure or use without specific written authorization of Pulse is strictly forbidden.

Downloaded From Oneyac.com

Series: ARMADILLO

Description: Vehicular Multiband Antenna with Adhesive Mount

PART NUMBER: ARMXXXXXAM

MECHANICAL SPECIFICATIONS

Overall Length	202.3mm X 88.5mm X 45mm
Weight	1 Kg
Antenna Color / Material	Black or White
Connector type	Refer to Page 2
Cable type	Refer to Page 2
Cable length	Refer to Page 2

ENVIRONMENTAL SPECIFICATIONS

Operating Temperature	-40 ~ +85° C
Storage Temperature	-40 ~ +85° C
Ingress Protection	IP67
RoHS Compliant	Yes

OTHER SPECIFICATIONS

Total cable assembly loss for 5.2m (17') LMR-195 @850MHz	2.1dB
Total cable assembly loss for 5.2m (17') LMR-100 @1575MHz	5.9dB
Total cable assembly loss for 5.2m (17') LMR-195 @1930MHz	3.2dB
Total cable assembly loss for 5.2m (17') LMR-195 @2450MHz	3.6dB
Total cable assembly loss for 5.2m (17') LMR-195 @2500MHz	3.7dB
Total cable assembly loss for 5.2m (17') LMR-195 @5350MHz	5.5dB

Series: ARMADILLO

Description: Vehicular Multiband Antenna with Adhesive Mount

PART NUMBER: ARMXXXXXAM

MECHANICAL DRAWING

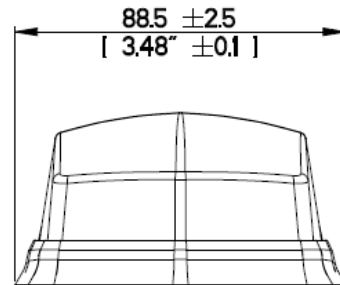
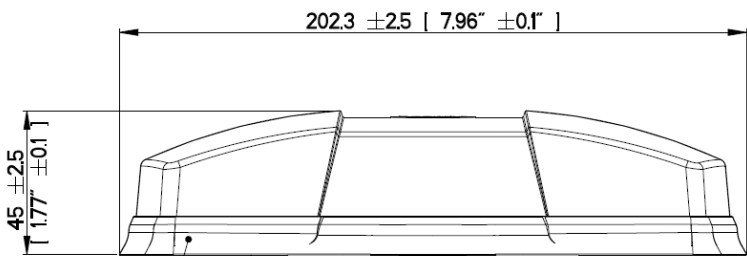
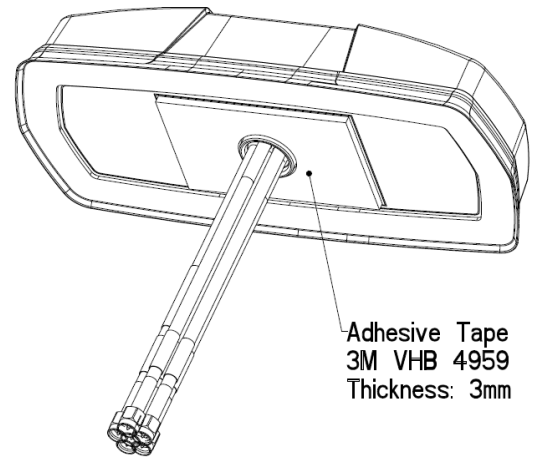
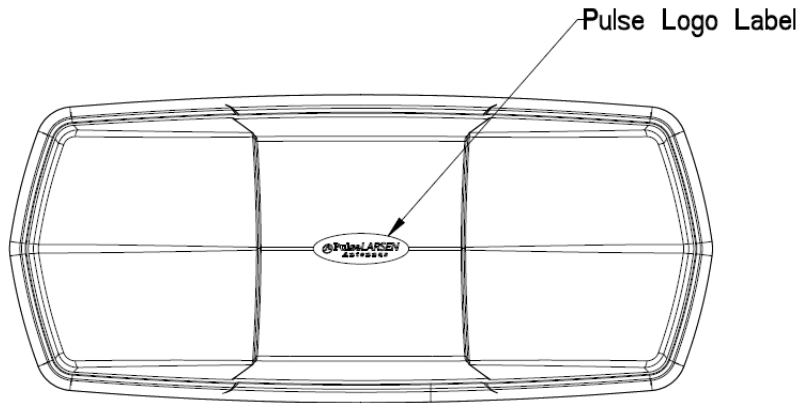

Rubber Gasket

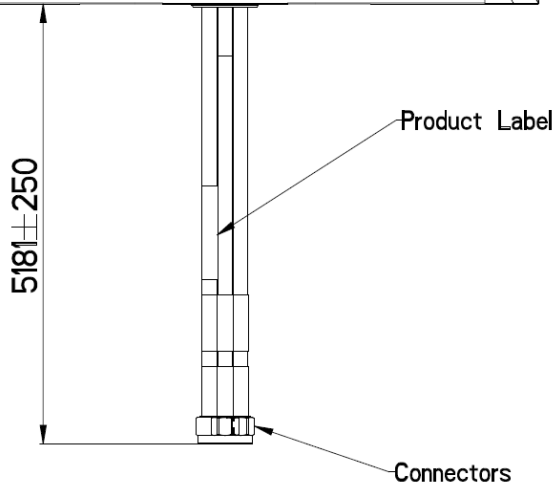

Issue: 1901

In the effort to improve our products, we reserve the right to make changes judged to be necessary.

CONFIDENTIAL AND PROPRIETARY INFORMATION

This document contains confidential and proprietary information of Pulse Electronics, Inc. (Pulse) and is protected by copyright, trade secret and other state and federal laws. Its receipt or possession does not convey any rights to reproduce, disclose its contents, or to manufacture, use or sell anything it may describe. Reproduction, disclosure or use without specific written authorization of Pulse is strictly forbidden.

Description: Vehicular Multiband Antenna with Adhesive Mount

Series: ARMADILLO

PART NUMBER: ARMXXXXAM

MECHANICAL DRAWING

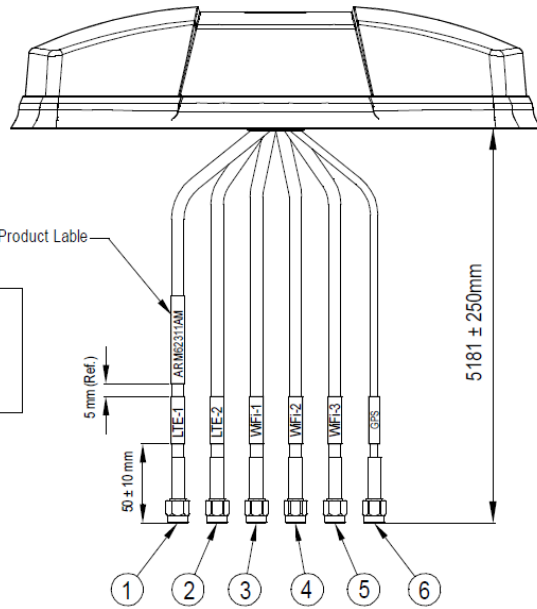

Product Label Content
 P.N.: ARM62311AM
 Rev.: V01
 Date: DD-MM-YYYY

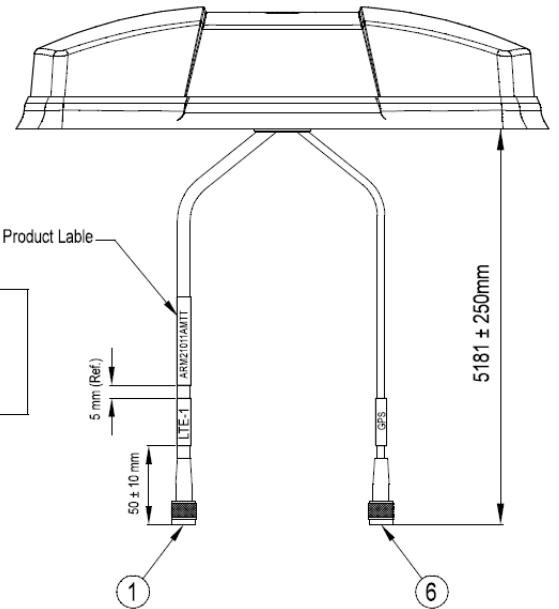

Product Label Content
 P.N.: ARM21011AMTT
 Rev.: V01
 Date: DD-MM-YYYY

ARM62311AM		CABLE	CABLE LENGTH	CONNECTOR
1	LTE-1 Cable Assy	LMR-195*	5181 mm / 204" / 17 FT	SMA Male
2	LTE-2 Cable Assy			SMA Male
3	WiFi-1 Cable Assy	LMR-195*		RP-SMA Male
4	WiFi-2 Cable Assy			RP-SMA Male
5	WiFi-3 Cable Assy			RP-SMA Male
6	GPS Cable Assy	LMR-100*		SMA Male

* or equivalent

ARM21011AMTT		CABLE	CABLE LENGTH	CONNECTOR
1	LTE-1 Cable Assy	LMR-195*	5181 mm / 204" / 17 FT	TNC Male
2				TNC Male
		LMR-100*		TNC Male
				TNC Male
				TNC Male
6	GPS Cable Assy	LMR-100*		TNC Male

* or equivalent

Issue: 1901

In the effort to improve our products, we reserve the right to make changes judged to be necessary.

CONFIDENTIAL AND PROPRIETARY INFORMATION

This document contains confidential and proprietary information of Pulse Electronics, Inc. (Pulse) and is protected by copyright, trade secret and other state and federal laws. Its receipt or possession does not convey any rights to reproduce, disclose its contents, or to manufacture, use or sell anything it may describe. Reproduction, disclosure or use without specific written authorization of Pulse is strictly forbidden.

Series: ARMADILLO

Description: Vehicular Multiband Antenna with Adhesive Mount

PART NUMBER: ARMXXXXXAM

TEST SETUP

Antenna tested on a $\Phi 500\text{mm}$ ground plane.

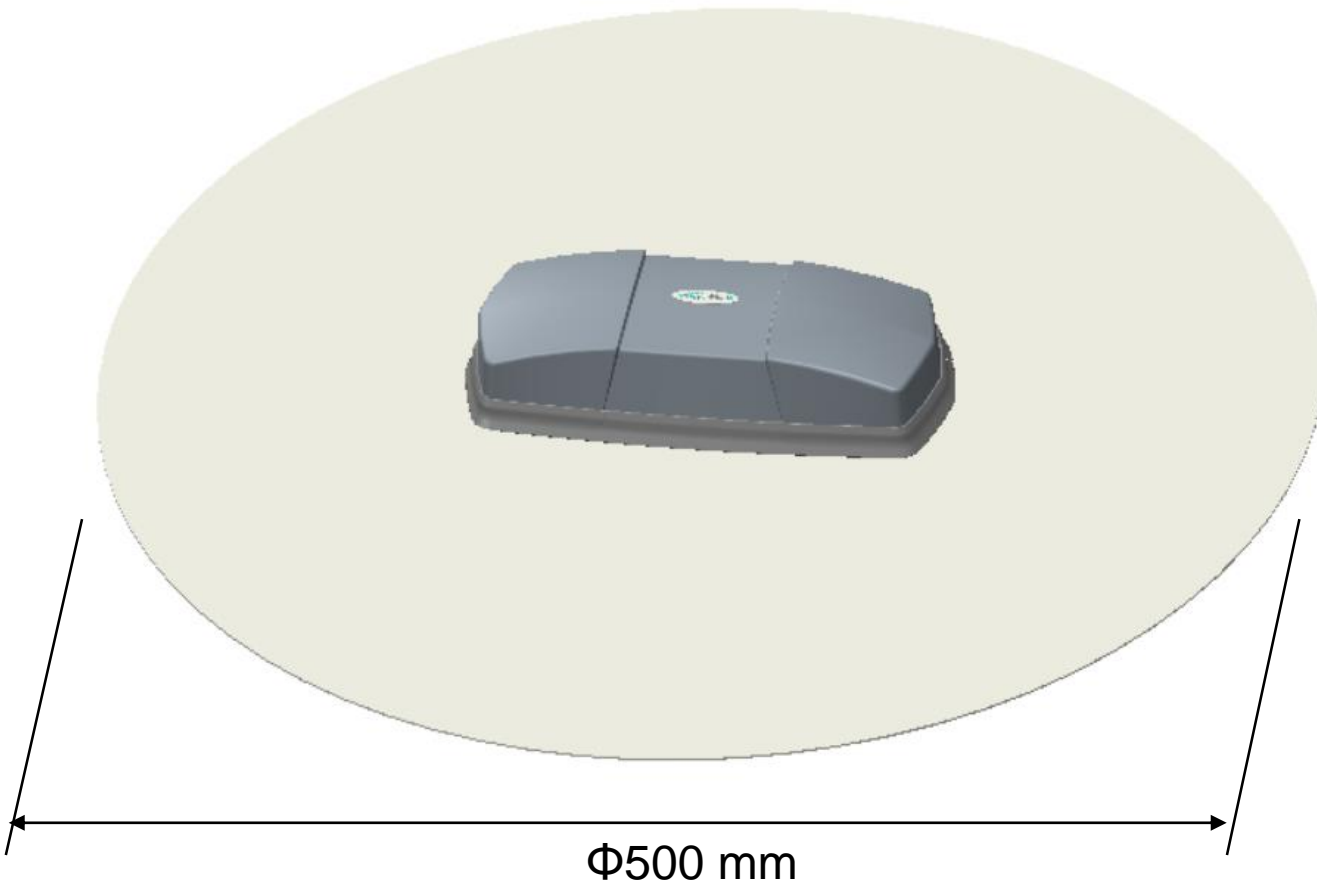

Issue: 1901

In the effort to improve our products, we reserve the right to make changes judged to be necessary.

CONFIDENTIAL AND PROPRIETARY INFORMATION

This document contains confidential and proprietary information of Pulse Electronics, Inc. (Pulse) and is protected by copyright, trade secret and other state and federal laws. Its receipt or possession does not convey any rights to reproduce, disclose its contents, or to manufacture, use or sell anything it may describe. Reproduction, disclosure or use without specific written authorization of Pulse is strictly forbidden.

Downloaded From Oneyac.com

Series: ARMADILLO

Description: Vehicular Multiband Antenna with Adhesive Mount

PART NUMBER: ARMXXXXXAM

CHARTS

VSWR (LTE)

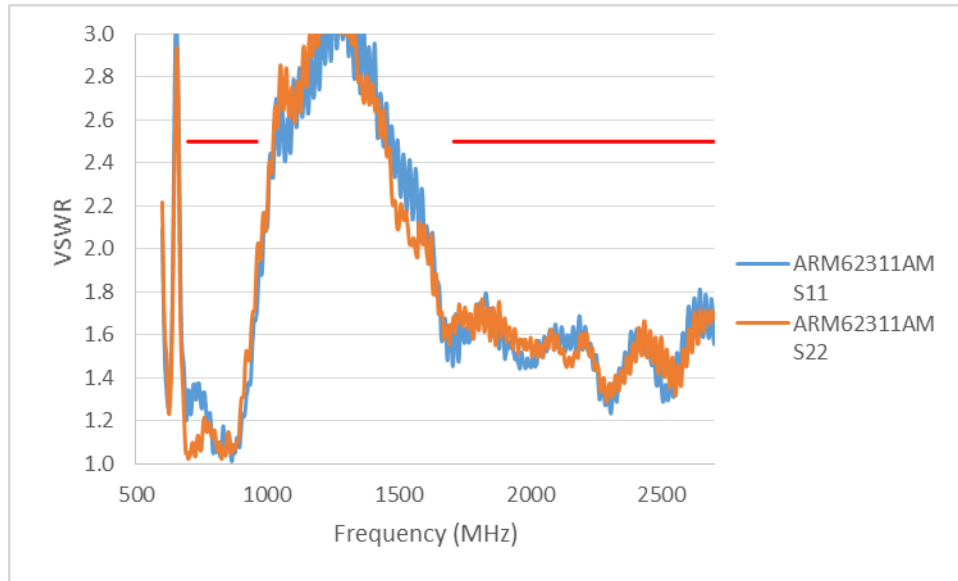

Isolation (LTE)

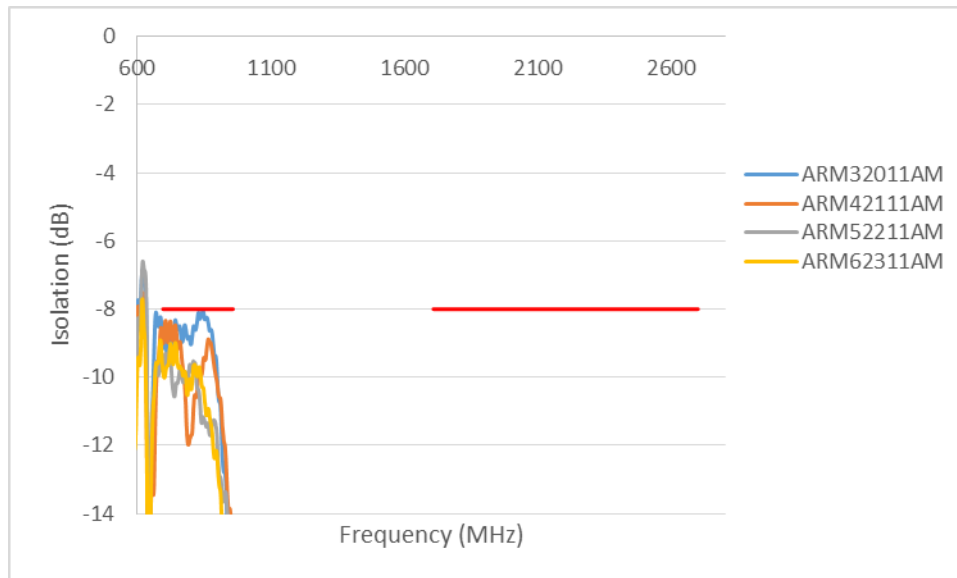

Note : Antenna tested with 5m cable on 500mm (dia) ground plane

Issue: 1901

In the effort to improve our products, we reserve the right to make changes judged to be necessary.

CONFIDENTIAL AND PROPRIETARY INFORMATION

This document contains confidential and proprietary information of Pulse Electronics, Inc. (Pulse) and is protected by copyright, trade secret and other state and federal laws. Its receipt or possession does not convey any rights to reproduce, disclose its contents, or to manufacture, use or sell anything it may describe. Reproduction, disclosure or use without specific written authorization of Pulse is strictly forbidden.

Series: ARMADILLO

Description: Vehicular Multiband Antenna with Adhesive Mount

PART NUMBER: ARMXXXXXAM

CHARTS

Radiation Efficiency (LTE)

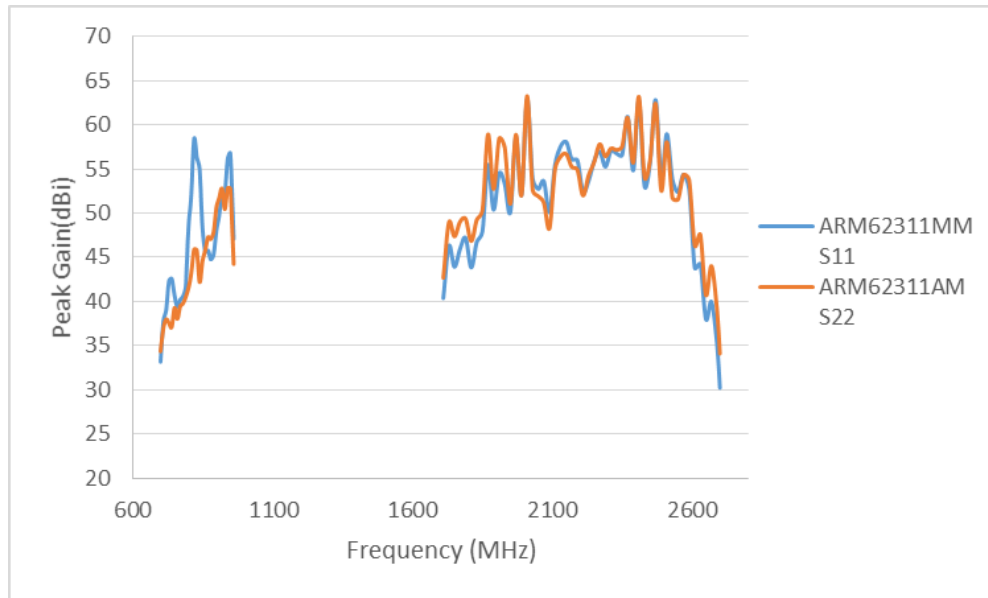

Peak Gain (LTE)

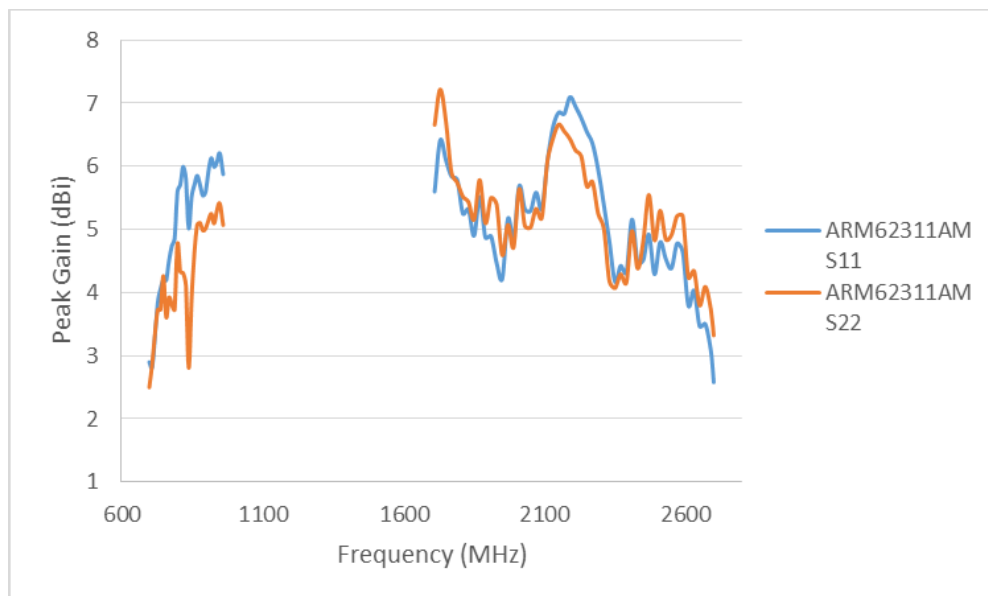

Note : Antenna tested with 1ft(304.8mm) cable on 500mm (dia) ground plane

Issue: 1901

In the effort to improve our products, we reserve the right to make changes judged to be necessary.

CONFIDENTIAL AND PROPRIETARY INFORMATION

This document contains confidential and proprietary information of Pulse Electronics, Inc. (Pulse) and is protected by copyright, trade secret and other state and federal laws. Its receipt or possession does not convey any rights to reproduce, disclose its contents, or to manufacture, use or sell anything it may describe. Reproduction, disclosure or use without specific written authorization of Pulse is strictly forbidden.

Series: ARMADILLO

Description: Vehicular Multiband Antenna with Adhesive Mount

PART NUMBER: ARMXXXXXAM

CHARTS

VSWR (WIFI)

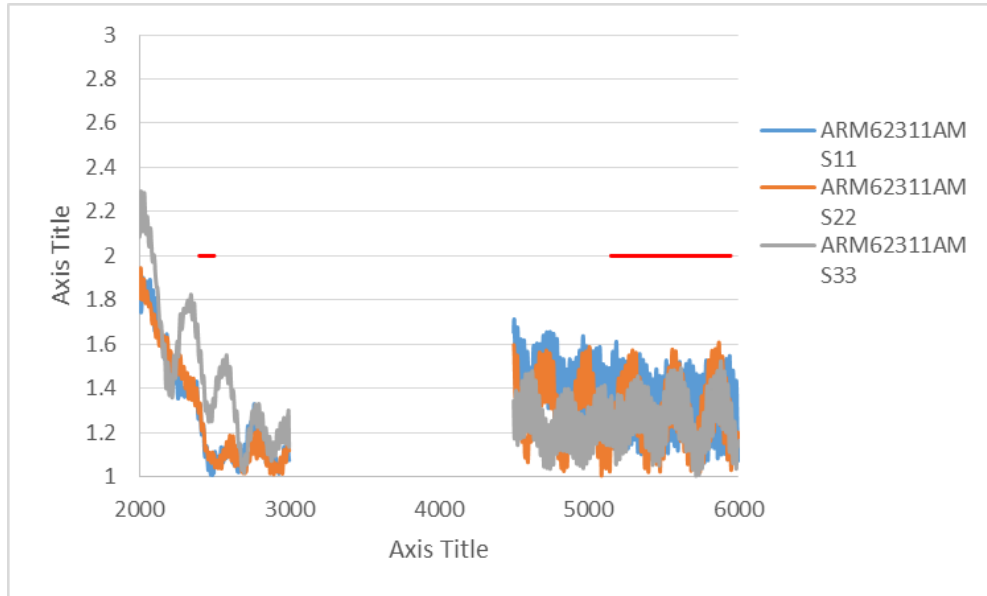

Isolation (WIFI)

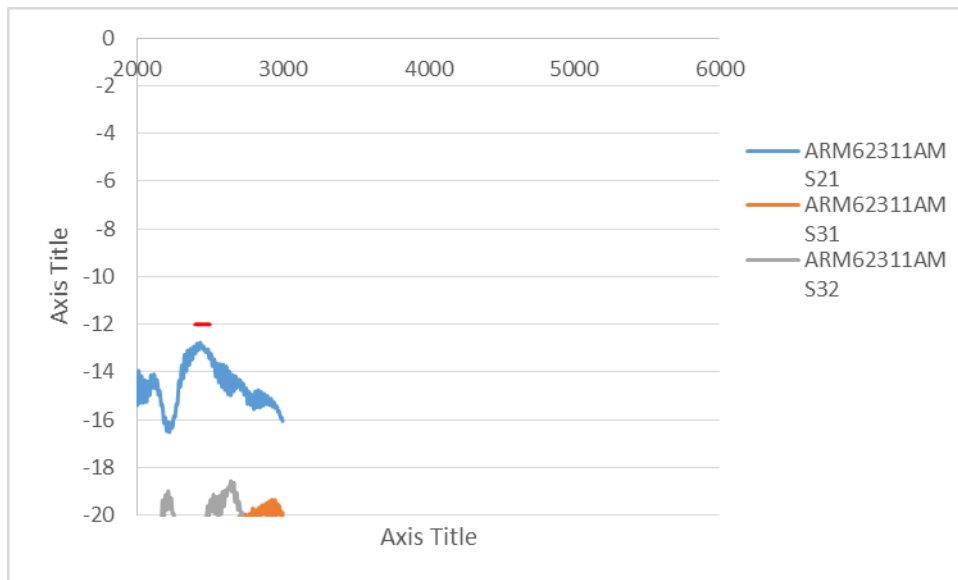

Note : Antenna tested with 5m cable on 500mm (dia) ground plane

Issue: 1901

In the effort to improve our products, we reserve the right to make changes judged to be necessary.

CONFIDENTIAL AND PROPRIETARY INFORMATION

This document contains confidential and proprietary information of Pulse Electronics, Inc. (Pulse) and is protected by copyright, trade secret and other state and federal laws. Its receipt or possession does not convey any rights to reproduce, disclose its contents, or to manufacture, use or sell anything it may describe. Reproduction, disclosure or use without specific written authorization of Pulse is strictly forbidden.

Series: ARMADILLO

Description: Vehicular Multiband Antenna with Adhesive Mount

PART NUMBER: ARMXXXXXAM

CHARTS

Radiation Efficiency (WIFI)

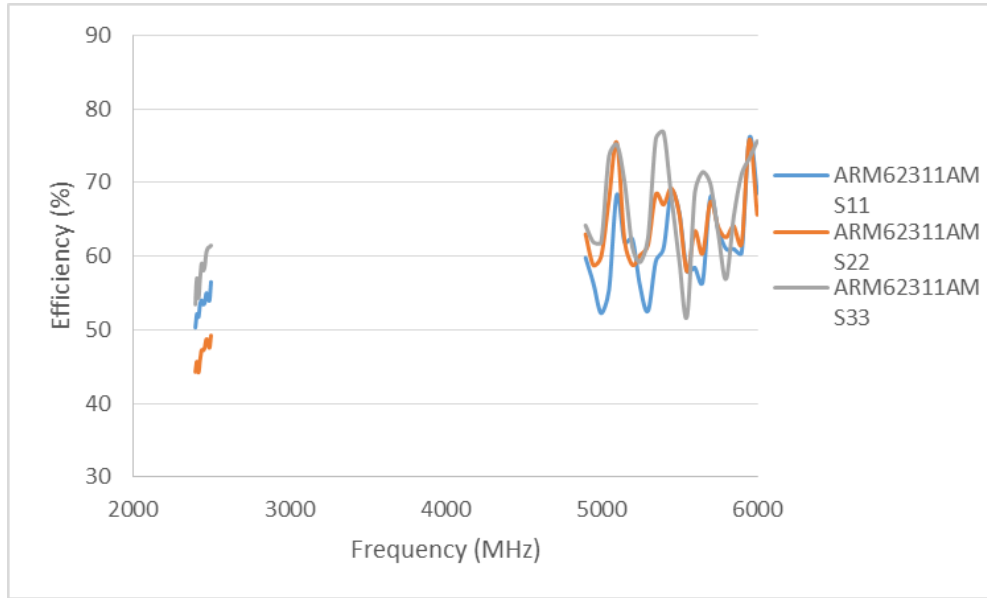

Peak Gain (WIFI)

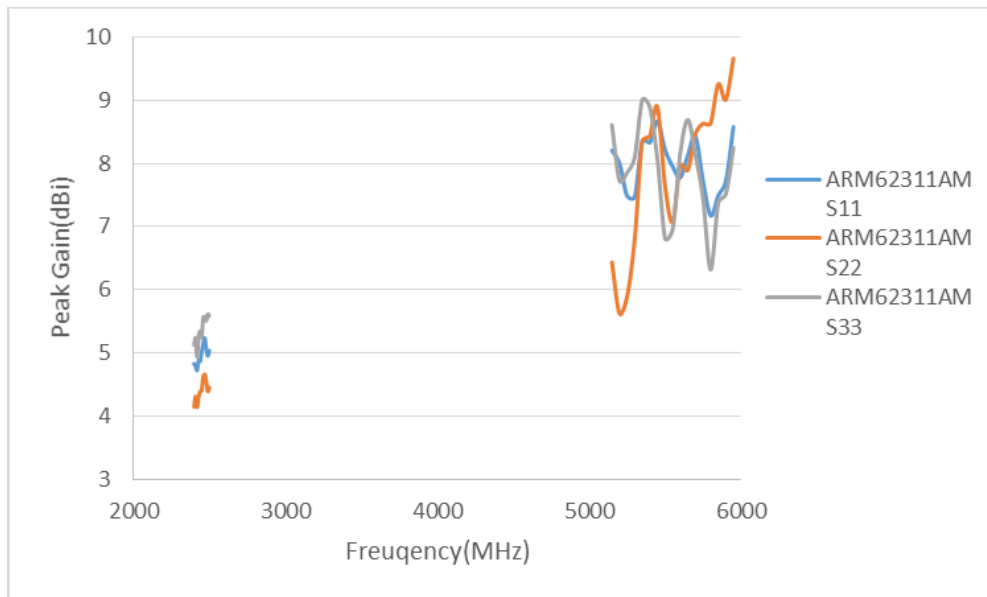

Note : Antenna tested with 1ft(304.8mm) cable on 500mm (dia) ground plane

Issue: 1901

In the effort to improve our products, we reserve the right to make changes judged to be necessary.

CONFIDENTIAL AND PROPRIETARY INFORMATION

This document contains confidential and proprietary information of Pulse Electronics, Inc. (Pulse) and is protected by copyright, trade secret and other state and federal laws. Its receipt or possession does not convey any rights to reproduce, disclose its contents, or to manufacture, use or sell anything it may describe. Reproduction, disclosure or use without specific written authorization of Pulse is strictly forbidden.

Series: ARMADILLO

Description: Vehicular Multiband Antenna with Adhesive Mount

PART NUMBER: ARMXXXXXAM

CHARTS

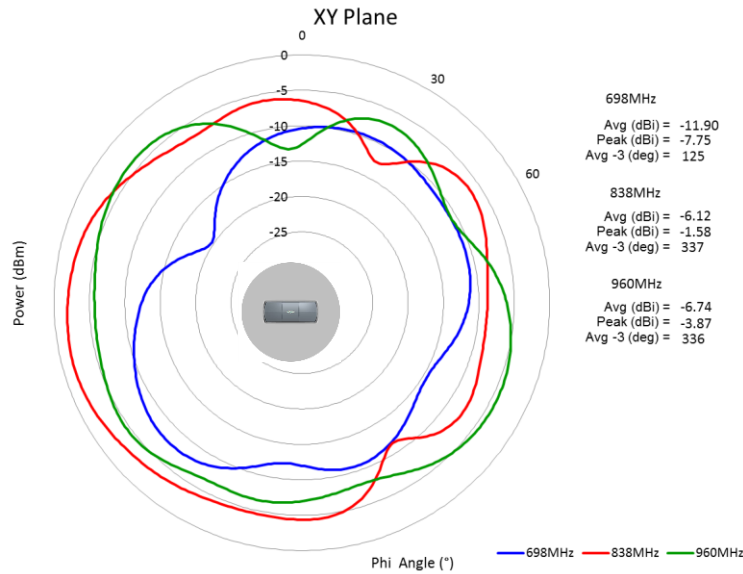

LTE1 XY plane radiation pattern

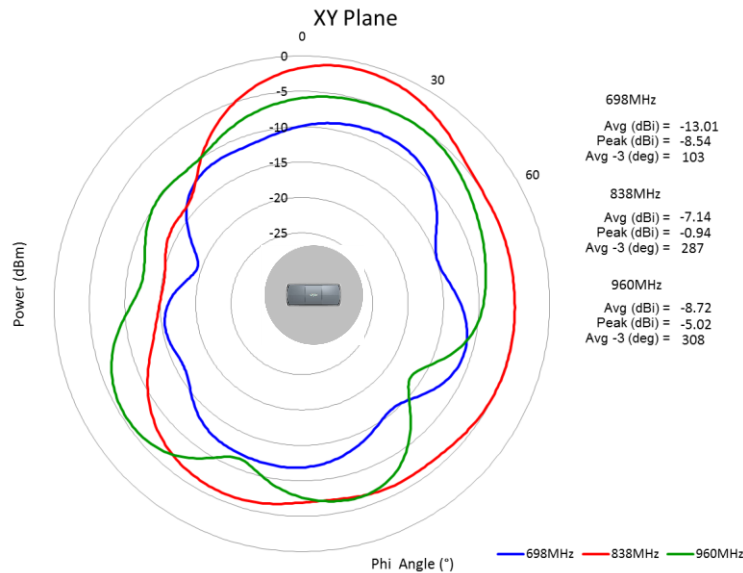

LTE2 XY plane radiation pattern

Issue: 1901

In the effort to improve our products, we reserve the right to make changes judged to be necessary.

CONFIDENTIAL AND PROPRIETARY INFORMATION

This document contains confidential and proprietary information of Pulse Electronics, Inc. (Pulse) and is protected by copyright, trade secret and other state and federal laws. Its receipt or possession does not convey any rights to reproduce, disclose its contents, or to manufacture, use or sell anything it may describe. Reproduction, disclosure or use without specific written authorization of Pulse is strictly forbidden.

Description: Vehicular Multiband Antenna with Adhesive Mount

Series: ARMADILLO

PART NUMBER: ARMXXXXXAM

CHARTS

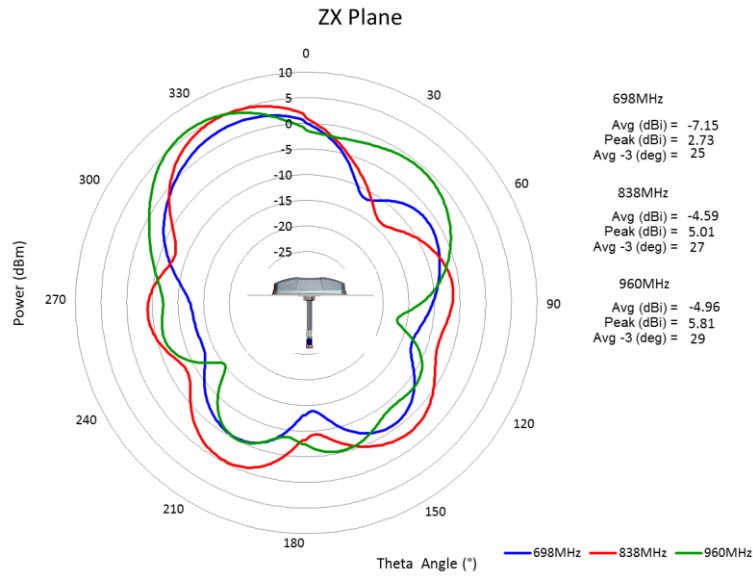

LTE1 ZX plane radiation pattern

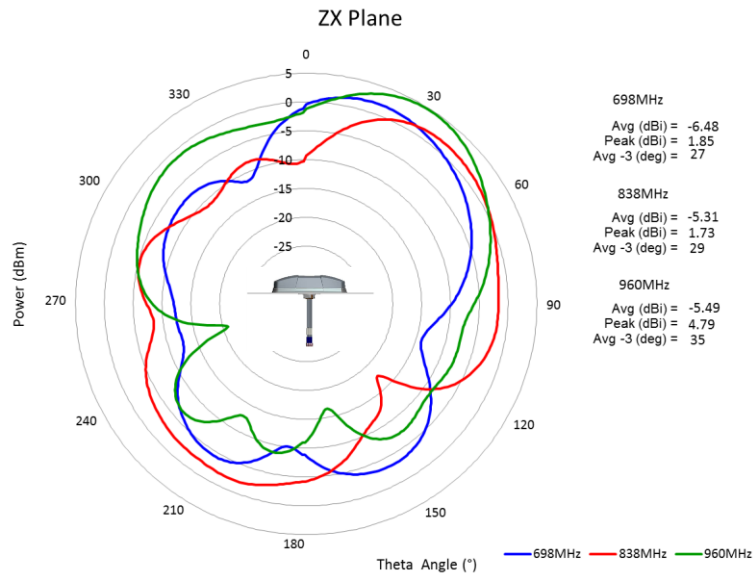

LTE2 ZX plane radiation pattern

Issue: 1901

In the effort to improve our products, we reserve the right to make changes judged to be necessary.

CONFIDENTIAL AND PROPRIETARY INFORMATION

This document contains confidential and proprietary information of Pulse Electronics, Inc. (Pulse) and is protected by copyright, trade secret and other state and federal laws. Its receipt or possession does not convey any rights to reproduce, disclose its contents, or to manufacture, use or sell anything it may describe. Reproduction, disclosure or use without specific written authorization of Pulse is strictly forbidden.

Description: Vehicular Multiband Antenna with Adhesive Mount

Series: ARMADILLO

PART NUMBER: ARMXXXXXAM

CHARTS

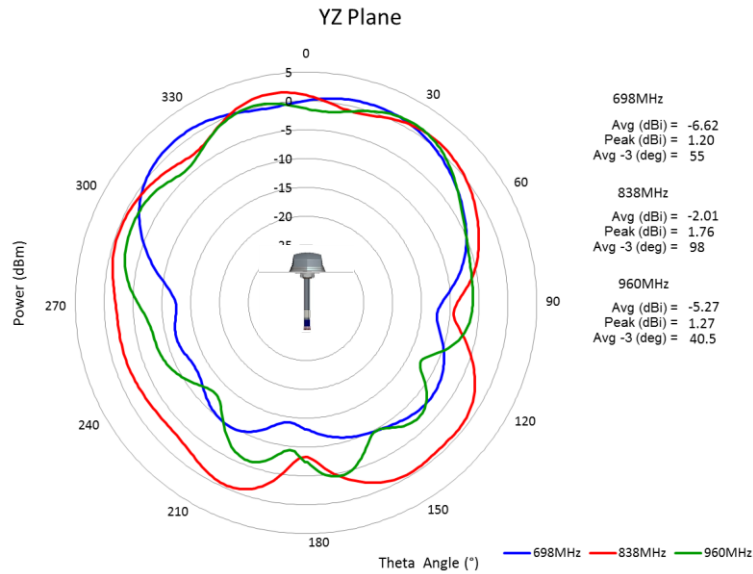

LTE1 YZ plane radiation pattern

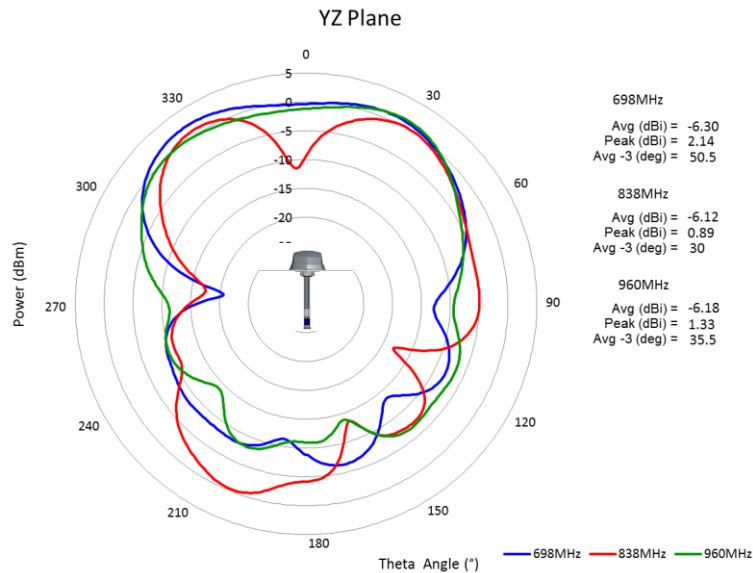

LTE2 YZ plane radiation pattern

Issue: 1901

In the effort to improve our products, we reserve the right to make changes judged to be necessary.

CONFIDENTIAL AND PROPRIETARY INFORMATION

This document contains confidential and proprietary information of Pulse Electronics, Inc. (Pulse) and is protected by copyright, trade secret and other state and federal laws. Its receipt or possession does not convey any rights to reproduce, disclose its contents, or to manufacture, use or sell anything it may describe. Reproduction, disclosure or use without specific written authorization of Pulse is strictly forbidden.

Series: ARMADILLO

Description: Vehicular Multiband Antenna with Adhesive Mount

PART NUMBER: ARMXXXXXAM

CHARTS

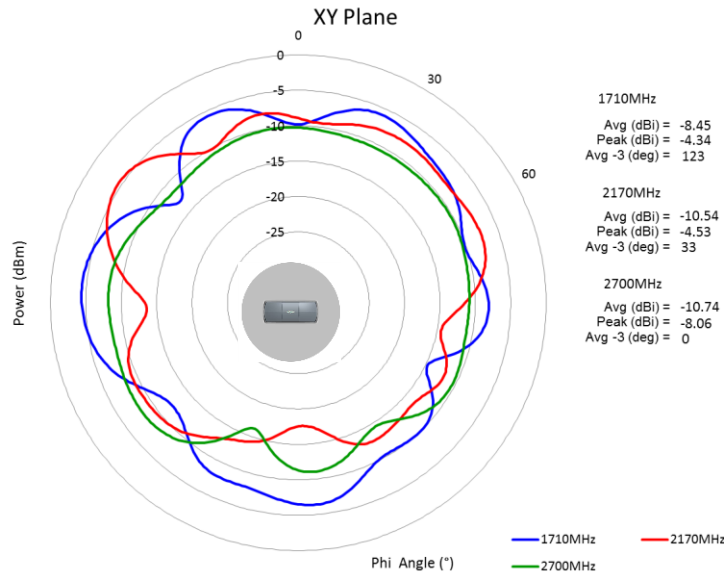

LTE1 XY plane radiation pattern

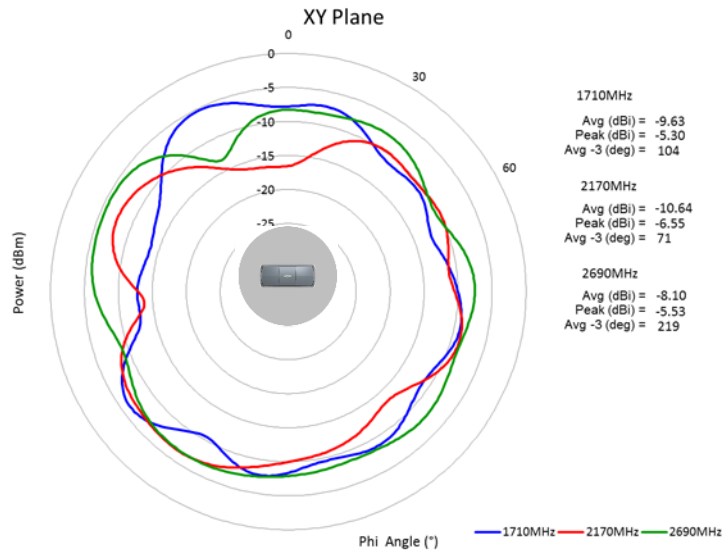

LTE2 XY plane radiation pattern

Issue: 1901

In the effort to improve our products, we reserve the right to make changes judged to be necessary.

CONFIDENTIAL AND PROPRIETARY INFORMATION

This document contains confidential and proprietary information of Pulse Electronics, Inc. (Pulse) and is protected by copyright, trade secret and other state and federal laws. Its receipt or possession does not convey any rights to reproduce, disclose its contents, or to manufacture, use or sell anything it may describe. Reproduction, disclosure or use without specific written authorization of Pulse is strictly forbidden.

Series: ARMADILLO

Description: Vehicular Multiband Antenna with Adhesive Mount

PART NUMBER: ARMXXXXXAM

CHARTS

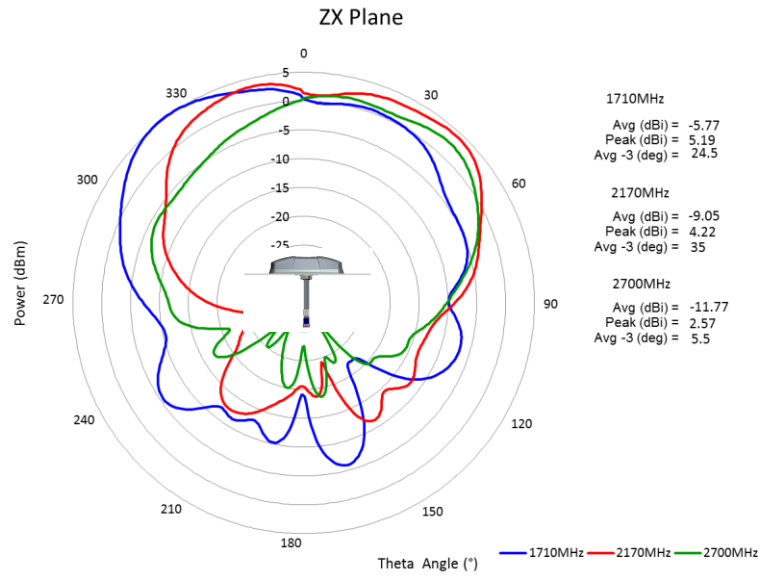

LTE1 ZX plane radiation pattern

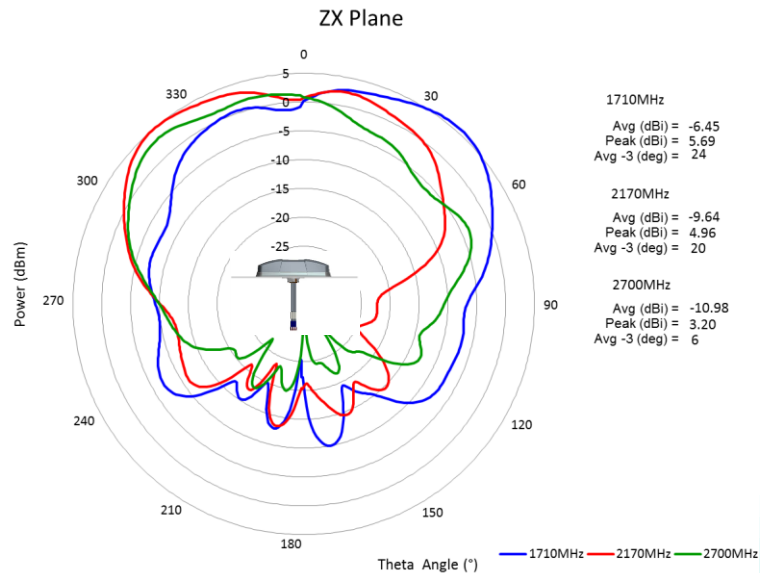

LTE2 ZX plane radiation pattern

Issue: 1901

In the effort to improve our products, we reserve the right to make changes judged to be necessary.

CONFIDENTIAL AND PROPRIETARY INFORMATION

This document contains confidential and proprietary information of Pulse Electronics, Inc. (Pulse) and is protected by copyright, trade secret and other state and federal laws. Its receipt or possession does not convey any rights to reproduce, disclose its contents, or to manufacture, use or sell anything it may describe. Reproduction, disclosure or use without specific written authorization of Pulse is strictly forbidden.

Description: Vehicular Multiband Antenna with Adhesive Mount

Series: ARMADILLO

PART NUMBER: ARMXXXXXAM

CHARTS

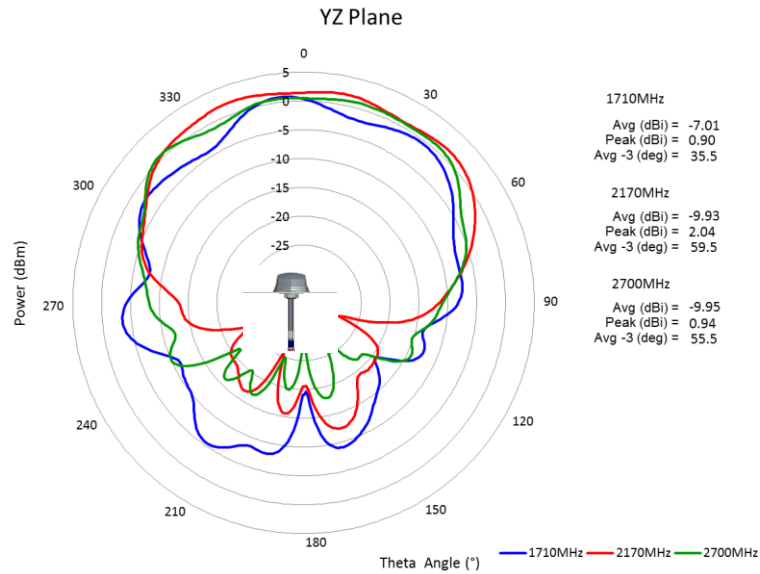

LTE1 YZ plane radiation pattern

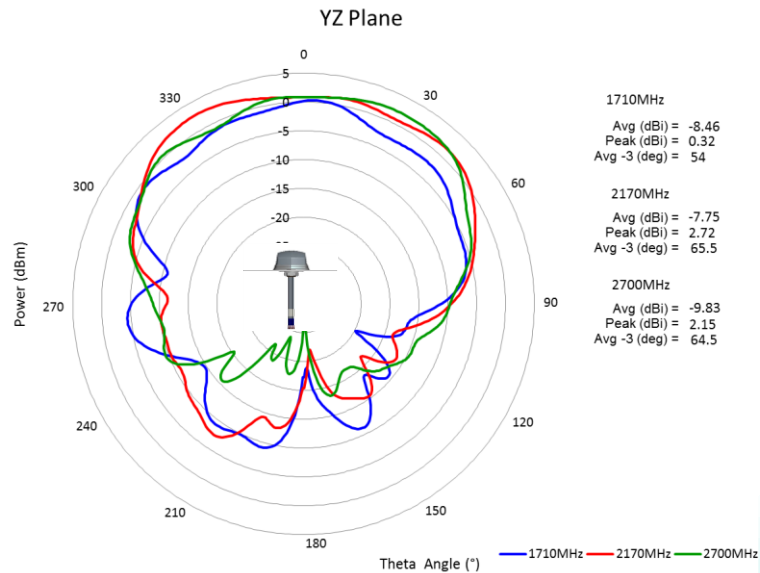

LTE2 YZ plane radiation pattern

Issue: 1901

In the effort to improve our products, we reserve the right to make changes judged to be necessary.

CONFIDENTIAL AND PROPRIETARY INFORMATION

This document contains confidential and proprietary information of Pulse Electronics, Inc. (Pulse) and is protected by copyright, trade secret and other state and federal laws. Its receipt or possession does not convey any rights to reproduce, disclose its contents, or to manufacture, use or sell anything it may describe. Reproduction, disclosure or use without specific written authorization of Pulse is strictly forbidden.

Series: ARMADILLO

Description: Vehicular Multiband Antenna with Adhesive Mount

PART NUMBER: ARMXXXXXAM

CHARTS

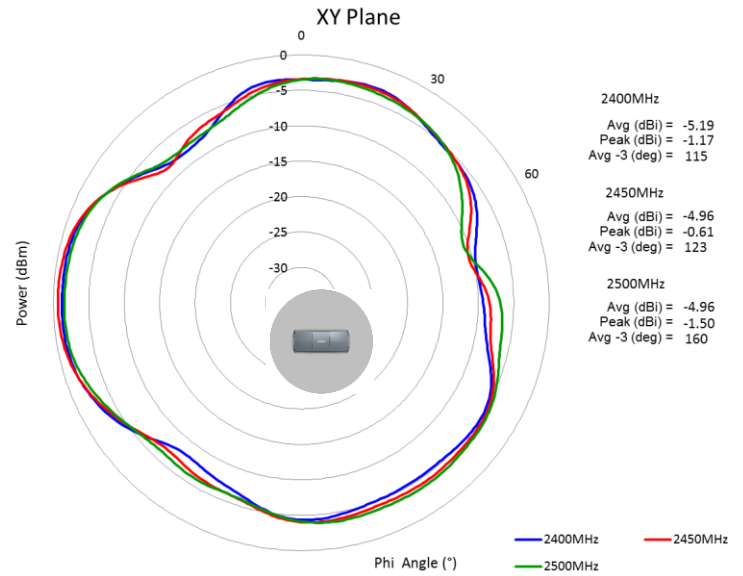
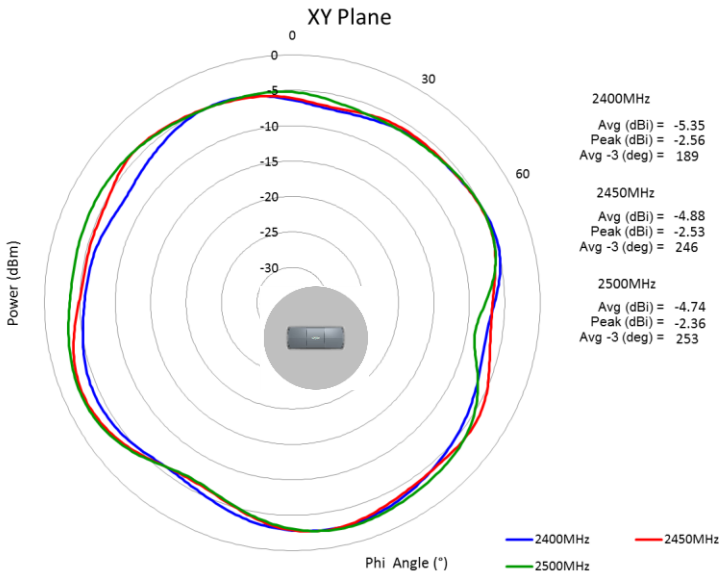

WiFi1 XY plane radiation pattern

WiFi2 XY plane radiation pattern

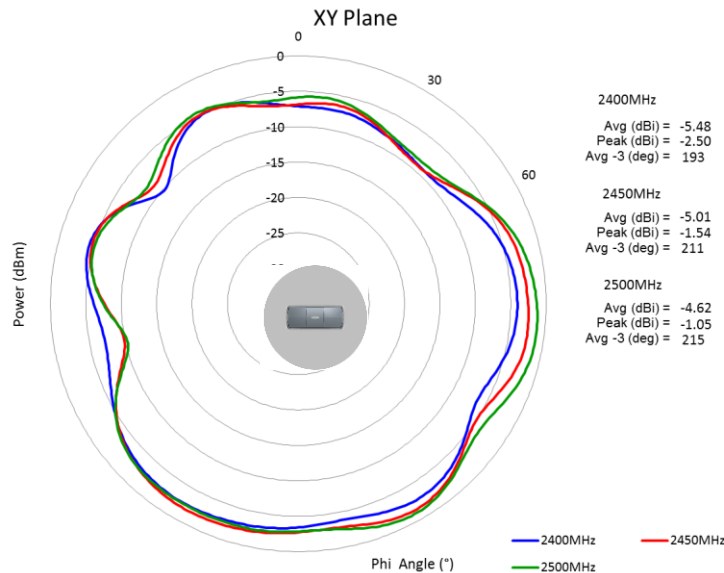

WiFi3 XY plane radiation pattern

Issue: 1901

In the effort to improve our products, we reserve the right to make changes judged to be necessary.

CONFIDENTIAL AND PROPRIETARY INFORMATION

This document contains confidential and proprietary information of Pulse Electronics, Inc. (Pulse) and is protected by copyright, trade secret and other state and federal laws. Its receipt or possession does not convey any rights to reproduce, disclose its contents, or to manufacture, use or sell anything it may describe. Reproduction, disclosure or use without specific written authorization of Pulse is strictly forbidden.

Description: Vehicular Multiband Antenna with Adhesive Mount

Series: ARMADILLO

PART NUMBER: ARMXXXXXAM

CHARTS

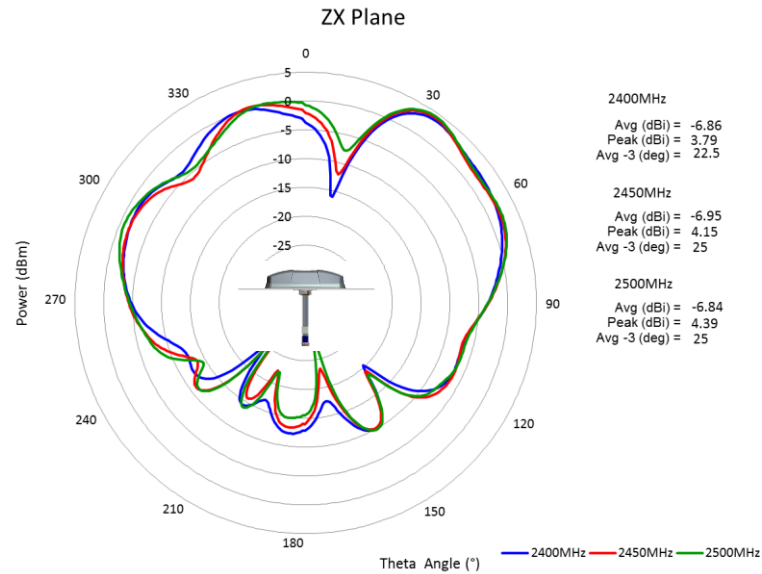
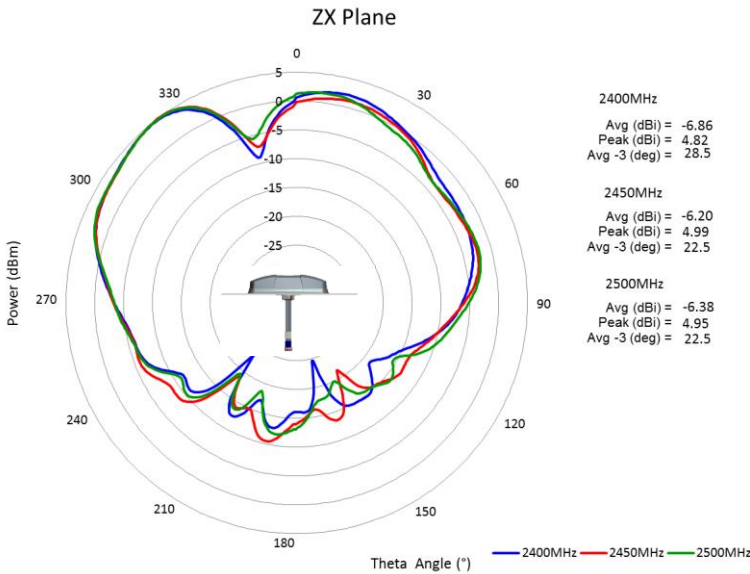

WiFi1 ZX plane radiation pattern

WiFi2 ZX plane radiation pattern

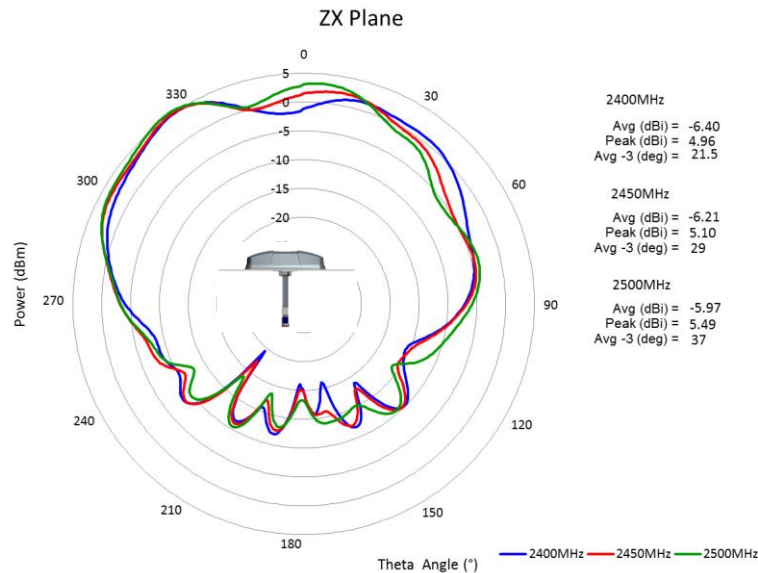

WiFi3 ZX plane radiation pattern

Issue: 1901

In the effort to improve our products, we reserve the right to make changes judged to be necessary.

CONFIDENTIAL AND PROPRIETARY INFORMATION

This document contains confidential and proprietary information of Pulse Electronics, Inc. (Pulse) and is protected by copyright, trade secret and other state and federal laws. Its receipt or possession does not convey any rights to reproduce, disclose its contents, or to manufacture, use or sell anything it may describe. Reproduction, disclosure or use without specific written authorization of Pulse is strictly forbidden.

Description: Vehicular Multiband Antenna with Adhesive Mount

Series: ARMADILLO

PART NUMBER: ARMXXXXXAM

CHARTS

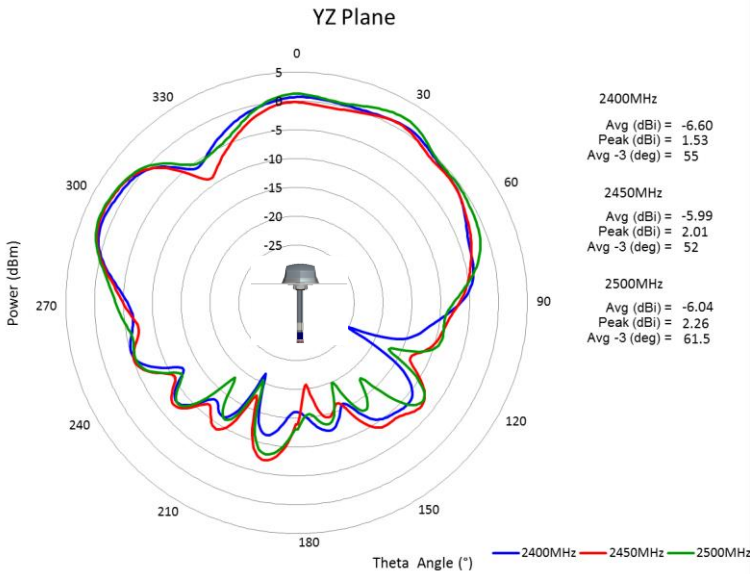

WiFi1 YZ plane radiation pattern

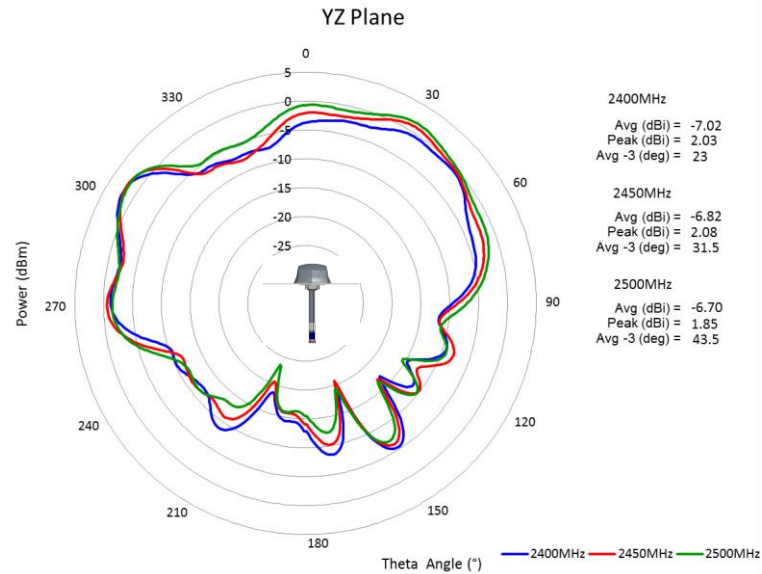

WiFi2 YZ plane radiation pattern

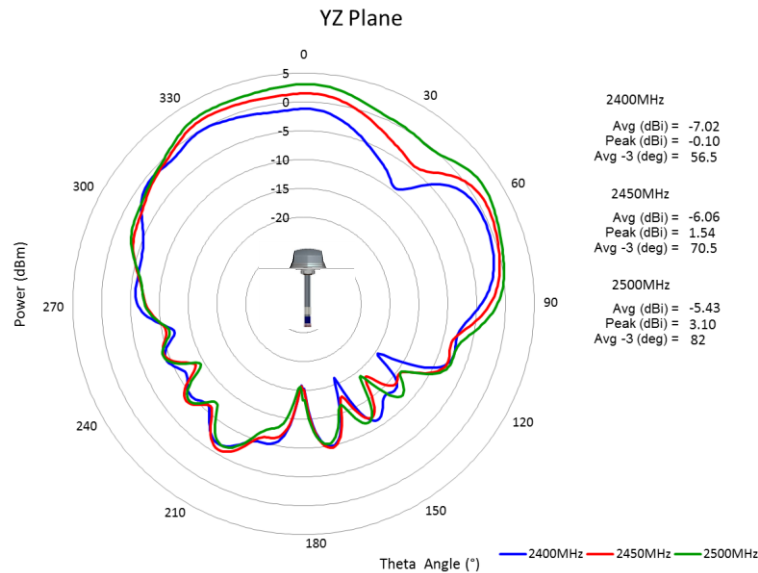

WiFi3 YZ plane radiation pattern

Issue: 1901

In the effort to improve our products, we reserve the right to make changes judged to be necessary.

CONFIDENTIAL AND PROPRIETARY INFORMATION

This document contains confidential and proprietary information of Pulse Electronics, Inc. (Pulse) and is protected by copyright, trade secret and other state and federal laws. Its receipt or possession does not convey any rights to reproduce, disclose its contents, or to manufacture, use or sell anything it may describe. Reproduction, disclosure or use without specific written authorization of Pulse is strictly forbidden.

Series: ARMADILLO

Description: Vehicular Multiband Antenna with Adhesive Mount

PART NUMBER: ARMXXXXXAM

CHARTS

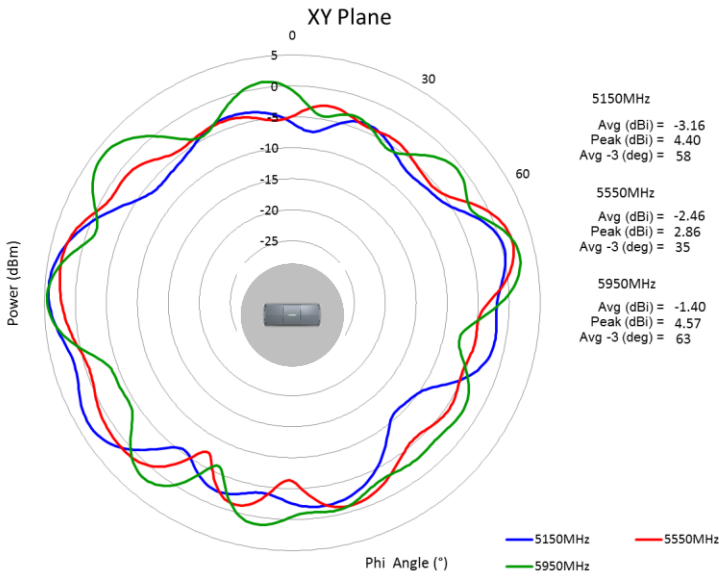

WiFi1 XY plane radiation pattern

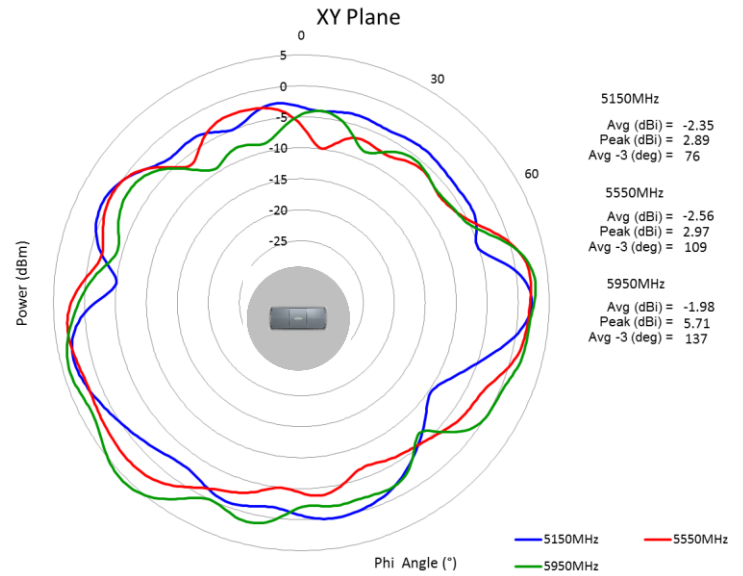

WiFi2 XY plane radiation pattern

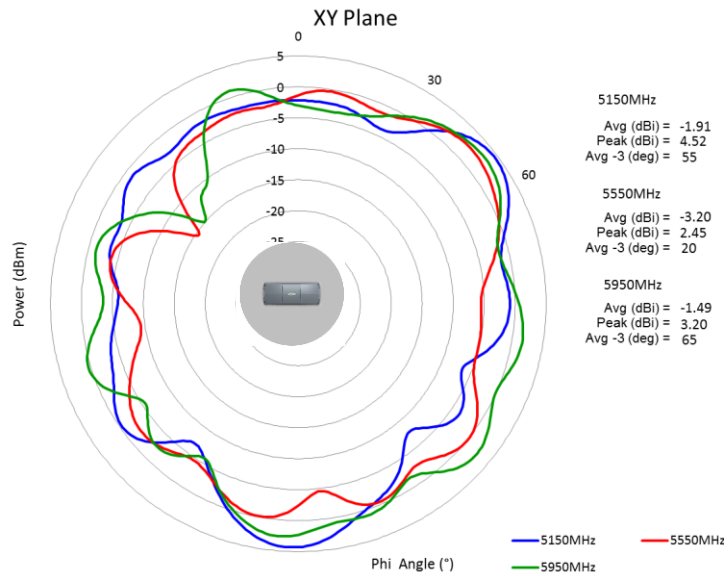

WiFi3 XY plane radiation pattern

Issue: 1901

In the effort to improve our products, we reserve the right to make changes judged to be necessary.

CONFIDENTIAL AND PROPRIETARY INFORMATION

This document contains confidential and proprietary information of Pulse Electronics, Inc. (Pulse) and is protected by copyright, trade secret and other state and federal laws. Its receipt or possession does not convey any rights to reproduce, disclose its contents, or to manufacture, use or sell anything it may describe. Reproduction, disclosure or use without specific written authorization of Pulse is strictly forbidden.

Description: Vehicular Multiband Antenna with Adhesive Mount

Series: ARMADILLO

PART NUMBER: ARMXXXXXAM

CHARTS

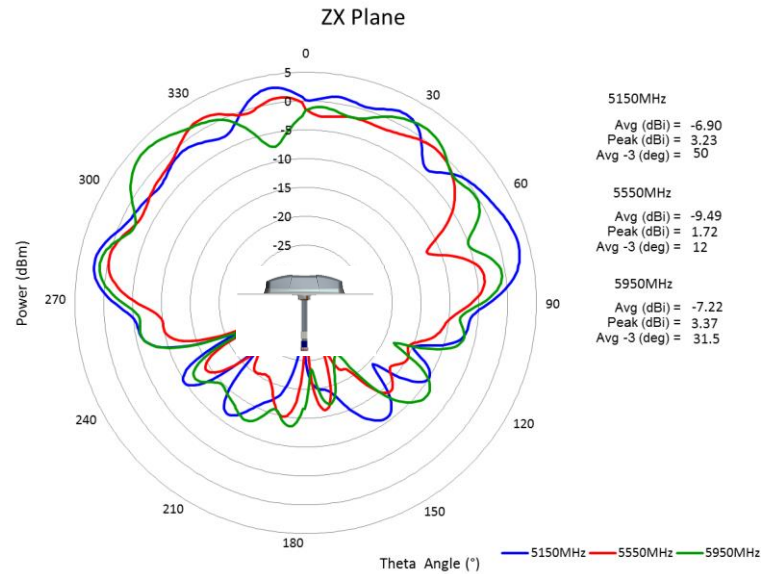
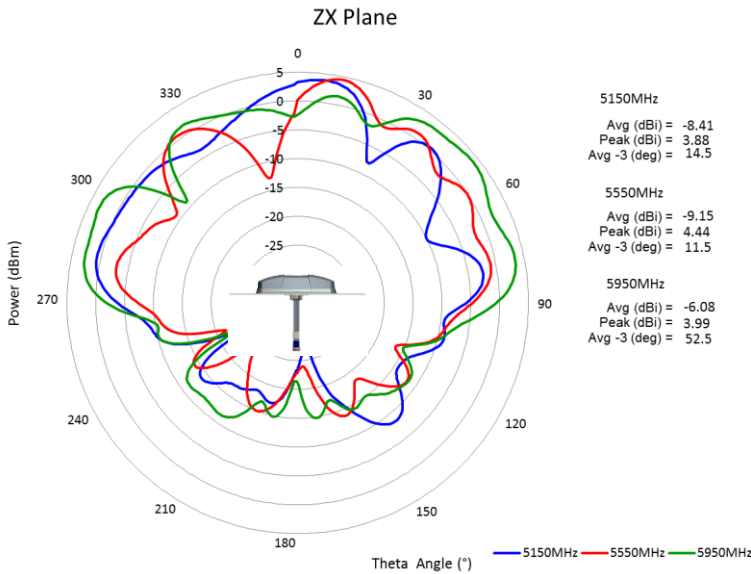

WiFi1 ZX plane radiation pattern

WiFi2 ZX plane radiation pattern

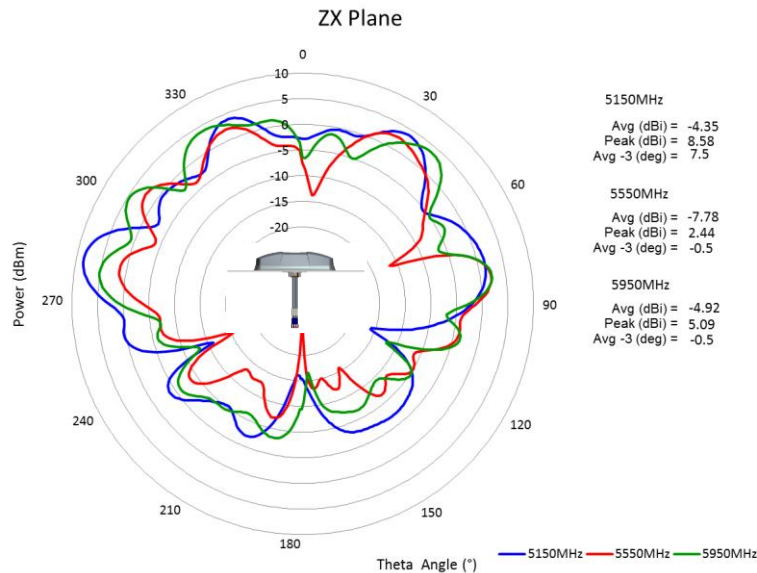

WiFi3 ZX plane radiation pattern

Issue: 1901

In the effort to improve our products, we reserve the right to make changes judged to be necessary.

CONFIDENTIAL AND PROPRIETARY INFORMATION

This document contains confidential and proprietary information of Pulse Electronics, Inc. (Pulse) and is protected by copyright, trade secret and other state and federal laws. Its receipt or possession does not convey any rights to reproduce, disclose its contents, or to manufacture, use or sell anything it may describe. Reproduction, disclosure or use without specific written authorization of Pulse is strictly forbidden.

Description: Vehicular Multiband Antenna with Adhesive Mount

Series: ARMADILLO

PART NUMBER: ARMXXXXXAM

CHARTS

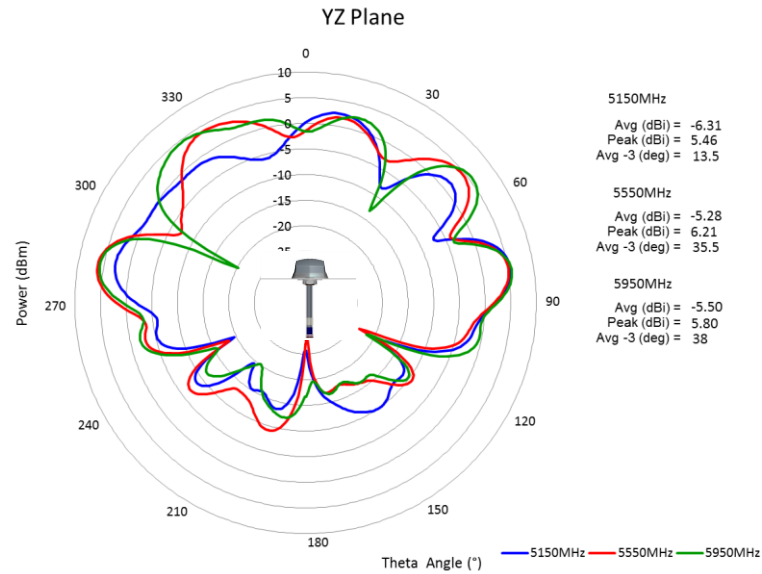
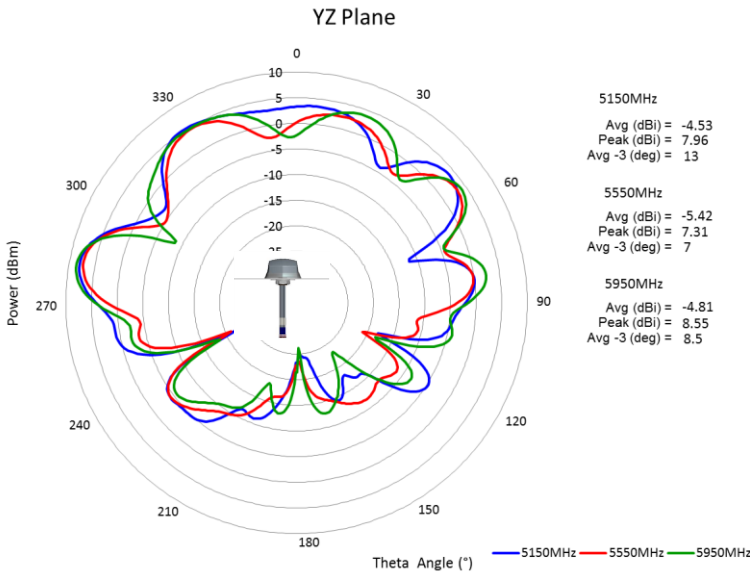

WiFi1 YZ plane radiation pattern

WiFi2 YZ plane radiation pattern

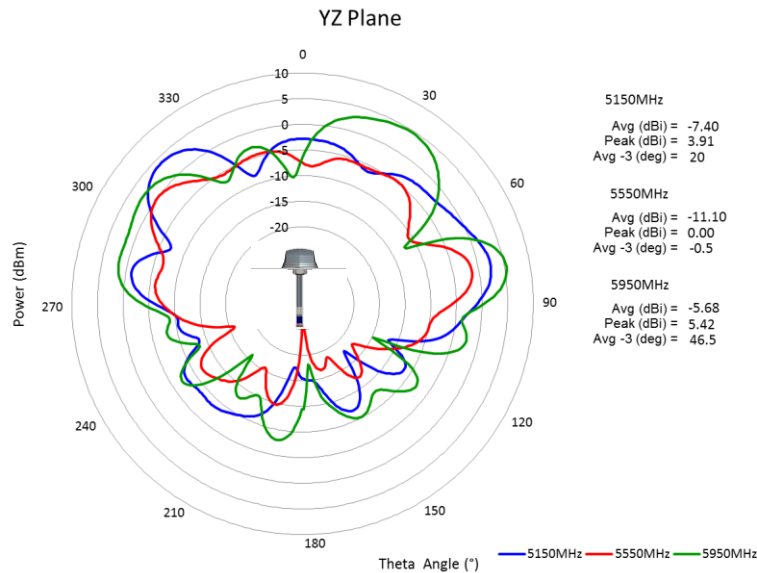

WiFi3 YZ plane radiation pattern

Issue: 1901

In the effort to improve our products, we reserve the right to make changes judged to be necessary.

CONFIDENTIAL AND PROPRIETARY INFORMATION

This document contains confidential and proprietary information of Pulse Electronics, Inc. (Pulse) and is protected by copyright, trade secret and other state and federal laws. Its receipt or possession does not convey any rights to reproduce, disclose its contents, or to manufacture, use or sell anything it may describe. Reproduction, disclosure or use without specific written authorization of Pulse is strictly forbidden.

Series: ARMADILLO

Description: Vehicular Multiband Antenna with Adhesive Mount

PART NUMBER: ARMXXXXXAM

PACKAGING

Each antennas packed in Bubble Bag

6 bags of antennas (Total 6pcs) packed in a cardboard box

1 label on each box with quantity, part number, date code.

单击下面可查看定价，库存，交付和生命周期等信息

[>>Pulse\(普思\)](#)