

Description: 2.4/5GHz Dualband WiFi SMT Antenna

Series: Embedded Antenna

PART NUMBER: W3715



Features:

- Frequency: 2.4-2.5/4.9-6GHz
- Gain: 3.7/5.5dBi
- Size: 11 x 7 x 16 mm
- SMT compatible
- Packing: Tape&Reel
- RoHS compliant

Applications:

- WiFi, ISM 2.4/5GHz
- Bluetooth, Zigbee, BLE
- DSRC 5.925GHz
- IoT and M2M devices
- Portable Electronics
- Security, Transportation

All dimensions are in mm / inches

Issue: 1812

In the effort to improve our products, we reserve the right to make changes judged to be necessary.

CONFIDENTIAL AND PROPRIETARY INFORMATION

This document contains confidential and proprietary information of Pulse Electronics, Inc. (Pulse) and is protected by copyright, trade secret and other state and federal laws. Its receipt or possession does not convey any rights to reproduce, disclose its contents, or to manufacture, use or sell anything it may describe. Reproduction, disclosure or use without specific written authorization of Pulse is strictly forbidden.

For more information:

Pulse Worldwide Headquarters
12220 World Trade Drive
San Diego, CA 92128
USA
Tel: 1-858-674-8100

Pulse/Larsen Antennas
18110 SE 34th St Bldg 2 Suite 250
Vancouver, WA 98683
USA
Tel: 1-360-944-7551

Europe Headquarters
Pulse GmbH & Do, KG
Zeppelinstrasse 15
Herrenberg, Germany

Pulse (Suzhou) Wireless Products Co, Inc.
99 Huo Ju Road(#29 Bldg,4th Phase
Suzhou New District
Jiangsu Province, Suzhou 215009 PR China
Tel: 86 512 6807 9998

Description: 2.4/5GHz Dualband WiFi SMT Antenna

Series: Embedded Antenna

PART NUMBER: W3715

ELECTRICAL SPECIFICATIONS

Frequency	2.4-2.5GHz, 4.9-6GHz
Nominal Impedance	50Ω
VSWR	2:1
Peak Gain (2.4-2.5GHz)	3.7dBi +/- 1 dB
Peak Gain (4.9-6GHz)	5.5dBi +/- 1 dB
Efficiency	74%
Power withstanding	5W
Radiation Pattern	Omni

Issue: 1812

In the effort to improve our products, we reserve the right to make changes judged to be necessary.

CONFIDENTIAL AND PROPRIETARY INFORMATION

This document contains confidential and proprietary information of Pulse Electronics, Inc. (Pulse) and is protected by copyright, trade secret and other state and federal laws. Its receipt or possession does not convey any rights to reproduce, disclose its contents, or to manufacture, use or sell anything it may describe. Reproduction, disclosure or use without specific written authorization of Pulse is strictly forbidden.

Downloaded From Oneyac.com

Description: 2.4/5GHz Dualband WiFi SMT
Antenna

Series: Embedded Antenna

PART NUMBER: W3715

MECHANICAL SPECIFICATIONS

Material	SUS304
Thickness	0.5 mm
Finish	Ni plating 1-3 um
Weight	0.56 g
Size(L X W X H)	11(0.43)X 7(0.28) X 16(0.63) mm(inch)
Fixing system	SMT

ENVIRONMENTAL SPECIFICATIONS

Operating temperature	-40/+85 ° C
-----------------------	-------------

Description: 2.4/5GHz Dualband WiFi SMT Antenna

Series: Embedded Antenna

PART NUMBER: W3715

MECHANICAL DRAWING

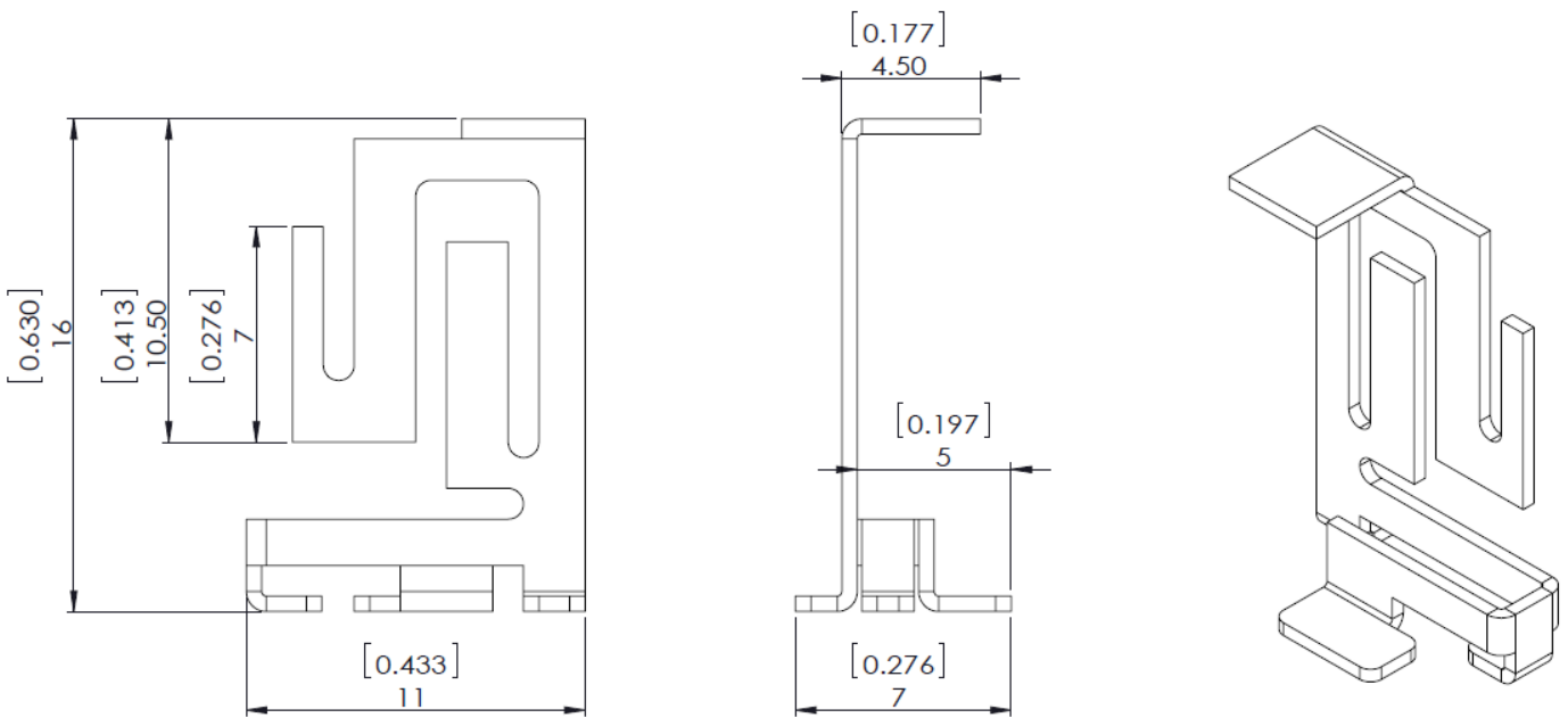

Issue: 1812

In the effort to improve our products, we reserve the right to make changes judged to be necessary.

CONFIDENTIAL AND PROPRIETARY INFORMATION

This document contains confidential and proprietary information of Pulse Electronics, Inc. (Pulse) and is protected by copyright, trade secret and other state and federal laws. Its receipt or possession does not convey any rights to reproduce, disclose its contents, or to manufacture, use or sell anything it may describe. Reproduction, disclosure or use without specific written authorization of Pulse is strictly forbidden.

Description: 2.4/5GHz Dualband WiFi SMT Antenna

Series: Embedded Antenna

PART NUMBER: W3715

OTHER SPECIFICATIONS

PCB LAYOUT:

1, PCB material, FR4, size, 180X120X1mm

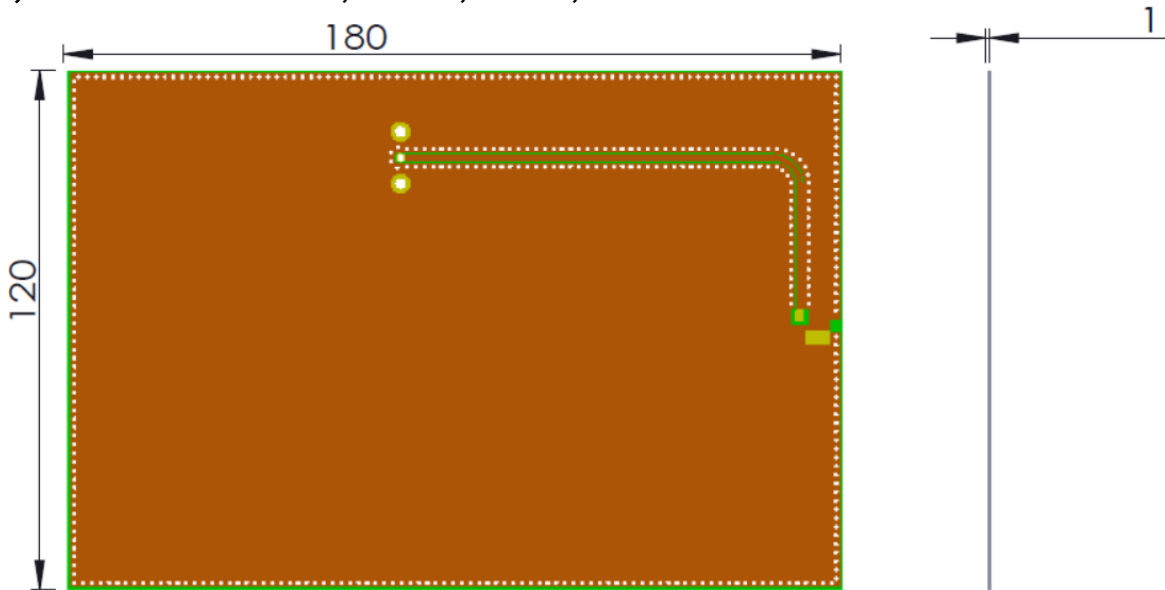

2, Clearance area (Top)

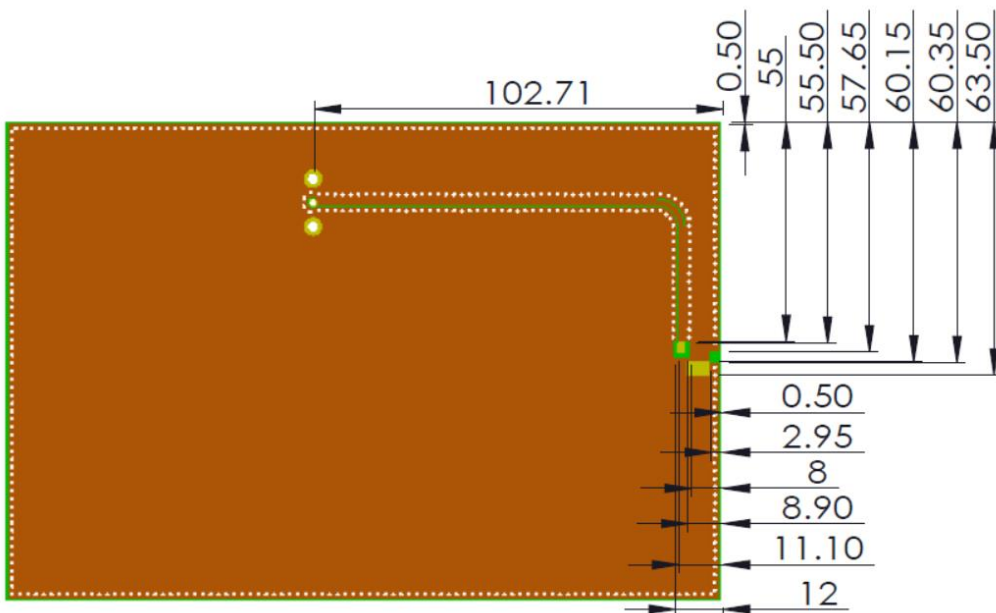

Issue: 1812

In the effort to improve our products, we reserve the right to make changes judged to be necessary.

CONFIDENTIAL AND PROPRIETARY INFORMATION

This document contains confidential and proprietary information of Pulse Electronics, Inc. (Pulse) and is protected by copyright, trade secret and other state and federal laws. Its receipt or possession does not convey any rights to reproduce, disclose its contents, or to manufacture, use or sell anything it may describe. Reproduction, disclosure or use without specific written authorization of Pulse is strictly forbidden.

Description: 2.4/5GHz Dualband WiFi SMT
Antenna

Series: Embedded Antenna

PART NUMBER: W3715

OTHER SPECIFICATIONS

3, Clearance area (Bottom)

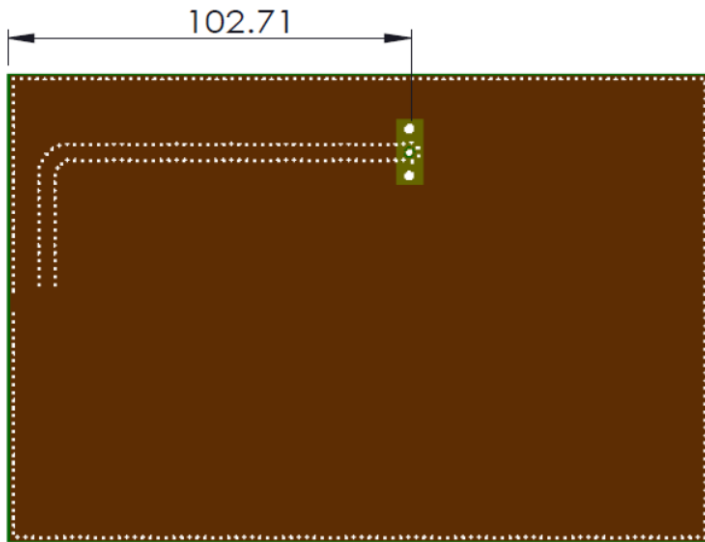

4, PCB Features

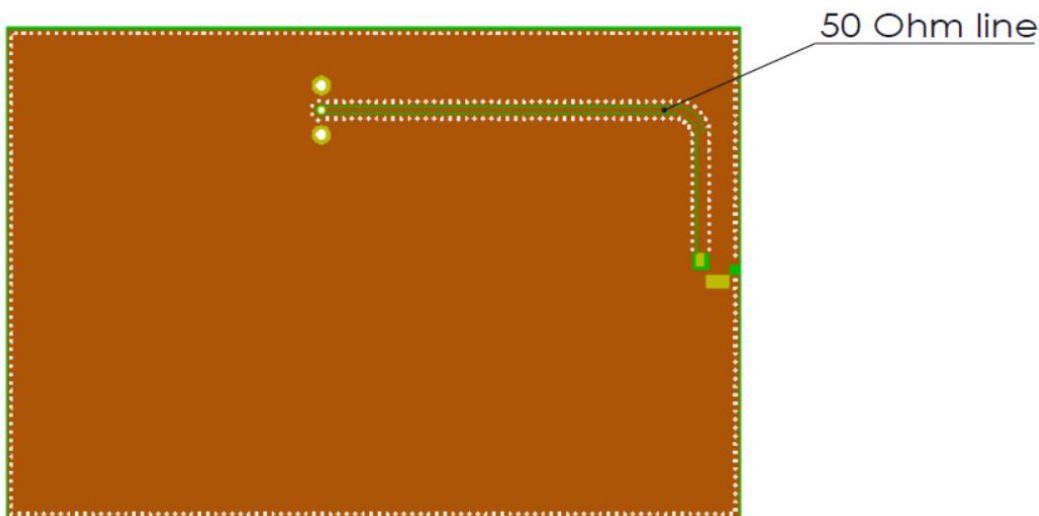

Issue: 1812

In the effort to improve our products, we reserve the right to make changes judged to be necessary.

CONFIDENTIAL AND PROPRIETARY INFORMATION

This document contains confidential and proprietary information of Pulse Electronics, Inc. (Pulse) and is protected by copyright, trade secret and other state and federal laws. Its receipt or possession does not convey any rights to reproduce, disclose its contents, or to manufacture, use or sell anything it may describe. Reproduction, disclosure or use without specific written authorization of Pulse is strictly forbidden.

Description: 2.4/5GHz Dualband WiFi SMT
Antenna

Series: Embedded Antenna

PART NUMBER: W3715

OTHER SPECIFICATIONS

3, Antenna on test PCB

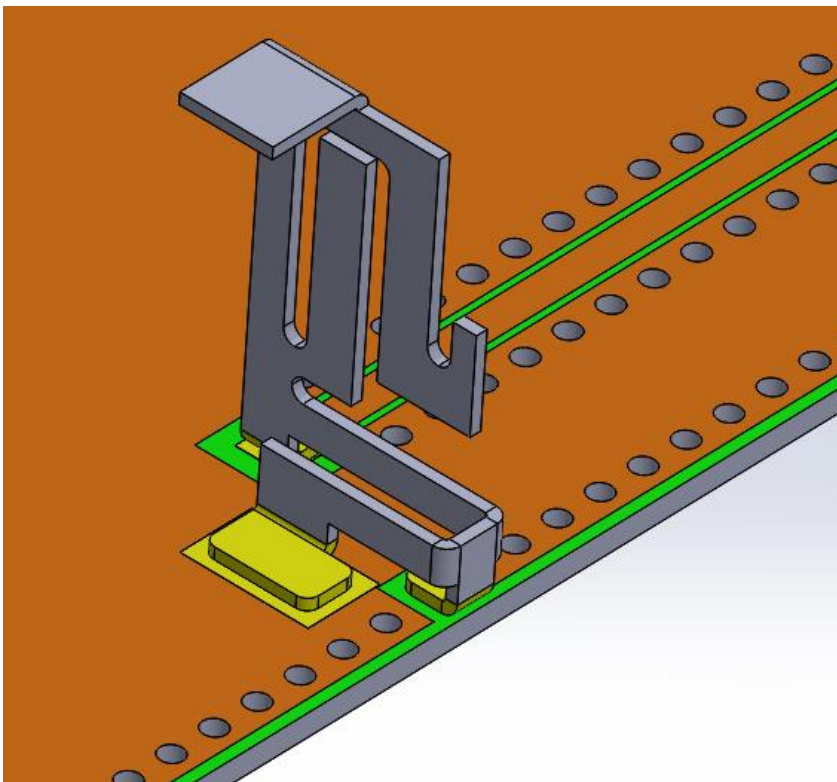
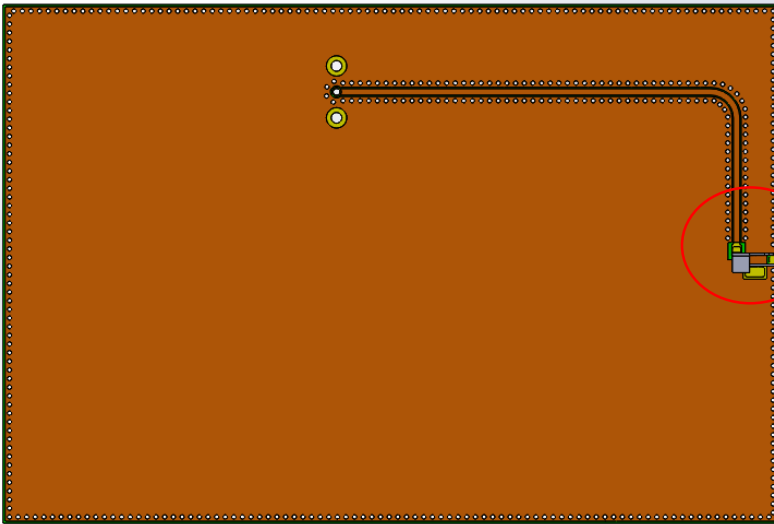

Issue: 1812

In the effort to improve our products, we reserve the right to make changes judged to be necessary.

CONFIDENTIAL AND PROPRIETARY INFORMATION

This document contains confidential and proprietary information of Pulse Electronics, Inc. (Pulse) and is protected by copyright, trade secret and other state and federal laws. Its receipt or possession does not convey any rights to reproduce, disclose its contents, or to manufacture, use or sell anything it may describe. Reproduction, disclosure or use without specific written authorization of Pulse is strictly forbidden.

Downloaded From Oneyac.com

Description: 2.4/5GHz Dualband WiFi SMT Antenna

Series: Embedded Antenna

PART NUMBER: W3715

OTHER SPECIFICATIONS

Recommendation for reflow soldering process

Printing stencil thickness 0,15 - 0,25 mm is recommended for the solder paste. The maximum soldering temperature should not exceed 260°C. The temperature profile recommendations for reflow soldering process is presented in the Figures 1 and 2. The reflow profile

presented in figure 1 describes minimum reflow temperatures. The reflow profile presented in figure 2 describes maximum reflow temperatures. located at the center of the coverage area.

	Method of heat transfer	Controlled hot air convection
1	Average temperature gradient in preheating	2.5 °C/s
2	Soak time	2-3 minutes
3	Max temperature gradient in reflow	3 °C/s
4	Time above 217 °C	Max 30 sec
5	Peak temperature in reflow	230 °C for 10 seconds
6	Temperature gradient in cooling	Max -5 °C/s

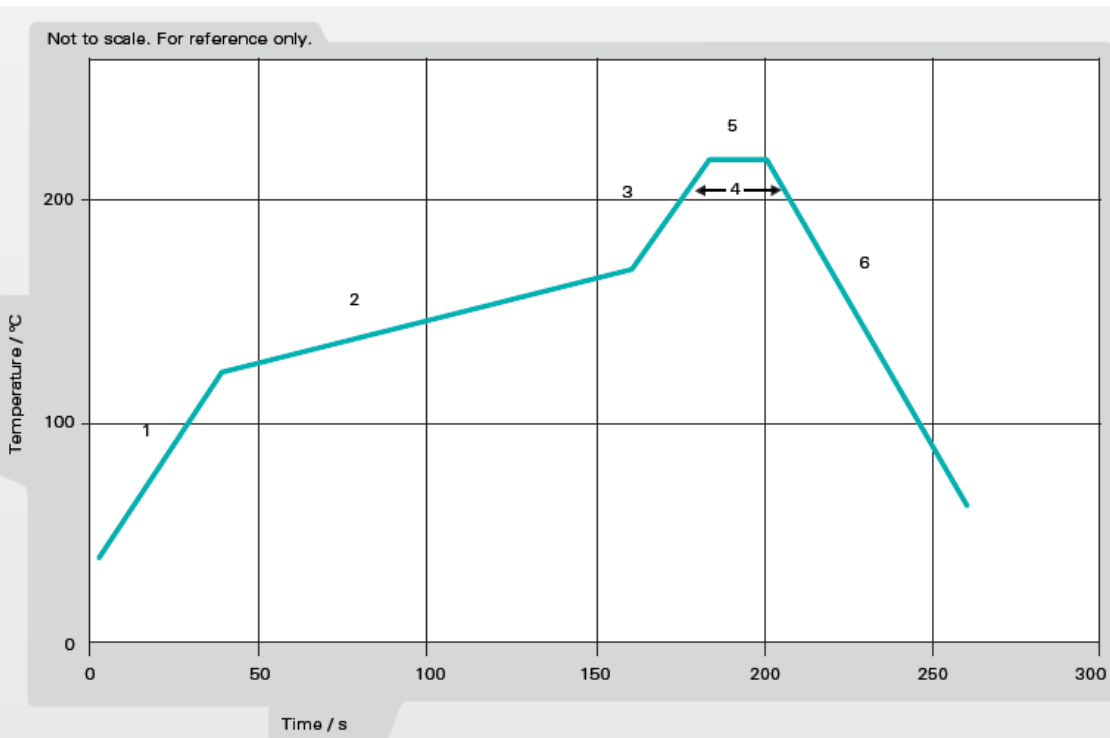

Figure 1. Minimum temperature profile recommendation for reflow soldering process

Issue: 1812

In the effort to improve our products, we reserve the right to make changes judged to be necessary.

CONFIDENTIAL AND PROPRIETARY INFORMATION

This document contains confidential and proprietary information of Pulse Electronics, Inc. (Pulse) and is protected by copyright, trade secret and other state and federal laws. Its receipt or possession does not convey any rights to reproduce, disclose its contents, or to manufacture, use or sell anything it may describe. Reproduction, disclosure or use without specific written authorization of Pulse is strictly forbidden.

Description: 2.4/5GHz Dualband WiFi SMT Antenna

Series: Embedded Antenna

PART NUMBER: W3715

OTHER SPECIFICATIONS

	Method of heat transfer	Controlled hot air convection
1	Average temperature gradient in preheating	2.5 °C/s
2	Soak time	2-3 minutes
3	Max temperature gradient in reflow	3 °C/s
4	Time above 217 °C	Max 60 sec
5	Time above 230 °C	Max 50 sec
6	Time above 250 °C	Max 10 sec
7	Peak temperature in reflow	260 °C for 5 seconds
8	Temperature gradient in cooling	Max -5 °C/s

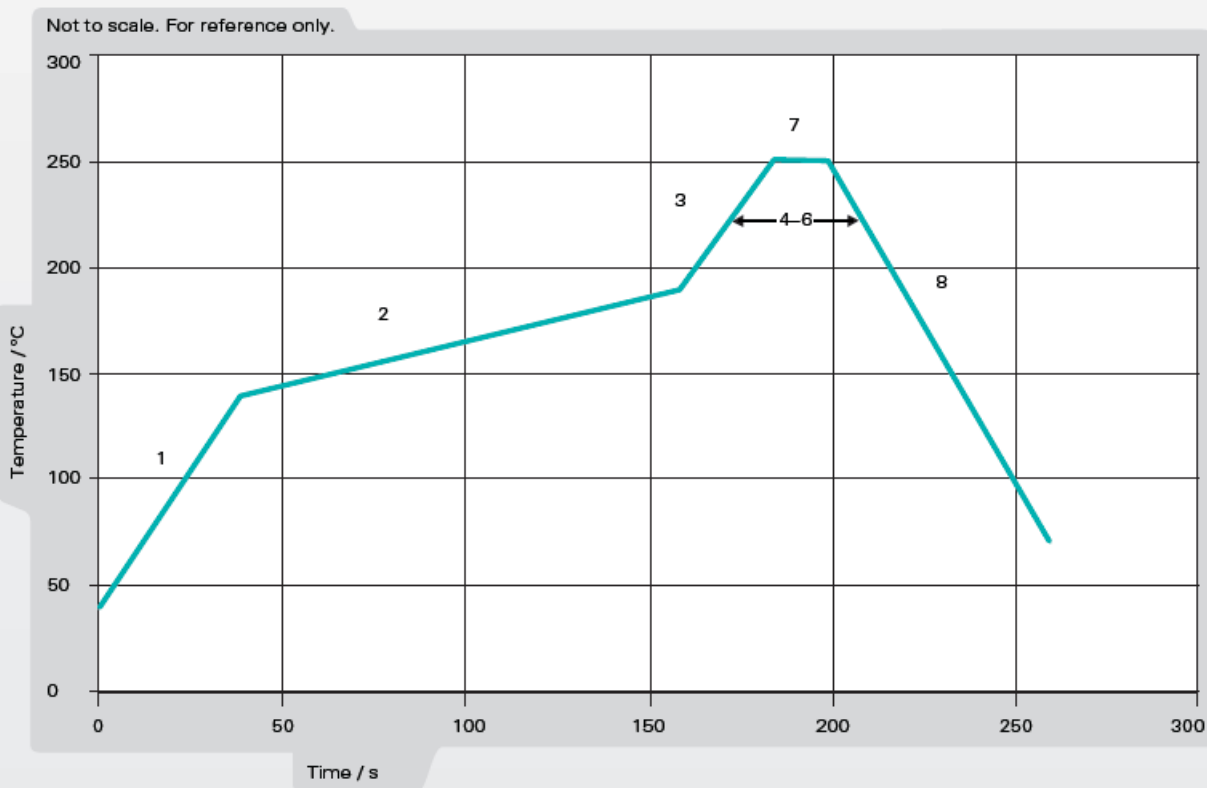

Figure 2. Maximum temperature profile recommendation for reflow soldering process

Issue: 1812

In the effort to improve our products, we reserve the right to make changes judged to be necessary.

CONFIDENTIAL AND PROPRIETARY INFORMATION

This document contains confidential and proprietary information of Pulse Electronics, Inc. (Pulse) and is protected by copyright, trade secret and other state and federal laws. Its receipt or possession does not convey any rights to reproduce, disclose its contents, or to manufacture, use or sell anything it may describe. Reproduction, disclosure or use without specific written authorization of Pulse is strictly forbidden.

Description: 2.4/5GHz Dualband WiFi SMT Antenna

Series: Embedded Antenna

PART NUMBER: W3715

CHARTS

VSWR

VSWR

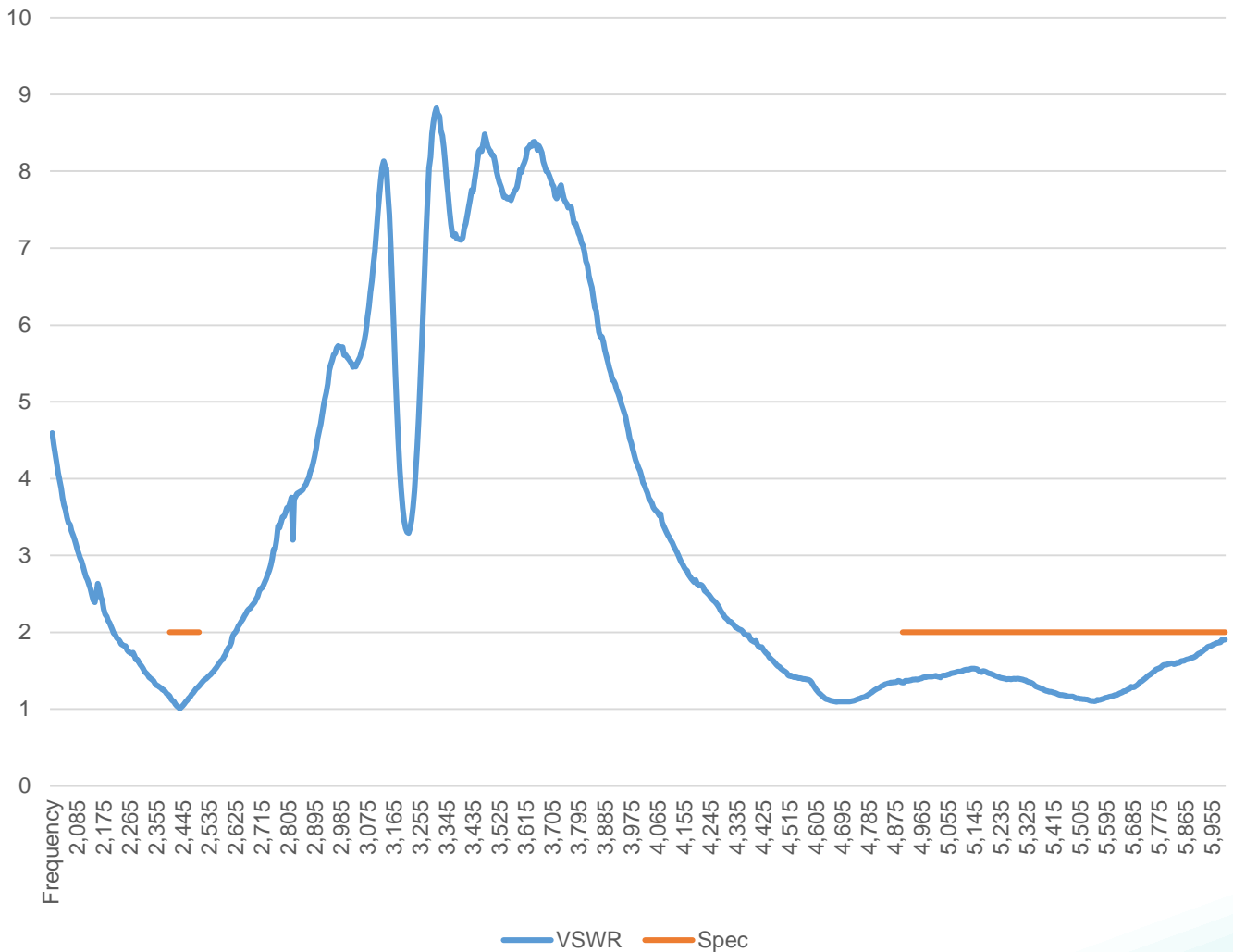

Issue: 1812

In the effort to improve our products, we reserve the right to make changes judged to be necessary.

CONFIDENTIAL AND PROPRIETARY INFORMATION

This document contains confidential and proprietary information of Pulse Electronics, Inc. (Pulse) and is protected by copyright, trade secret and other state and federal laws. Its receipt or possession does not convey any rights to reproduce, disclose its contents, or to manufacture, use or sell anything it may describe. Reproduction, disclosure or use without specific written authorization of Pulse is strictly forbidden.

Description: 2.4/5GHz Dualband WiFi SMT Antenna

Series: Embedded Antenna

PART NUMBER: W3715

CHARTS

Efficiency(%)

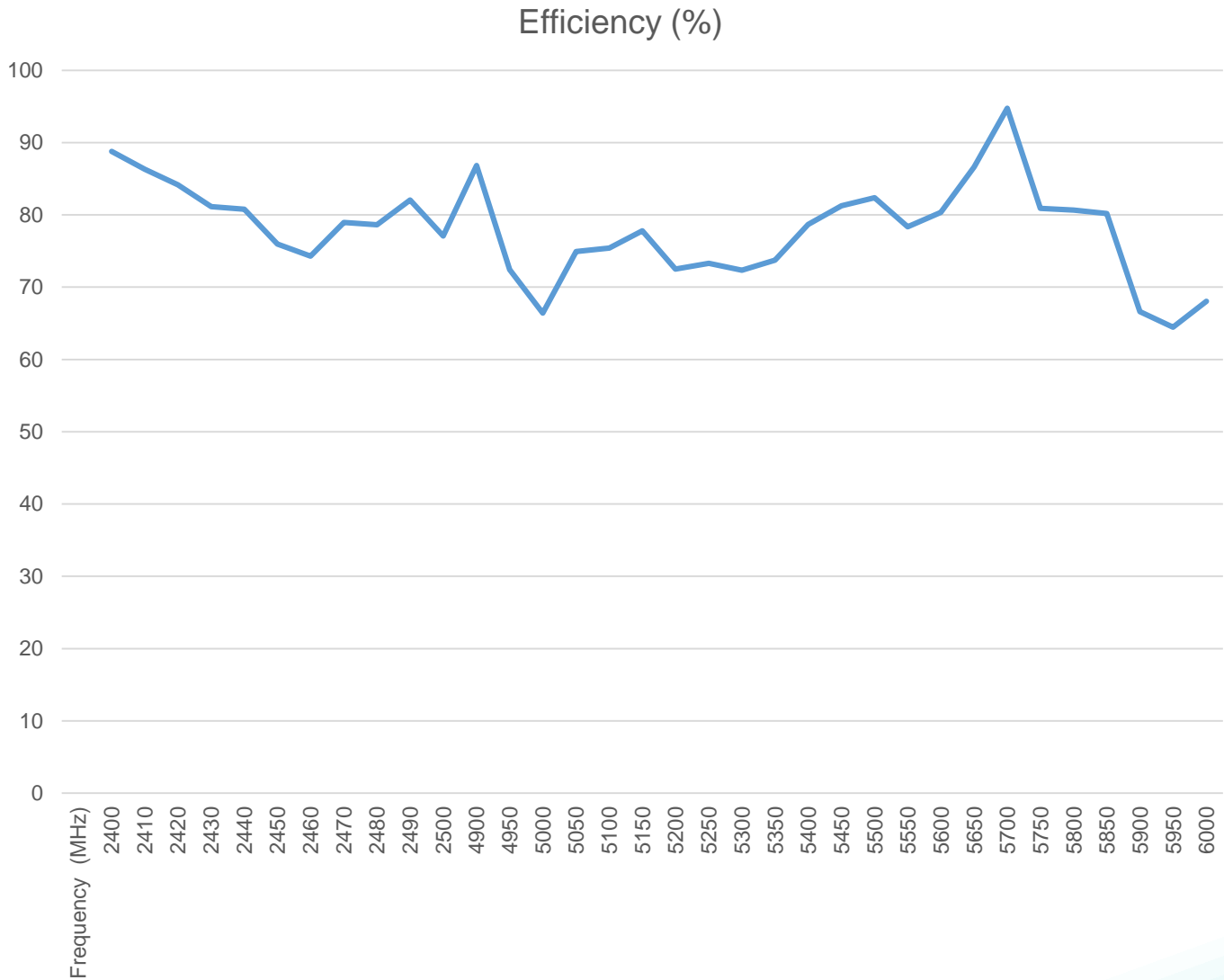

Issue: 1812

In the effort to improve our products, we reserve the right to make changes judged to be necessary.

CONFIDENTIAL AND PROPRIETARY INFORMATION

This document contains confidential and proprietary information of Pulse Electronics, Inc. (Pulse) and is protected by copyright, trade secret and other state and federal laws. Its receipt or possession does not convey any rights to reproduce, disclose its contents, or to manufacture, use or sell anything it may describe. Reproduction, disclosure or use without specific written authorization of Pulse is strictly forbidden.

Description: 2.4/5GHz Dualband WiFi SMT Antenna

Series: Embedded Antenna

PART NUMBER: W3715

CHARTS

Peak Gain (dBi)

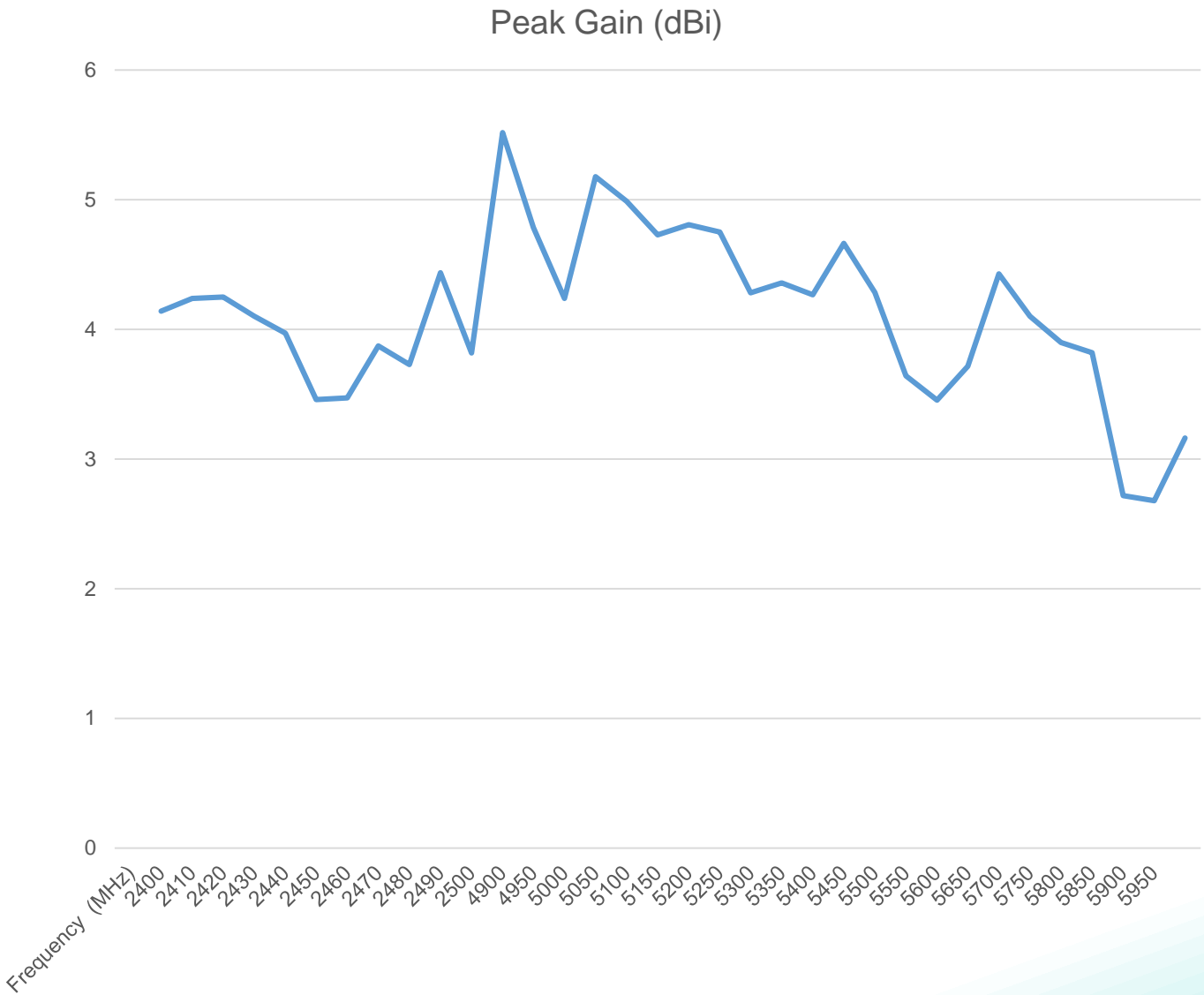

Issue: 1812

In the effort to improve our products, we reserve the right to make changes judged to be necessary.

CONFIDENTIAL AND PROPRIETARY INFORMATION

This document contains confidential and proprietary information of Pulse Electronics, Inc. (Pulse) and is protected by copyright, trade secret and other state and federal laws. Its receipt or possession does not convey any rights to reproduce, disclose its contents, or to manufacture, use or sell anything it may describe. Reproduction, disclosure or use without specific written authorization of Pulse is strictly forbidden.

Description: 2.4/5GHz Dualband WiFi SMT Antenna

Series: Embedded Antenna

PART NUMBER: W3715

CHARTS

Free Space Radiation Pattern

Elevation Plane

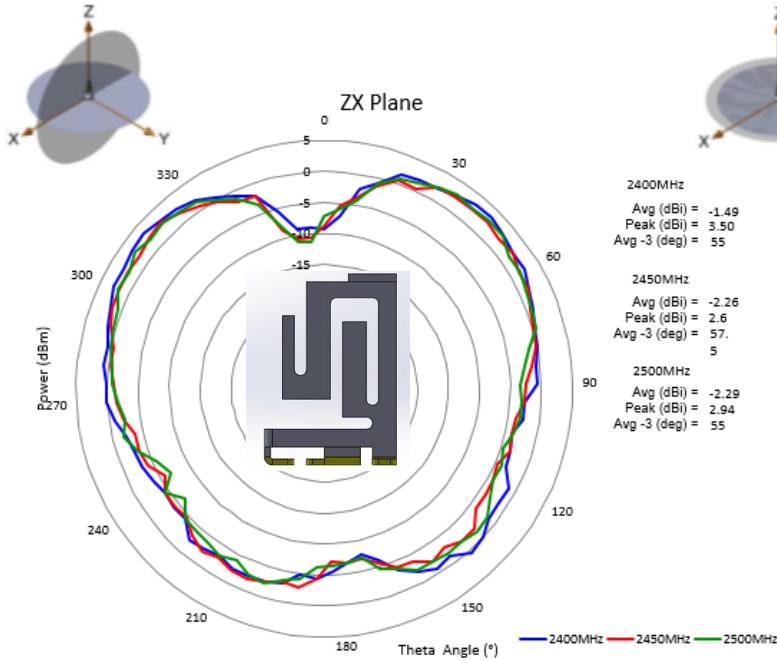

Horizontal Plane

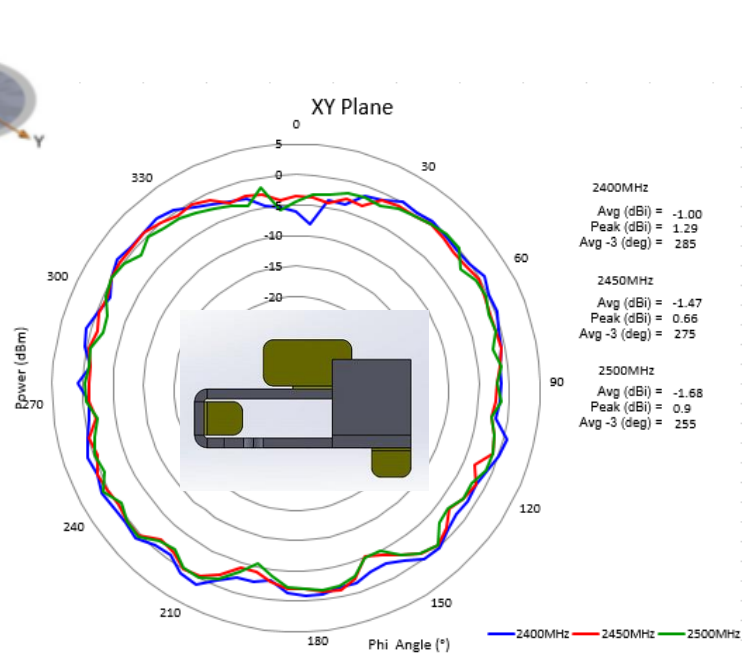

Issue: 1812

In the effort to improve our products, we reserve the right to make changes judged to be necessary.

CONFIDENTIAL AND PROPRIETARY INFORMATION

This document contains confidential and proprietary information of Pulse Electronics, Inc. (Pulse) and is protected by copyright, trade secret and other state and federal laws. Its receipt or possession does not convey any rights to reproduce, disclose its contents, or to manufacture, use or sell anything it may describe. Reproduction, disclosure or use without specific written authorization of Pulse is strictly forbidden.

Description: 2.4/5GHz Dualband WiFi SMT Antenna

Series: Embedded Antenna

PART NUMBER: W3715

CHARTS

Free Space Radiation Pattern

Elevation Plane

Horizontal Plane

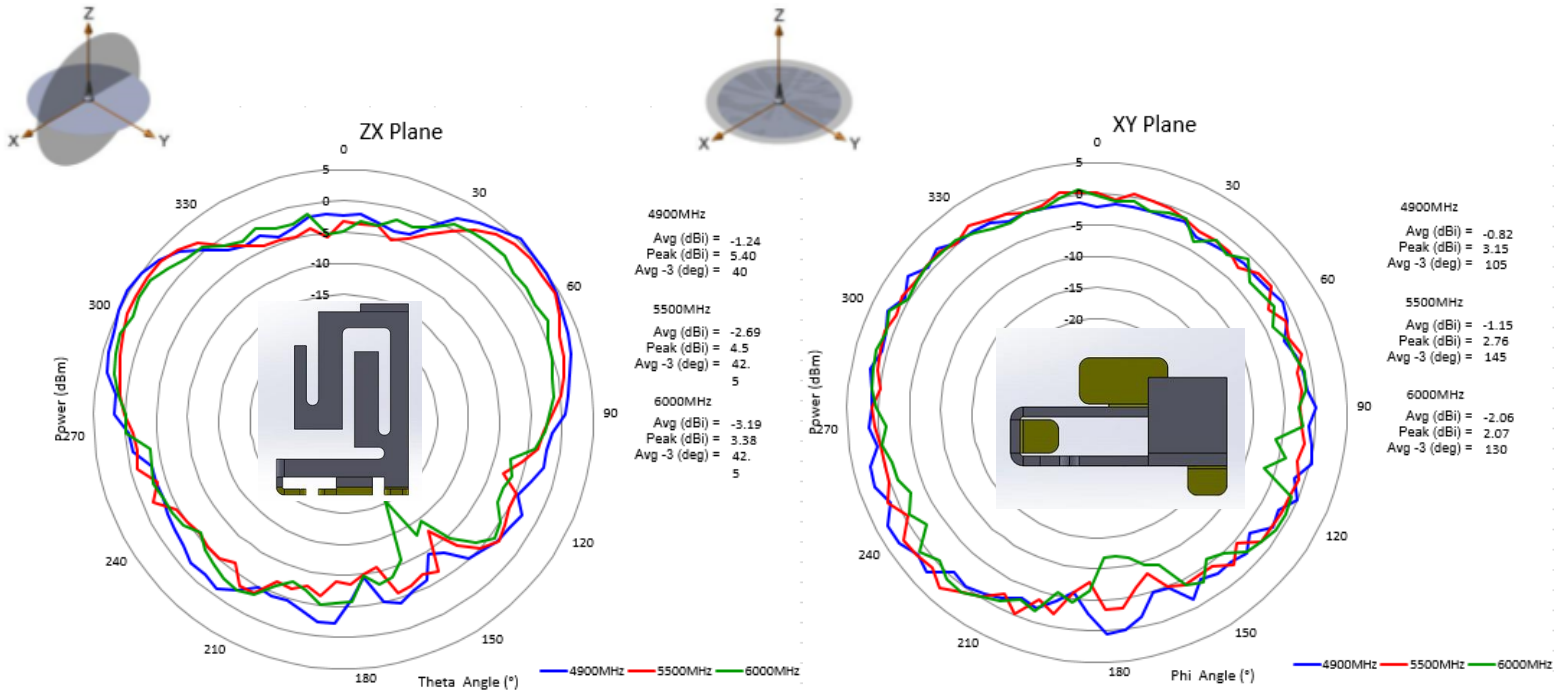

Issue: 1812

In the effort to improve our products, we reserve the right to make changes judged to be necessary.

CONFIDENTIAL AND PROPRIETARY INFORMATION

This document contains confidential and proprietary information of Pulse Electronics, Inc. (Pulse) and is protected by copyright, trade secret and other state and federal laws. Its receipt or possession does not convey any rights to reproduce, disclose its contents, or to manufacture, use or sell anything it may describe. Reproduction, disclosure or use without specific written authorization of Pulse is strictly forbidden.

Description: 2.4/5GHz Dualband WiFi SMT Antenna

Series: Embedded Antenna

PART NUMBER: W3715

PACKAGING

Tape and Reel packing:
200 PCS/ Tape and Reel
400PCS/ Carton box

Tape Width : 32mm
Tape Material : Polystyrene



Issue: 1812

In the effort to improve our products, we reserve the right to make changes judged to be necessary.

CONFIDENTIAL AND PROPRIETARY INFORMATION

This document contains confidential and proprietary information of Pulse Electronics, Inc. (Pulse) and is protected by copyright, trade secret and other state and federal laws. Its receipt or possession does not convey any rights to reproduce, disclose its contents, or to manufacture, use or sell anything it may describe. Reproduction, disclosure or use without specific written authorization of Pulse is strictly forbidden.

Downloaded From Oneyac.com

单击下面可查看定价，库存，交付和生命周期等信息

[>>Pulse\(普思\)](#)