



Features:

- 2400-2483.5MHz
- Size: 3.2 x 1.6 x 1.1mm
- Efficiency: 68 %
- Gain: 1.3 dBi
- Polarization: Linear
- Power Handling: 5W
- RoHS Compliant
- Moisture Sensitivity Level MSL3

Applications:

- Bluetooth, BLE, Zigbee, WiFi
- 2.4GHz ISM band radios

All dimensions are in mm / inches

Issue: 1823

In the effort to improve our products, we reserve the right to make changes judged to be necessary.

CONFIDENTIAL AND PROPRIETARY INFORMATION

This document contains confidential and proprietary information of Pulse Electronics, Inc. (Pulse) and is protected by copyright, trade secret and other state and federal laws. Its receipt or possession does not convey any rights to reproduce, disclose its contents, or to manufacture, use or sell anything it may describe. Reproduction, disclosure or use without specific written authorization of Pulse is strictly forbidden.

For more information:

Pulse Worldwide Headquarters
15255 Innovation Drive #100
San Diego, CA 92128
USA
Tel: 1-858-674-8100

Pulse/Larsen Antennas
18110 SE 34th St Bldg 2 Suite 250
Vancouver, WA 98683
USA
Tel: 1-360-944-7551

Europe Headquarters
Pulse GmbH & Do, KG
Zeppelinstrasse 15
Herrenberg, Germany

Pulse (Suzhou) Wireless Products Co, Inc.
99 Huo Ju Road(#29 Bldg,4th Phase
Suzhou New District
Jiangsu Province, Suzhou 215009 PR China
Tel: 86 512 6807 9998

Description: 2.4-2.4835GHz Ceramic SMT antenna, 4x6.25mm keep out area

Series: Chip Antenna

PART NUMBER: W3008C

ELECTRICAL SPECIFICATIONS

Frequency	2400-2483.5MHz
Nominal Impedance	50 Ω
Return Loss	-8dB
Radiation Pattern	Omni
Gain	1.3dBi
Efficiency	68%
Polarization	Linear
Power Withstanding	5W

MECHANICAL SPECIFICATIONS

Overall Length	3.2x1.6x1.1mm
Weight	33mg
Antenna Color / Material	Ceramic

ENVIRONMENTAL SPECIFICATIONS

Operating Temperature	-40~+85° C
Storage Temperature	-40~+85° C
RoHS Compliant	Yes

(*) All RF parameters measured on 80*37mm PCB with 4*6.25mm clearance in free space. No matching component used.

Issue: 1823

In the effort to improve our products, we reserve the right to make changes judged to be necessary.

CONFIDENTIAL AND PROPRIETARY INFORMATION

This document contains confidential and proprietary information of Pulse Electronics, Inc. (Pulse) and is protected by copyright, trade secret and other state and federal laws. Its receipt or possession does not convey any rights to reproduce, disclose its contents, or to manufacture, use or sell anything it may describe. Reproduction, disclosure or use without specific written authorization of Pulse is strictly forbidden.

Downloaded From Oneyac.com

MECHANICAL DRAWING

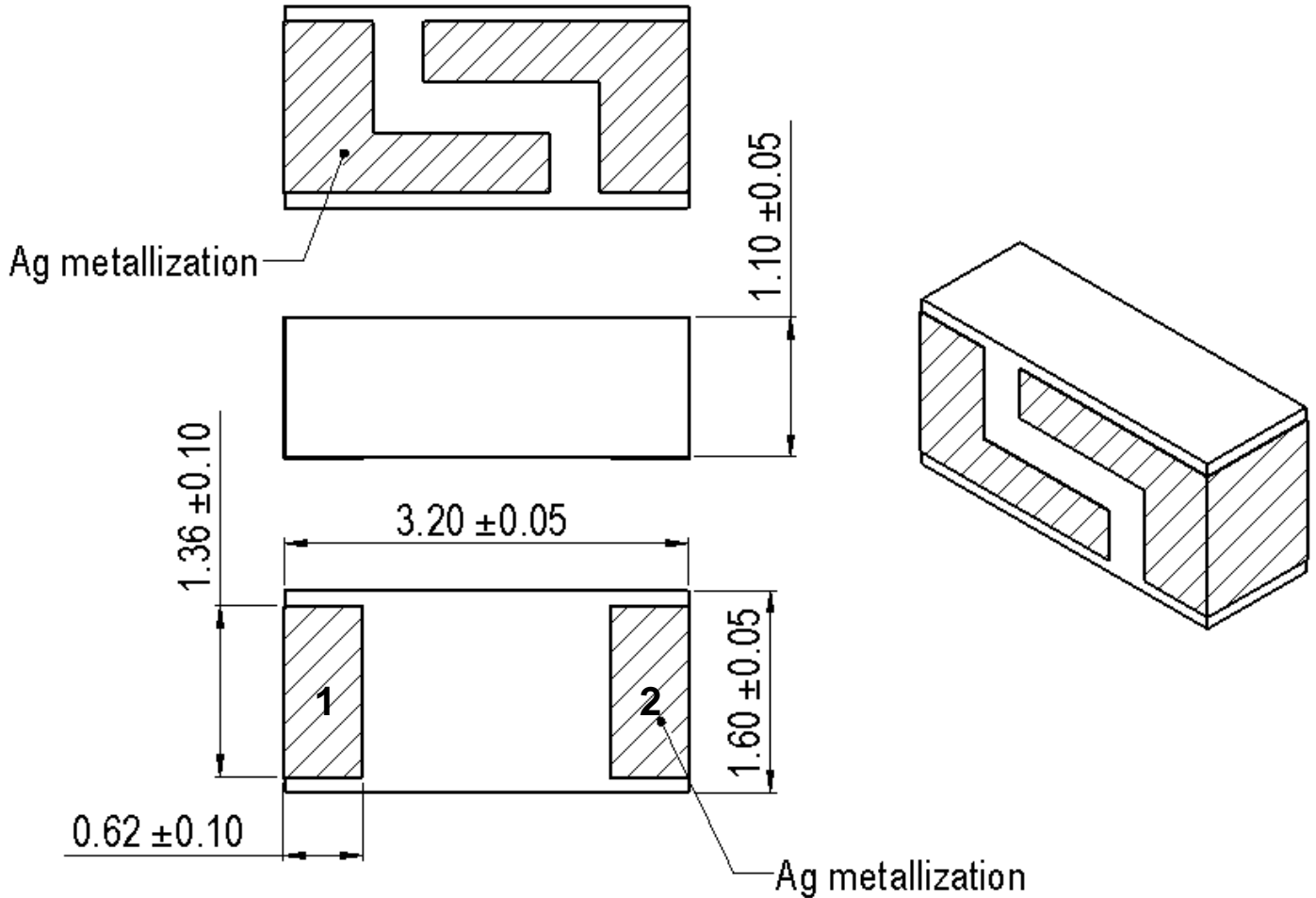

No.	Terminal Name	Terminal Dimensions
1	Feed /GND	0.62 x 1.36 mm
2	Feed /GND	0.62 x 1.36 mm

Antenna is symmetrical, either one of pads 1 or 2 can be used as feed terminal

MECHANICAL DRAWING AND TERMINAL CONFIGURATION

Ground cleared under antenna, clearance area 4 mm x 6.25mm

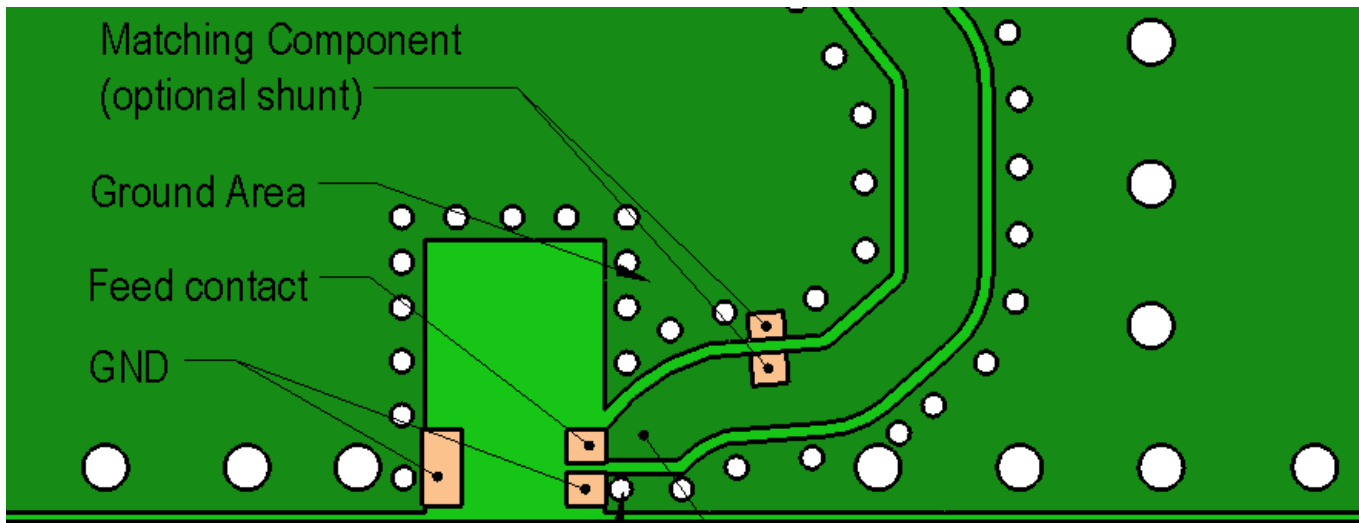

Ground Via Hole
Ground area should be surround with ground via holes

Feed line 50Ohm
Any type of 50 Ohm feed line can be used. inner layers on feed line area need to designed to give 50 Ohm characteristics to feed line.

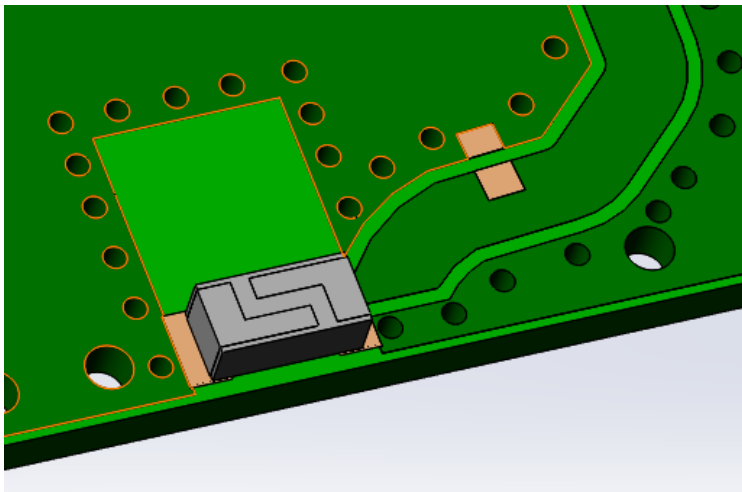

Issue: 1823

In the effort to improve our products, we reserve the right to make changes judged to be necessary.

CONFIDENTIAL AND PROPRIETARY INFORMATION

This document contains confidential and proprietary information of Pulse Electronics, Inc. (Pulse) and is protected by copyright, trade secret and other state and federal laws. Its receipt or possession does not convey any rights to reproduce, disclose its contents, or to manufacture, use or sell anything it may describe. Reproduction, disclosure or use without specific written authorization of Pulse is strictly forbidden.

Description: 2.4-2.4835GHz Ceramic SMT antenna, 4x6.25mm keep out area

Series: Chip Antenna

PART NUMBER: W3008C

MECHANICAL DRAWING AND TERMINAL CONFIGURATION

*Recommended Antenna Pad Dimensions on PCB Layout (top surface)
Ground cleared under antenna, clearance area 4 mm x 6.25 mm*

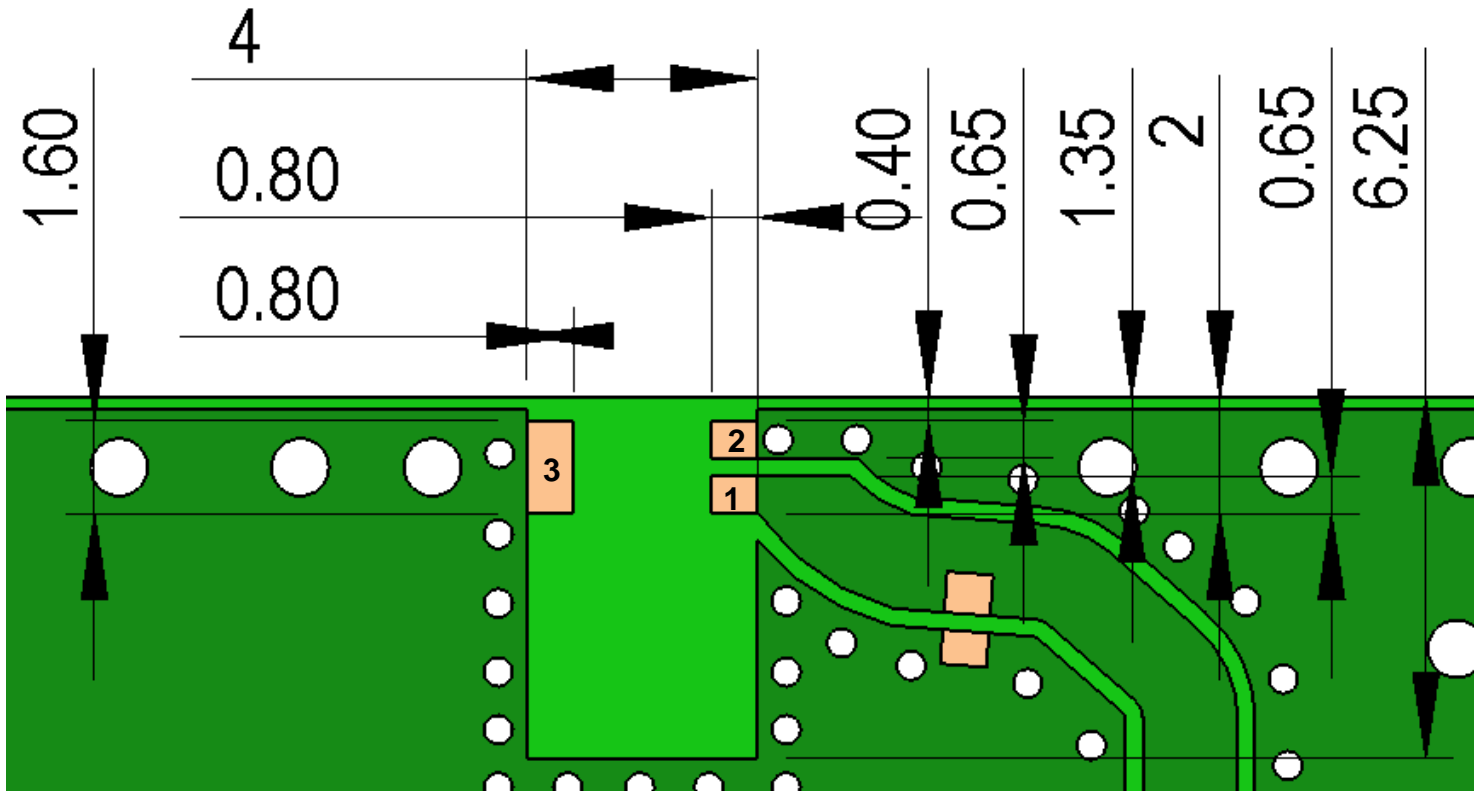

PCB contact pads

No.	Terminal Name	Terminal Dimensions
1	Feed	0,80 x 0,65 mm
2	GND	0,80 x 0,65 mm
3	GND	0,80 x 1,60 mm

MECHANICAL DRAWING AND TERMINAL CONFIGURATION

*Recommended Antenna Pad Dimensions on PCB Layout (bottom surface)
Ground cleared under antenna, clearance area 4 mm x 6.25 mm*

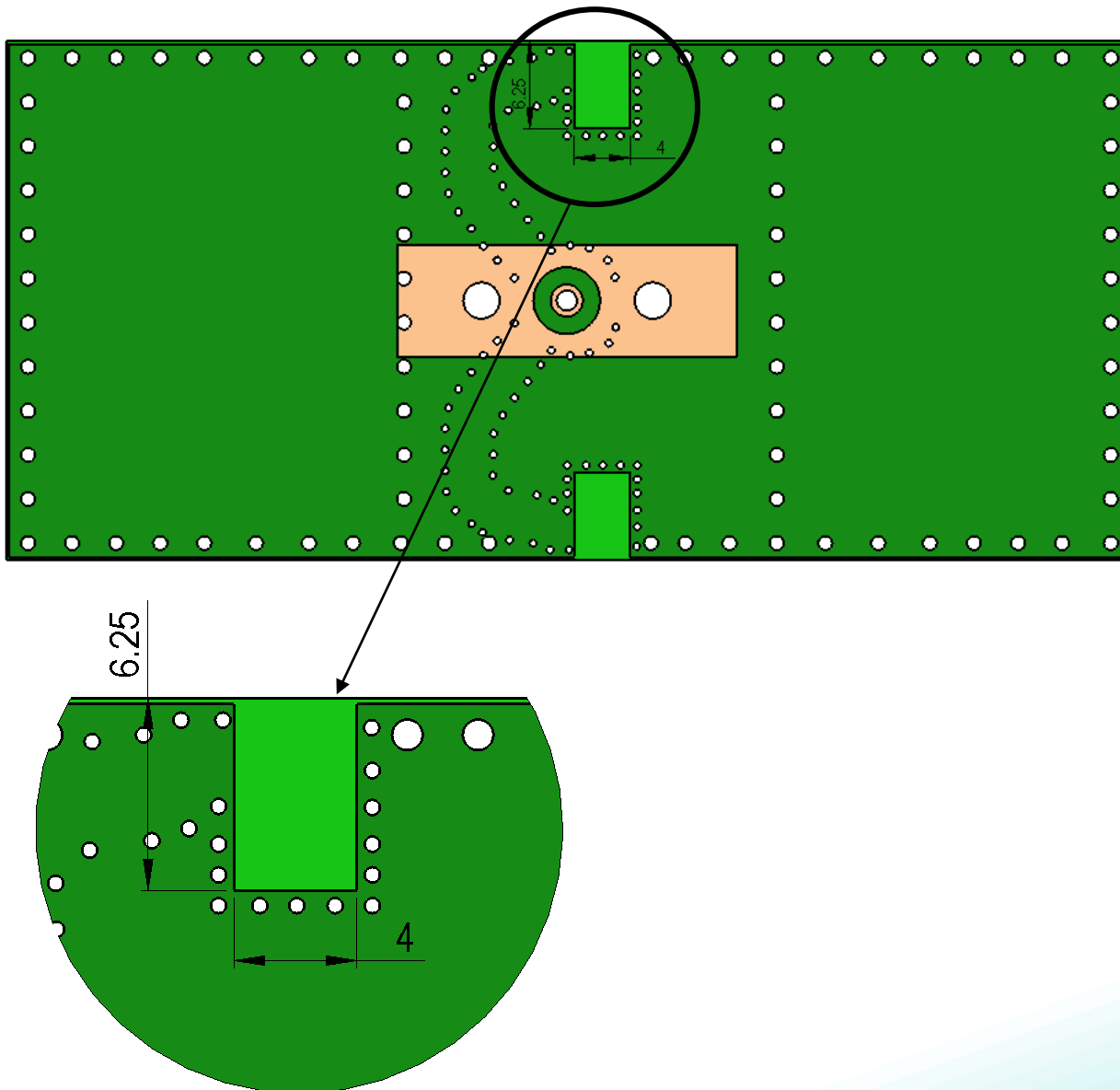

MECHANICAL DRAWING AND TERMINAL CONFIGURATION

Recommended test board layout for electrical characteristic measurement, test board outline size 80 x 37mm

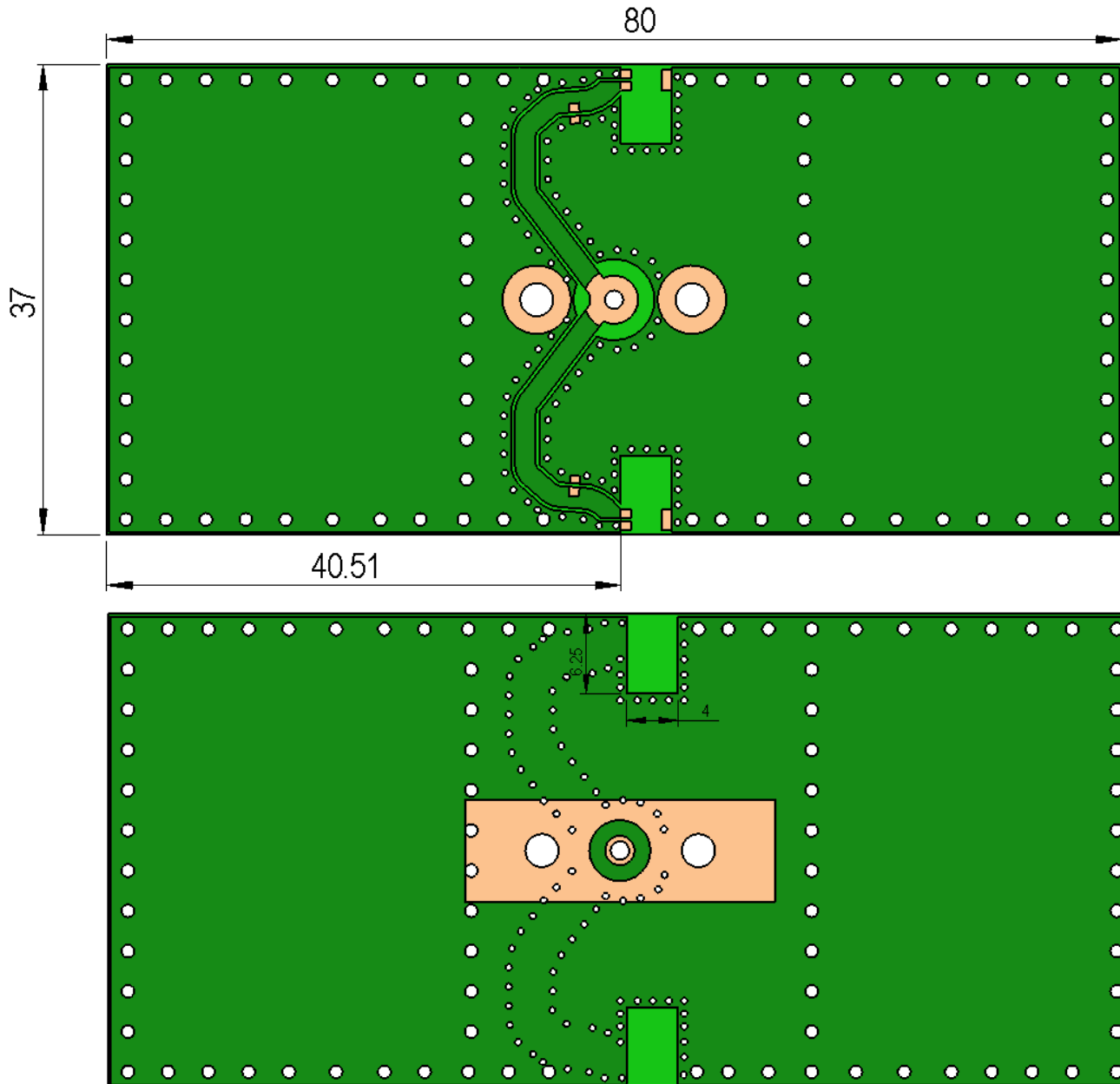

Issue: 1823

In the effort to improve our products, we reserve the right to make changes judged to be necessary.

CONFIDENTIAL AND PROPRIETARY INFORMATION

This document contains confidential and proprietary information of Pulse Electronics, Inc. (Pulse) and is protected by copyright, trade secret and other state and federal laws. Its receipt or possession does not convey any rights to reproduce, disclose its contents, or to manufacture, use or sell anything it may describe. Reproduction, disclosure or use without specific written authorization of Pulse is strictly forbidden.

Description: 2.4-2.4835GHz Ceramic SMT antenna, 4x6.25mm keep out area

Series: Chip Antenna

PART NUMBER: W3008C

CHARTS

Return loss

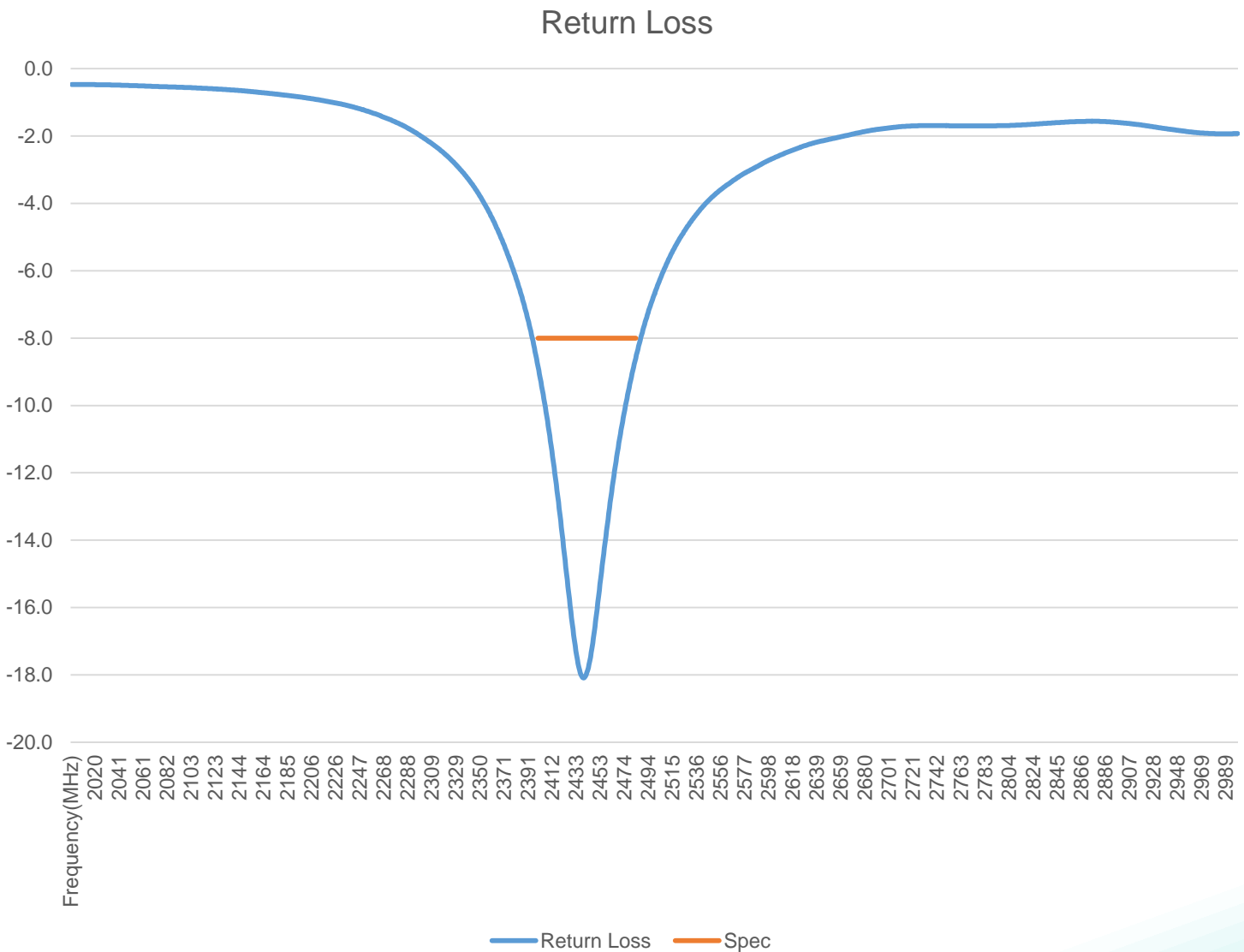

(*) All RF parameters measured on 80*37mm PCB with 4*6.25mm clearance in free space. No matching component used.

Issue: 1823

In the effort to improve our products, we reserve the right to make changes judged to be necessary.

CONFIDENTIAL AND PROPRIETARY INFORMATION

This document contains confidential and proprietary information of Pulse Electronics, Inc. (Pulse) and is protected by copyright, trade secret and other state and federal laws. Its receipt or possession does not convey any rights to reproduce, disclose its contents, or to manufacture, use or sell anything it may describe. Reproduction, disclosure or use without specific written authorization of Pulse is strictly forbidden.

Description: 2.4-2.4835GHz Ceramic SMT antenna, 4x6.25mm keep out area

Series: Chip Antenna

PART NUMBER: W3008C

CHARTS

Efficiency(%)

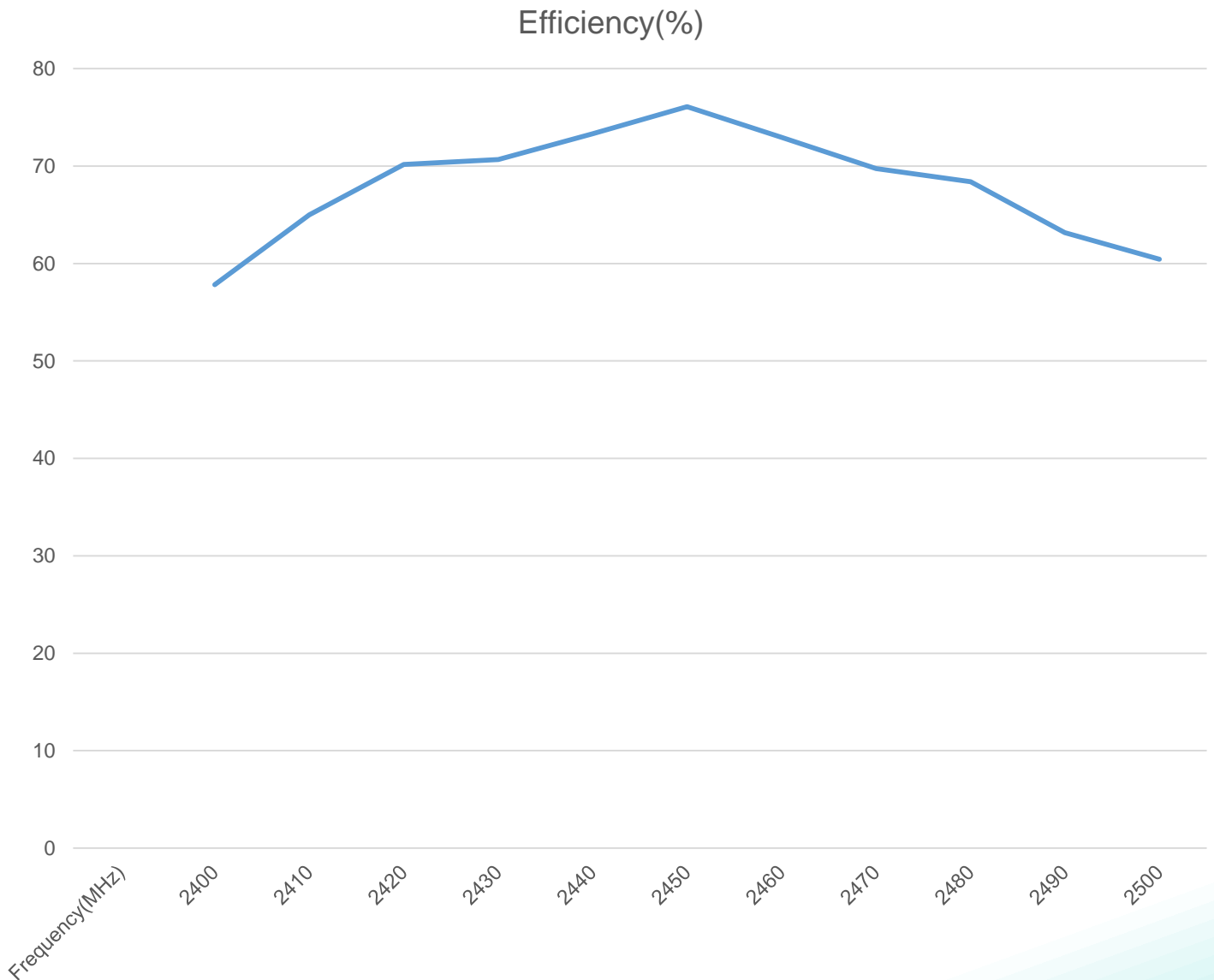

(*) All RF parameters measured on 80*37mm PCB with 4*6.25mm clearance in free space. No matching component used.

Issue: 1823

In the effort to improve our products, we reserve the right to make changes judged to be necessary.

CONFIDENTIAL AND PROPRIETARY INFORMATION

This document contains confidential and proprietary information of Pulse Electronics, Inc. (Pulse) and is protected by copyright, trade secret and other state and federal laws. Its receipt or possession does not convey any rights to reproduce, disclose its contents, or to manufacture, use or sell anything it may describe. Reproduction, disclosure or use without specific written authorization of Pulse is strictly forbidden.

Description: 2.4-2.4835GHz Ceramic SMT antenna, 4x6.25mm keep out area

Series: Chip Antenna

PART NUMBER: W3008C

CHARTS

Peak Gain(dBi)

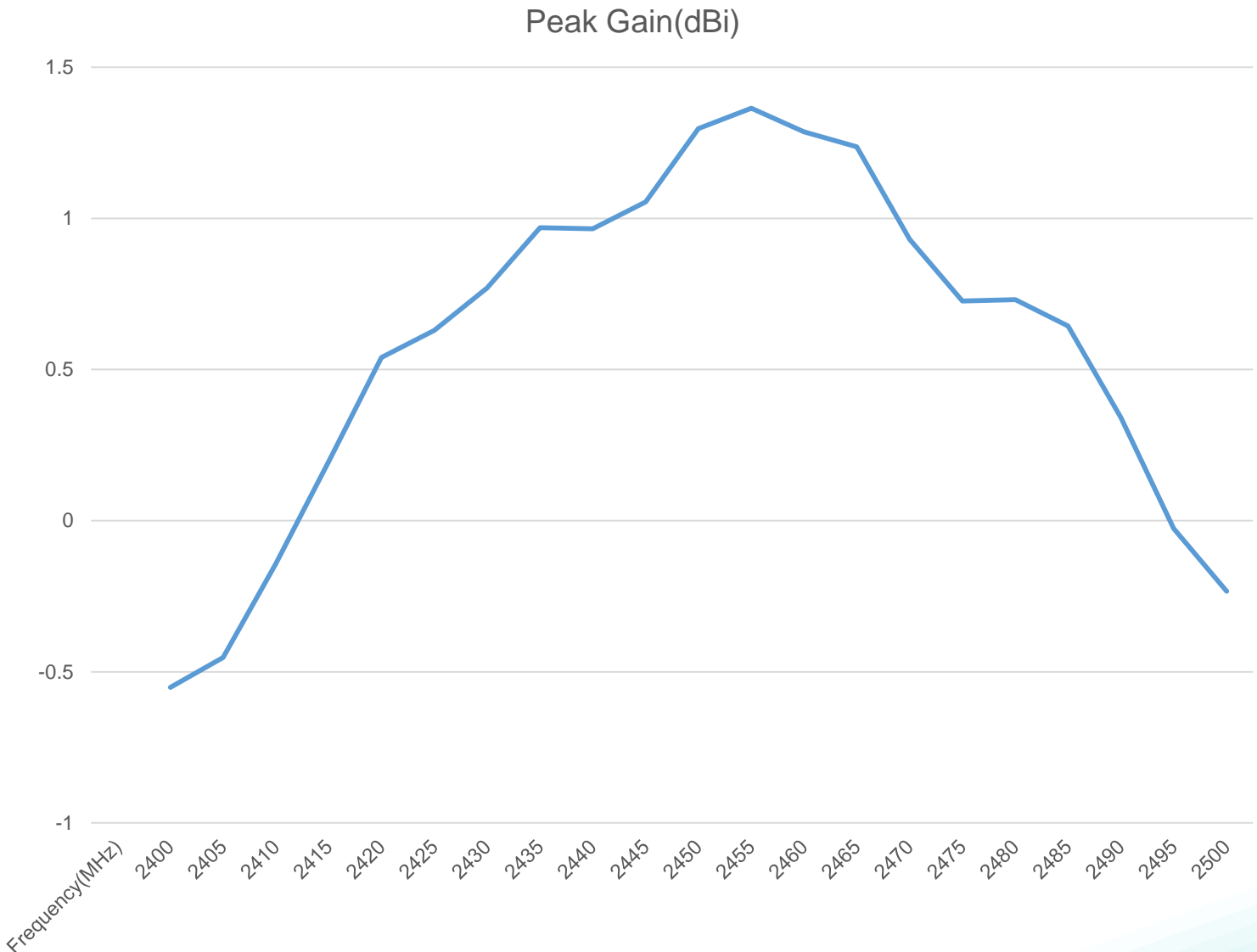

(*) All RF parameters measured on 80*37mm PCB with 4*6.25mm clearance in free space. No matching component used.

Issue: 1823

In the effort to improve our products, we reserve the right to make changes judged to be necessary.

CONFIDENTIAL AND PROPRIETARY INFORMATION

This document contains confidential and proprietary information of Pulse Electronics, Inc. (Pulse) and is protected by copyright, trade secret and other state and federal laws. Its receipt or possession does not convey any rights to reproduce, disclose its contents, or to manufacture, use or sell anything it may describe. Reproduction, disclosure or use without specific written authorization of Pulse is strictly forbidden.

Description: 2.4-2.4835GHz Ceramic SMT antenna, 4x6.25mm keep out area

Series: Chip Antenna

PART NUMBER: W3008C

CHARTS

Free Space Radiation Pattern

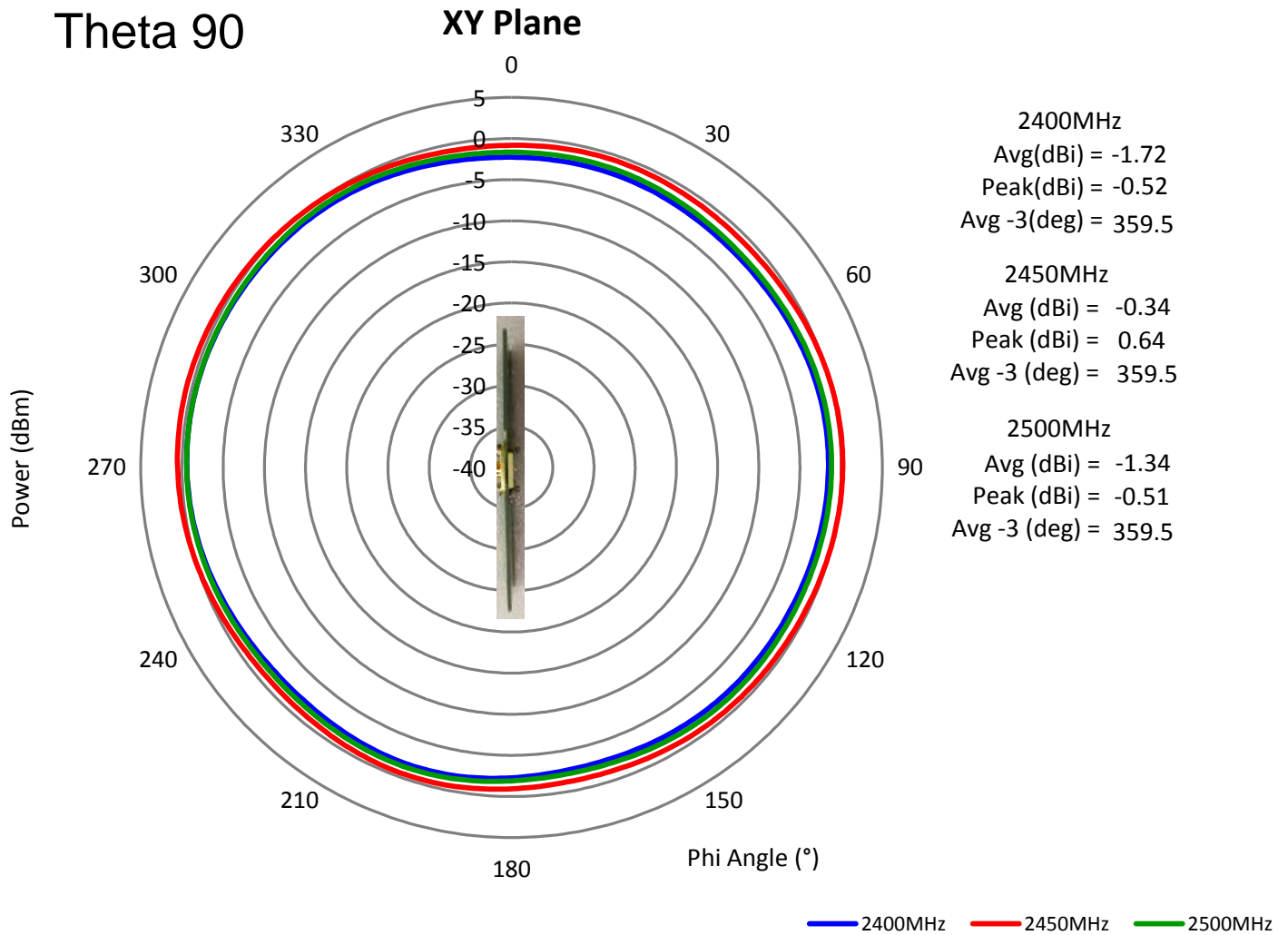

(* All RF parameters measured on 80*37mm PCB with 4*6.25mm clearance in free space. No matching component used.

Issue: 1823

In the effort to improve our products, we reserve the right to make changes judged to be necessary.

CONFIDENTIAL AND PROPRIETARY INFORMATION

This document contains confidential and proprietary information of Pulse Electronics, Inc. (Pulse) and is protected by copyright, trade secret and other state and federal laws. Its receipt or possession does not convey any rights to reproduce, disclose its contents, or to manufacture, use or sell anything it may describe. Reproduction, disclosure or use without specific written authorization of Pulse is strictly forbidden.

Description: 2.4-2.4835GHz Ceramic SMT antenna, 4x6.25mm keep out area

Series: Chip Antenna

PART NUMBER: W3008C

CHARTS

Free Space Radiation Pattern

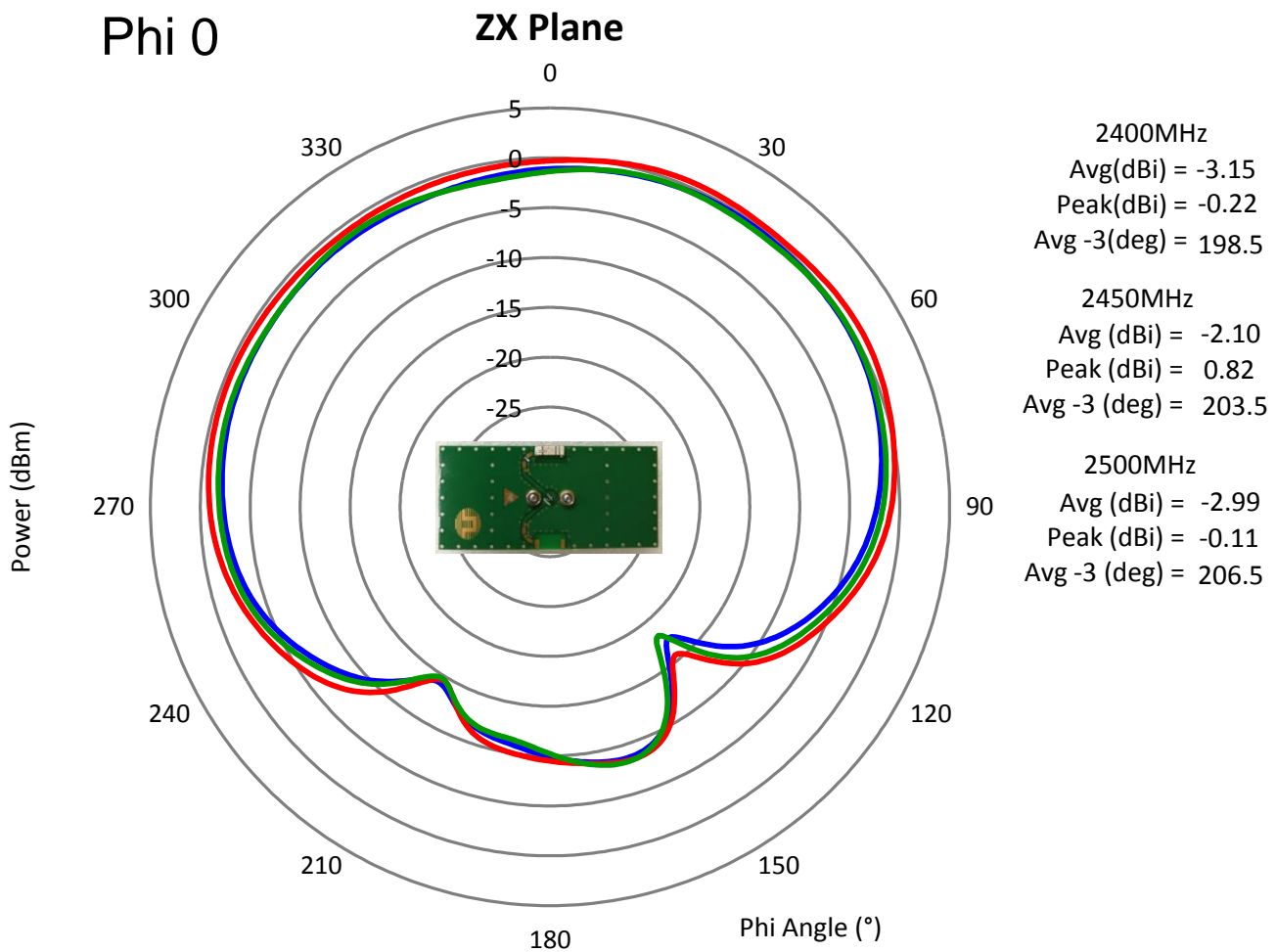

(* All RF parameters measured on 80*37mm PCB with 4*6.25mm clearance in free space. No matching component used.

Issue: 1823

In the effort to improve our products, we reserve the right to make changes judged to be necessary.

CONFIDENTIAL AND PROPRIETARY INFORMATION

This document contains confidential and proprietary information of Pulse Electronics, Inc. (Pulse) and is protected by copyright, trade secret and other state and federal laws. Its receipt or possession does not convey any rights to reproduce, disclose its contents, or to manufacture, use or sell anything it may describe. Reproduction, disclosure or use without specific written authorization of Pulse is strictly forbidden.

Description: 2.4-2.4835GHz Ceramic SMT antenna, 4x6.25mm keep out area

Series: Chip Antenna

PART NUMBER: W3008C

CHARTS

Free Space Radiation Pattern

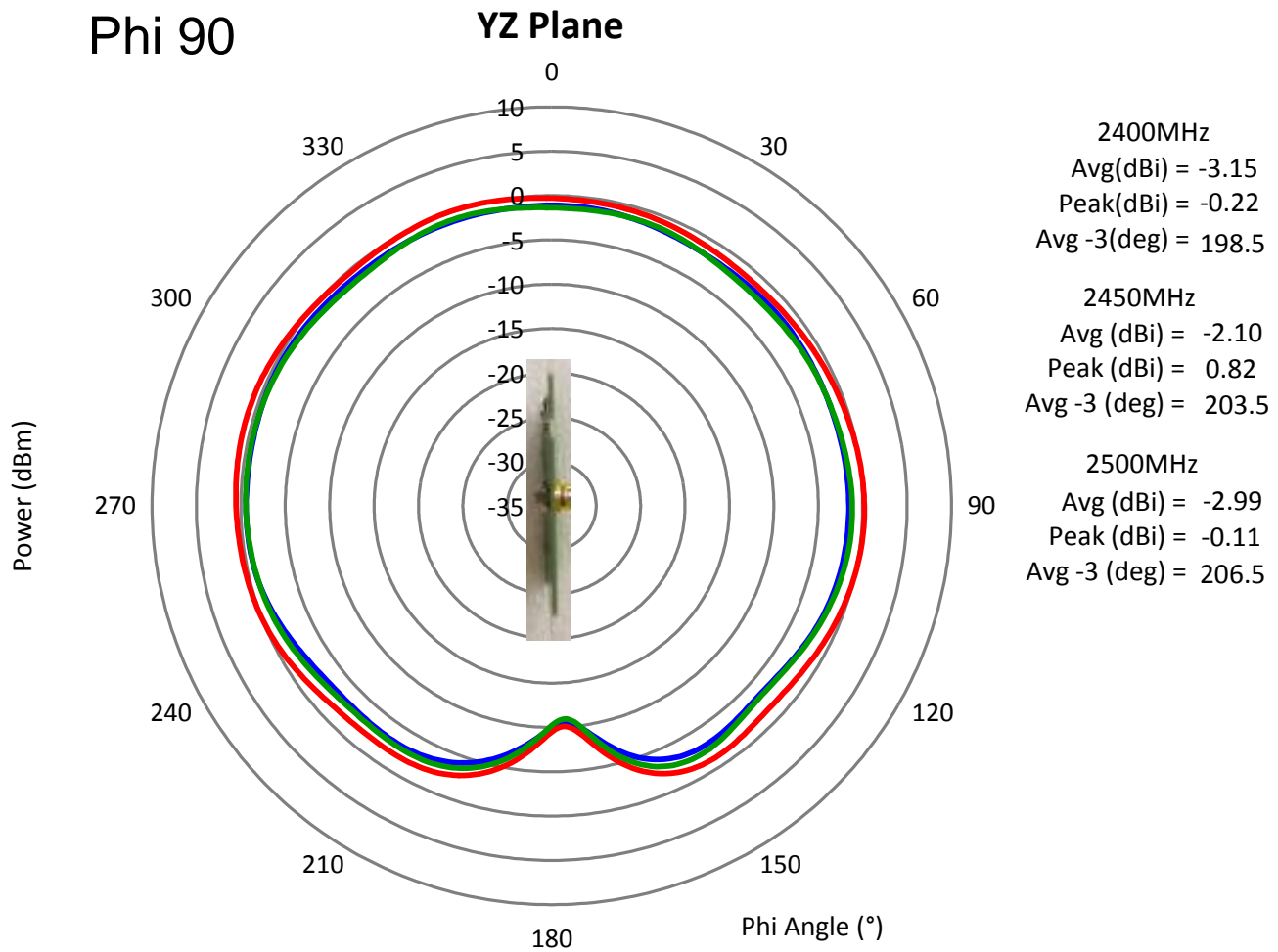

(* All RF parameters measured on 80*37mm PCB with 4*6.25mm clearance in free space. No matching component used.

Issue: 1823

In the effort to improve our products, we reserve the right to make changes judged to be necessary.

CONFIDENTIAL AND PROPRIETARY INFORMATION

This document contains confidential and proprietary information of Pulse Electronics, Inc. (Pulse) and is protected by copyright, trade secret and other state and federal laws. Its receipt or possession does not convey any rights to reproduce, disclose its contents, or to manufacture, use or sell anything it may describe. Reproduction, disclosure or use without specific written authorization of Pulse is strictly forbidden.

Description: 2.4-2.4835GHz Ceramic SMT antenna, 4x6.25mm keep out area

Series: Chip Antenna

PART NUMBER: W3008C

PACKAGING

3000pcs antennas per 7" reel

5pcs 7" reel per inner package box

2pcs inner box per out box

Total 30000pcs antenna per out box

Out box size: 390mmx215mmx165mm

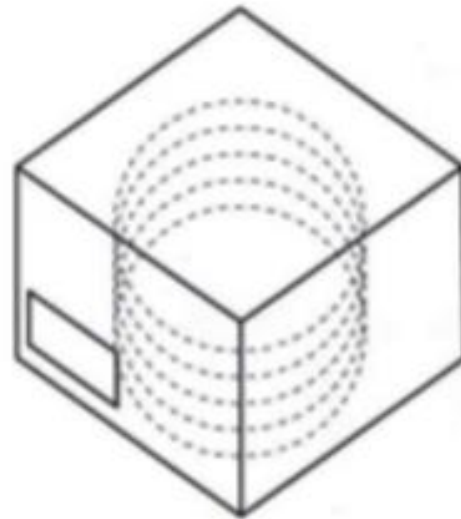
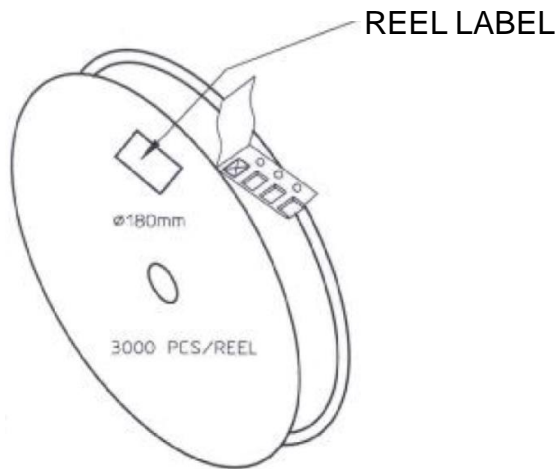

According to MSL3 packing requirement, MBB-Moisture Barrel Bag, Desiccant, HIC-Humidity Indicator Card, MSID Label, Caution Label are required.

单击下面可查看定价，库存，交付和生命周期等信息

[>>Pulse\(普思\)](#)