



PAN62311DM Black



PAN62312DM White

All dimensions are in mm / inches

Issue: 1833

In the effort to improve our products, we reserve the right to make changes judged to be necessary.

CONFIDENTIAL AND PROPRIETARY INFORMATION

This document contains confidential and proprietary information of Pulse Electronics, Inc. (Pulse) and is protected by copyright, trade secret and other state and federal laws. Its receipt or possession does not convey any rights to reproduce, disclose its contents, or to manufacture, use or sell anything it may describe. Reproduction, disclosure or use without specific written authorization of Pulse is strictly forbidden.

For more information:

Pulse Worldwide Headquarters
15255 Innovation Drive #100
San Diego, CA 92128
USA
Tel: 1-858-674-8100

Pulse/Larsen Antennas
18110 SE 34th St Bldg 2 Suite 250
Vancouver, WA 98683
USA
Tel: 1-360-944-75

Europe Headquarters
Pulse GmbH & Do, KG
Zeppelinstrasse 15
Herrenberg, Germany

Pulse (Suzhou) Wireless Products Co, Inc.
99 Huo Ju Road (#29 Bldg, 4th Phase
Suzhou New District
Jiangsu Province, Suzhou 215009 PR China
Tel: 86 512 6807 9998

Features:

- Supports 2xMIMO Cellular LTE 698-960/1695-2170/2300-2700/2900-3600MHz
- Supports 3xMIMO WiFi and DSRC 2400-2500MHz/4900-5925MHz
- Supports Beidou, GPS, Galileo, GLONASS, Active Satellite Antenna
- Direct Mount and optional Magnetic Mount features
- See GPSMBMM for magnetic mount details

Applications:

- Telematics
- Location based services
- First Responders (Police, Ambulance, Fire)
- Government
- Energy (Utility Vehicles)
- Fleet Management
- Railroad



This document covers all product variants of the following product family

Model NO.	PAN62311DM	PAN62312DM	PAN62311DMR	PAN62312DMR
Color	Black	White	Black	White
Cable NO.	6	6	6	6
Operating Bands	2-LTE+ 3WiFi+ 1-GPS/GNSS	2-LTE+ 3WiFi+ 1-GPS/GNSS	2-LTE+ 3WiFi+ 1-GPS/GNSS	2-LTE+ 3WiFi+ 1-GPS/GNSS
LET/WiFi Cable Type	RG58(Black)	RG58(White)	RG58HT(Black)	RG58HT(White)
GPS Cable Type	RG174(Black)	RG174(White)	RG174HT(Black)	RG174HT(White)
Cable length	17FT	17FT	17FT	17FT
Connector	LTE: SMA(M) WiFi: RP-SMA(M) GPS: SMA(M)	LTE: SMA(M) WiFi: RP-SMA(M) GPS: SMA(M)	LTE: SMA(M) WiFi: RP-SMA(M) GPS: SMA(M)	LTE: SMA(M) WiFi: RP-SMA(M) GPS: SMA(M)
Assembly option	1.Assembly directly with nut 2.Magnetic mount base P/N:GPSMBMM			
Remark			Compliant with EN 50155, EN 61373, EN45545-2, Railroad application.	Compliant with EN 50155, EN 61373, EN45545-2, Railroad application.

Issue: 1833

In the effort to improve our products, we reserve the right to make changes judged to be necessary.

CONFIDENTIAL AND PROPRIETARY INFORMATION

This document contains confidential and proprietary information of Pulse Electronics, Inc. (Pulse) and is protected by copyright, trade secret and other state and federal laws. Its receipt or possession does not convey any rights to reproduce, disclose its contents, or to manufacture, use or sell anything it may describe. Reproduction, disclosure or use without specific written authorization of Pulse is strictly forbidden.

For more information:

Pulse Worldwide Headquarters
15255 Innovation Drive #100
San Diego, CA 92128
USA
Tel: 1-858-674-8100

Pulse/Larsen Antennas
18110 SE 34th St Bldg 2 Suite 250
Vancouver, WA 98683
USA
Tel: 1-360-944-75

Europe Headquarters
Pulse GmbH & Do, KG
Zeppelinstrasse 15
Herrenberg, Germany

Pulse (Suzhou) Wireless Products Co, Inc.
99 Huo Ju Road(#29 Bldg,4th Phase
Suzhou New District
Jiangsu Province, Suzhou 215009 PR China
Tel: 86 512 6807 9998

Description: 2xMiMo LTE, 3xMiMo WiFi,
GNSS Vehicle Mount Antenna

Series: Panther

PART NUMBER: PAN62311DM, PAN62312DM,
PAN62311DMR, PAN62312DMR

Frequency (2XLTE)	698 - 960 / 1695 – 2170 / 2300 - 2700 / 2900 – 3600	MHz
Frequency (3XWiFi&DSRC)	2400 – 2500/ 4900 – 5925	MHz
Frequency (1XGNSS)	1561.098±2.046/ 1575.42±1.023/ 1602.5625±4	MHz
Nominal Impedance	50	Ω
VSWR** (LTE)	< 1.5	
VSWR** (WiFi&DSRC)	< 1.4	
Gain* (LTE antenna, < 2170 MHz)	4	dBi ± 2.5 dB
Gain* (LTE antenna, > 2170 MHz)	5	dBi ± 2 dB
Gain* (WiFi antenna, < 2500 MHz)	4.5	dBi ± 1.5 dB
Gain* (WiFi antenna, > 4900 MHz)	5	dBi ± 2 dB
Isolation LTE to LTE **	15 or better	dB
Isolation WiFi to WiFi **	25 or better	dB
GNSS antenna RHCP gain	1	dBic ± 2 dB
LNA gain	30	dB ± 2 dB
Noise Figure	2.5 (cascade)	dB
Current	9	mA ± 2 mA
V _{dc}	3-5	V _{dc}
LNA and filter attenuation		
	@ 824 MHz	70 dB
	@ 960 MHz	65 dB
	@ 1710 MHz	60 dB
	@ 2170 MHz	65 dB

*Measured on 2ft GND plane and with 4 inch cables

**In free space with 17ft cables

Issue: 1833

In the effort to improve our products, we reserve the right to make changes judged to be necessary.

CONFIDENTIAL AND PROPRIETARY INFORMATION

This document contains confidential and proprietary information of Pulse Electronics, Inc. (Pulse) and is protected by copyright, trade secret and other state and federal laws. Its receipt or possession does not convey any rights to reproduce, disclose its contents, or to manufacture, use or sell anything it may describe. Reproduction, disclosure or use without specific written authorization of Pulse is strictly forbidden.

MECHANICAL SPECIFICATIONS

Plastic radome for PAN62311DM/PAN62312DM	ABS/PC Material UV Stabilized, UL-94HB
for PAN62311DMR/PAN62312DMR	PC material, EN45545 R6 HL3 compliant
Color	Black, White
Ingress Protection	IP67
Weight	~1540 g
Fixing system	Roof mounting (Also Magnet mounting accessory available, GPSMBMM) Recommended fastening torque 1518ft-lb (20-25Nm).

ENVIRONMENTAL SPECIFICATIONS

Operating temperature	MIL-STD 810G -40/+85° C
Humidity	95%RH @ +25°C for 12h and 55°C for 12h
Vibration	MIL-STD 810G, section 514.6 , 5-500 Hz, 60min/axis
Thermal Shocks	MIL-STD 810G, section 503.5, -40 to +85°C, 3 cycles
Drop Test	Minimum of one drop per axis – 4, 1 meter drops

Tests for railroad certification per EN50155, EN61373, EN45545-2

NO	T SN IN STAND	TEST DESCRIPTION	REFER STANDARD	TEST REPORT NO	RESULT(PASS/FAIL)
1	12.2.3	Cooling test	EN 50155	DD20170919002	PASS
2	12.2.4	Dry heat test			
3	12.2.5	Damp heat test, cyclic			
4	12.2.6	Supply overvoltages	EN 50155	W01714200900E	PASS
5	12.2.7	Surges, electrostatic discharge and transient burst susceptibility tests	EN 50155	E1710056-01E	PASS
6	12.2.8	Radio interference			
7	12.2.9	Insulation test	EN 50155	E17110014-01E	PASS
8	12.2.10	Salt mist test	EN 50155	DD20170919002	PASS
9	12.2.11	Vibration	EN 61373		
		Shock, and bump test	EN 61373		
10	12.2.12	Watertightness test	EN 50155		
11	12.2.14	Low temperature storage test	EN 50155	TC 18 02 000528	HL1&HL2
12	/	fire & smoke	EN 45545-2 R15&R16		
			EN 45545-2 R15&R16	TC.18.04.001633	HL1&HL2&HL3

MECHANICAL DRAWING

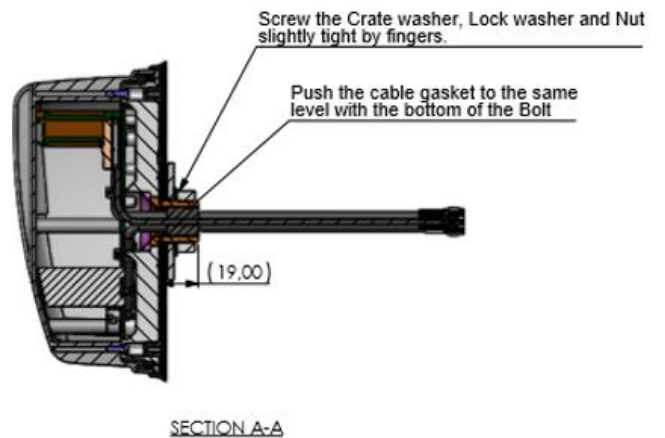
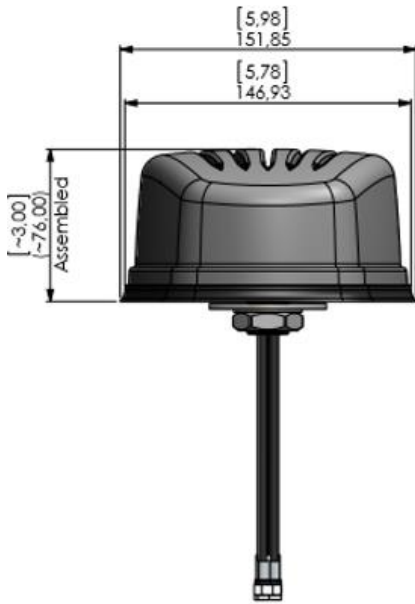

Series: Panther

TECHNICAL DATA SHEET

Description: 2xMiMo LTE, 3xMiMo WiFi,
GNSS Vehicle Mount Antenna

PART NUMBER: PAN62311DM, PAN62312DM,
PAN62311DMR, PAN62312DMR

TEST SETUP



For VSWR, test in free space with 17ft cables

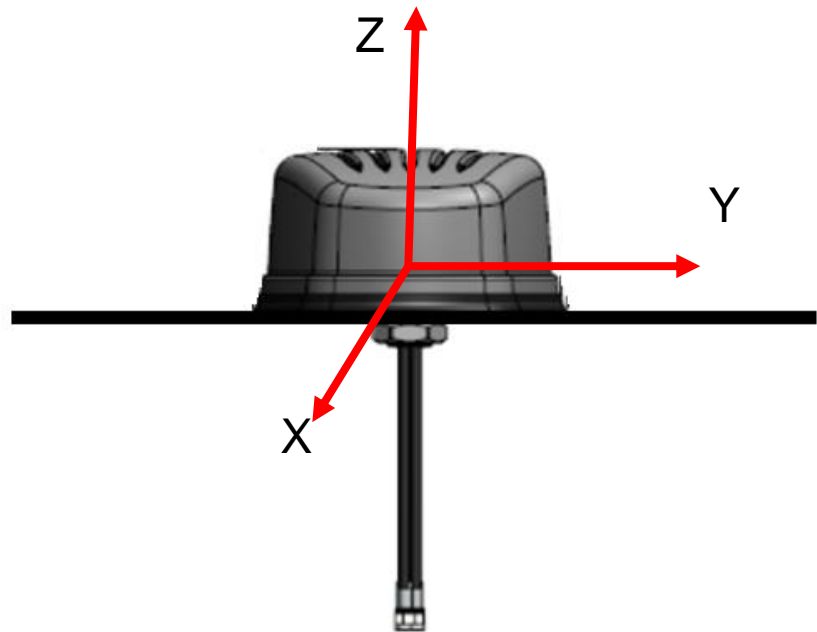

For radiation performance, test on 2ft GND plane with 4inch cables

CHARTS

VSWR of LTE antenna

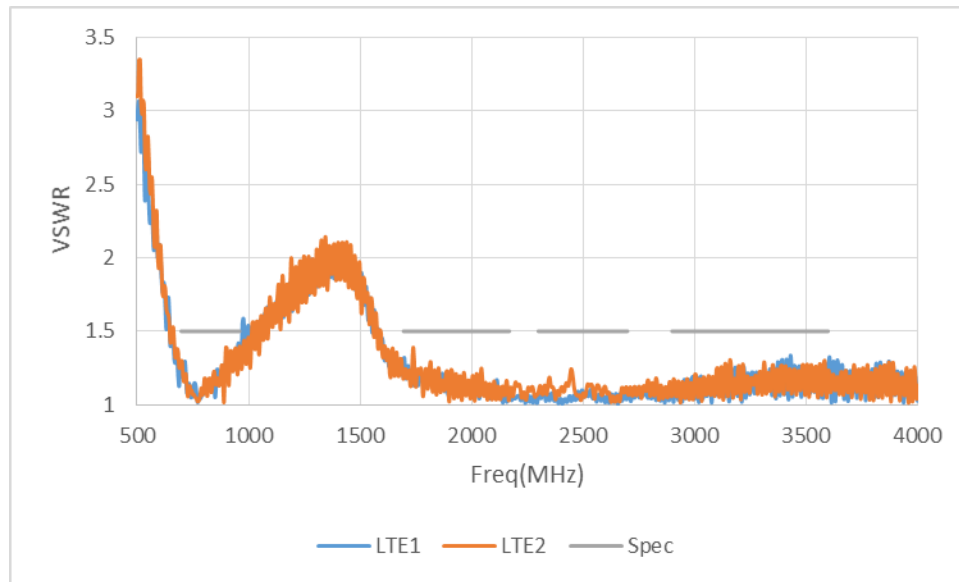

VSWR of WiFi antenna

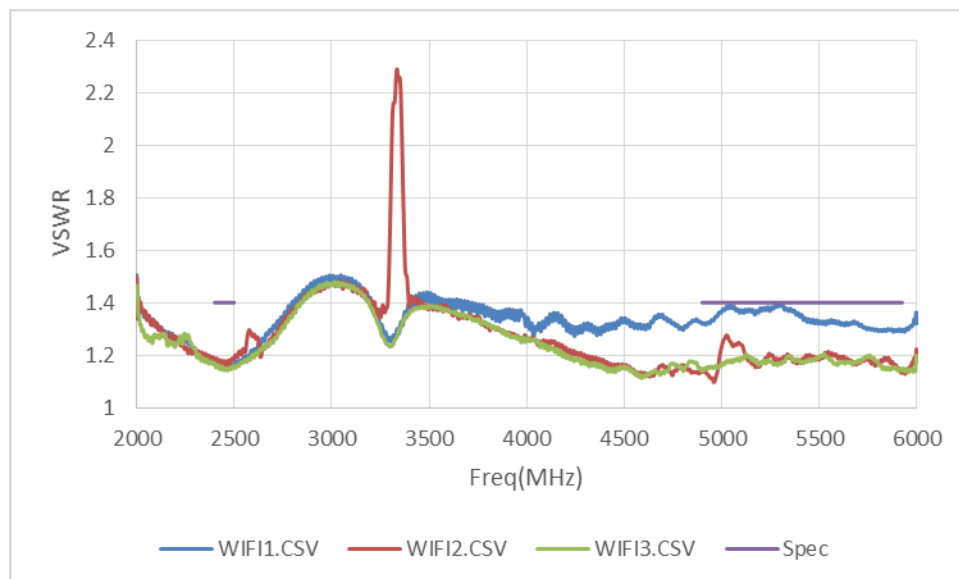

Issue: 1833

In the effort to improve our products, we reserve the right to make changes judged to be necessary.

CONFIDENTIAL AND PROPRIETARY INFORMATION

This document contains confidential and proprietary information of Pulse Electronics, Inc. (Pulse) and is protected by copyright, trade secret and other state and federal laws. Its receipt or possession does not convey any rights to reproduce, disclose its contents, or to manufacture, use or sell anything it may describe. Reproduction, disclosure or use without specific written authorization of Pulse is strictly forbidden.

CHARTS

Isolation of LTE antenna

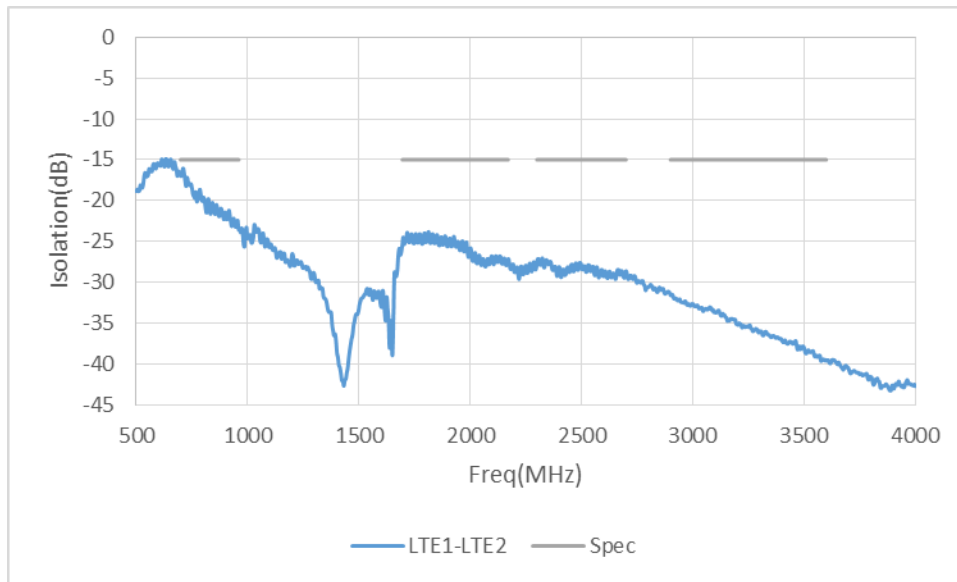

Isolation of WiFi antenna

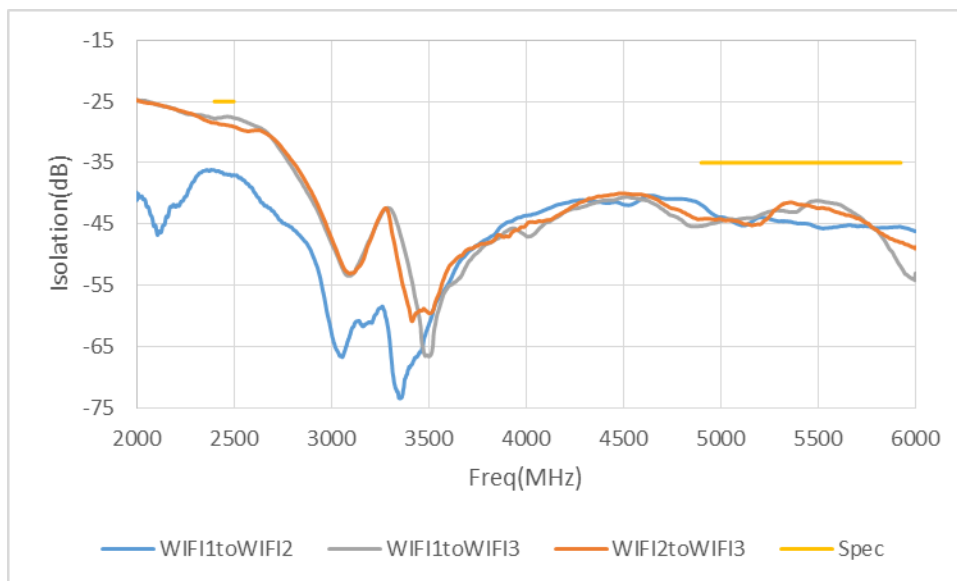

Issue: 1833

In the effort to improve our products, we reserve the right to make changes judged to be necessary.

CONFIDENTIAL AND PROPRIETARY INFORMATION

This document contains confidential and proprietary information of Pulse Electronics, Inc. (Pulse) and is protected by copyright, trade secret and other state and federal laws. Its receipt or possession does not convey any rights to reproduce, disclose its contents, or to manufacture, use or sell anything it may describe. Reproduction, disclosure or use without specific written authorization of Pulse is strictly forbidden.

CHARTS

Isolation of LTE1 antenna to WiFi antenna

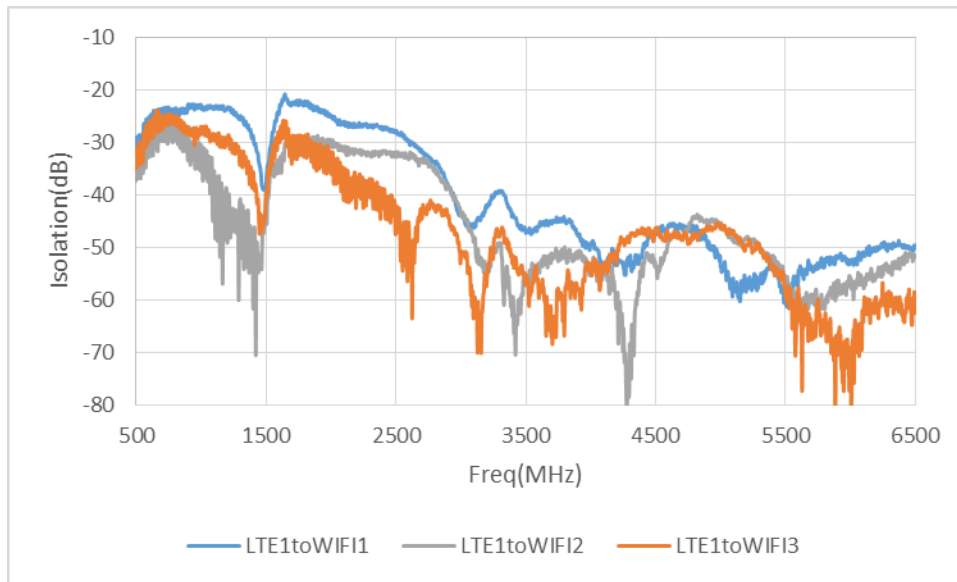

Isolation of LTE2 antenna to WiFi antenna

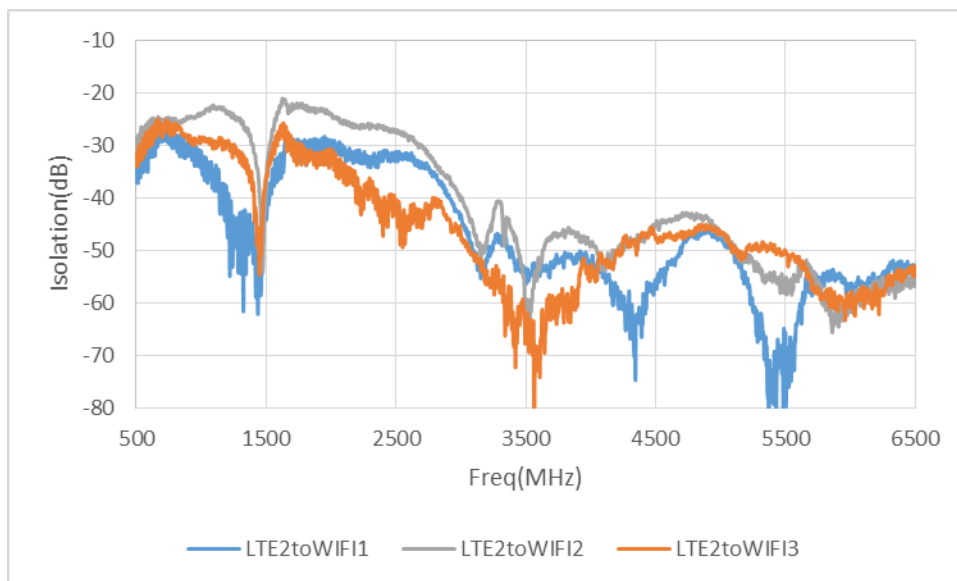

Issue: 1833

In the effort to improve our products, we reserve the right to make changes judged to be necessary.

CONFIDENTIAL AND PROPRIETARY INFORMATION

This document contains confidential and proprietary information of Pulse Electronics, Inc. (Pulse) and is protected by copyright, trade secret and other state and federal laws. Its receipt or possession does not convey any rights to reproduce, disclose its contents, or to manufacture, use or sell anything it may describe. Reproduction, disclosure or use without specific written authorization of Pulse is strictly forbidden.

CHARTS

Isolation of GNSS antenna to LTE antenna



Isolation of GNSS antenna to WiFi antenna

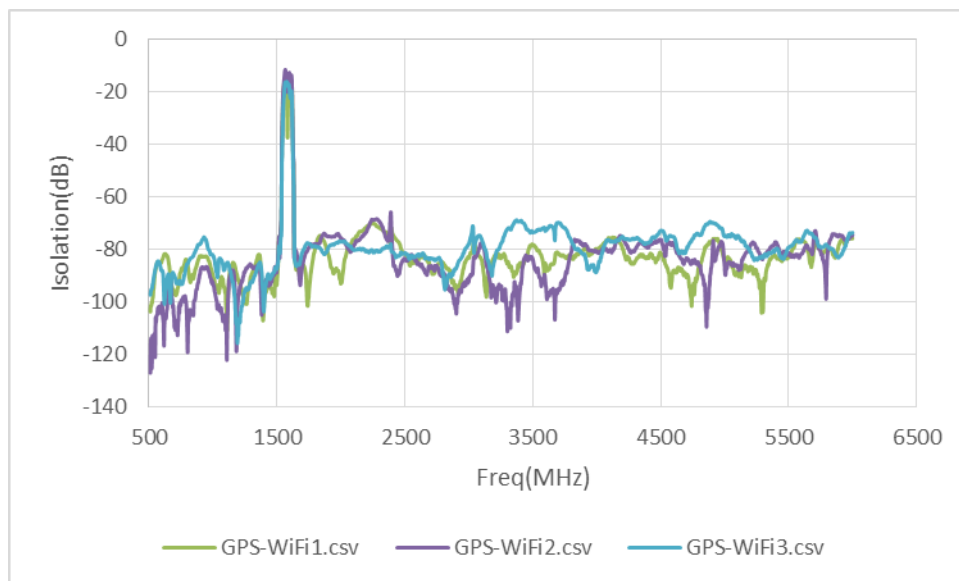

Issue: 1833

In the effort to improve our products, we reserve the right to make changes judged to be necessary.

CONFIDENTIAL AND PROPRIETARY INFORMATION

This document contains confidential and proprietary information of Pulse Electronics, Inc. (Pulse) and is protected by copyright, trade secret and other state and federal laws. Its receipt or possession does not convey any rights to reproduce, disclose its contents, or to manufacture, use or sell anything it may describe. Reproduction, disclosure or use without specific written authorization of Pulse is strictly forbidden.

CHARTS

GNSS LNA performance

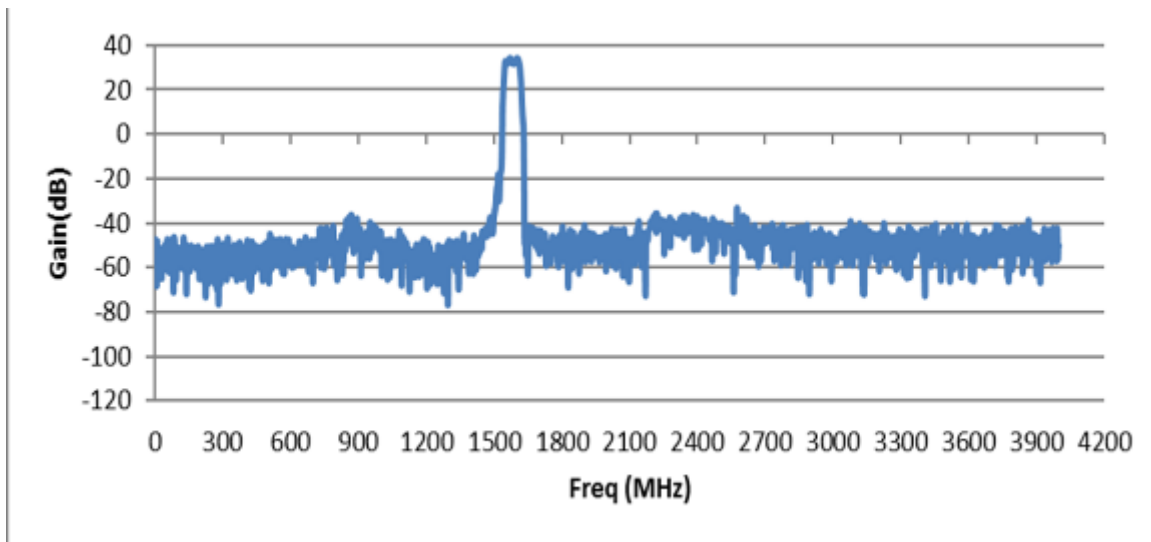

CHARTS

LTE antenna total efficiency on ground plane**

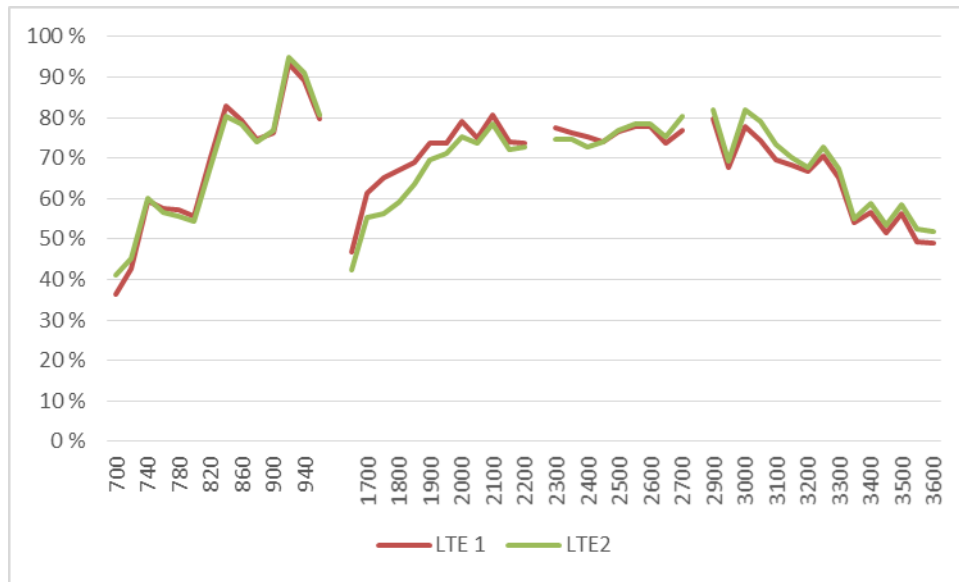

Maximum 3D gain, LTE antenna on ground plane**

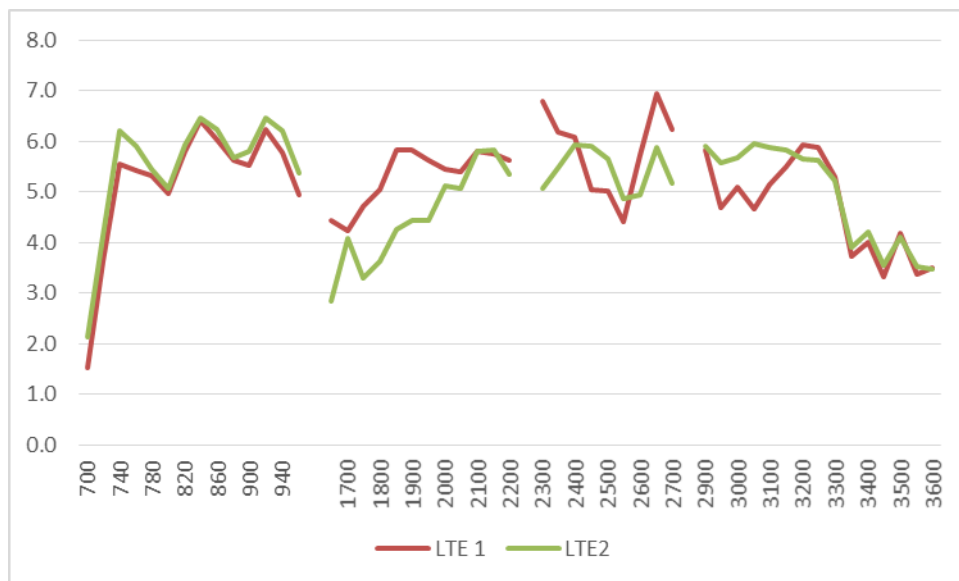

Issue: 1833

In the effort to improve our products, we reserve the right to make changes judged to be necessary.

CONFIDENTIAL AND PROPRIETARY INFORMATION

This document contains confidential and proprietary information of Pulse Electronics, Inc. (Pulse) and is protected by copyright, trade secret and other state and federal laws. Its receipt or possession does not convey any rights to reproduce, disclose its contents, or to manufacture, use or sell anything it may describe. Reproduction, disclosure or use without specific written authorization of Pulse is strictly forbidden.

CHARTS

WiFi antenna total efficiency on ground plane**

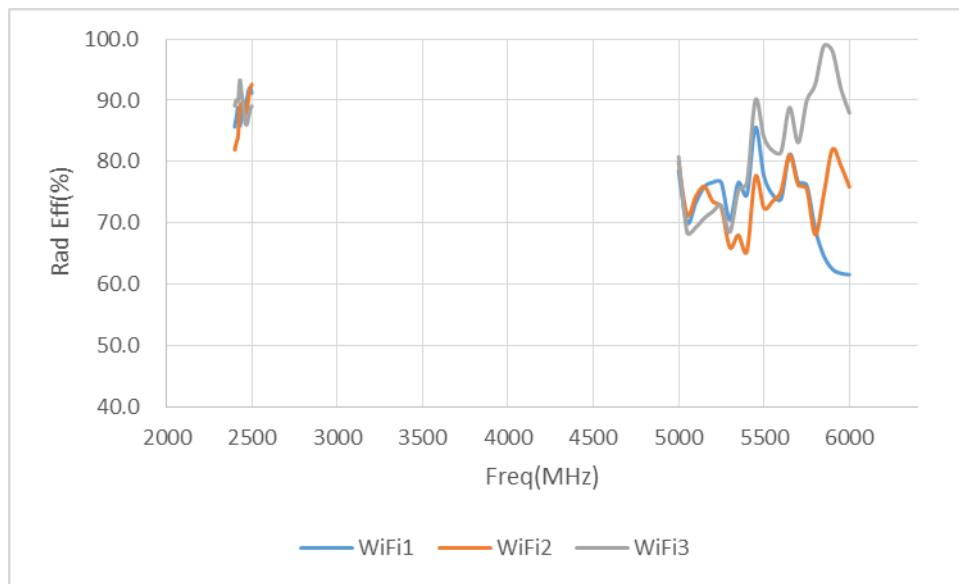

Maximum 3D gain, WiFi antenna on ground plane**

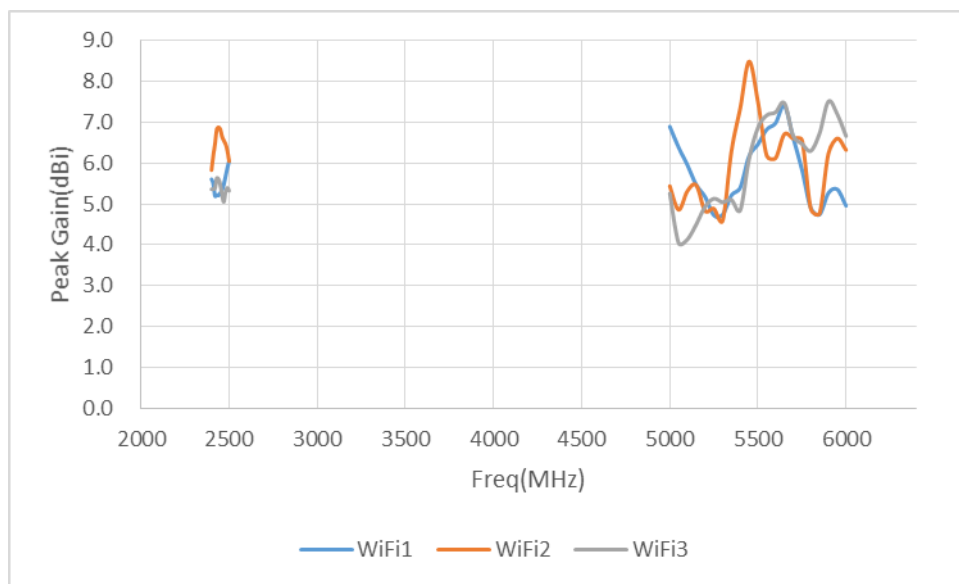

CHARTS

LTE1 antenna X-Y plane radiation pattern at LTE low band**

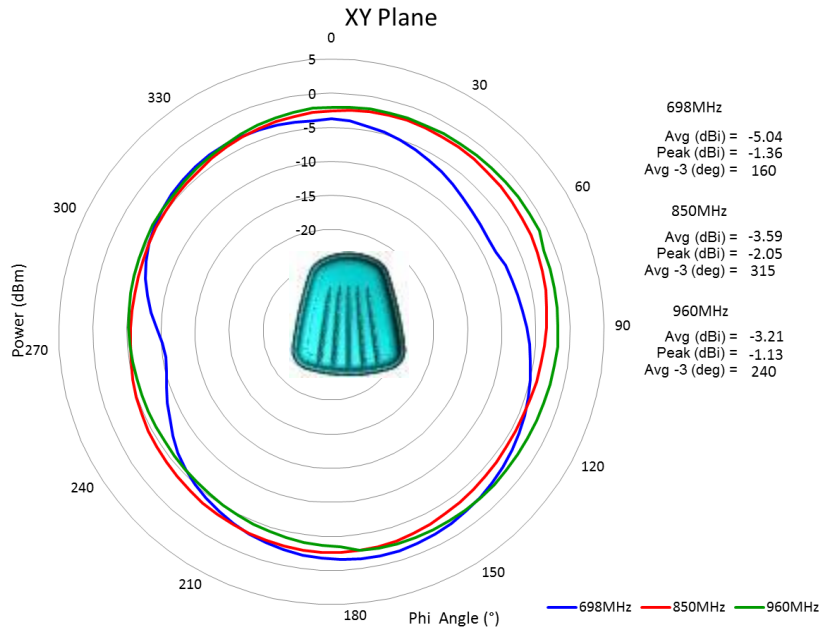

LTE1 antenna Z-X plane radiation pattern at LTE low band**

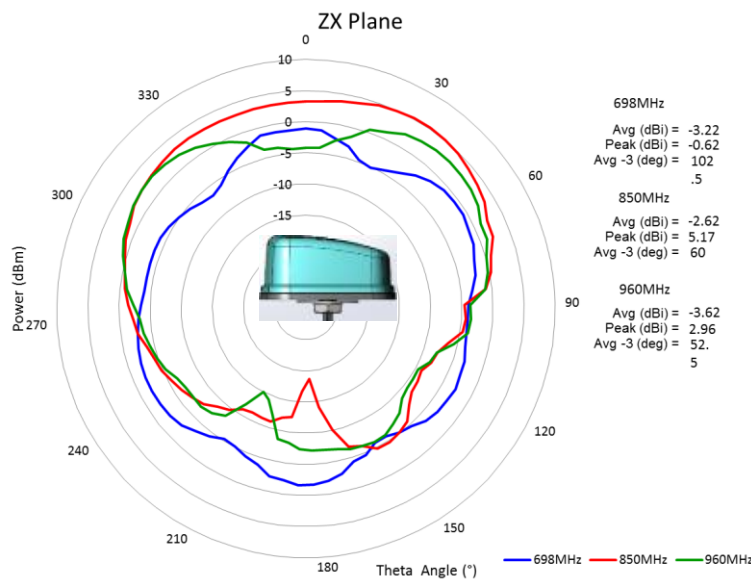

Issue: 1833

In the effort to improve our products, we reserve the right to make changes judged to be necessary.

CONFIDENTIAL AND PROPRIETARY INFORMATION

This document contains confidential and proprietary information of Pulse Electronics, Inc. (Pulse) and is protected by copyright, trade secret and other state and federal laws. Its receipt or possession does not convey any rights to reproduce, disclose its contents, or to manufacture, use or sell anything it may describe. Reproduction, disclosure or use without specific written authorization of Pulse is strictly forbidden.

CHARTS

LTE1 antenna Y-Z plane radiation pattern at LTE low band**

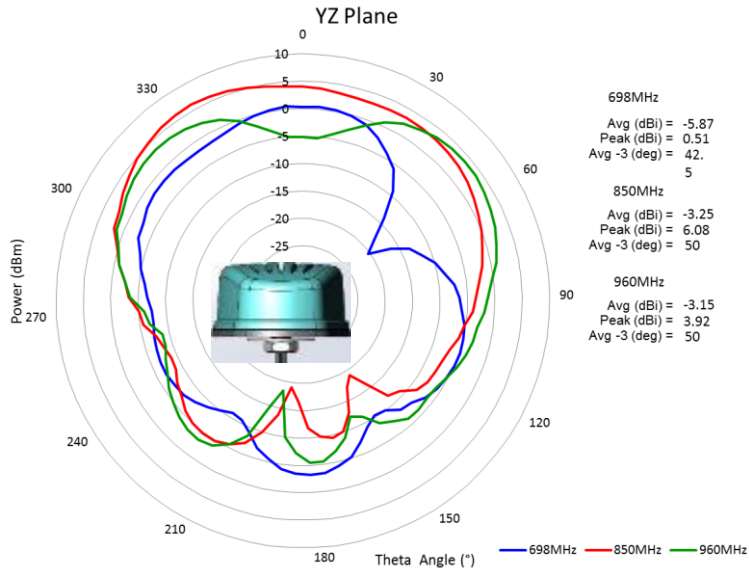

CHARTS

LTE1 antenna X-Y plane radiation pattern at LTE high band**

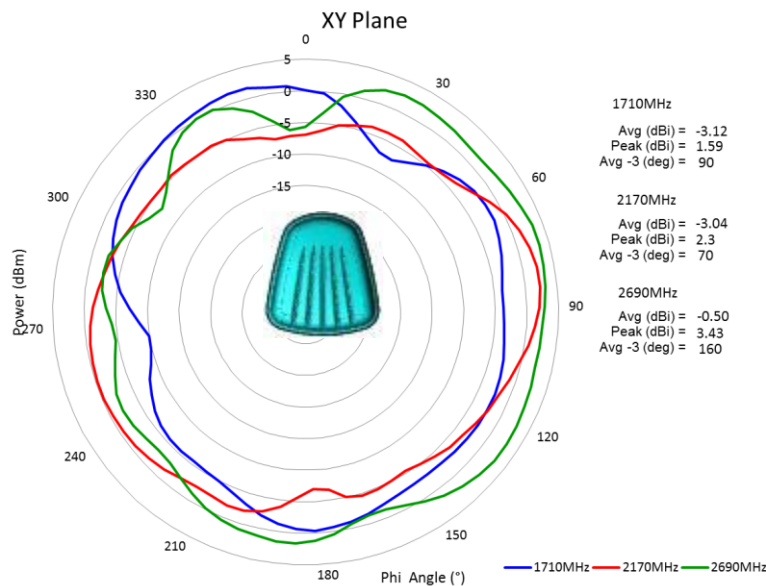

LTE1 antenna Z-X plane radiation pattern at LTE high band**

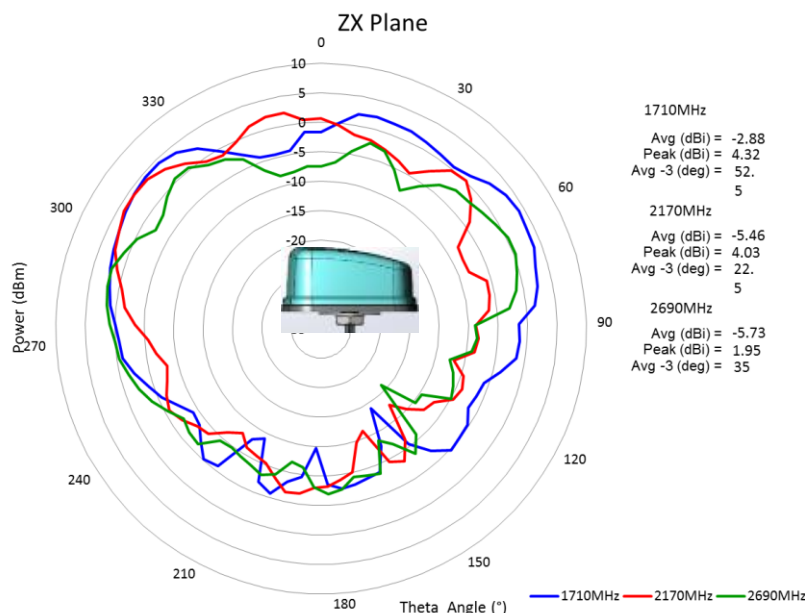

Issue: 1833

In the effort to improve our products, we reserve the right to make changes judged to be necessary.

CONFIDENTIAL AND PROPRIETARY INFORMATION

This document contains confidential and proprietary information of Pulse Electronics, Inc. (Pulse) and is protected by copyright, trade secret and other state and federal laws. Its receipt or possession does not convey any rights to reproduce, disclose its contents, or to manufacture, use or sell anything it may describe. Reproduction, disclosure or use without specific written authorization of Pulse is strictly forbidden.

CHARTS

LTE1 antenna Y-Z plane radiation pattern at LTE high band**

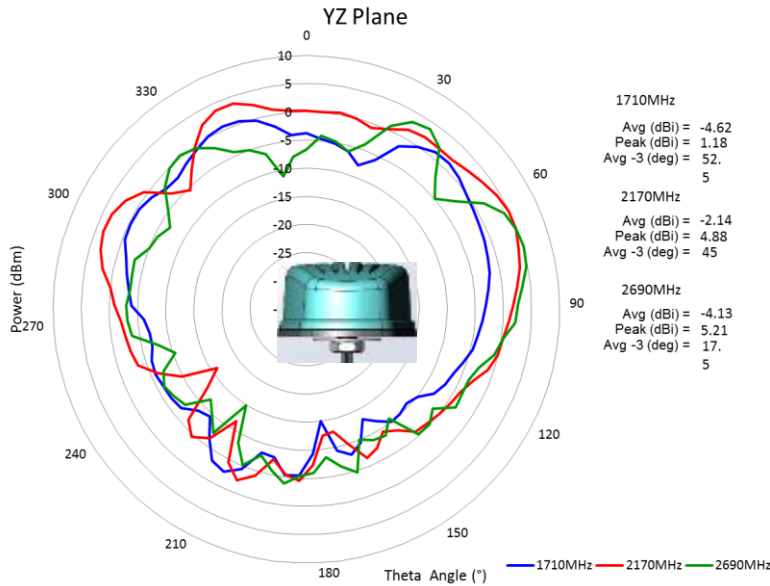

CHARTS

LTE2 antenna X-Y plane radiation pattern at LTE low band**

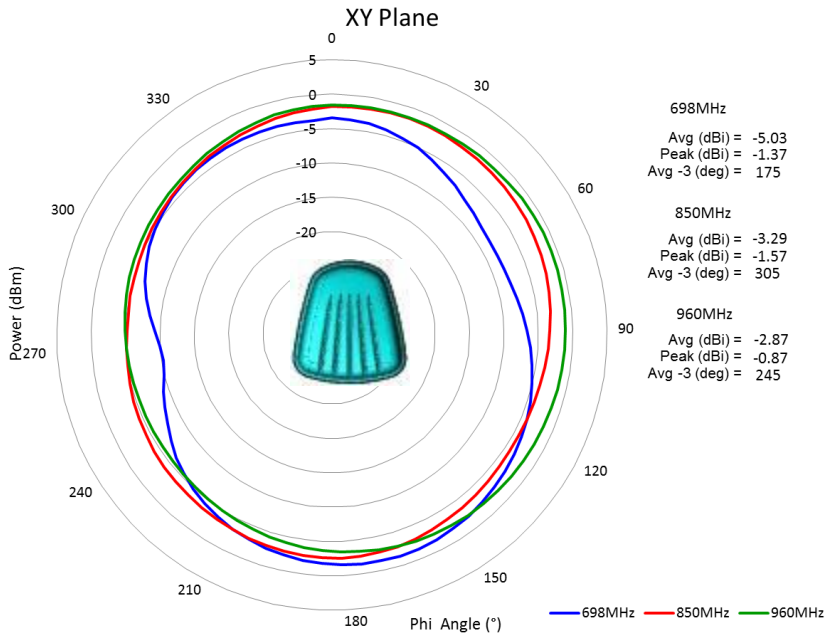

LTE2 antenna Z-X plane radiation pattern at LTE low band**

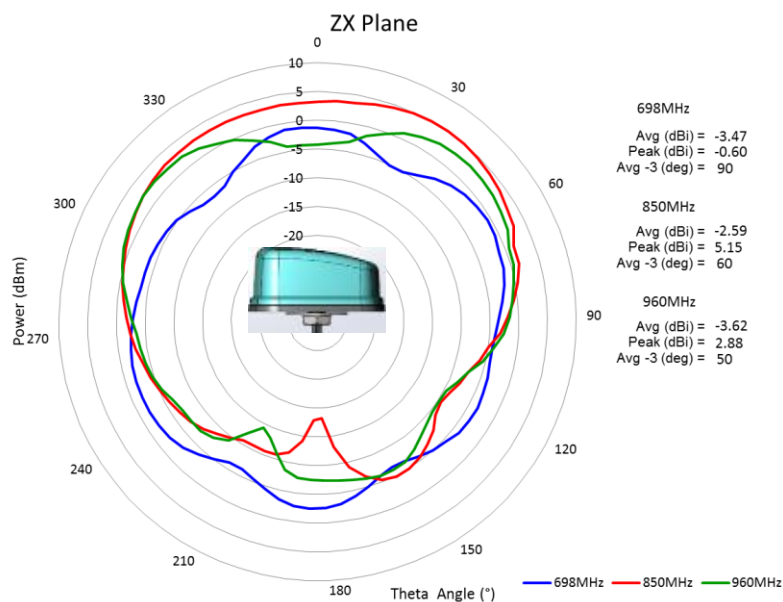

Issue: 1833

In the effort to improve our products, we reserve the right to make changes judged to be necessary.

CONFIDENTIAL AND PROPRIETARY INFORMATION

This document contains confidential and proprietary information of Pulse Electronics, Inc. (Pulse) and is protected by copyright, trade secret and other state and federal laws. Its receipt or possession does not convey any rights to reproduce, disclose its contents, or to manufacture, use or sell anything it may describe. Reproduction, disclosure or use without specific written authorization of Pulse is strictly forbidden.

CHARTS

LTE2 antenna Y-Z plane radiation pattern at LTE low band**

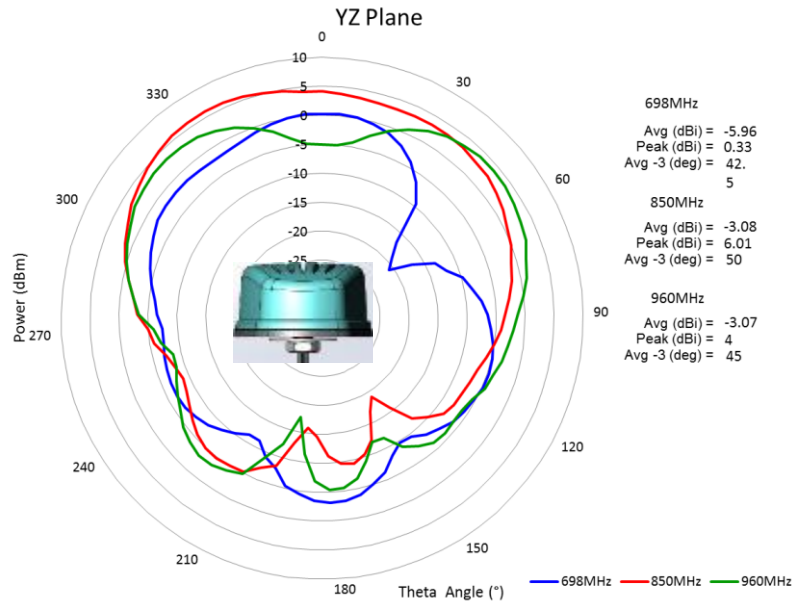

CHARTS

LTE2 antenna X-Y plane radiation pattern at LTE high band**

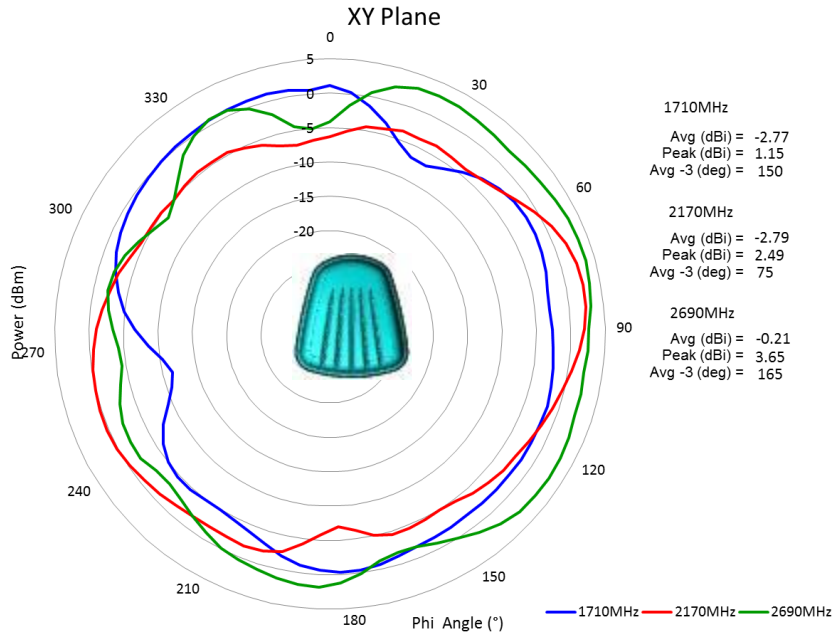

LTE2 antenna Z-X plane radiation pattern at LTE high band**

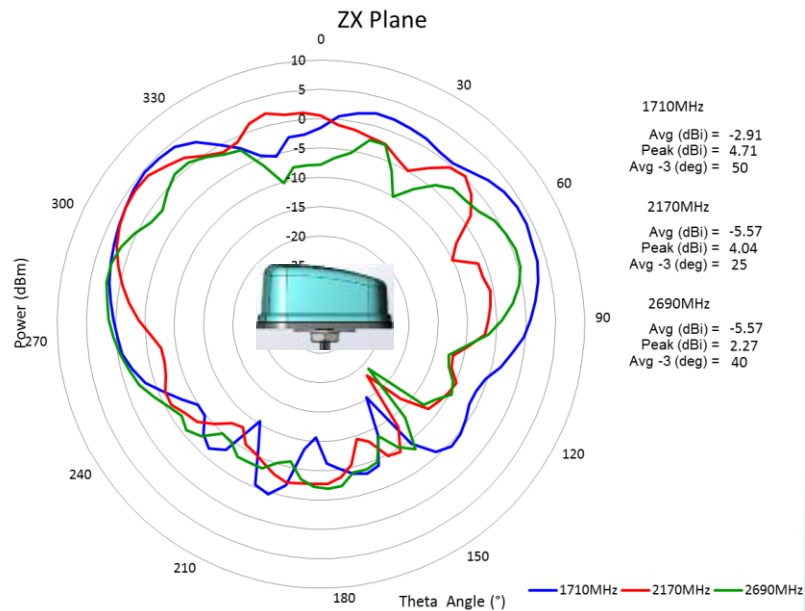

Issue: 1833

In the effort to improve our products, we reserve the right to make changes judged to be necessary.

CONFIDENTIAL AND PROPRIETARY INFORMATION

This document contains confidential and proprietary information of Pulse Electronics, Inc. (Pulse) and is protected by copyright, trade secret and other state and federal laws. Its receipt or possession does not convey any rights to reproduce, disclose its contents, or to manufacture, use or sell anything it may describe. Reproduction, disclosure or use without specific written authorization of Pulse is strictly forbidden.

CHARTS

LTE2 antenna Y-Z plane radiation pattern at LTE high band**

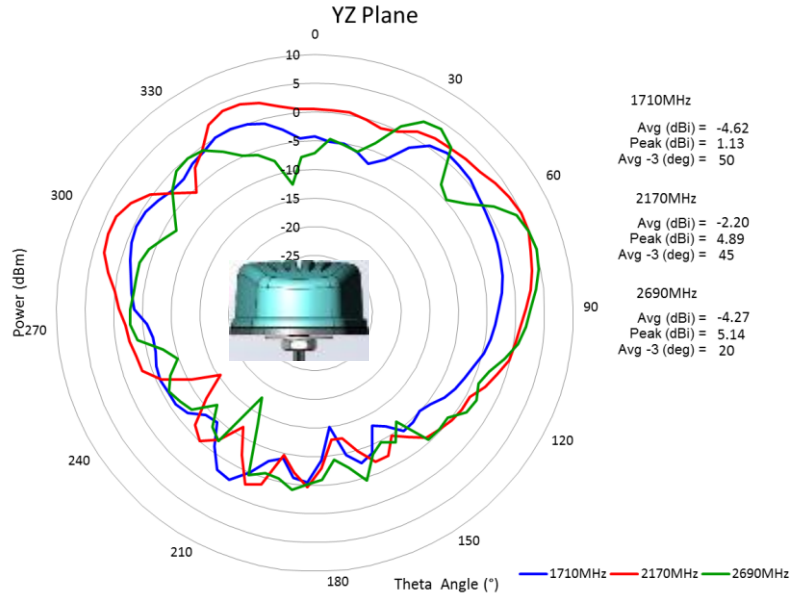

CHARTS

WiFi1 antenna X-Y plane radiation pattern at WiFi low band**

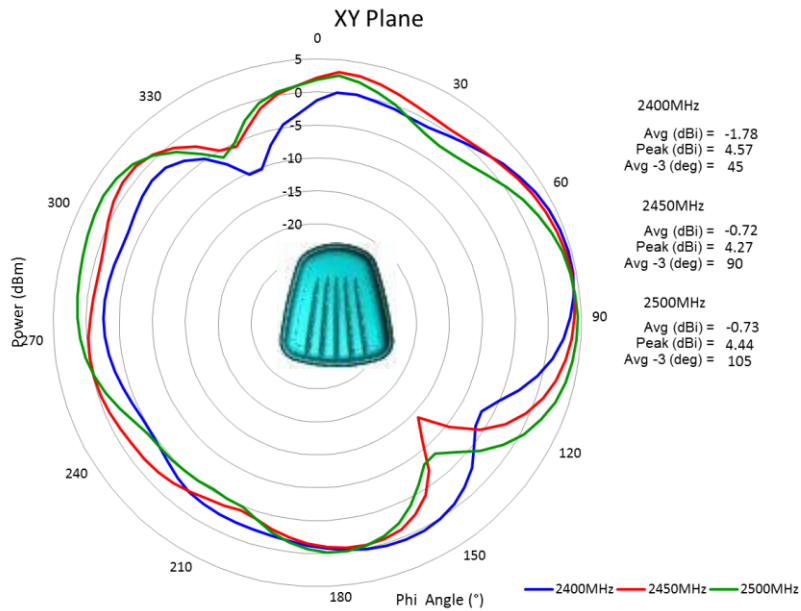

WiFi1 antenna Z-X plane radiation pattern at WiFi low band**

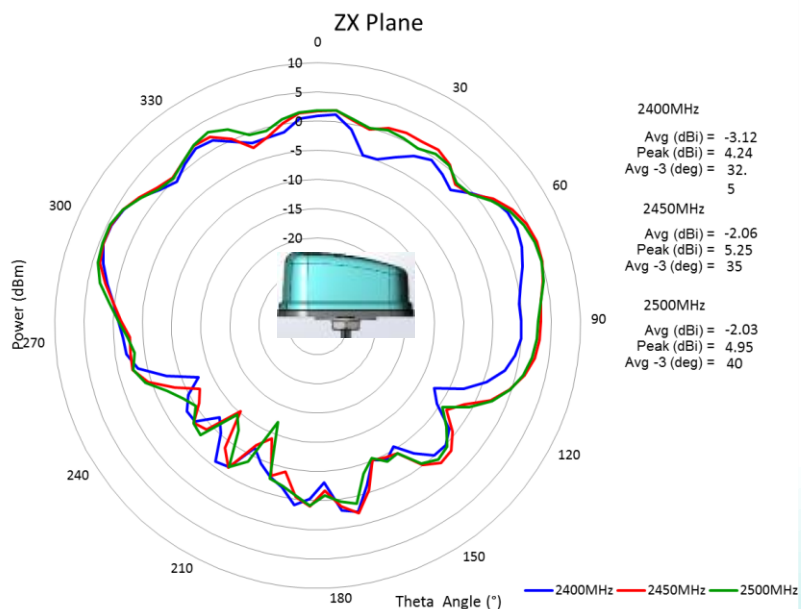

Issue: 1833

In the effort to improve our products, we reserve the right to make changes judged to be necessary.

CONFIDENTIAL AND PROPRIETARY INFORMATION

This document contains confidential and proprietary information of Pulse Electronics, Inc. (Pulse) and is protected by copyright, trade secret and other state and federal laws. Its receipt or possession does not convey any rights to reproduce, disclose its contents, or to manufacture, use or sell anything it may describe. Reproduction, disclosure or use without specific written authorization of Pulse is strictly forbidden.

CHARTS

WiFi1 antenna Y-Z plane radiation pattern at WiFi low band**

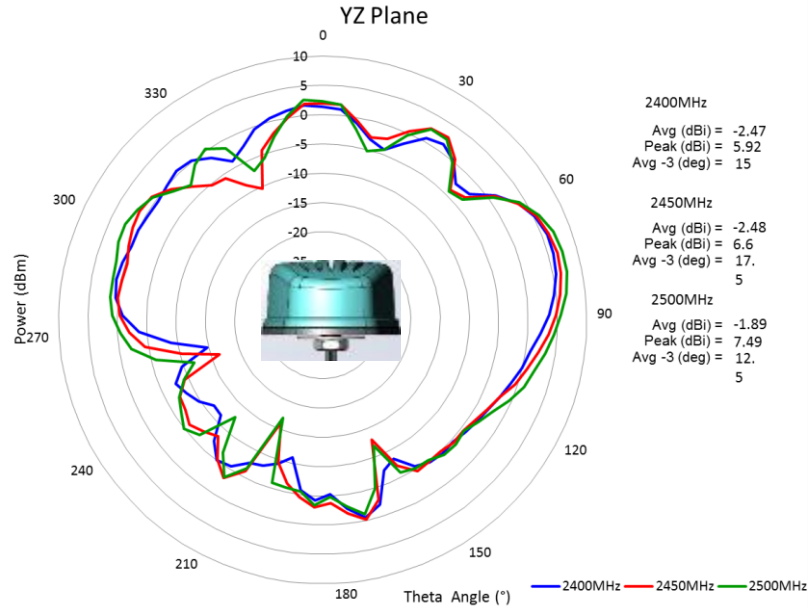

CHARTS

WiFi1 antenna X-Y plane radiation pattern at WiFi high band**

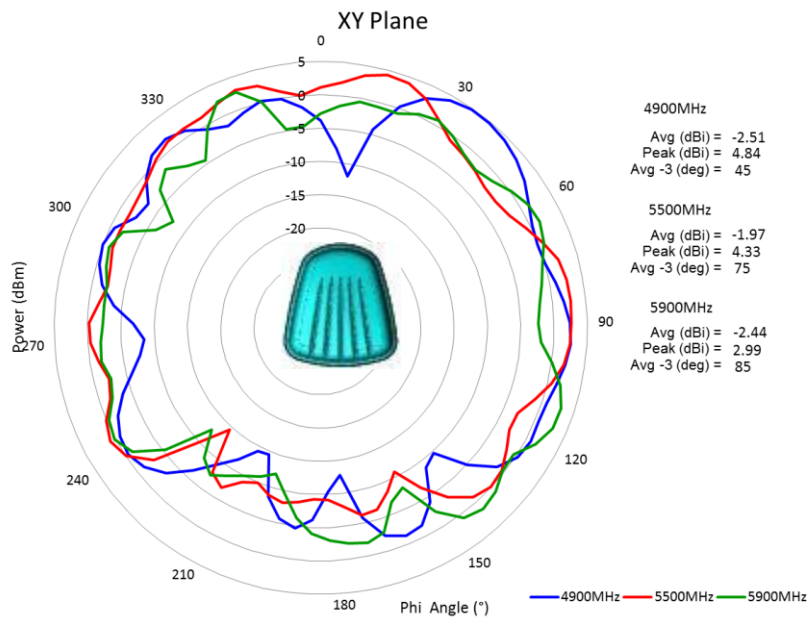

WiFi1 antenna Z-X plane radiation pattern at WiFi high band**

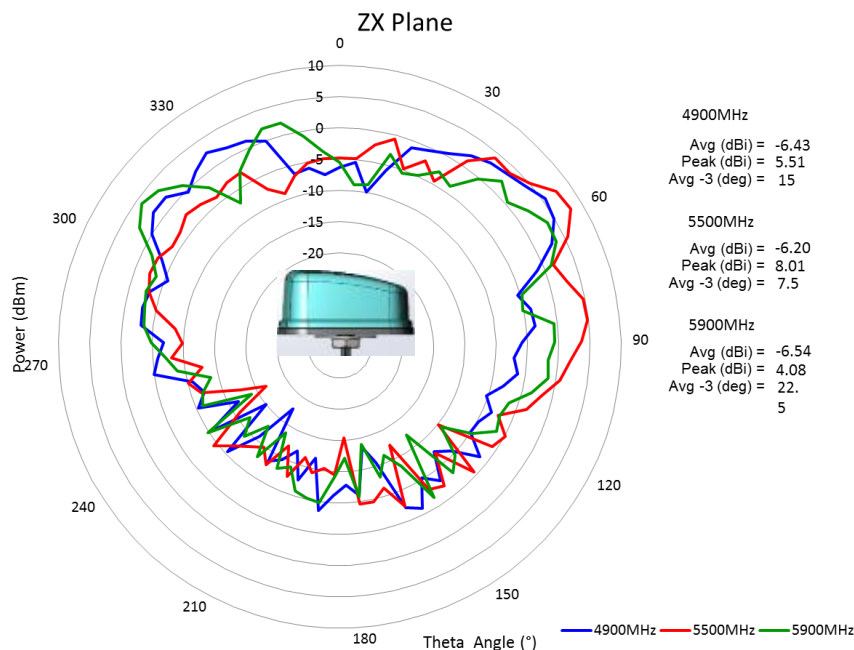

Issue: 1833

In the effort to improve our products, we reserve the right to make changes judged to be necessary.

CONFIDENTIAL AND PROPRIETARY INFORMATION

This document contains confidential and proprietary information of Pulse Electronics, Inc. (Pulse) and is protected by copyright, trade secret and other state and federal laws. Its receipt or possession does not convey any rights to reproduce, disclose its contents, or to manufacture, use or sell anything it may describe. Reproduction, disclosure or use without specific written authorization of Pulse is strictly forbidden.

CHARTS

WiFi1 antenna Y-Z plane radiation pattern at WiFi high band**

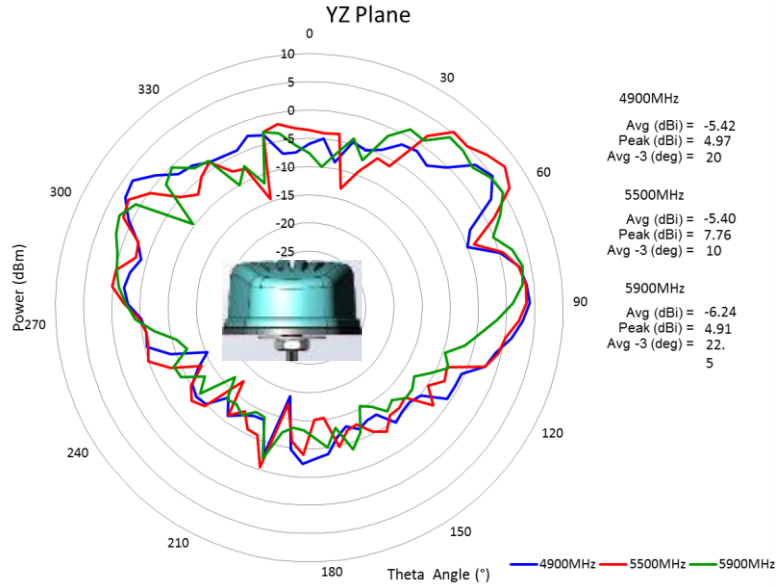

CHARTS

WiFi2 antenna X-Y plane radiation pattern at WiFi low band**

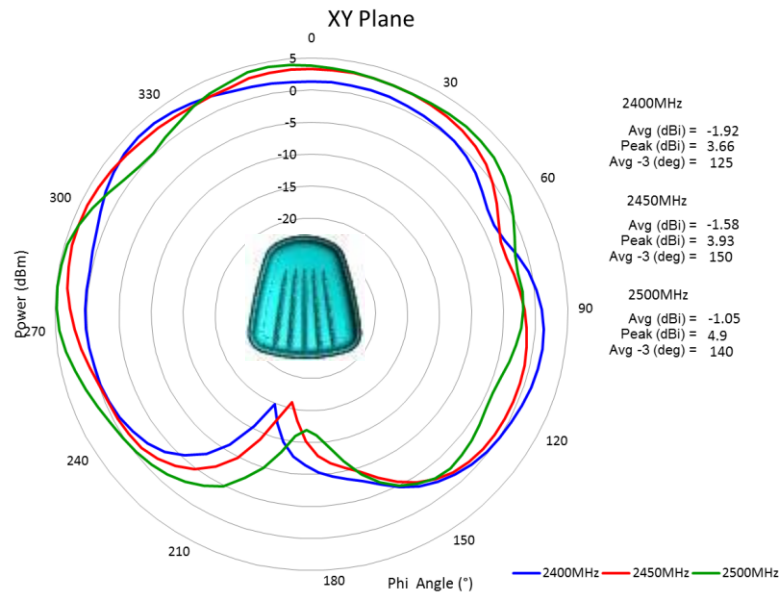

WiFi2 antenna Z-X plane radiation pattern at WiFi low band**

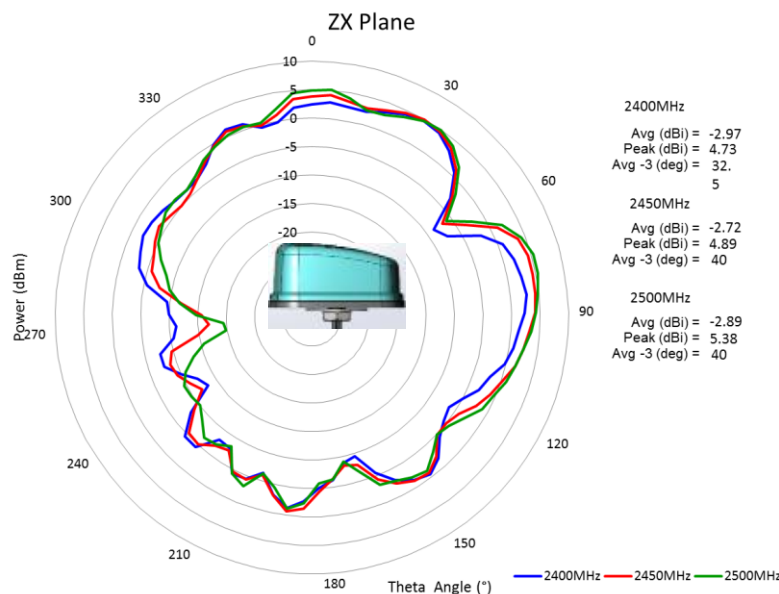

Issue: 1833

In the effort to improve our products, we reserve the right to make changes judged to be necessary.

CONFIDENTIAL AND PROPRIETARY INFORMATION

This document contains confidential and proprietary information of Pulse Electronics, Inc. (Pulse) and is protected by copyright, trade secret and other state and federal laws. Its receipt or possession does not convey any rights to reproduce, disclose its contents, or to manufacture, use or sell anything it may describe. Reproduction, disclosure or use without specific written authorization of Pulse is strictly forbidden.

CHARTS

WiFi2 antenna Y-Z plane radiation pattern at WiFi low band**

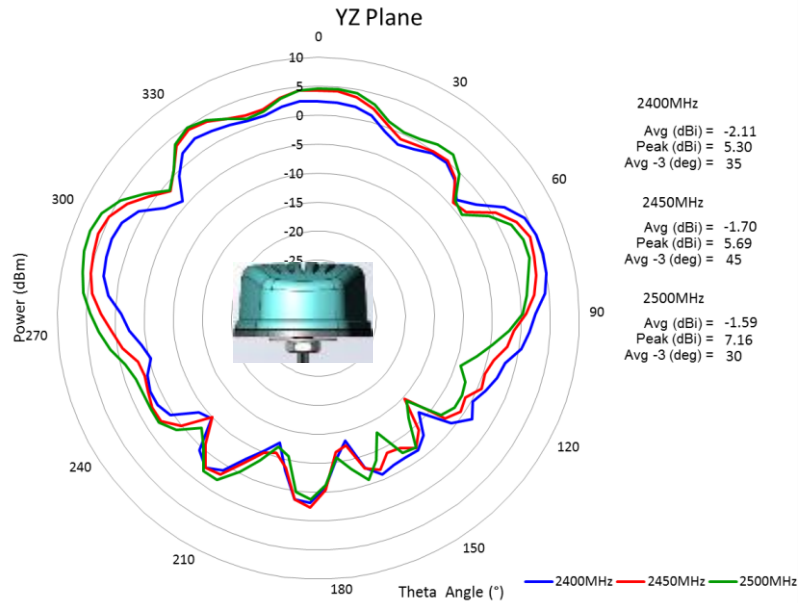

CHARTS

WiFi2 antenna X-Y plane radiation pattern at WiFi high band**

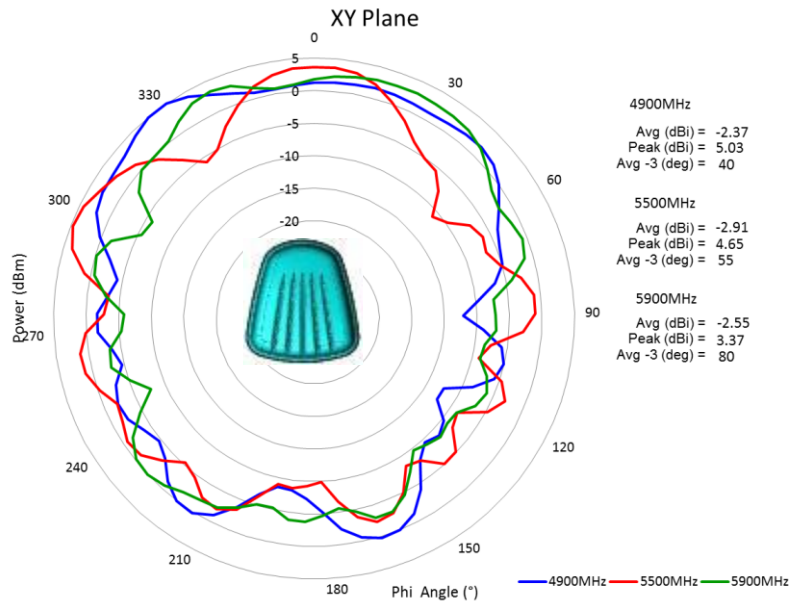

WiFi2 antenna Z-X plane radiation pattern at WiFi high band**

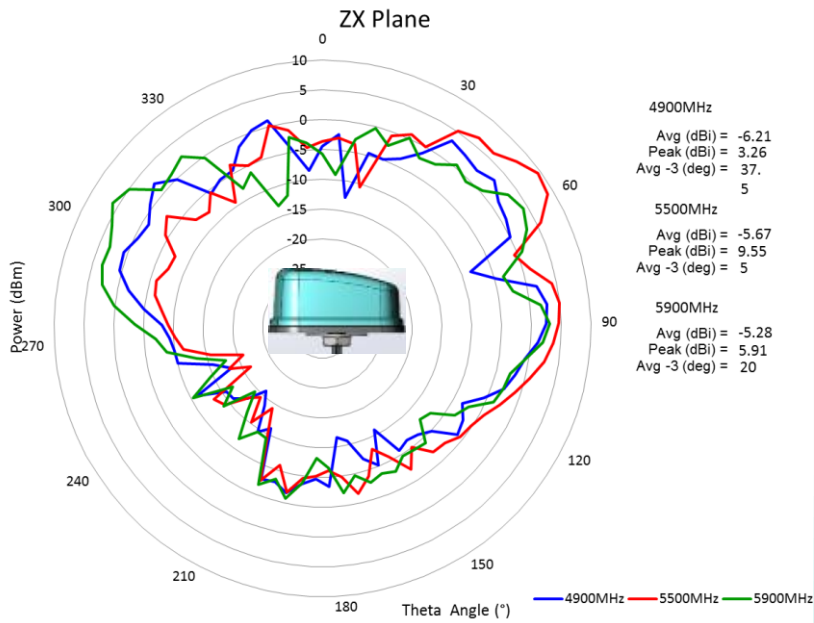

Issue: 1833

In the effort to improve our products, we reserve the right to make changes judged to be necessary.

CONFIDENTIAL AND PROPRIETARY INFORMATION

This document contains confidential and proprietary information of Pulse Electronics, Inc. (Pulse) and is protected by copyright, trade secret and other state and federal laws. Its receipt or possession does not convey any rights to reproduce, disclose its contents, or to manufacture, use or sell anything it may describe. Reproduction, disclosure or use without specific written authorization of Pulse is strictly forbidden.

CHARTS

WiFi2 antenna Y-Z plane radiation pattern at WiFi high band**

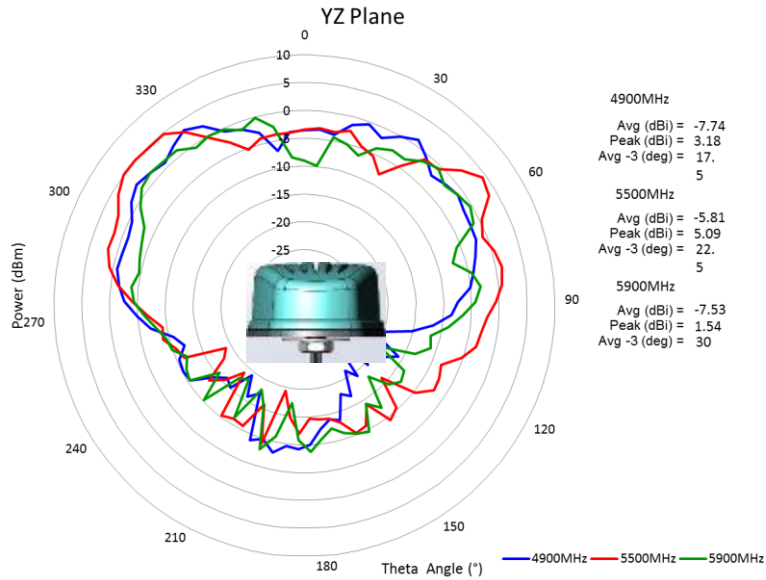

CHARTS

WiFi3 antenna X-Y plane radiation pattern at WiFi low band**

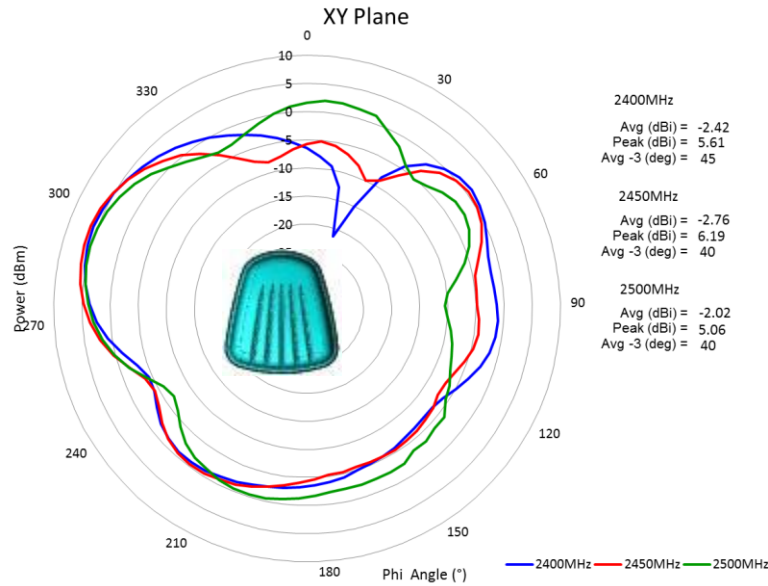

WiFi3 antenna Z-X plane radiation pattern at WiFi low band**

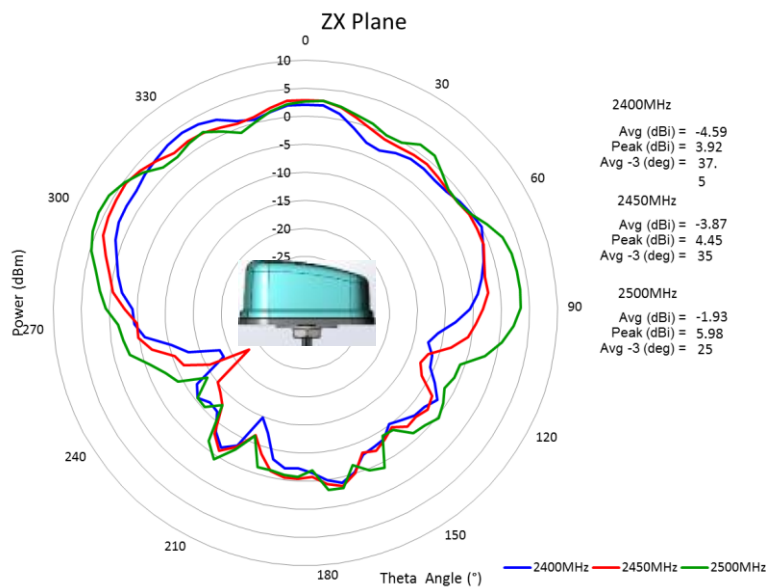

Issue: 1833

In the effort to improve our products, we reserve the right to make changes judged to be necessary.

CONFIDENTIAL AND PROPRIETARY INFORMATION

This document contains confidential and proprietary information of Pulse Electronics, Inc. (Pulse) and is protected by copyright, trade secret and other state and federal laws. Its receipt or possession does not convey any rights to reproduce, disclose its contents, or to manufacture, use or sell anything it may describe. Reproduction, disclosure or use without specific written authorization of Pulse is strictly forbidden.

CHARTS

WiFi3 antenna Y-Z plane radiation pattern at WiFi low band**

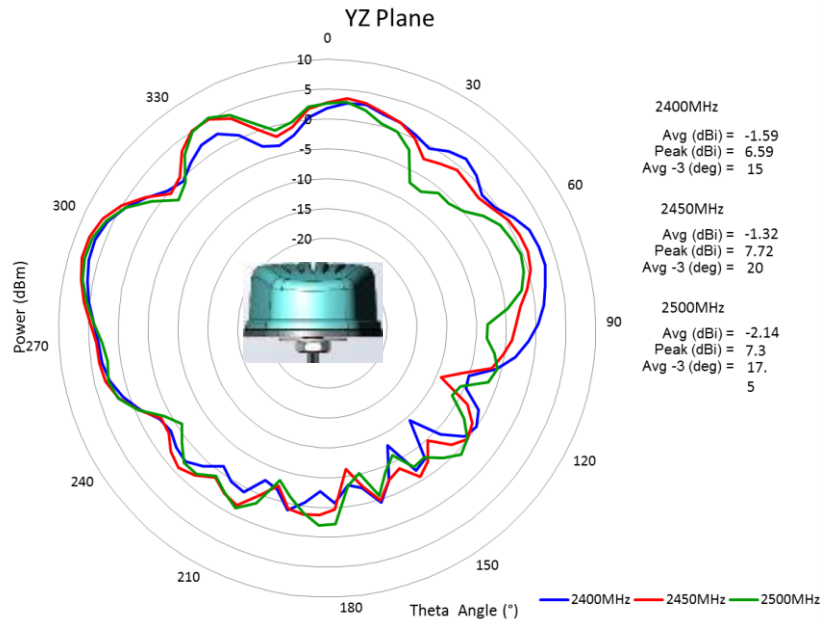

CHARTS

WiFi3 antenna X-Y plane radiation pattern at WiFi high band**

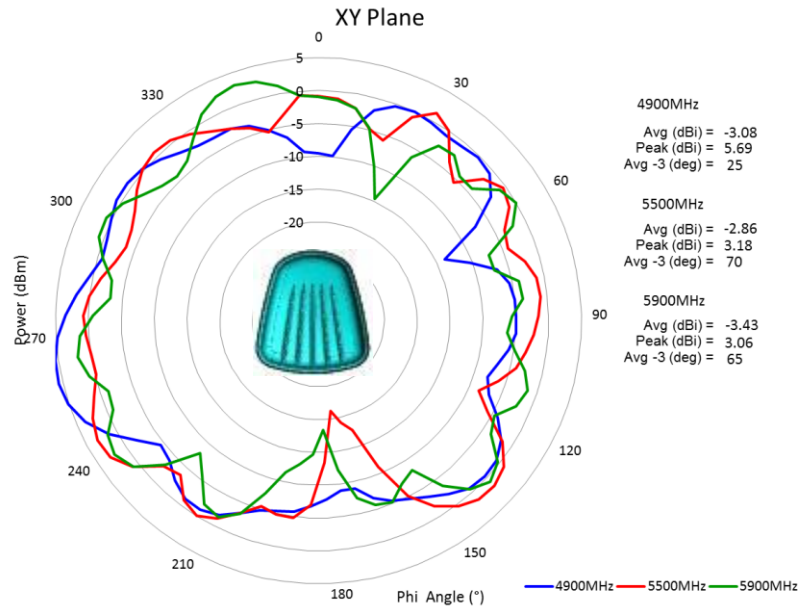

WiFi3 antenna Z-X plane radiation pattern at WiFi high band**

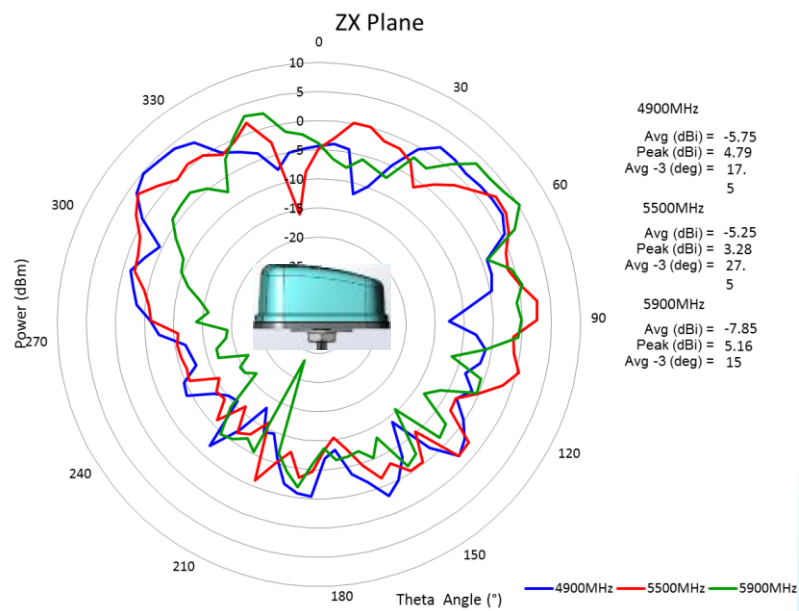

Issue: 1833

In the effort to improve our products, we reserve the right to make changes judged to be necessary.

CONFIDENTIAL AND PROPRIETARY INFORMATION

This document contains confidential and proprietary information of Pulse Electronics, Inc. (Pulse) and is protected by copyright, trade secret and other state and federal laws. Its receipt or possession does not convey any rights to reproduce, disclose its contents, or to manufacture, use or sell anything it may describe. Reproduction, disclosure or use without specific written authorization of Pulse is strictly forbidden.

CHARTS

WiFi3 antenna Y-Z plane radiation pattern at WiFi high band**

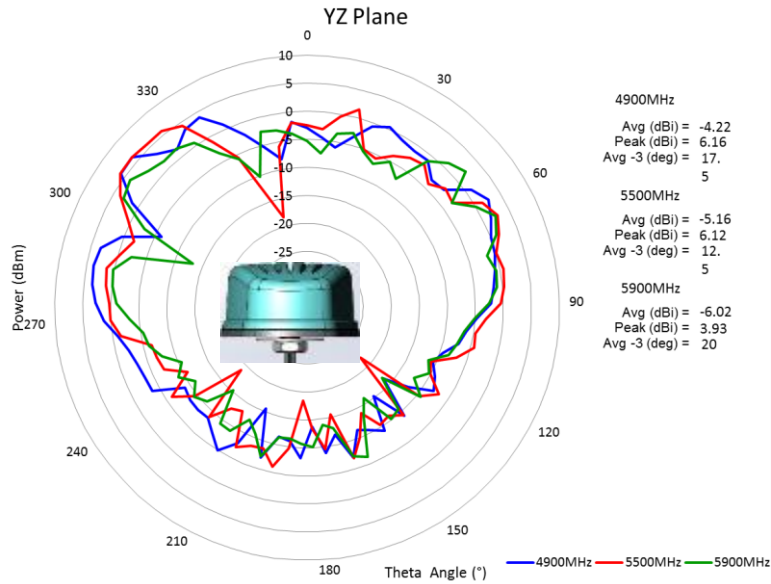

CHARTS

GNSS antenna, BD2 RHCP patterns, in free space*

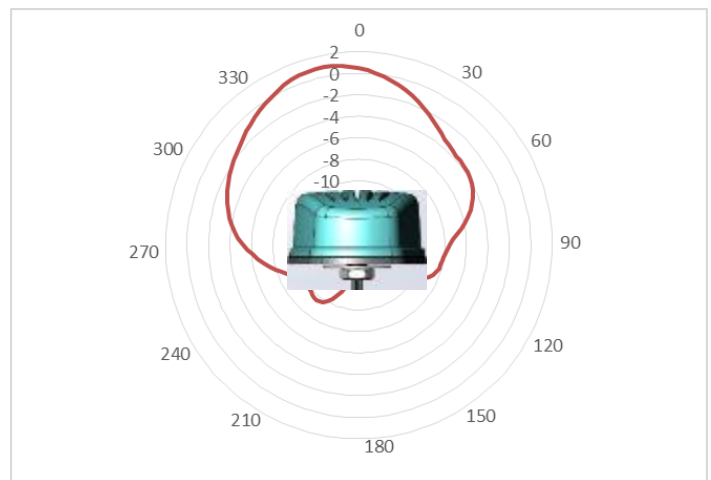
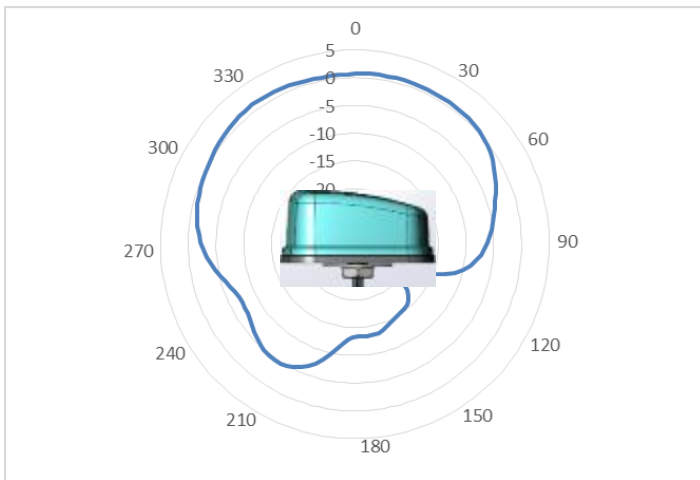

GNSS antenna, GPS & Galileo RHCP patterns, in free space*

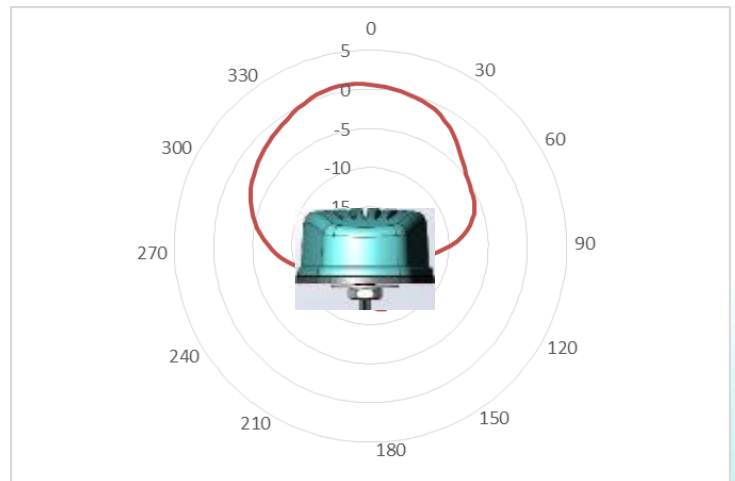
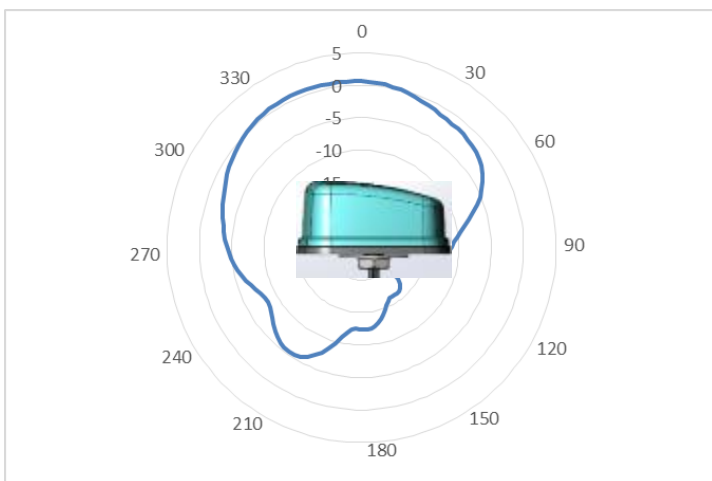

CHARTS

GNSS antenna, GLONASS RHCP patterns, in free space*

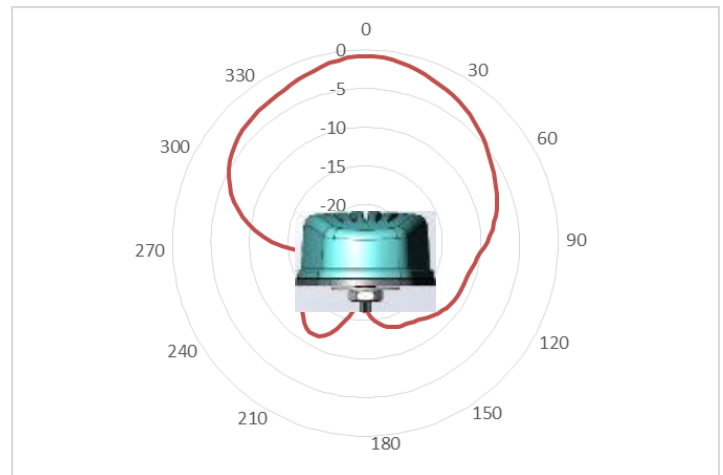
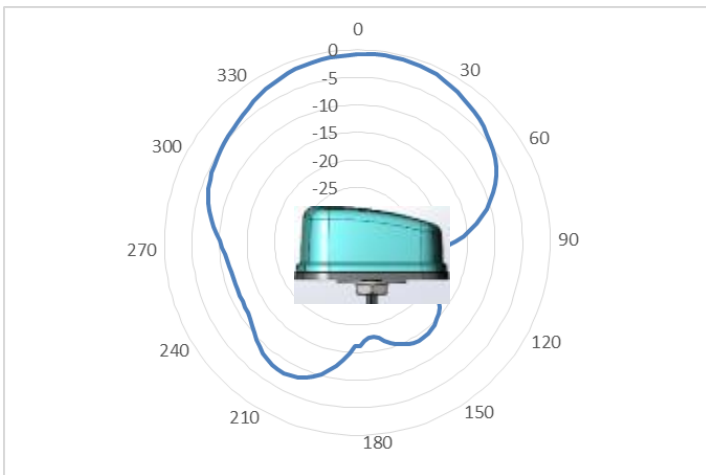

**Description: 2xMiMo LTE, 3xMiMo WiFi,
GNSS Vehicle Mount Antenna**

Series: Panther

**PART NUMBER: PAN62311DM, PAN62312DM,
PAN62311DMR, PAN62312DMR**

PACKAGING

One antenna pack in one PE bag, 6 antennas in one box

单击下面可查看定价，库存，交付和生命周期等信息

[>>Pulse\(普思\)](#)