

850/1900MHz Dual Band Diversity RX Ceramic Antenna

Ceramic Chip Antenna. PWB ground removal area under antenna 12.80 x 6.25 mm. Pulse Part Number: W3047A

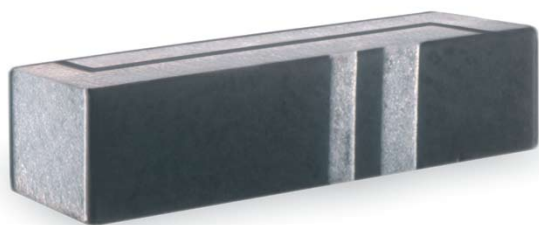

Features

- PIFA antenna
- Dual band operation, single feed point
- SMD compatible
- Lead free materials
- Size W x L x H (12 x 3 x 3 mm)
- Weight: 530 mg
- RoHS Compliant

Applications

- Dual band US GSM Rx
- 850MHz/1900MHz Rx

W3047A Dual band diversity antenna typical performance @ +25 °C

Note: Performance figures are measured when antenna is mounted on Pulse evaluation board

Frequency Range [MHz]	Efficiency [%] / [dB]	Impedance [Ω]
869-894	50 / -3 (peak)	50
1930-1990	70 / -1,55 (peak)	

Pulse Finland Oy

Takatie 6
90440 Kempele, Finland
Tel: +358 207 935 500
Fax: +358 207 935 501
www.pulseeng.com/antennas



850/1900MHz Dual Band Diversity RX Ceramic Antenna

Ceramic Chip Antenna. PWB ground removal area under antenna 12.80 x 6.25 mm. Pulse Part Number: W3047A

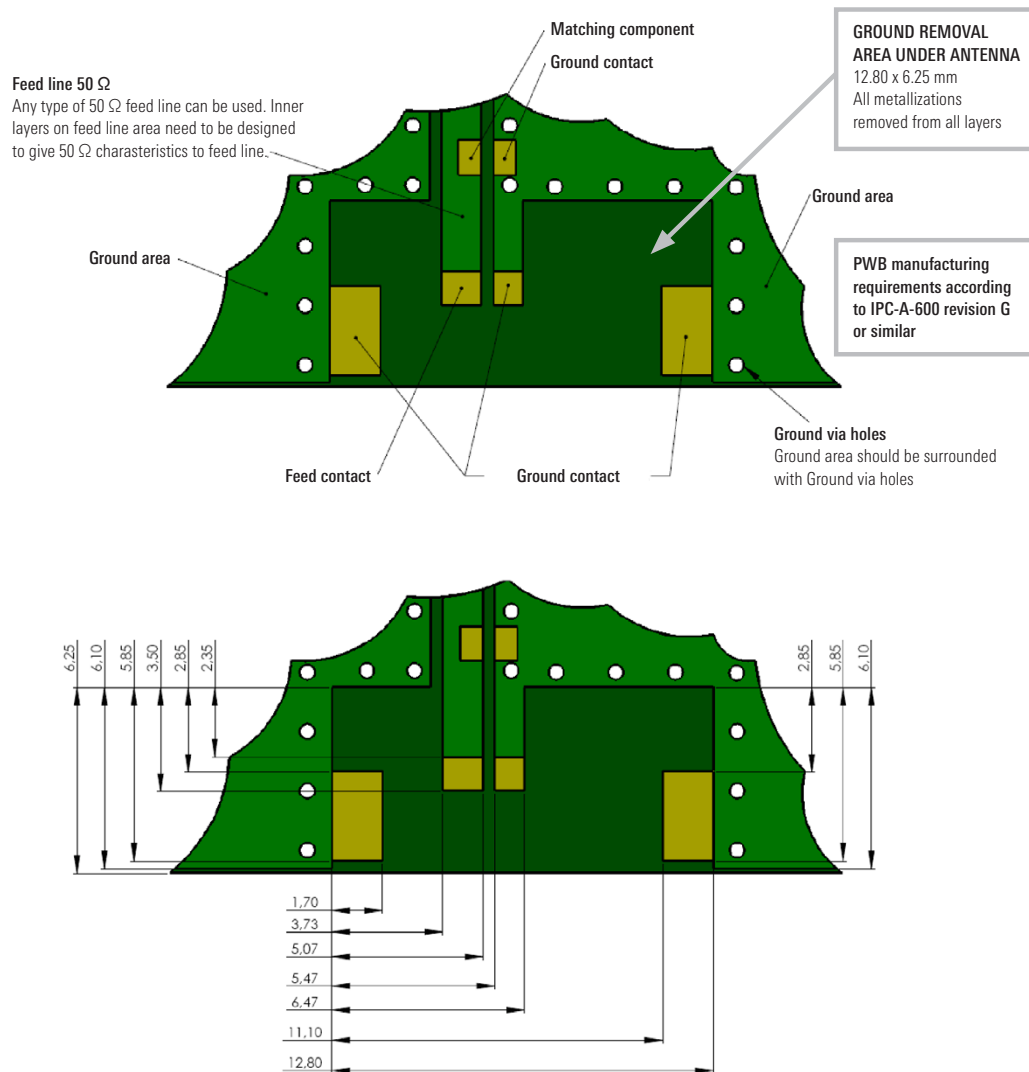

Recommended Antenna Pad Dimensions on PWB Layout (top surface)

No.	Terminal Name	Terminal Dimensions [mm]
1	Feed	1.34 x 1.15
2	GND	1.00 x 1.15
3	GND	3.00 x 1.70
4	GND	3.00 x 1.70

Pulse Finland Oy

Takatie 6
90440 Kempele, Finland
Tel: +358 207 935 500
Fax: +358 207 935 501

www.pulseeng.com/antennas



© 2008. All Rights Reserved.

850/1900MHz Dual Band Diversity RX Ceramic Antenna

Ceramic Chip Antenna. PWB ground removal area under antenna 12.80 x 6.25 mm. Pulse Part Number: W3047A

Recommended ground clearance area under antenna on PWB (bottom surface)

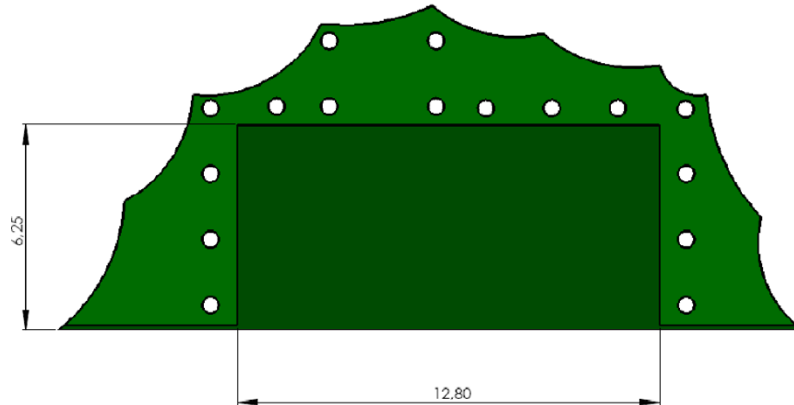

3D-view of test setup

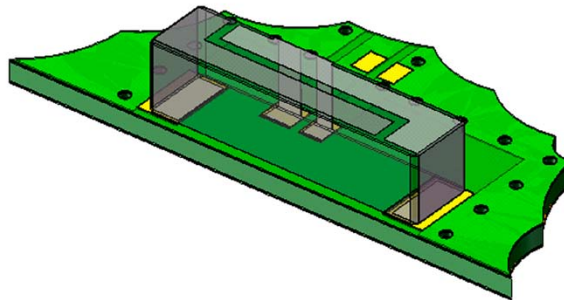

Pulse Finland Oy

Takatie 6
90440 Kempele, Finland

Tel: +358 207 935 500

Fax: +358 207 935 501

www.pulseeng.com/antennas



© 2008. All Rights Reserved.

850/1900MHz Dual Band Diversity RX Ceramic Antenna

Ceramic Chip Antenna. PWB ground removal area under antenna 12.80 x 6.25 mm. Pulse Part Number: W3047A

W3047A Dual band diversity antenna typical Return Loss and Smith chart

Antenna location is on side center of 40x100mm Pulse evaluation board

W3047A

2 Oct 2009 13:48:24

CH1Markers

1. -2.1806 dB 869.000 MHz
2. -11.348 dB 881.000 MHz
3. -2.0187 dB 894.000 MHz
4. -7.8819 dB 1.93000 GHz
5. -8.3618 dB 1.99000 GHz

CH1 S11&LOG

3 dB/REF 0 dB

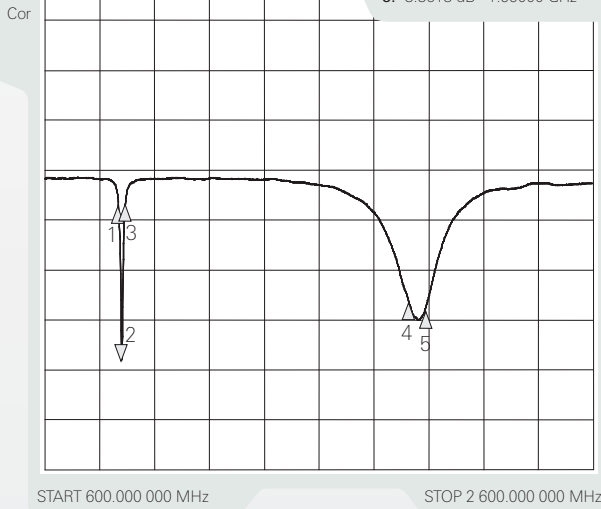

W3047A

2 Oct 2009 13:48:08

- | | | |
|-------------|-----------|-------------|
| 1. 14.805 Ω | 56.750 Ω | 869.000 MHz |
| 2. 59.309 Ω | -27.367 Ω | 6.6011 pF |
| 3. 5.8682 Ω | 2.4009 Ω | 894.000 MHz |
| 4. 44.785 Ω | -43.000 Ω | 1.93000 GHz |
| 5. 22.369 Ω | -8.9463 Ω | 1.99000 GHz |

CH1 S11 1 U FS

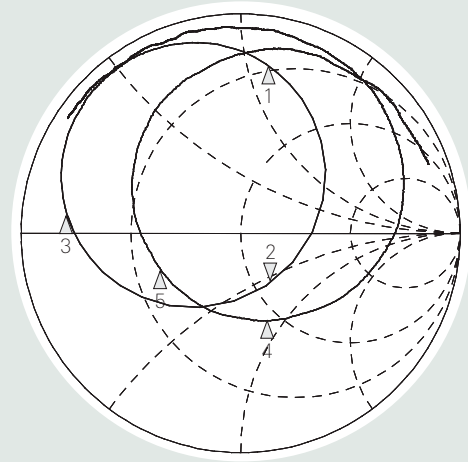

W3047A Efficiency

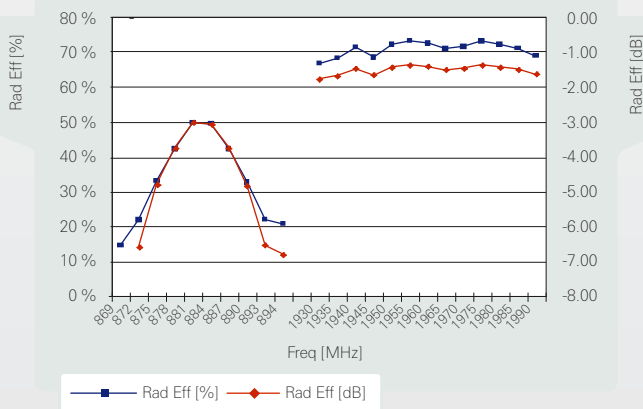

W3047A Gain

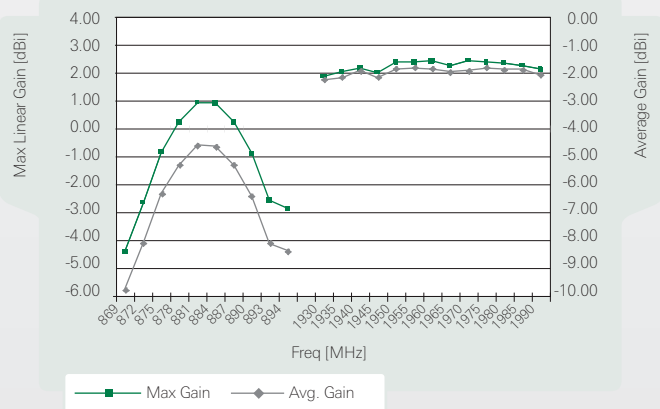

Pulse Finland Oy

Takatie 6
90440 Kempele, Finland
Tel: +358 207 935 500
Fax: +358 207 935 501
www.pulseeng.com/antennas



850/1900MHz Dual Band Diversity RX Ceramic Antenna

Ceramic Chip Antenna. PWB ground removal area under antenna 12.80 x 6.25 mm. Pulse Part Number: W3047A

General

Tape and reel packing is used. Carrier tape, reel and box dimensions are presented in following pictures.

Carrier tape

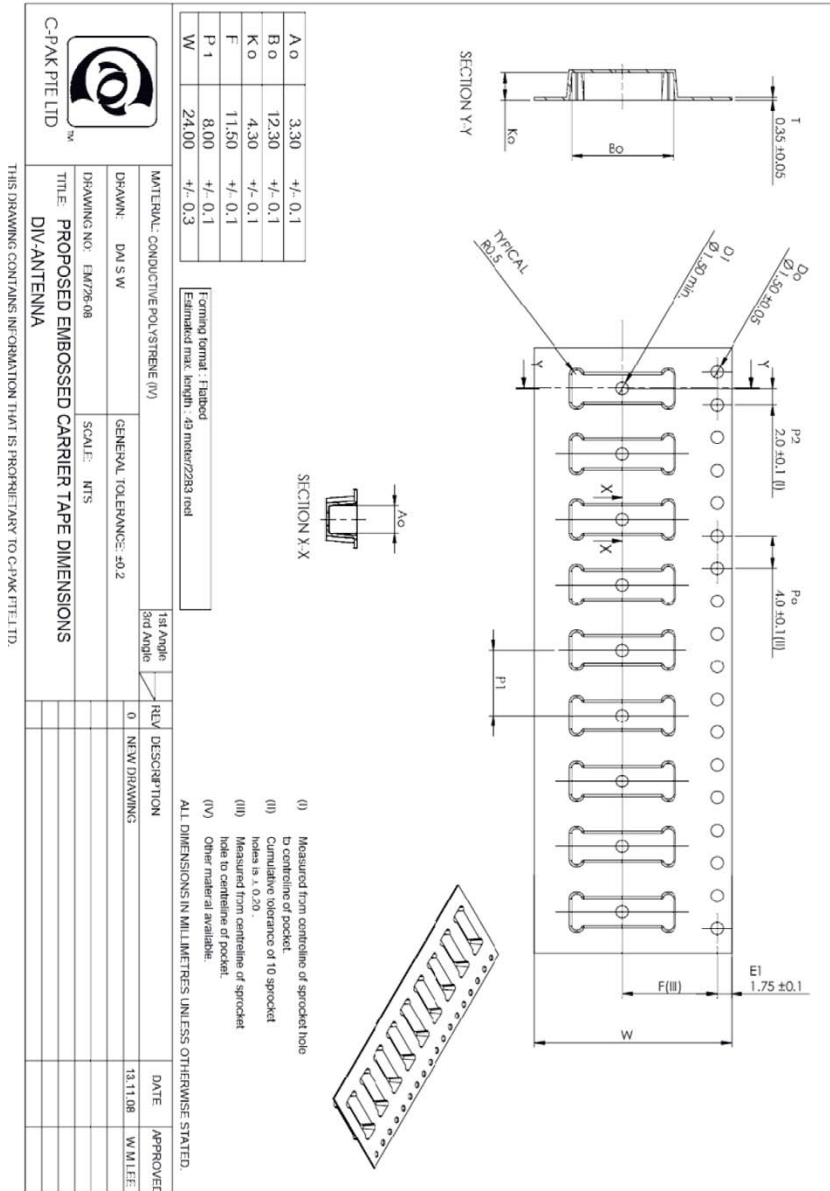

Pulse Finland Oy

Takatie 6
 90440 Kempele, Finland
 Tel: +358 207 935 500
 Fax: +358 207 935 501
www.pulseeng.com/antennas



© 2008. All Rights Reserved.

850/1900MHz Dual Band Diversity RX Ceramic Antenna

Ceramic Chip Antenna. PWB ground removal area under antenna 12.80 x 6.25 mm. Pulse Part Number: W3047A

Block orientation

Antenna soldering pads facing down to the bottom of the carrier tape.

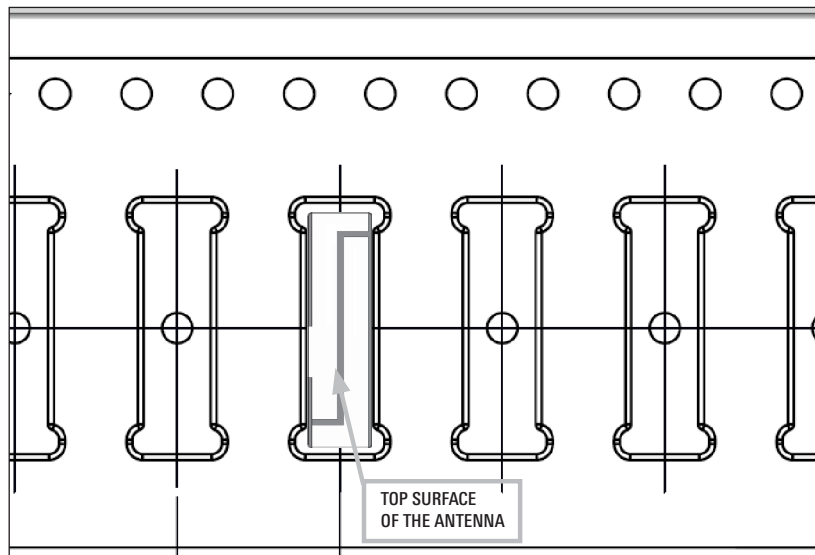

Top View of the Carrier Tape

Pulse Finland Oy

Takatie 6
90440 Kempele, Finland
Tel: +358 207 935 500
Fax: +358 207 935 501
www.pulseeng.com/antennas



850/1900MHz Dual Band Diversity RX Ceramic Antenna

Ceramic Chip Antenna. PWB ground removal area under antenna 12.80 x 6.25 mm. Pulse Part Number: W3047A

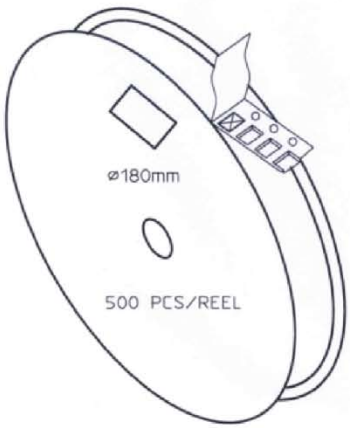

ø180mm
500 PCS/REEL

CARRIER TAPE H85-00201
width=24,00 depth=4.30
COVER TAPE H85-00195
width=21.20

LENGTH OF TAPE:

- Leader section: min 350 mm before component section
- Trailer section: min 40 mm after component section.

Empty part cavities at leader and trailer section of the tape must be sealed with top cover tape.

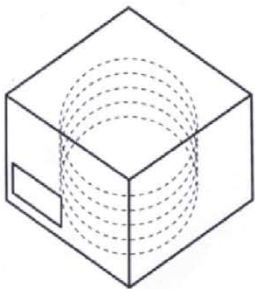

BOX H85-00128 1 pcs
(182x182x125)
- LABEL 1 pcs/BOX

REEL H85-00196 4 pcs
(D180, W28)
- REEL LABEL 1 pcs/REEL

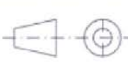
MATERIAL			
HANDLINGS			
		RATIO	
		DRWN	250509 PeHa H
PRODUCT		DGNER	G
		CHKD	F
		APPRD	E
		APPRD BY	D
DENOMINATION	PACKING FORM		C
			B
			A
		VERSION	MOD/DATE/NAME

单击下面可查看定价，库存，交付和生命周期等信息

[>>Pulse\(普思\)](#)