



# 10/100 PC CARD LAN MAGNETICS MODULES



-  RoHS-5 peak reflow temperature rating 235°C
-  RoHS-6 peak reflow temperature rating 245°C
-  Low profile packages from .094" (2,39mm) to .078" (1,98mm) for PC card and cardbus applications

## Electrical Specifications @ 25°C — Operating Temperature 0°C to 70°C

RoHS-5 <sup>3</sup> Compliant Part Number	RoHS-6 <sup>4</sup> Compliant Part Number	Turns Ratio (±5%)		Insertion Loss (dB MAX)	Return Loss (dB MIN)			Differential to Common Mode Rejection (dB MIN)			Crosstalk (dB MIN)			Hipot (Vrms MIN)
		TX	RX		100 kHz-100 MHz	30 MHz	60 MHz	80 MHz	30 MHz	50 MHz	100 MHz	30 MHz	62 MHz	
PE-69012	—	1:1	1:1	-1.3	-18	-13	-11	-40	-35	-30	-40	-40	-35	1500
H0002	—	1:1	1:1	-1.3	-18	-13	-11	-30	-30	-30	-40	-35	-30	1500
H0009	H0009 NL <sup>2a</sup>	1:1	1:1	-0.9	-16	-12	-11	-35	-33	-20	-50	-45	-40	1500
H0013	H0013 NL <sup>2a</sup>	1:1	1:1	-0.9	-16	-12	-11	-35	-33	-20	-50	-45	-40	1500
H0019	H0019NL <sup>2a</sup>	1:1	1:1	-0.9	-18	-12	-11	-40	—	-30	-45	-45	-37	1500
H0020	H0020NL <sup>2a</sup>	1:1	1:1	-1.0	-16	-12	-12	-42	—	-33	-45	-40	-35	1500
H0022	H0022NL <sup>2a</sup>	1:1	1:1	-2.0	-18	-14	-12	-40	-35	-30	-50	-45	-40	1500
H0025	H0025NL <sup>2a</sup>	1:1	1:1	-2.0	-18	-12	-12	-40	-35	-30	-45	-45	-37	1500

1. Add "T" for Tape & Reel packaging, e.g. PE-69012T.
2. MSL (Moisture Sensitivity Level): a=1, b=2, c=3, d=4, e=5.
3. **RoHS-5:** Product does not contain 5 out of the 6 banned substances specified in the RoHS directive (product contains lead in applications considered solder).
4. **RoHS-6:** Product does not contain 5 out of the 6 banned substances specified in the RoHS directive. Some internal connections may contain lead in high-temperature solder (solder alloys containing more than 85% lead).

## Mechanicals

### PE-69012

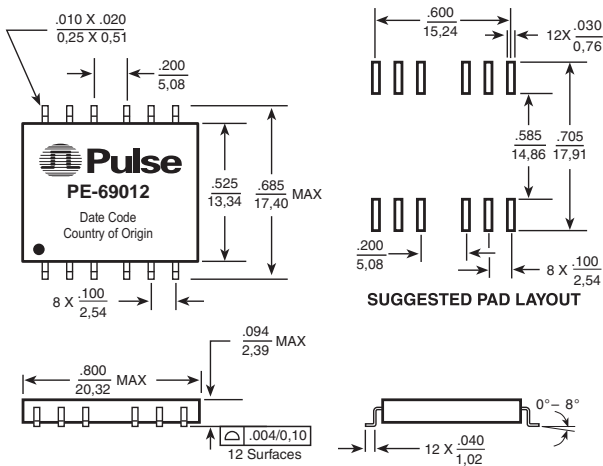

Weight . . . . . 1.3 grams  
Tape & Reel . . . . . .600/reel  
Tube . . . . . .25/tube

### H0002

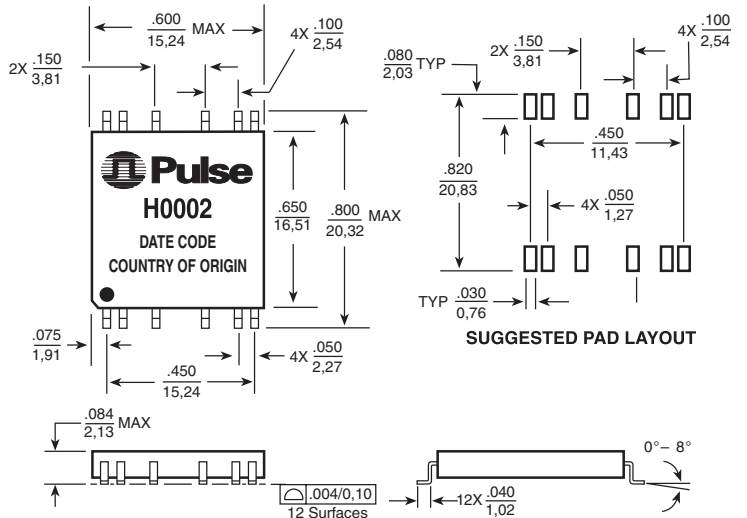

Weight . . . . . 1.2 grams  
Tape & Reel . . . . . .900/reel  
Tube . . . . . .35/tube

Dimensions:  $\frac{\text{Inches}}{\text{mm}}$  Unless otherwise specified, all tolerances are  $\pm \frac{.010}{0.25}$

USA 858 674 8100 • Germany 49 7032 7806 0 • Singapore 65 6287 8998 • Shanghai 86 21 32181071 • China 86 755 33966678 • Taiwan 886 3 4643715

# 10/100 PC CARD LAN MAGNETICS MODULES



## Mechanicals

### H0013, H0019\*

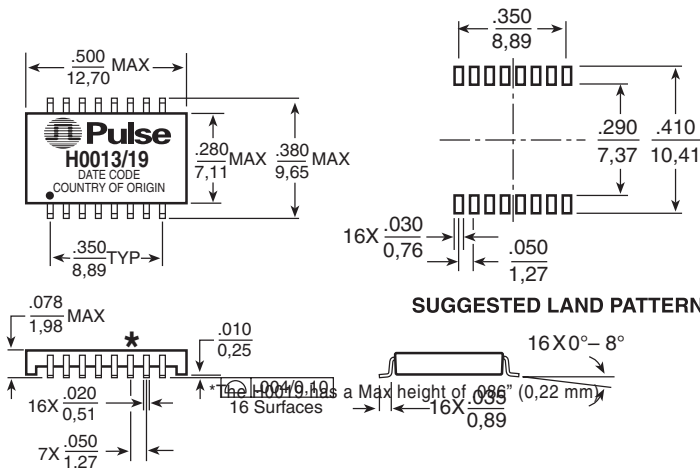

Weight .....3 grams  
Tape & Reel .....2000/reel  
Tube .....40/tube

Dimensions: Inches  
mm

Unless otherwise specified, all tolerances are  $\pm \frac{.010}{0,25}$

### H0009

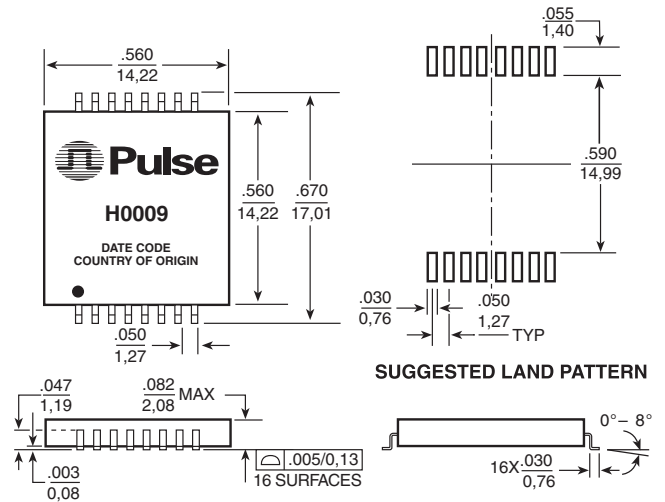

Weight .....1.3 grams  
Tape & Reel .....900/reel  
Tube .....25/tube

### H0020

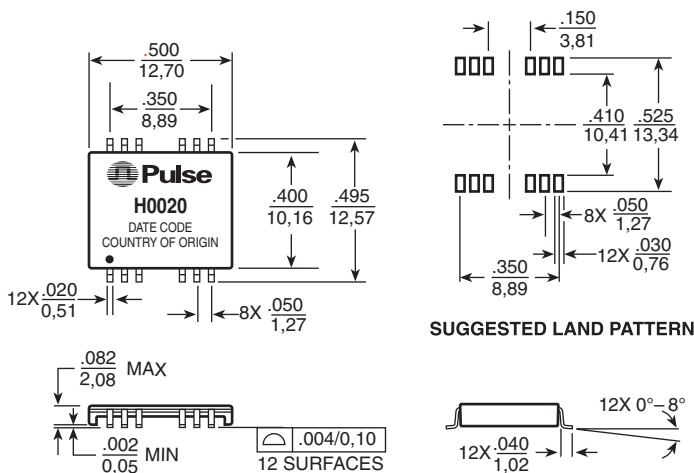

Weight .....4 grams  
Tape & Reel .....500/reel  
Tube .....40/tube

Dimensions: Inches  
mm

Unless otherwise specified, all tolerances are  $\pm \frac{.010}{0,25}$

### H0022, H0025

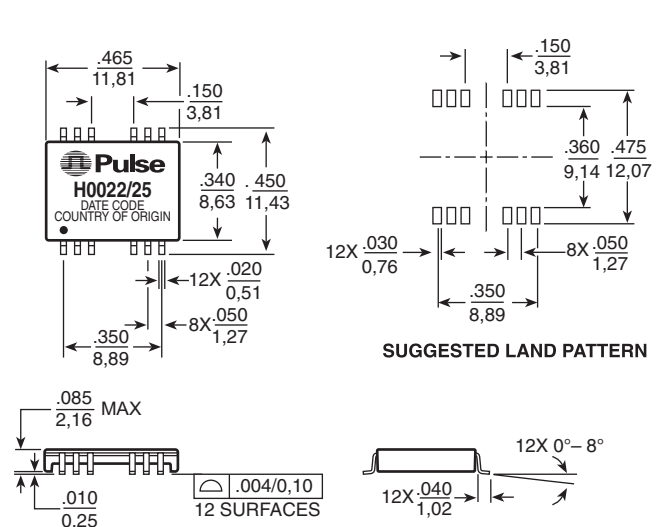

Weight .....355 grams  
Tape & Reel .....1000/reel  
Tube .....40/tube

# 10/100 PC CARD LAN MAGNETICS MODULES



## Schematics

**PE-69012**

**RECEIVE**

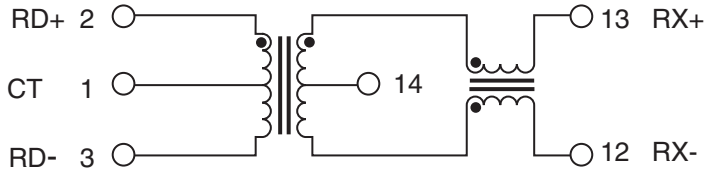

**TRANSMIT**

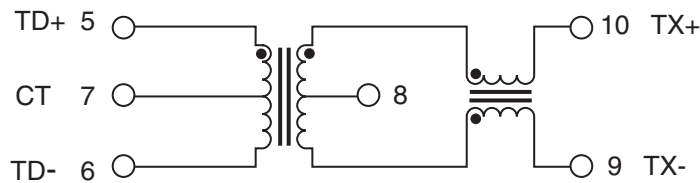

**H0002**

**TRANSMIT**

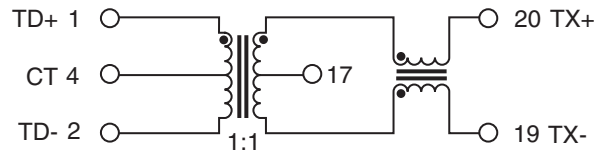

**RECEIVE**

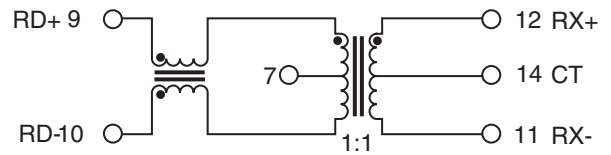

NOTE: Transmit and receive channels are interchangeable on the PE-69012.

**H0009, H0013,  
H0019, H0025**

**RECEIVE**

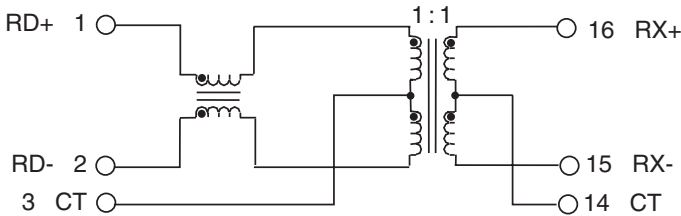

**TRANSMIT**

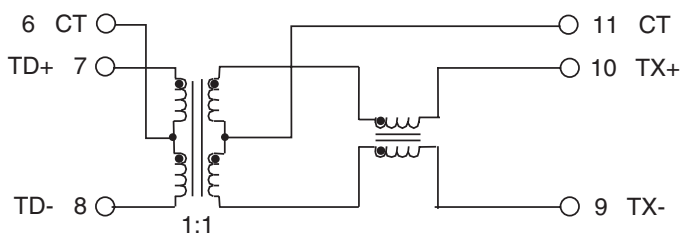

**H0020**

**TRANSMIT**

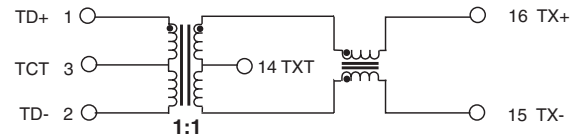

**RECEIVE**

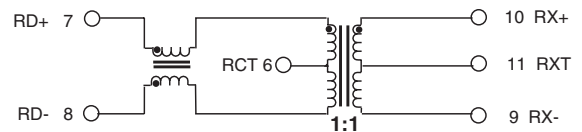

**H0022**

**RECEIVE**

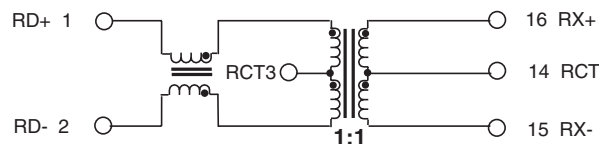

**TRANSMIT**

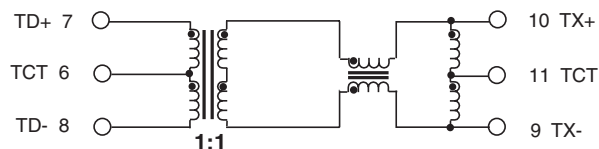

# 10/100 PC CARD LAN MAGNETICS MODULES



## Application Circuits

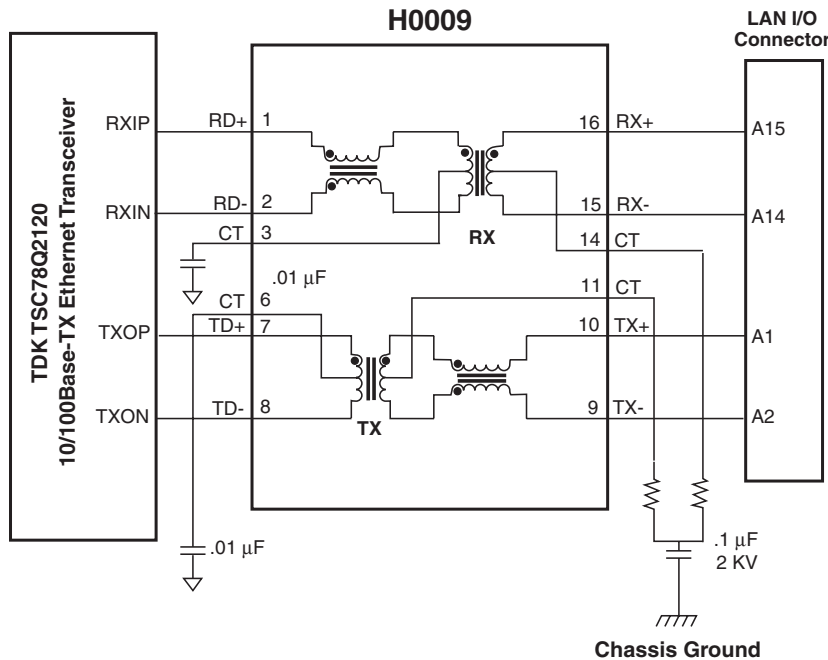
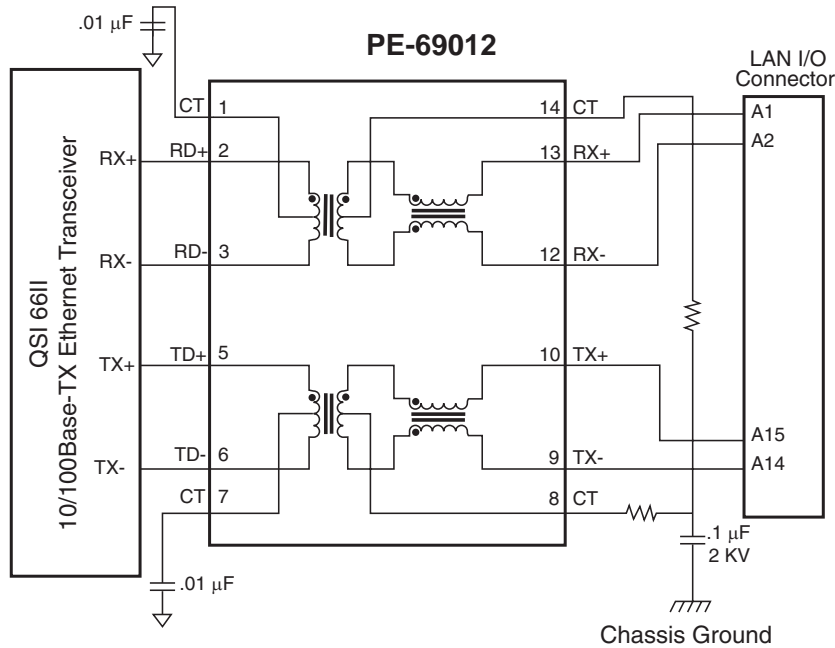

### For More Information:

**Pulse Worldwide Headquarters**  
12220 World Trade Dr.  
San Diego, CA 92128  
U.S.A.

**Pulse Europe**  
Einsteinstrasse 1  
D-71083 Herrenberg  
Germany

**Pulse China Headquarters**  
B402, Shenzhen Academy of  
Aerospace Technology Bldg.  
10th Kejinan Rd.  
High-Tech Zone  
Nanshan District  
Shenzhen, PR China 518057

**Pulse North China**  
Room 1503  
XinYin Building  
No. 888 YiShan Rd.  
Shanghai 200233  
China

**Pulse South Asia**  
150 Kampong Ampat  
#07-01/02  
KA Centre  
Singapore 368324

**Pulse North Asia**  
No. 26, Kao Ching Rd.  
Yang Mei Chen  
Taoyuan Hsien  
Taiwan  
R. O. C.

[www.pulseeng.com](http://www.pulseeng.com)

Tel: 858 674 8100  
Fax: 858 674 8262

Tel: 49 7032 7806 0  
Fax: 49 7032 7806 135

TEL: 86 755 33966678  
FAX: 86 755 33966700

Tel: 86 21 54643211/2  
Fax: 86 21 54643210

Tel: 65 6287 8998  
Fax: 65 6280 0080

Tel: 886 3 4643715  
Fax: 886 3 4641911

Performance warranty of products offered on this data sheet is limited to the parameters specified. Data is subject to change without notice. Other brand and product names mentioned herein may be trademarks or registered trademarks of their respective owners.

© Copyright, 2008. Pulse Engineering, Inc. All rights reserved.

[www.pulseeng.com](http://www.pulseeng.com)

单击下面可查看定价，库存，交付和生命周期等信息

[>>Pulse\(普思\)](#)