

NOTES:

1. ROHS COMPLIANT
2. STORAGE TEMPERATURE: -50°C TO +125°C
3. COMPLIANCE TO J-STD:
 - A. J-STD-002: SOLDERABILITY AT 245°C REFLOW PROFILE
 - B. J-STD-020: LEVEL 1, NO MOISTURE SENSITIVE
 - C. J-STD-075: R7, 245°C MAXIMUM THROUGH REFLOW SOLDER
4. TO ORDER TAPE & REEL PACKAGING ADD A "T" SUFFIX TO THE PART NUMBER(i.e HXXXXXXNL BECOMES HXXXXXXNLT).

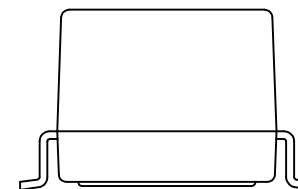
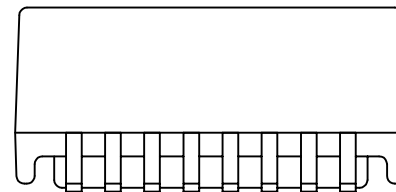
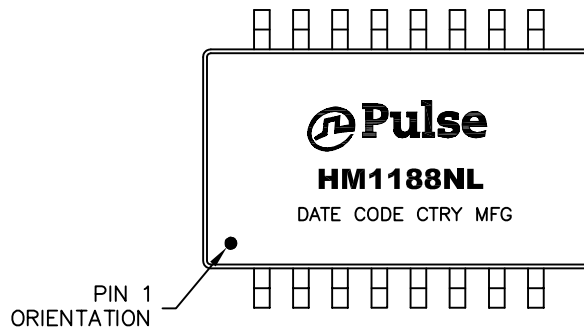

FINAL OUTLINE

© Copyright, 2016. Pulse Electronics Corp. All rights reserved. Pulse confidential & proprietary. (09/05/16)

PRODUCT DESCRIPTION	TLA DRAWING	PS DRAWING	SHEET	PART NO.	DATASHEET REV.
MDL,SIN,100D,1:1,SM,TU	HM1188NL-10	PS-2005.001-F	1 OF 3	HM1188NL	E

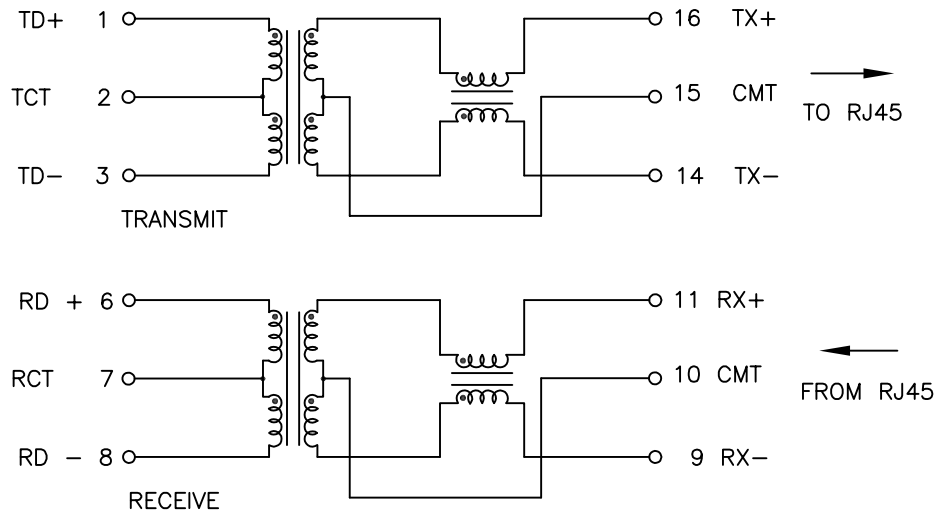

SCHMATIC

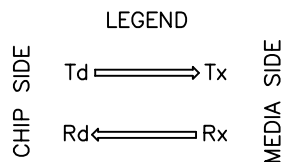

ALL CHANNELS IN
PHASE INPUT TO
OUTPUT

ELECTRICAL CHARACTERISTICS AT +25°C UNLESS OTHER SPECIFIED
MEETS IEEE 802.3 SPECIFICATION

PARAMETER	SPECIFICATIONS	
OPERATING TEMP	-40°C TO +105°C	
URNS RATIO	1 : 1 ±2%	
POLARITY	PER SCHEMATIC	
INDUCTANCE (OCL) (MEDIA SIDE, -40°C~+105°C)	350 uH MIN (MEASURED AT 100 KHz, 100 mVRMS) (AND WITH 8 mA DC BIAS)	
INSERTION LOSS	1-100 MHz	125 MHz
	-1.0 dB MAX	-3.0 dB MAX
RETURN LOSS Z _{OUT} = 100 OHMS	5 MHz	30-80 MHz
	-18 dB MIN	-16 + 26LOG ₁₀ (f/30 MHz) dB MIN
CROSSTALK (TX-RX)	1 MHz	5-100 MHz
	-62 dB MIN	-45 + 21LOG ₁₀ (f/30 MHz) dB MIN
DIFFERENTIAL TO COMMON MODE REJECTION	5-200 MHz	
	-50 + 17LOG ₁₀ (f/5 MHz) dB MIN	
INPUT - OUTPUT ISOLATION	1500 VAC MINIMUM FOR 60 SECONDS	

© Copyright, 2016. Pulse Electronics Corp. All rights reserved. Pulse confidential & proprietary. (09/05/16)

PRODUCT DESCRIPTION
MDL,SIN,100D,1:1,SM,TU

TLA DRAWING
HM1188NL-10

PS DRAWING
PS-2005.001-F

SHEET
2 OF 3

PART NO.
HM1188NL

DATASHEET REV.
E

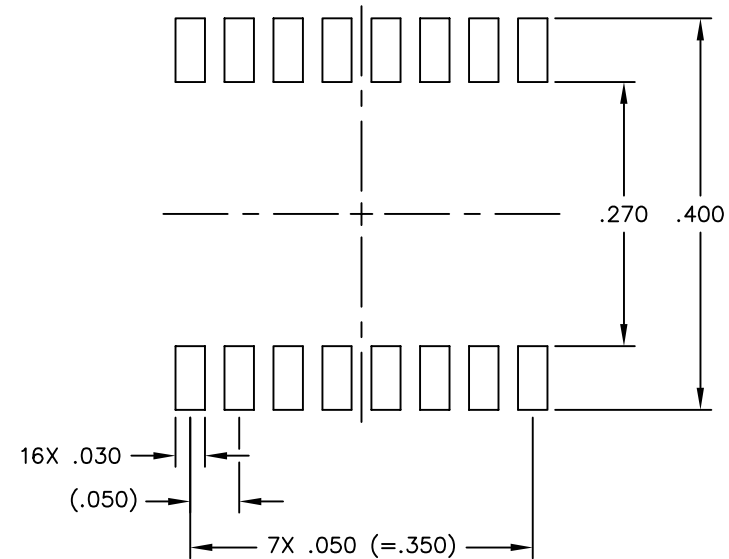
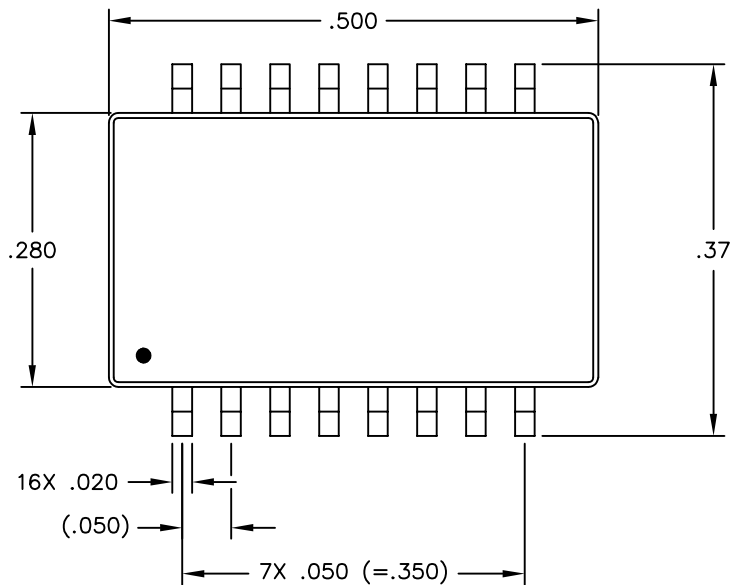

SUGGESTED LAND PATTERN

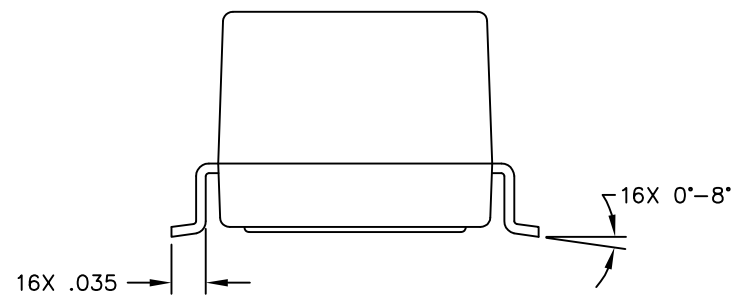
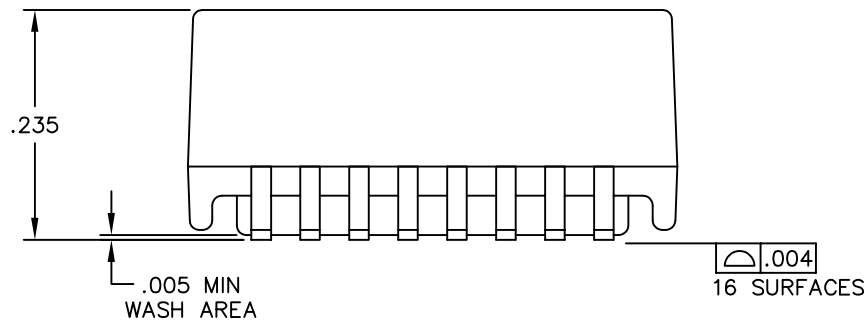

DIMENSIONS ARE IN INCHES WITH THE FOLLOWING TOLERANCES:
 .XX= ±.01
 .XXX= ±.005

© Copyright, 2016. Pulse Electronics Corp. All rights reserved. Pulse confidential & proprietary. (09/05/16)

PRODUCT DESCRIPTION
MDL,SIN,100D,1:1,SM,TU

TLA DRAWING
HM1188NL-10

PS DRAWING
PS-2005.001-F

SHEET
3 OF 3

PART NO.
HM1188NL

DATASHEET REV.
E

单击下面可查看定价，库存，交付和生命周期等信息

[>>Pulse\(普思\)](#)