

NOTES:

1. ROHS COMPLIANT
2. STORAGE TEMPERATURE: -50°C TO +125°C
3. COMPLIANCE TO J-STD:
 - A. J-STD-002: SOLDERABILITY AT 245°C REFLOW PROFILE
 - B. J-STD-020: LEVEL 1, NO MOISTURE SENSITIVE
 - C. J-STD-075: R7, 245°C MAXIMUM THROUGH REFLOW SOLDER
4. TO ORDER TAPE & REEL PACKAGING ADD A "T" SUFFIX TO THE PART NUMBER(i.e HXXXXXXXXNL BECOMES HXXXXXXXXNLT).
5. MEETS AEC-Q200 REQUIREMENTS

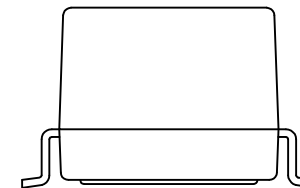
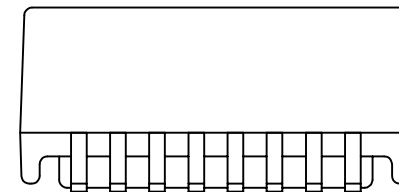
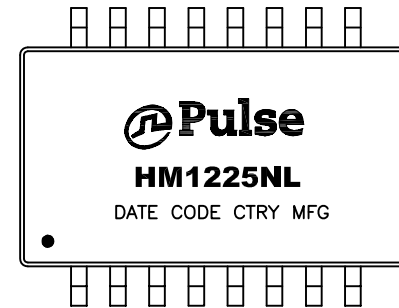

FINAL OUTLINE

© Copyright, 2016. Pulse Electronics Corp. All rights reserved. Pulse confidential & proprietary. (09/14/16)

PRODUCT DESCRIPTION	TLA DRAWING	PS DRAWING	SHEET	PART NO.	DATASHEET REV.
MDL,SIN,100D,1:1/1.5:1,SM,TU	HM1225NL-10	PS-2005.001-F	1 OF 3	HM1225NL	C

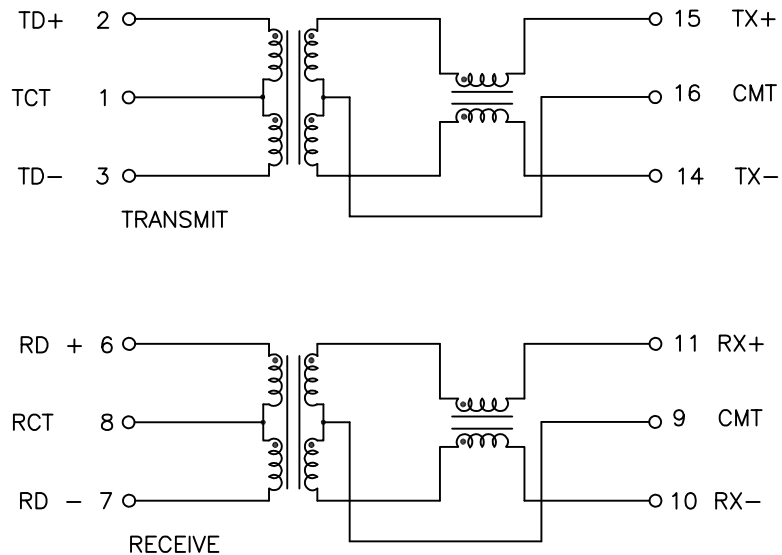

SCHEMATIC

ELECTRICAL CHARACTERISTICS AT +25°C UNLESS OTHERWISE SPECIFIED
(FOR REFERENCE ONLY. USED FOR CUSTOMER INFORMATION.)

PARAMETER	SPECIFICATIONS							
OPERATING TEMP	-40°C TO +95°C							
URNS RATIO	1 : 1 ±3%							
POLARITY	PER SCHEMATIC							
TRUNS RATIO	TRANSMIT				RECEIVE			
	1:1(±2%)				1.5:1(±2%)			
INSERTION LOSS	1-50 MHz				1-50 MHz			
	-1.0 dB MAX.				-1.5 dB MAX.			
RETURN LOSS Z _{OUT} = 100 OHMS	0.5~40 MHz	60 MHz	80 MHz	0.5MHz	40 MHz	60 MHz	80 MHz	
	-18 dB MIN.	-14.5 dB MIN.	-12 dB MIN.	-18 dB MIN.	-10 dB MIN.	-8 dB MIN.	-6 dB MIN.	
CROSSTALK	30 MHz		60 MHz		100 MHz			
	-45 dB		-35 dB		-30 dB			
	200 uH MIN		MEASURED AT 100 KHz, 100 mVRMS, AT +25 °C					
OCL	100 uH MIN		MEASURED AT 100 KHz, 100 mVRMS, AT -40 °C					
	100 uH MIN		MEASURED AT 100 KHz, 100 mVRMS, AT +95 °C					
C _{ww}	18 pF MAX		MEASURED AT 100 KHz, 100 mVRMS					
ISOLATION (INPUT - OUTPUT)	1650 VRMS, 6 SECONDS MAX							

© Copyright, 2016. Pulse Electronics Corp. All rights reserved. Pulse confidential & proprietary. (09/14/16)

PRODUCT DESCRIPTION

TLA DRAWING

PS DRAWING

SHEET

PART NO.

DATASHEET REV.

MDL,SIN,100D,1:1/1.5:1,SM,TU

HM1225NL-10

PS-2005.001-F

2 OF 3

HM1225NL

C

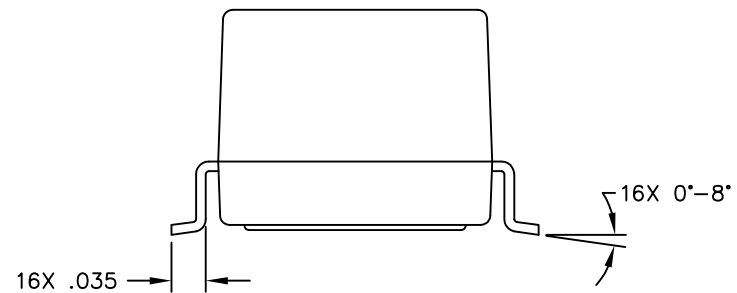
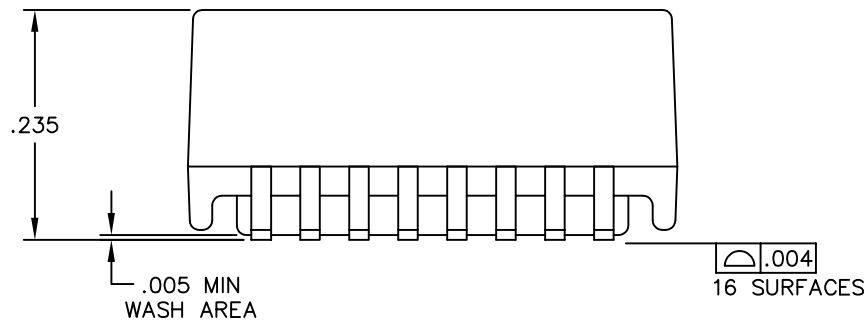
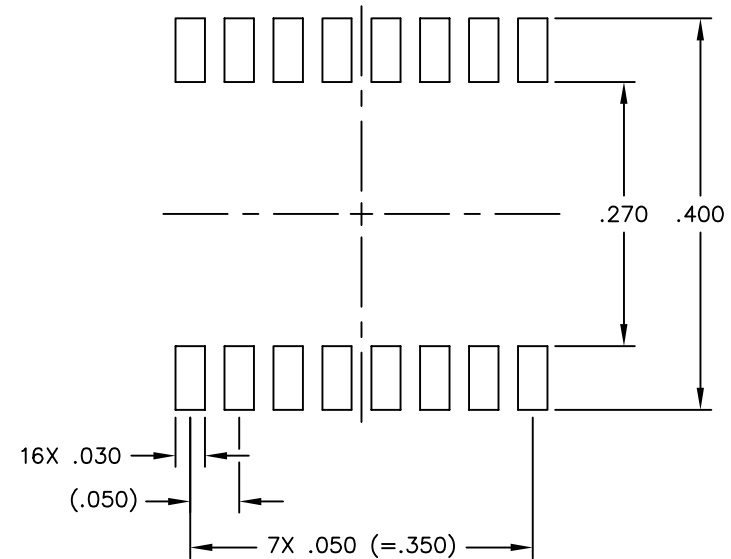
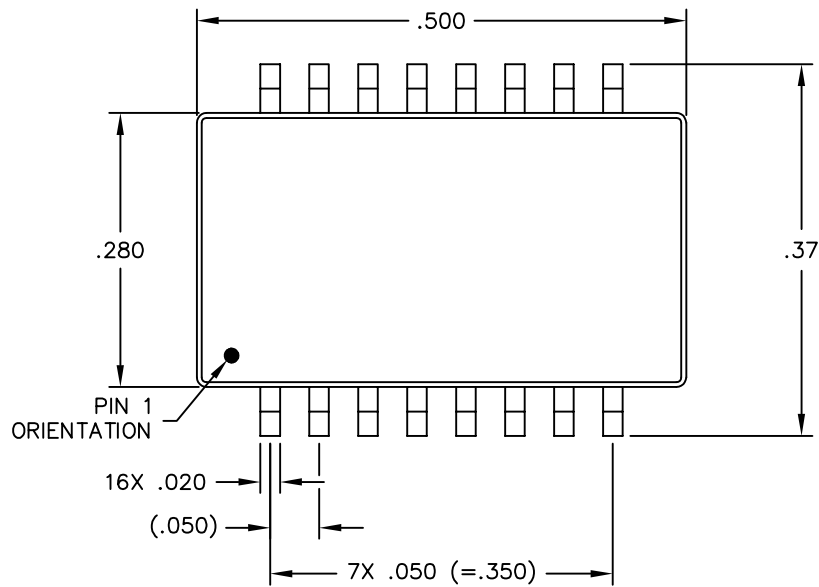

DIMENSIONS ARE IN INCHES WITH THE FOLLOWING TOLERANCES:

.XX= ±.01
.XXX= ±.005

© Copyright, 2016. Pulse Electronics Corp. All rights reserved. Pulse confidential & proprietary. (09/14/16)

PRODUCT DESCRIPTION	TLA DRAWING	PS DRAWING	SHEET	PART NO.	DATASHEET REV.
MDL,SIN,100D,1:1/1.5:1,SM,TU	HM1225NL-10	PS-2005.001-F	3 OF 3	HM1225NL	C

单击下面可查看定价，库存，交付和生命周期等信息

[>>Pulse\(普思\)](#)