

NOTES:

1. ROHS COMPLIANT
2. STORAGE TEMPERATURE: -50°C TO +125°C
3. COMPLIANCE TO J-STD:
  - A. J-STD-002: SOLDERABILITY AT 245°C REFLOW PROFILE
  - B. J-STD-020: LEVEL 1, NO MOISTURE SENSITIVE
  - C. J-STD-075: R7, 245°C MAXIMUM THROUGH REFLOW SOLDER
4. TO ORDER TAPE & REEL PACKAGING ADD A "T" SUFFIX TO THE PART NUMBER(i.e HX1112QNL BECOMES HX1112QNL T).

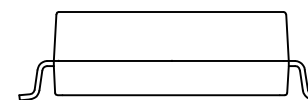
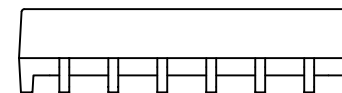
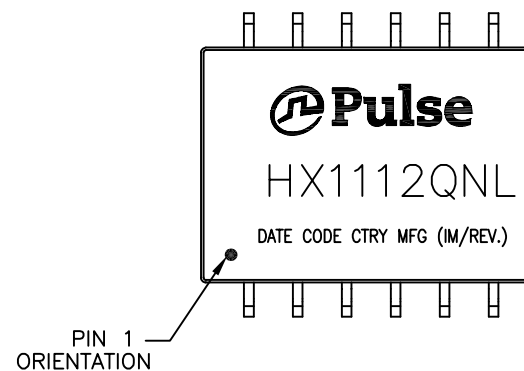

FINAL OUTLINE

© Copyright, 2015. Pulse Electronics Corp. All rights reserved. Pulse confidential & proprietary. (12/09/15)

PRODUCT DESCRIPTION	TLA DRAWING	PS DRAWING	SHEET	PART NO.	DATASHEET REV.
MDL,SIN,100D,1:1,SM,TU	HX1112QNL-P1	PS-0023.002-A	1 OF 3	HX1112QNL	A

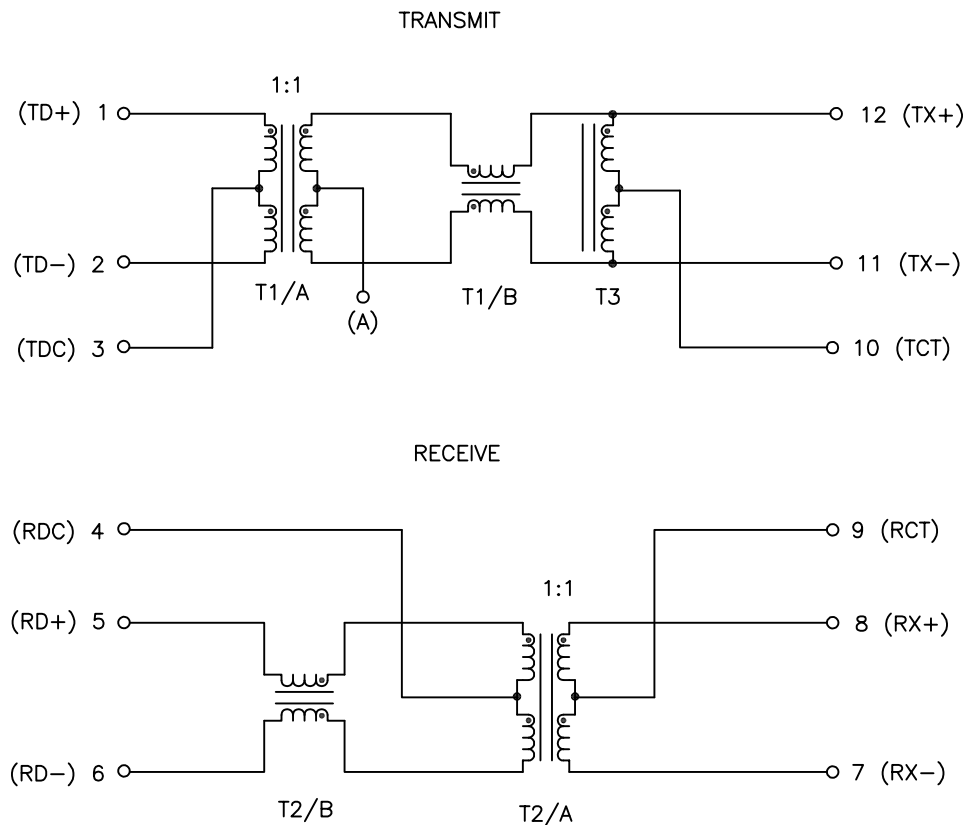

SCHEMATIC

ELECTRICAL CHARACTERISTICS AT +25°C UNLESS OTHER SPECIFIED  
(FOR REFERENCE ONLY. USED FOR CUSTOMER INFORMATION.)

PARAMETER	SPECIFICATIONS		
OPERATION TEMP	-40°C ~ +85°C		
TURNS RATIO	1 : 1 ±2%		
POLARITY	PER SCHEMATIC		
INSERTION LOSS	100 KHz	1-100 MHz	125 MHz
	-1.2 dB MAX	-1.0 dB MAX	-3.0 dB MAX
RETURN LOSS (Z OUT = 100 OHM ±15%)	.1-40 MHz		40-100 MHz
	-16 dB MIN		-10+20*LOG <sub>10</sub> (f/80 MHz) dB MIN
	-18 dB MIN (100 OHMs)		
INDUCTANCE (OCL) (MEDIA SIDE, -40°C-85°C)	350 uH MIN (MEASURED AT 100 KHz, 100 mVRMS) (AND WITH 8 mA DC BIAS)		
CROSSTALK, ADJACENT CHANNELS	1 MHz	10-100 MHz	
	-50 dB MIN	-33+20*LOG <sub>10</sub> (f/50) dB MIN	
COMMON MODE REJECTION RATIO	0.1-100 MHz		
	-30 dB MIN		
DC RESISTANCE, 1/2 WINDING	.65 OHMS MAX		
DC RESISTANCE IMBALANCE	±.065 OHMS MAX (CENTER TAP SYMMETRY)		
INPUT - OUTPUT ISOLATION	1500 VRMS MIN @ 60 SECONDS		

NOTE: f IS FREQUENCY IN MHz.

© Copyright, 2015. Pulse Electronics Corp. All rights reserved. Pulse confidential & proprietary. (12/09/15)

PRODUCT DESCRIPTION	TLA DRAWING	PS DRAWING	SHEET	PART NO.	DATASHEET REV.
MDL,SIN,100D,1:1,SM,TU	HX1112QNL-P1	PS-0023.002-A	2 OF 3	HX1112QNL	A

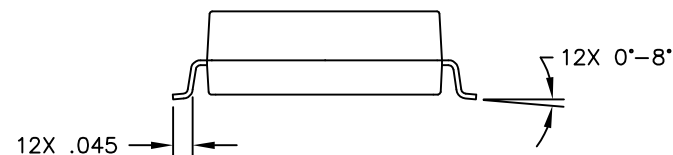
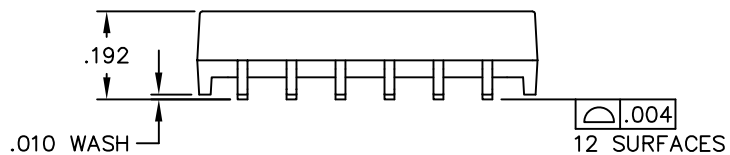
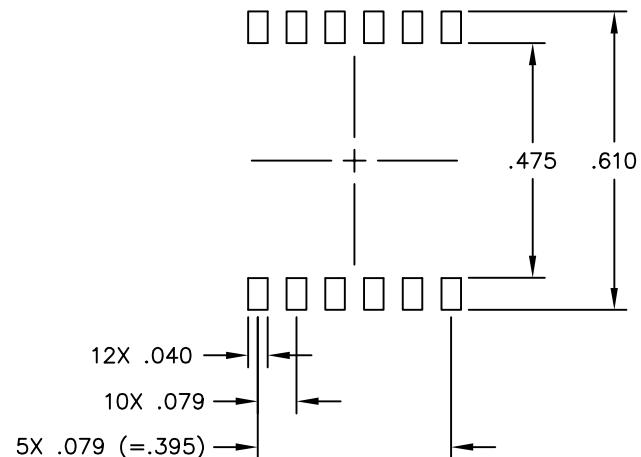
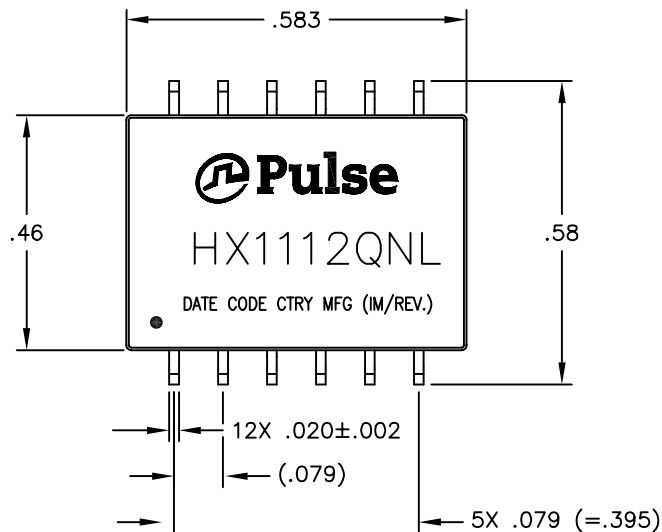

DIMENSIONS ARE IN INCHES WITH THE FOLLOWING  
TOLERANCES:  
.XX= ±.01  
.XXX= ±.005

© Copyright, 2015. Pulse Electronics Corp. All rights reserved. Pulse confidential & proprietary. (12/09/15)

PRODUCT DESCRIPTION	TLA DRAWING	PS DRAWING	SHEET	PART NO.	DATASHEET REV.
MDL,SIN,100D,1:1,SM,TU	HX1112QNL-P1	PS-0023.002-A	3 OF 3	HX1112QNL	A

单击下面可查看定价，库存，交付和生命周期等信息

[>>Pulse\(普思\)](#)