





Internal Antenna

5G/4G 2x2 MIMO FPC Antenna

W6114xxxx – 617 to 7125 MHz



Applications:

-  5G FR1/4G
-  Includes Band 71 (617-698MHz)
-  Foldable for tight spaces
-  Security, Video, Graphics
Transportation, Tracking
IoT Devices

Electrical specifications @ 25° C – Operating Temperatures – 40°C to +80°C

Frequency Bands – 617-960/1427-2690/3300-4200/4400-5000/5150-5925/6000-7125 MHz

Antenna type ²	Nominal Impedance	Polarization	Radiation pattern	Power withstanding
Dipole	50Ω	Linear	Omni	3W

Port	Frequency (MHz)	617-960	1427-2690	3300-4200	4400-5000	5150-5925	6000-7125
Port 1	Return Loss (dB)	< -5	< -6	< -5	< -6	< -5	< -4
	Peak Gain (dBi)	< 1.5	< 3.8	< 4.6	< 5.8	< 5	< 4.8
	Avg. Efficiency (%)	50	60	54	50	43	38
Port 2	Return Loss (dB)	< -6	< -6	< -5	< -6	< -5	< -4
	Peak Gain (dBi)	< 1.1	< 4.7	< 4.8	< 5.4	< 4	< 4.2
	Avg. Efficiency (%)	52	62	54	53	45	36
Isolation (dB)		< -10	< -12	< -18	< -25	< -25	< -32

Mechanical Specifications

Orderable PN: W6114B0100

Dimension	Color	Antenna Material	Connector Type ^{3,5}	Cable Type
Length x Width x Thickness	Black	FPC + adhesive	Equivalent of I-PEX MHF	1.13mm
Cable Length ^{4,5}	Weight	RoHS-6 Compliant		
100mm	2gram	Yes		

Notes:

1. Storage Temperature: -40°C to 80°C
2. FPC antenna is measured on the 2mm ABS/PC plate.
3. Default Connector: Equivalent of I-PEX MHF or compatible with U.FL connector.
4. Cable length is a distance between the edge of PCB and the center of connector.
5. Contact sales for custom cable lengths and connector type.

Mechanical Drawing

W6114xxxx

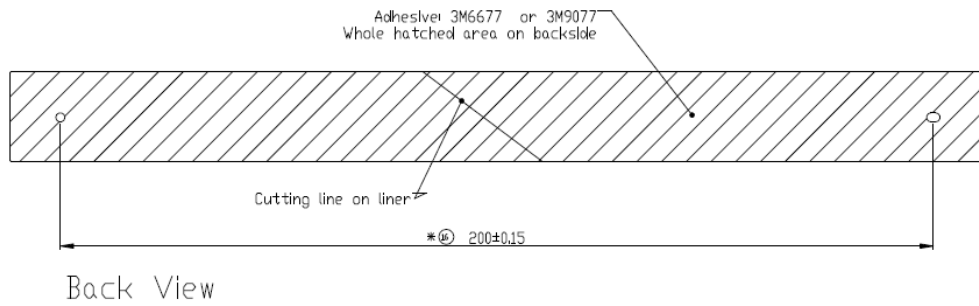
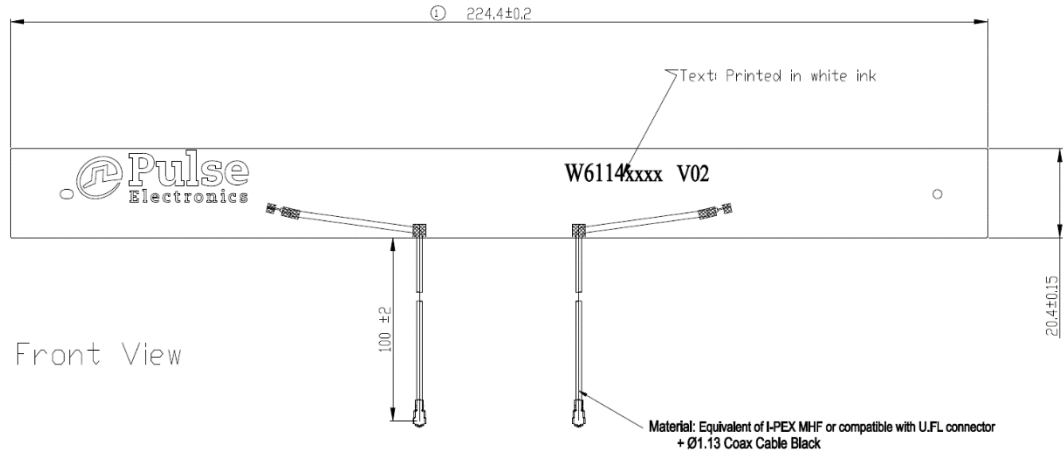

Dimensions: mm
Unless otherwise specified, all tolerances are ±0.25mm

Testing Setup

W6114xxxx

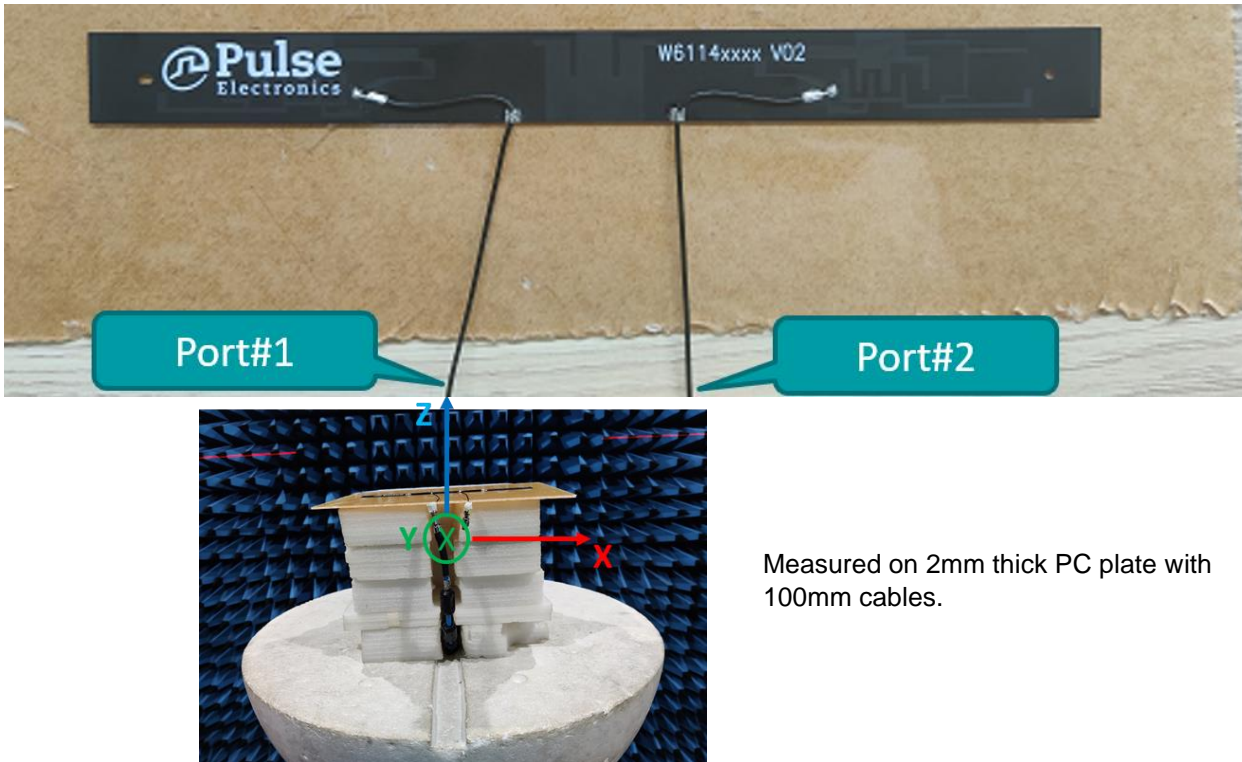

Charts- Return Loss

W6114xxxx

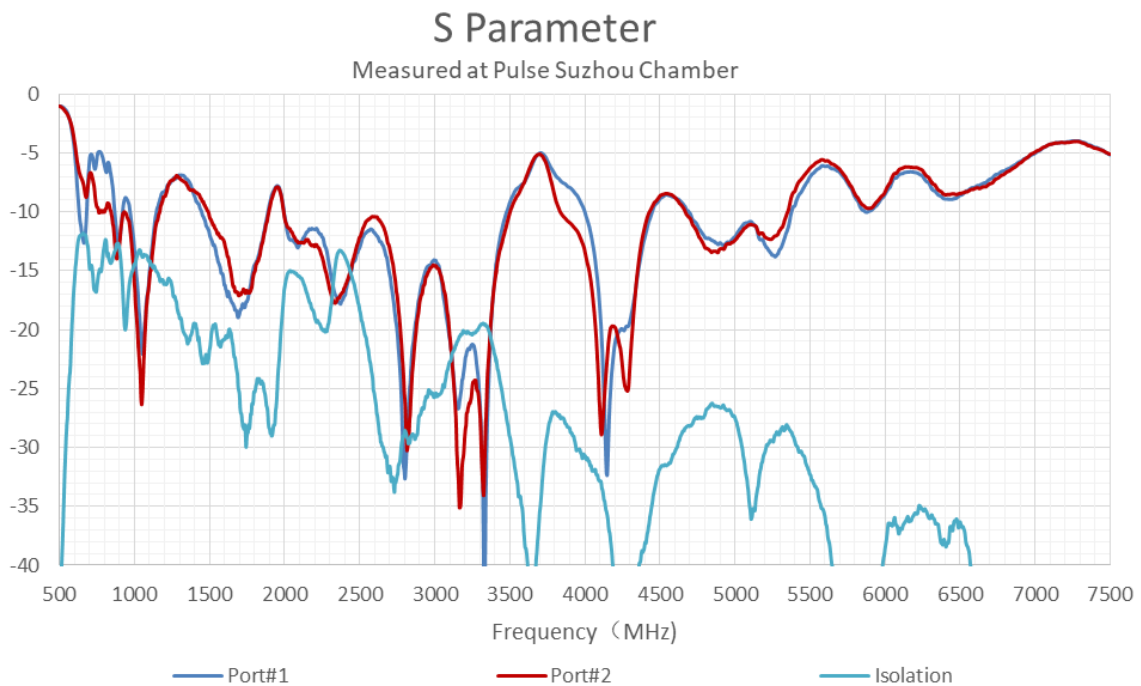

Charts- Peak Gain and Efficiency

W6114xxxx

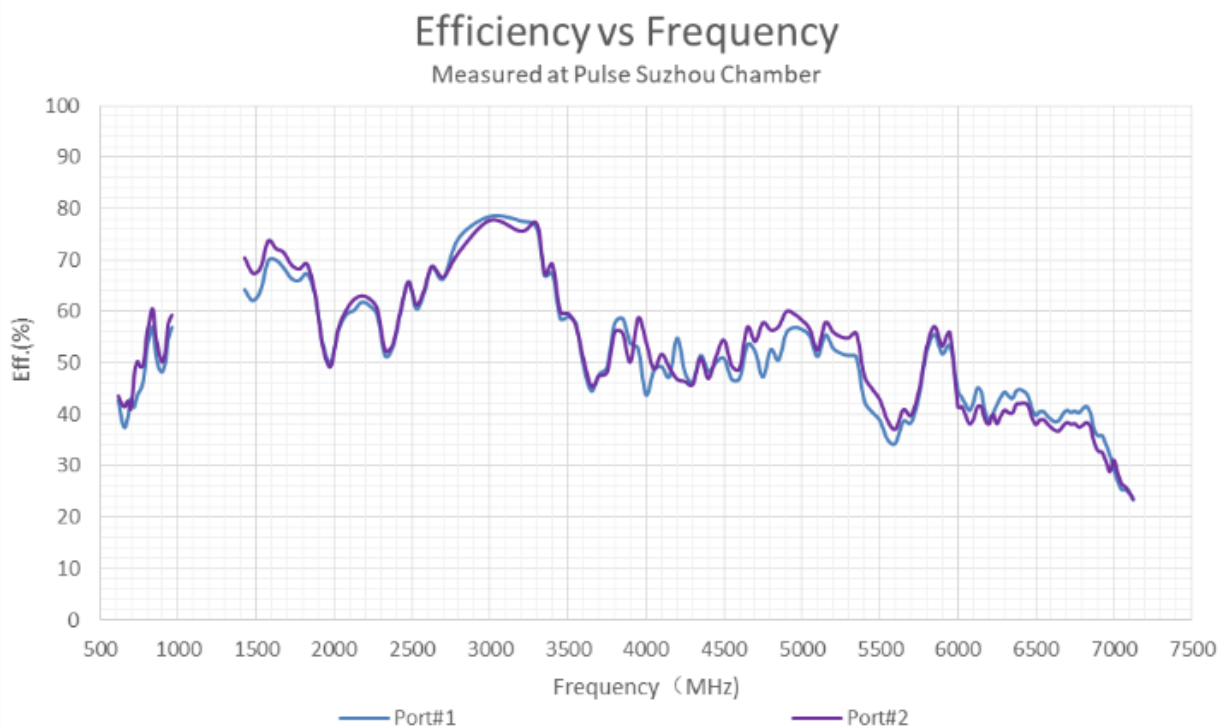
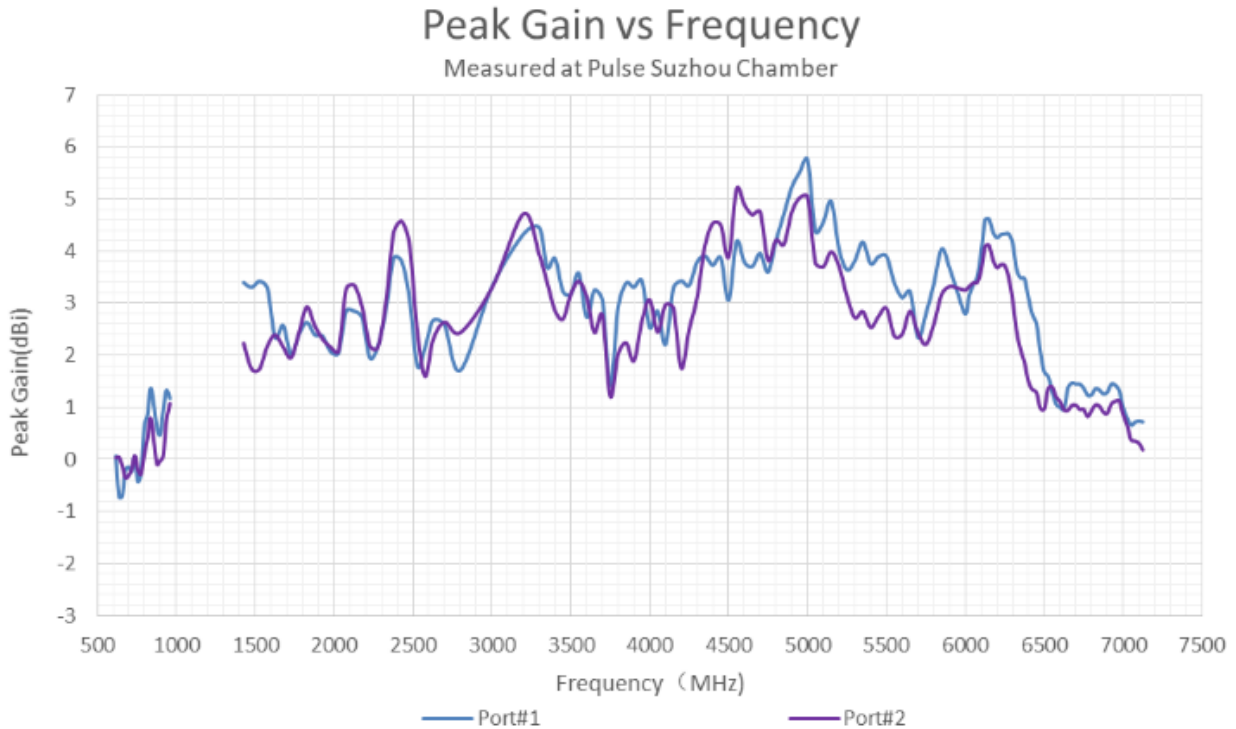

Charts- XY Gain Plots, Port 1

W6114, Port 1

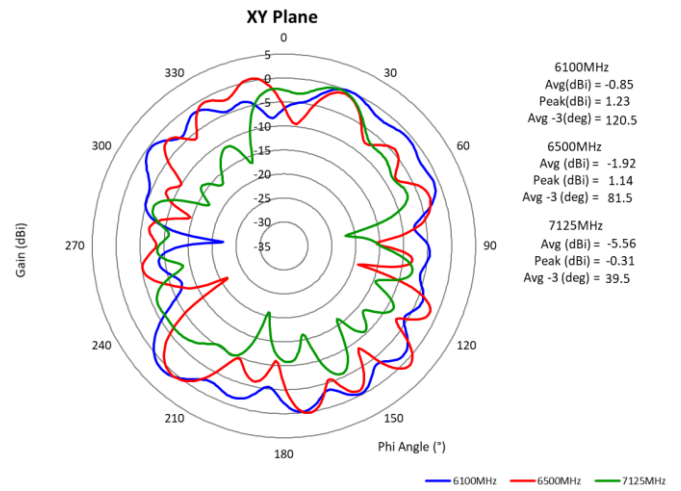
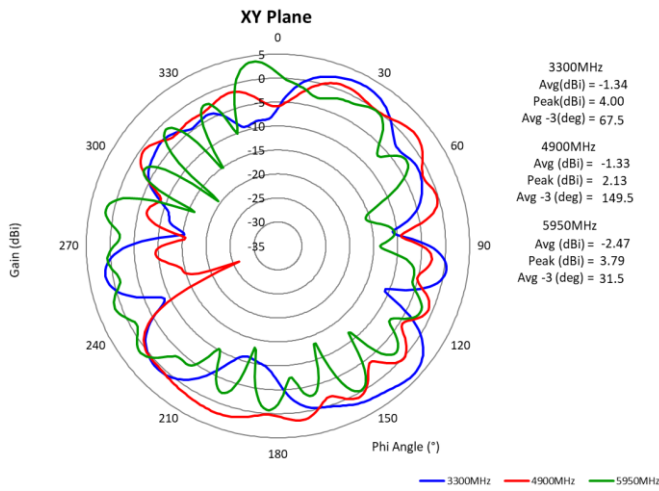
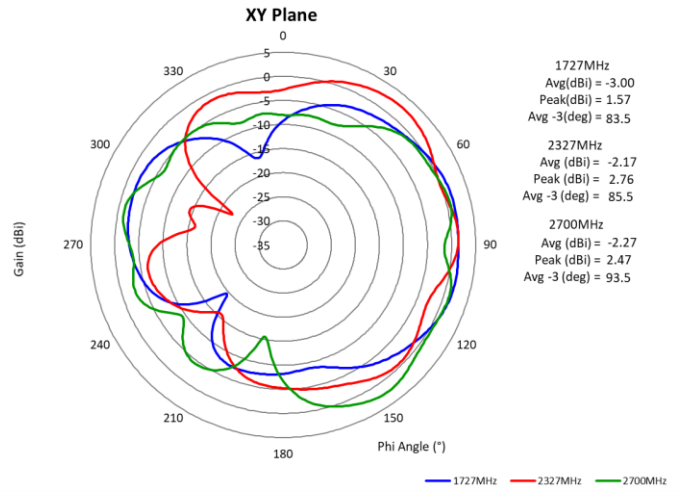
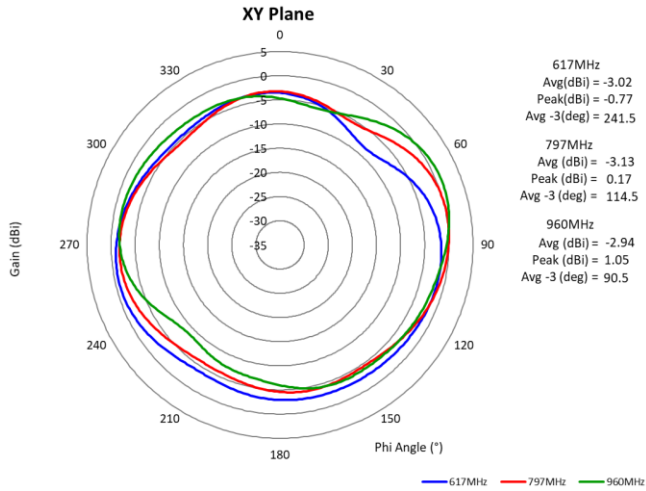

Charts – YZ Gain Plots, Port 1

W6114, Port 1

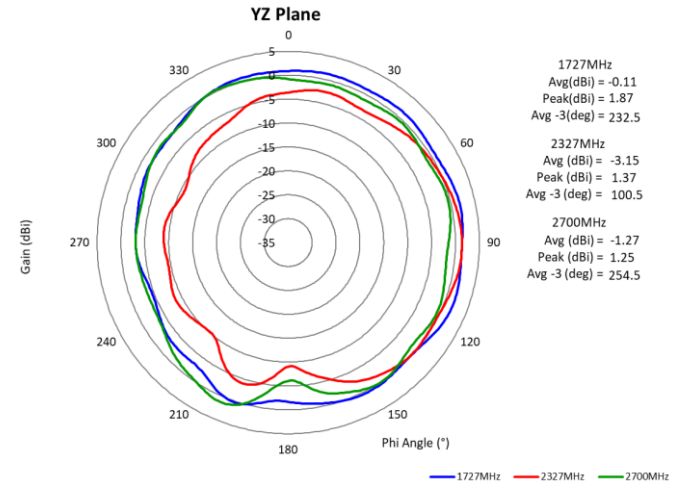
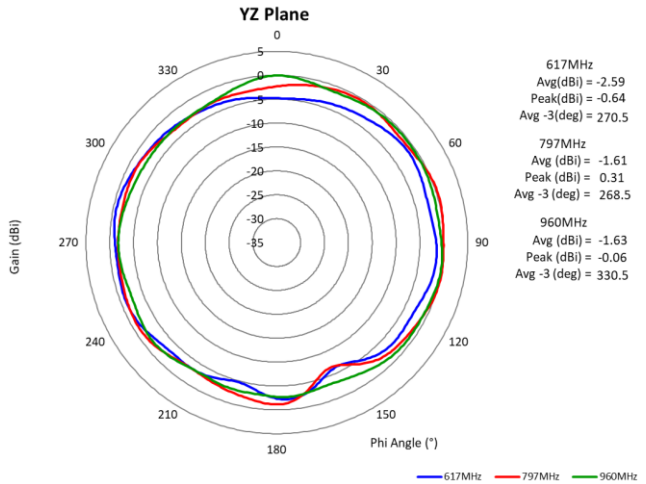

Charts – YZ Gain Plots, Port 1 (Cont.)

W6114, Port 1

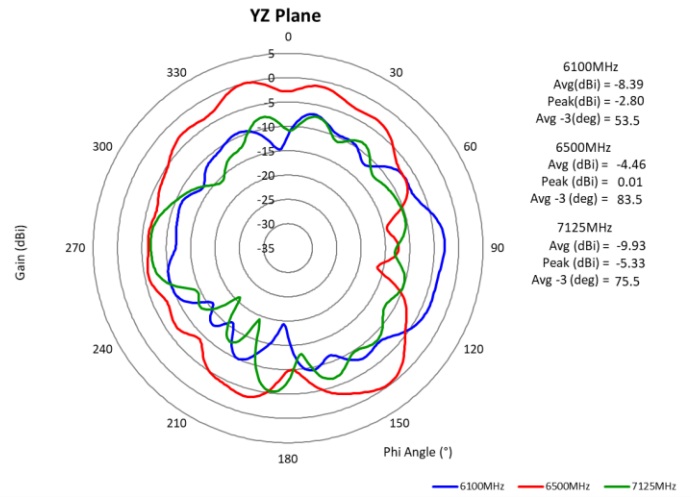
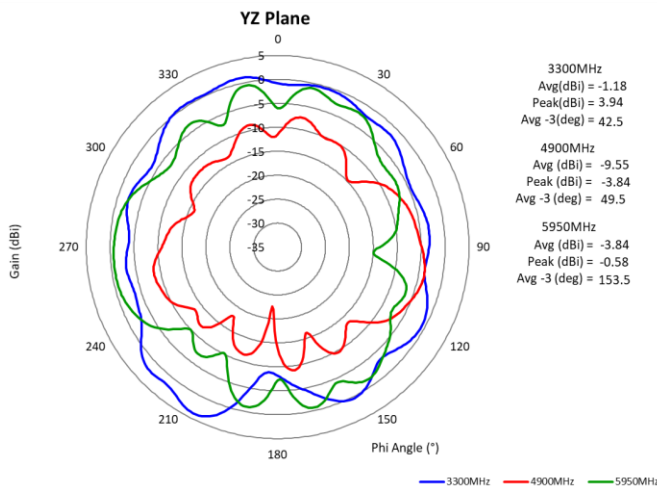

Charts – ZX Gain Plots, Port 1

W6114, Port 1

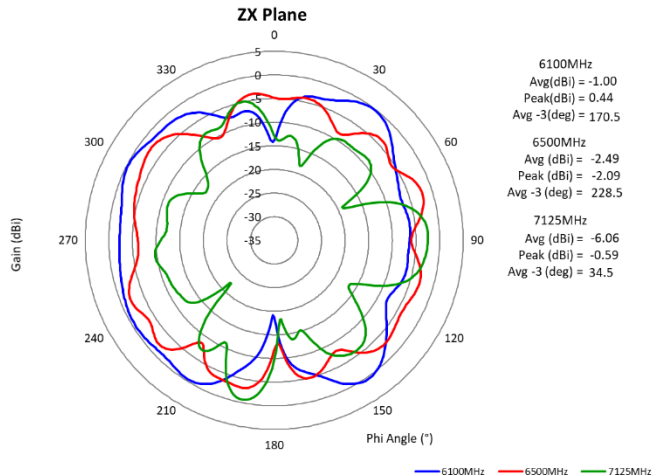
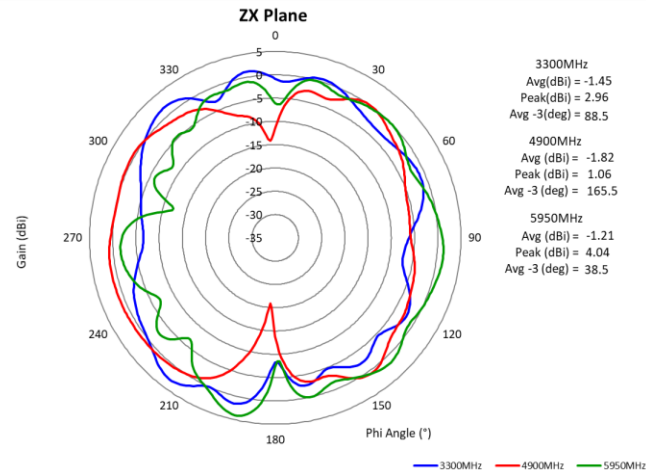
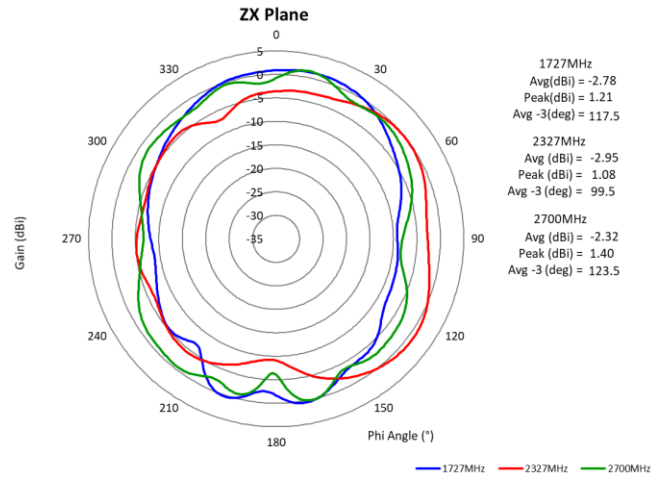
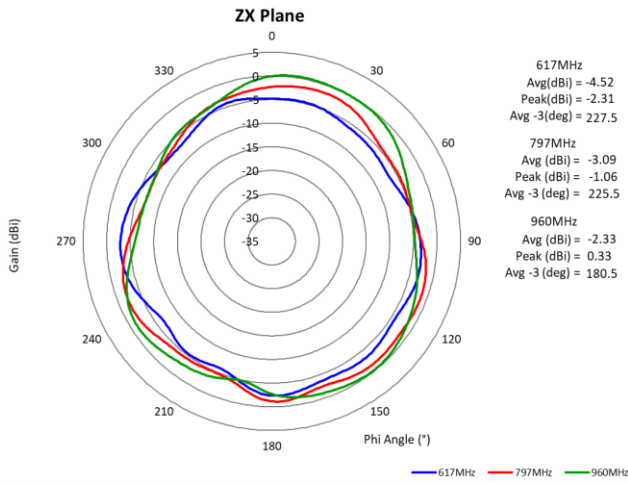

Charts- XY Gain Plots, Port 2

W6114, Port 2

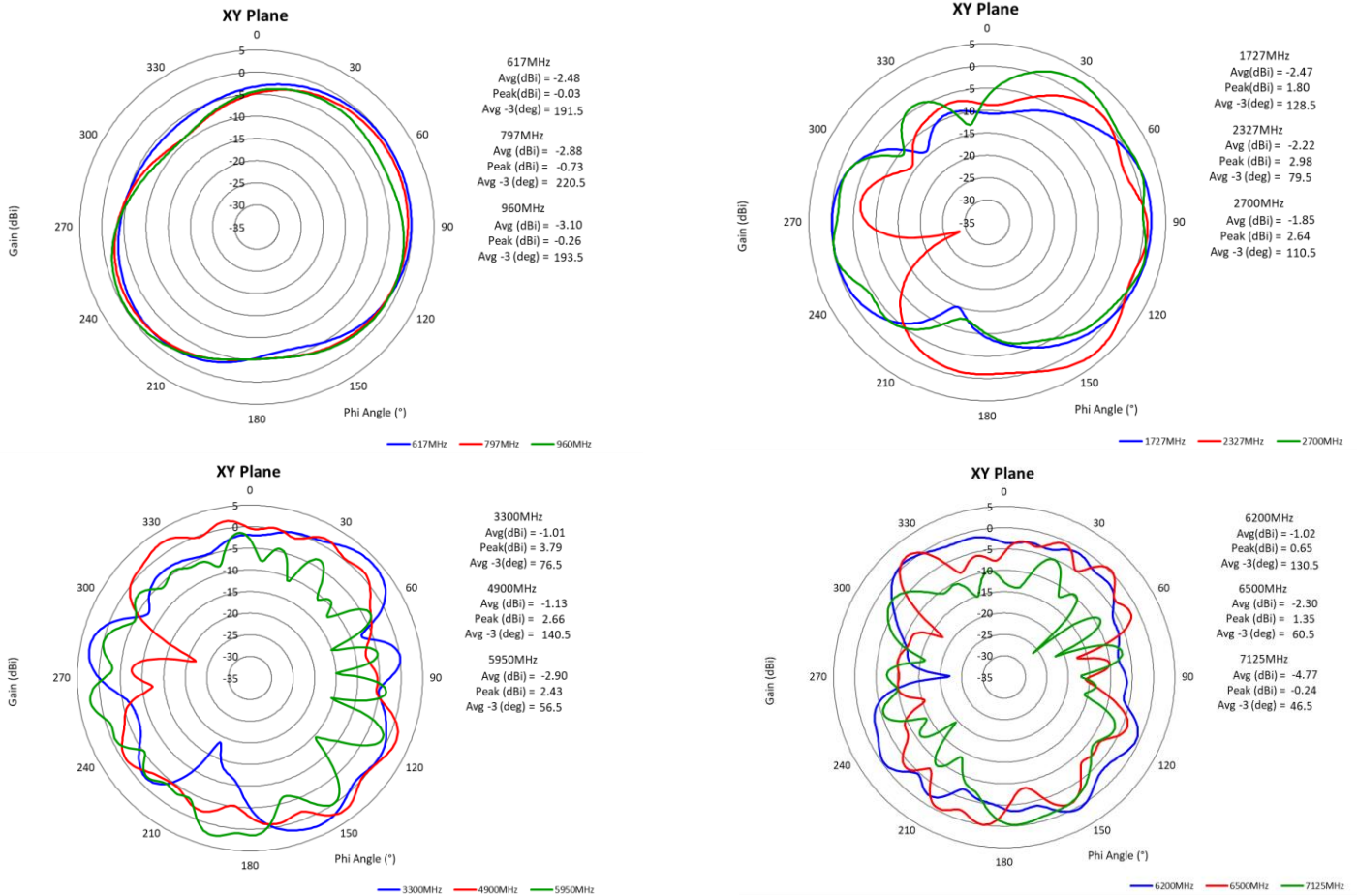

Charts – YZ Gain Plots, Port 2

W6114, Port 2

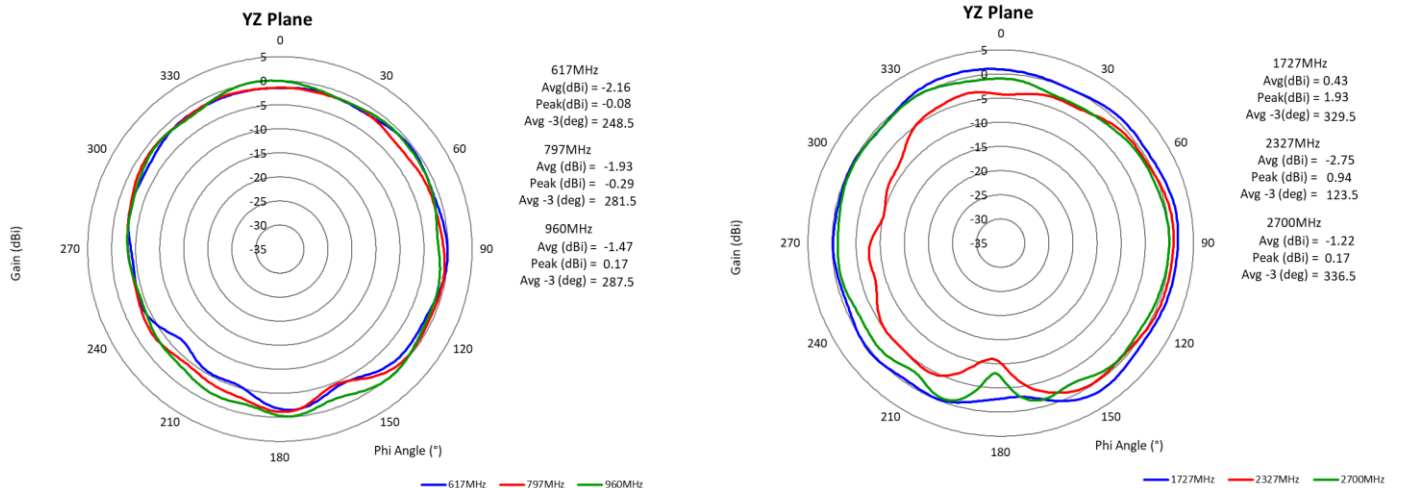

Charts – YZ Gain Plots, Port 2 (Cont.)

W6114, Port 2

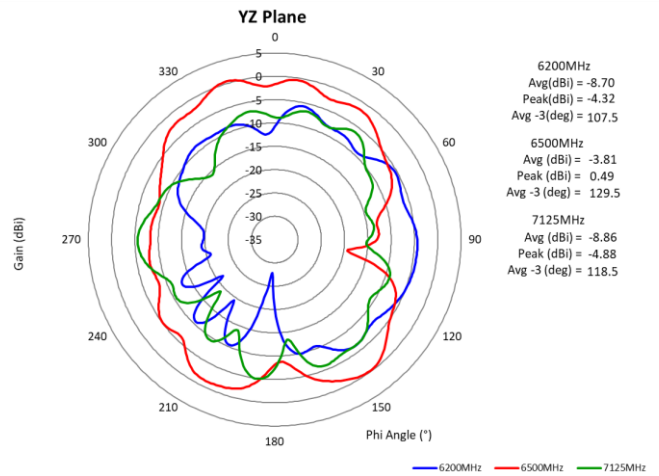
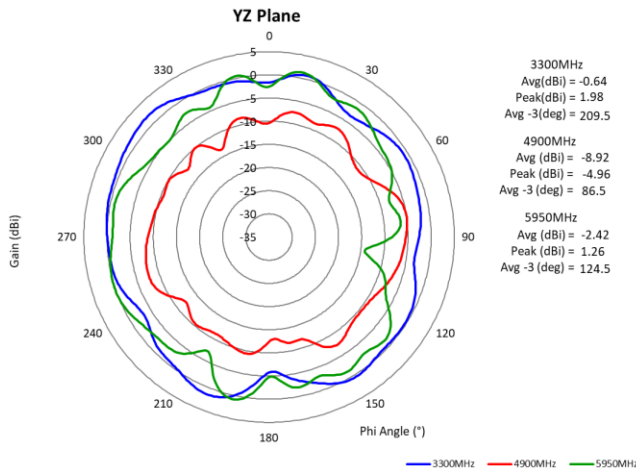

Charts – ZX Gain Plots, Port 2

W6114, Port 2

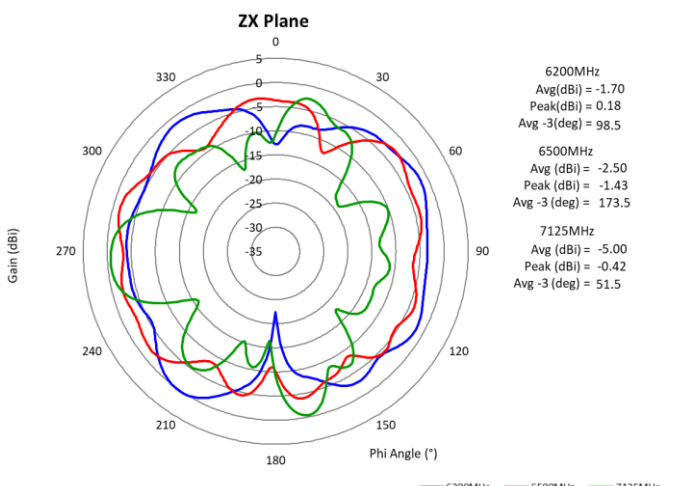
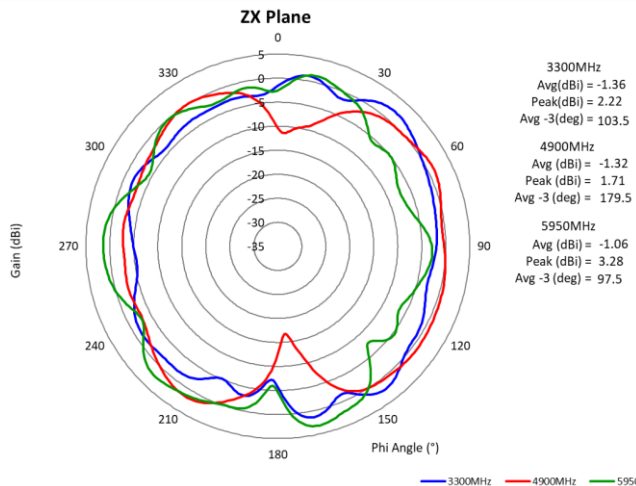
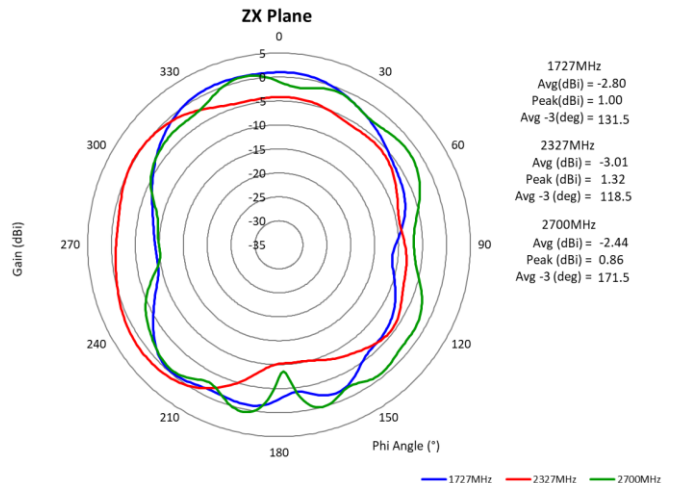
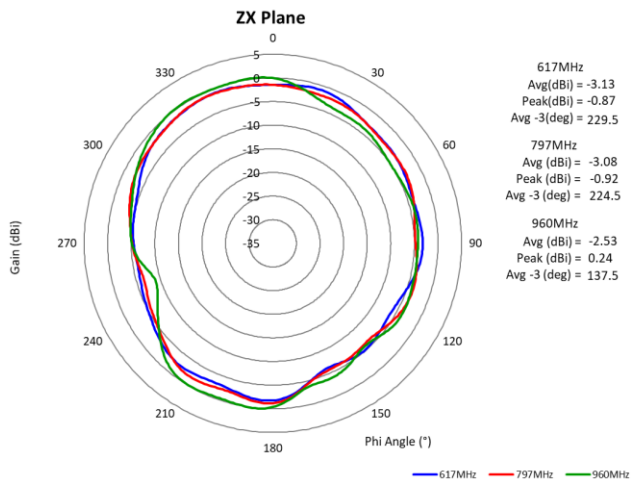

Package

W6114xxxx

Packaging info:

10 antennas put into a PE bag, every 10 PE bag into a bubble bag and sealing it.
12 bubble bags into 1 out box.
Total 1200pcs antenna in 1 out box.

Additional Product Info

Family Products – 5G FR1 FPC

5G / 4G FPC Antennas

Orderable PN	Frequency (MHz)	Connector Type	Cable Length	Cable Type
W3435B0100	617-960/1710-6000	Equivalent of I-PEX MHF	100mm	1.13mm (AWG#32)
W3929B0100	617-960/1710-3900	Equivalent of I-PEX MHF	100mm	1.13mm (AWG#32)

For More Information:

Americas - antennas.us@pulseelectronics.com | Europe – antennas.eu@pulseelectronics.com | Asia – antennas.as@pulseelectronics.com | Questions? +1-800-ANTENNA
Performance warranty of products offered on this data sheet is limited to the parameters specified. Data is subject to change without notice. Other brand and product names mentioned herein may be trademarks or registered trademarks of their respective owners. © Copyright , 2020. Pulse Electronics, Inc. All rights reserved.

单击下面可查看定价，库存，交付和生命周期等信息

[>>Pulse\(普思\)](#)