

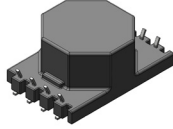





Isolation Power Transformers

Toroid Platform SMD



-  Push Pull Converter Transformer
-  4.4kVrms Isolation (1500Vrms Continuous)
-  Reinforced Insulation: IEC62368-1/UL62368-1 Certified
-  22mm Creepage Distance
-  Footprint: 29.1 x 20x12.5 mm max

Electrical Specifications @ 25°C - Operating Temperature -40°C to +85°C

Part Number	Inductance (1-3) (uH Min)	Leakage Inductance (uH MAX)	DCR (1-2) (3-4) (mohm MAX)	DCR (5-6) (7-8) (mohm MAX)	E*T(1-4) ¹ (V*uSec Max)	Turns Ratio (1-4):(8-5) ±3.0%	Hi-Pot Voltage (Vrms)
PGT6541NLT	25	0.6	100	200	34	1:1.78	4400

Notes:

1. The E*T rating limits the peak flux density to 2100 gauss (flux swing 4200 gauss). When used in bipolar drive applications.
2. The applied ET may need to be further derated for higher frequencies based on the temperature rise which results from the core and copper losses
 - A. To calculate total copper loss (W), use the following formula:
Copper Loss (W)=I_{rms_Primary}²*DCR_Primary+I_{rms_Secondary}²*DCR_Secondary
 - B. To calculate total core loss (W), use the following formula:
Core Loss (W)= (3.66E-10) * (Frequency in KHz)^{1.78} * (55*(ET/ET Max)^{2.53}
Where ET is the applied Volt Second, ET Max is the rated Volt Second for 55mT flux swing, Frequency 410KHz
3. C. To calculate temperature rise, use the following formula: Temperature Rise (°C)
=140*(Core Loss(W)+Copper Loss (W))
4. For Push-Pull topology, where the voltage is applied across half the primary winding turns, the ET needs to be derated by 50% for the same flux swing.
5. 22mm package creepage distance satisfies IEC62368-1 & IEC61558-1/-2-16 reinforced insulation requirements for working voltage to 1500Vrms max, OVC II, Pollution Degree 2 and altitude up to 2000m.
6. Unless otherwise specified, all testing is made at 100kHz, 0.1VAC.

Isolation Power Transformers

Toroid Platform SMD

Mechanical

Schematic

PMT6709NLT

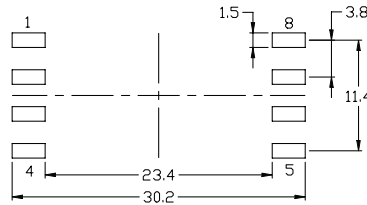
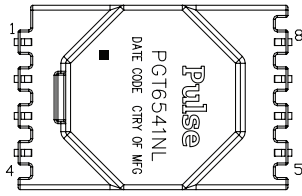

SUGGESTED LAND PATTERN

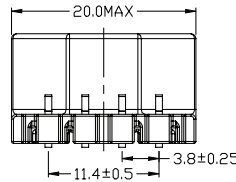
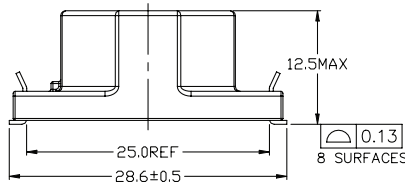

PUSH-PULL

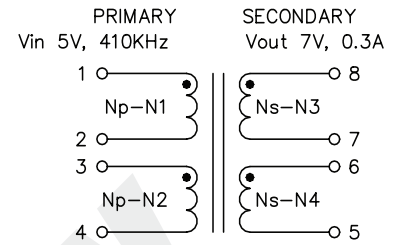

SCHEMATIC (PUSH-PULL)

Weight1.6grams

Dimensions: mm
Unless otherwise specified,
all tolerances are ± 0.25

TAPE & REEL INFO

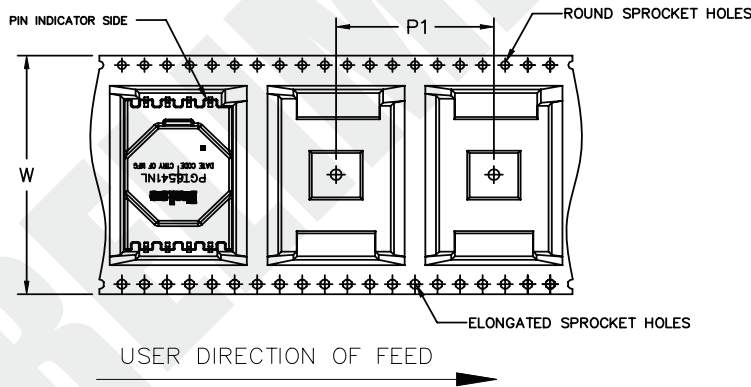

SURFACE MOUNTING TYPE, REEL/TAPE LIST

PART NUMBER	REEL SIZE (mm)	TAPE SIZE (mm)			QTY
	A	P ₁	W	K ₀	PCS/REEL
PGT6541NLT	Ø330	28	44	12.7	150

For More Information:

Americas - prodinfo_power_americas@yageo.com | Europe - prodinfo_power_emea@yageo.com | Asia - prodinfo_power_asia@yageo.com

Performance warranty of products offered on this data sheet is limited to the parameters specified. Data is subject to change without notice. Other brand and product names mentioned herein may be trademarks or registered trademarks of their respective owners. © Copyright, 2023. Pulse Electronics, Inc. All rights reserved.

YAGEO Corporation and its affiliates do not recommend the use of commercial or automotive grade products for high reliability applications or manned space flight.

Isolation Power Transformers

Toroid Platform SMD

APPLICATION

PGT6541NLT is one high isolation power supply transformer drivers. Intended to operate in a fixed duty cycle Push Pull topology, it is a part of a low cost solution for delivering lower power (up to 3W) from a low voltage source. A typical implementation would be an isolated RS-485/RS-232 power supply driver circuit, the design is compatible with the SN6505NL.

A schematic diagram for the Push Pull converter topology is given below.

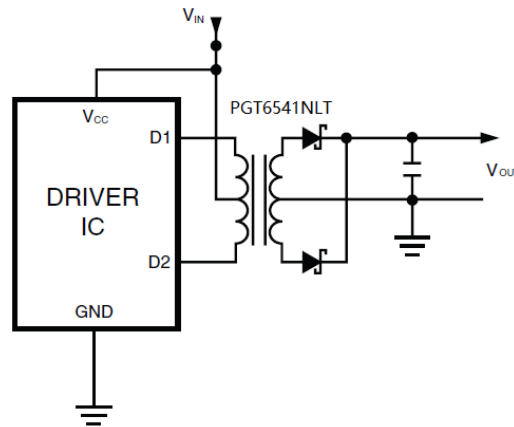

For a fixed 50% duty cycle mode of operation, the output voltage is simply determined by the input voltage and turns ratio. So, with the available turn ratios, a variety of output voltages can be met.

This transformer design has been certified by UL to comply with IEC62368-1:2018 with reinforced insulation for a working voltage up to 1500Vdc 22mm creepage and 4400VAC isolation voltage is guaranteed to meet this requirement. The design also complies with the Pulse's class F insulation system.

For More Information:

Americas - proinfo_power_americas@yageo.com | Europe - proinfo_power_emea@yageo.com | Asia - proinfo_power_asia@yageo.com

Performance warranty of products offered on this data sheet is limited to the parameters specified. Data is subject to change without notice. Other brand and product names mentioned herein may be trademarks or registered trademarks of their respective owners. © Copyright, 2023. Pulse Electronics, Inc. All rights reserved.

YAGEO Corporation and its affiliates do not recommend the use of commercial or automotive grade products for high reliability applications or manned space flight.

单击下面可查看定价，库存，交付和生命周期等信息

[>>Pulse\(普思\)](#)