

Series: Satellite Navigation System

Description: Antenna GPS/GLONASS/
Beidou/Galileo

PART NUMBER: W3010



Features:

- Omni directional radiation
- Low profile
- Compact size W x L x H (3.2 x 10.0 x 2.0 mm)
- Low weight (310 mg)
- Fully SMD compatible
- Lead free soldering compatible
- Tape and reel packaging
- RoHS Compliant Product
- MSL-1

Applications:

- Systems:
GPS/GLONASS/Beidou/Galileo
- 1560 – 1610 MHz
- Global Navigation
- Asset and Fleet Tracking
- Mobile Devices
- Industrial, Internet of Things

All dimensions are in mm / inches

Issue: 2035

In the effort to improve our products, we reserve the right to make changes judged to be necessary.

CONFIDENTIAL AND PROPRIETARY INFORMATION

This document contains confidential and proprietary information of Pulse Electronics, Inc. (Pulse) and is protected by copyright, trade secret and other state and federal laws. Its receipt or possession does not convey any rights to reproduce, disclose its contents, or to manufacture, use or sell anything it may describe. Reproduction, disclosure or use without specific written authorization of Pulse is strictly forbidden.

For more information:

Pulse Worldwide Headquarters
15255 Innovation Drive #100
San Diego, CA 92128
USA
Tel: 1-858-674-8100

Pulse/Larsen Antennas
18110 SE 34th St Bldg 2 Suite 250
Vancouver, WA 98683
USA
Tel: 1-360-944-7551

Europe Headquarters
Pulse GmbH & Do, KG
Zeppelinstrasse 15
Herrenberg, Germany

Pulse (Suzhou) Wireless Products Co, Inc.
99 Huo Ju Road(#29 Bldg,4th Phase
Suzhou New District
Jiangsu Province, Suzhou 215009 PR China
Tel: 86 512 6807 9998

Series: Satellite Navigation System

Description: Antenna GPS/GLONASS/
Beidou/Galileo

PART NUMBER: W3010

ELECTRICAL SPECIFICATIONS

Antenna Type	Ceramic
Frequency	1560-1610 MHz
Nominal Impedance	50 Ω
Return Loss	<-12 dB
VSWR min	1.6:1
Efficiency	-1.2 dB
Efficiency	75%
Gain Max	3dBi ± 1 dBi
Gain Max RHCP	1dBic ± 1 dBic
Power withstanding	2 watts
Connector type	SMD

MECHANICAL SPECIFICATIONS

Size	3.2 x 10 x 2 mm
Weight	0.31 g
MSL (Moisture Sensitivity Level)	1

ENVIRONMENTAL SPECIFICATIONS

Operating Temperature	-40/+85 ° C
Storage Temperature	-10/+30 ° C
RoHS Compliant	Yes

Issue: 2035

In the effort to improve our products, we reserve the right to make changes judged to be necessary.

CONFIDENTIAL AND PROPRIETARY INFORMATION

This document contains confidential and proprietary information of Pulse Electronics, Inc. (Pulse) and is protected by copyright, trade secret and other state and federal laws. Its receipt or possession does not convey any rights to reproduce, disclose its contents, or to manufacture, use or sell anything it may describe. Reproduction, disclosure or use without specific written authorization of Pulse is strictly forbidden.

Series: Satellite Navigation System

Description: Antenna GPS/GLONASS/
Beidou/Galileo

PART NUMBER: W3010

MECHANICAL DRAWING

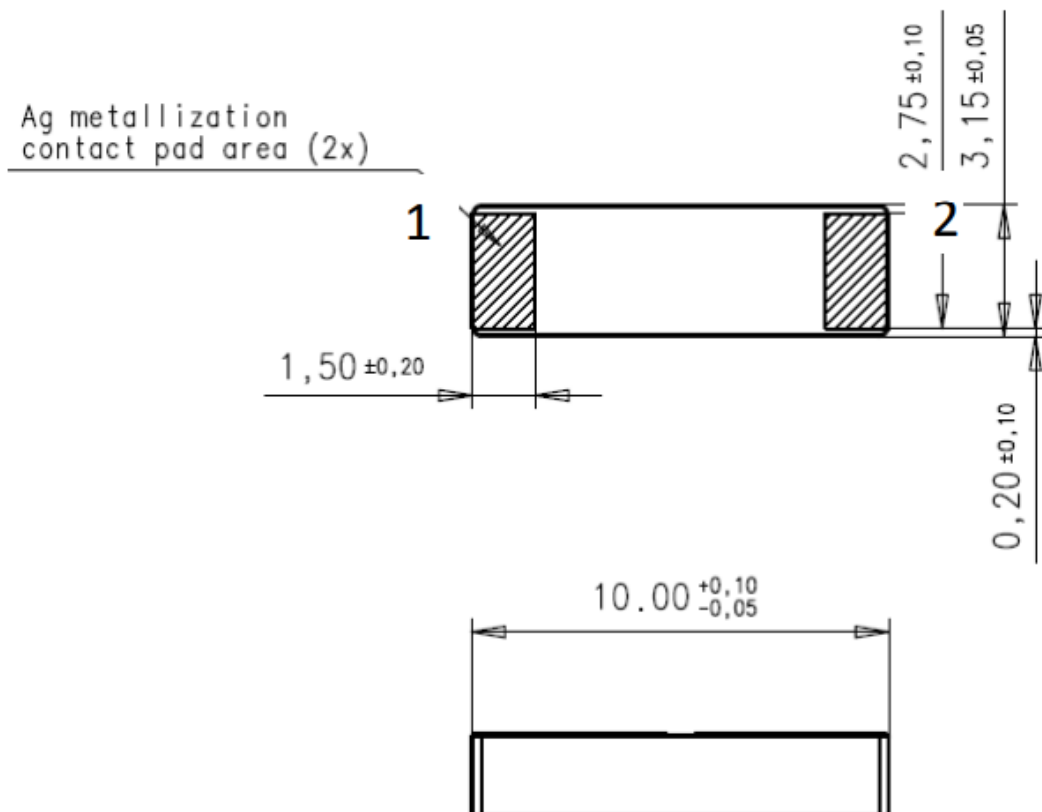

No.	Terminal Name	Terminal Dimensions
1	Feed / GND	1.50 x 2.75 mm
2	Feed / GND	1.50 x 2.75 mm
Antenna is symmetrical. Either of terminals 1 or 2 can be Feed / GND		

Issue: 2035

In the effort to improve our products, we reserve the right to make changes judged to be necessary.

CONFIDENTIAL AND PROPRIETARY INFORMATION

This document contains confidential and proprietary information of Pulse Electronics, Inc. (Pulse) and is protected by copyright, trade secret and other state and federal laws. Its receipt or possession does not convey any rights to reproduce, disclose its contents, or to manufacture, use or sell anything it may describe. Reproduction, disclosure or use without specific written authorization of Pulse is strictly forbidden.

Series: Satellite Navigation System

Description: Antenna GPS/GLONASS/
Beidou/Galileo

PART NUMBER: W3010

OTHER SPECIFICATIONS

Terminal Configuration

Layout

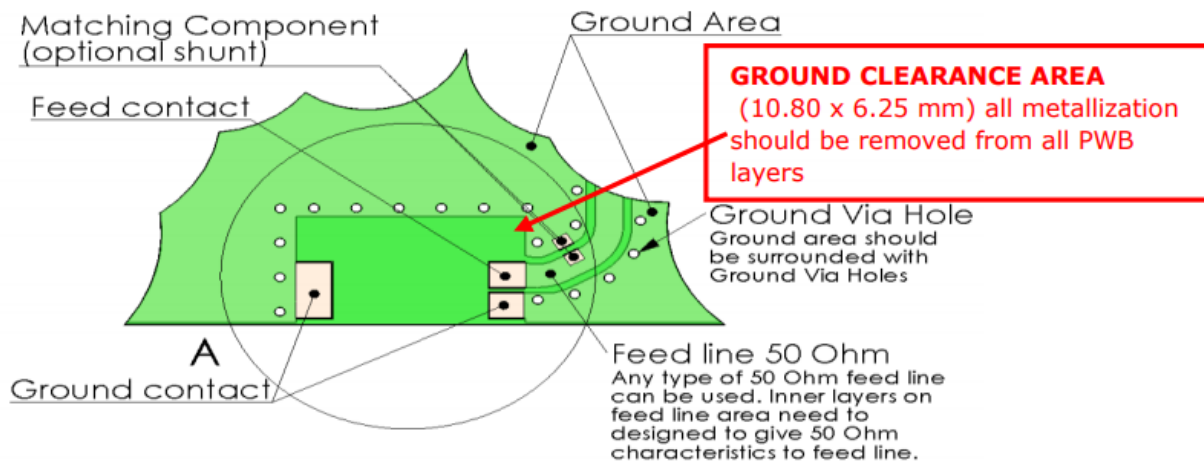

Pad dimensions on PWB layout

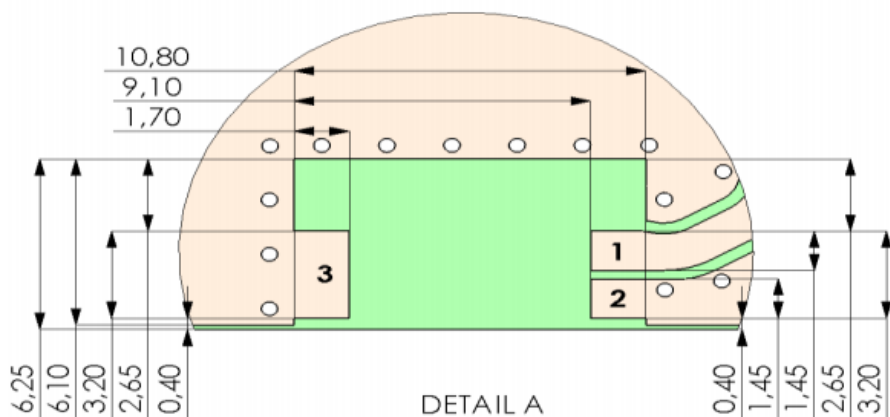

PWB Features		
No.	Terminal Name	Terminal Dimensions
1	Feed	1.7 x 1.45 mm
2	GND	1.7 x 1.45 mm
3	GND	1.7 x 3.20 mm

Issue: 2035

In the effort to improve our products, we reserve the right to make changes judged to be necessary.

CONFIDENTIAL AND PROPRIETARY INFORMATION

This document contains confidential and proprietary information of Pulse Electronics, Inc. (Pulse) and is protected by copyright, trade secret and other state and federal laws. Its receipt or possession does not convey any rights to reproduce, disclose its contents, or to manufacture, use or sell anything it may describe. Reproduction, disclosure or use without specific written authorization of Pulse is strictly forbidden.

Series: Satellite Navigation System

Description: Antenna GPS/GLONASS/
Beidou/Galileo

PART NUMBER: W3010

CHARTS

Typical Electrical Characteristics (T=25 ° C)

Measured on the 80 x 37 mm test board without matching circuit

Typical Return Loss S11/ impedance

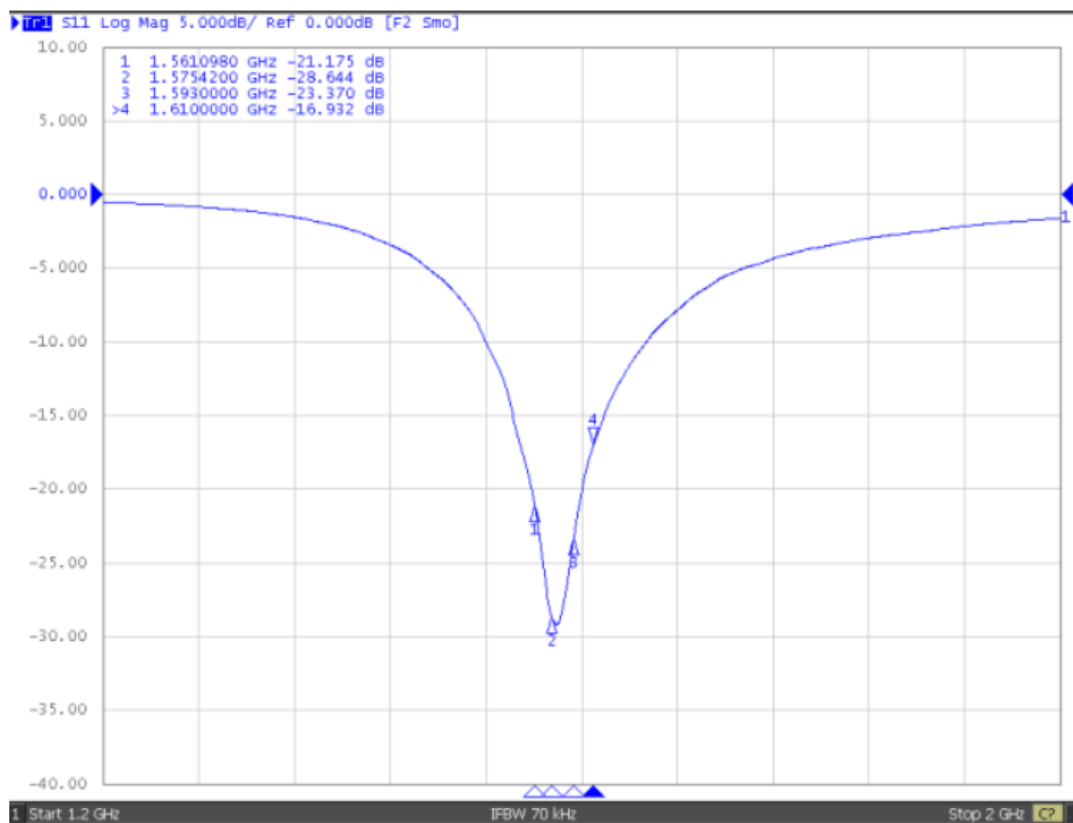

Issue: 2035

In the effort to improve our products, we reserve the right to make changes judged to be necessary.

CONFIDENTIAL AND PROPRIETARY INFORMATION

This document contains confidential and proprietary information of Pulse Electronics, Inc. (Pulse) and is protected by copyright, trade secret and other state and federal laws. Its receipt or possession does not convey any rights to reproduce, disclose its contents, or to manufacture, use or sell anything it may describe. Reproduction, disclosure or use without specific written authorization of Pulse is strictly forbidden.

Series: Satellite Navigation System

Description: Antenna GPS/GLONASS/
Beidou/Galileo

PART NUMBER: W3010

CHARTS

Free space efficiency and maximum gain

Total Efficiency

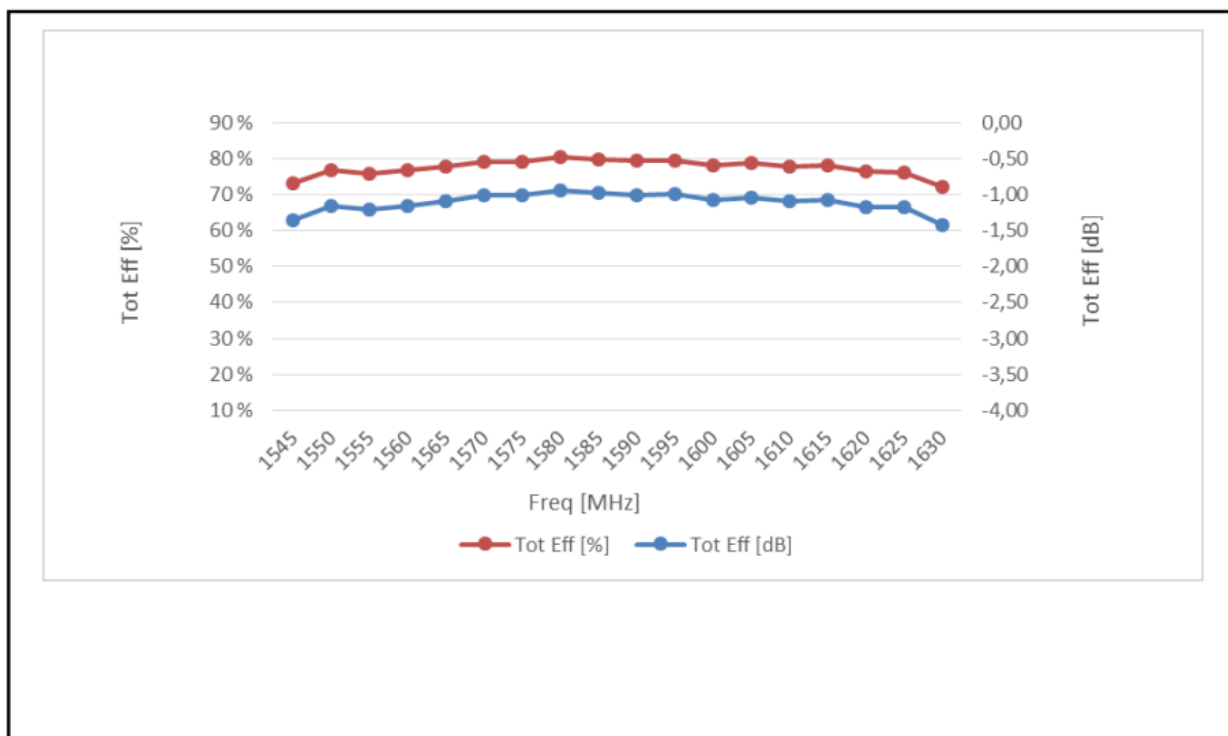

Issue: 2035

In the effort to improve our products, we reserve the right to make changes judged to be necessary.

CONFIDENTIAL AND PROPRIETARY INFORMATION

This document contains confidential and proprietary information of Pulse Electronics, Inc. (Pulse) and is protected by copyright, trade secret and other state and federal laws. Its receipt or possession does not convey any rights to reproduce, disclose its contents, or to manufacture, use or sell anything it may describe. Reproduction, disclosure or use without specific written authorization of Pulse is strictly forbidden.

Series: Satellite Navigation System

Description: Antenna GPS/GLONASS/
Beidou/Galileo

PART NUMBER: W3010

CHARTS

Gain

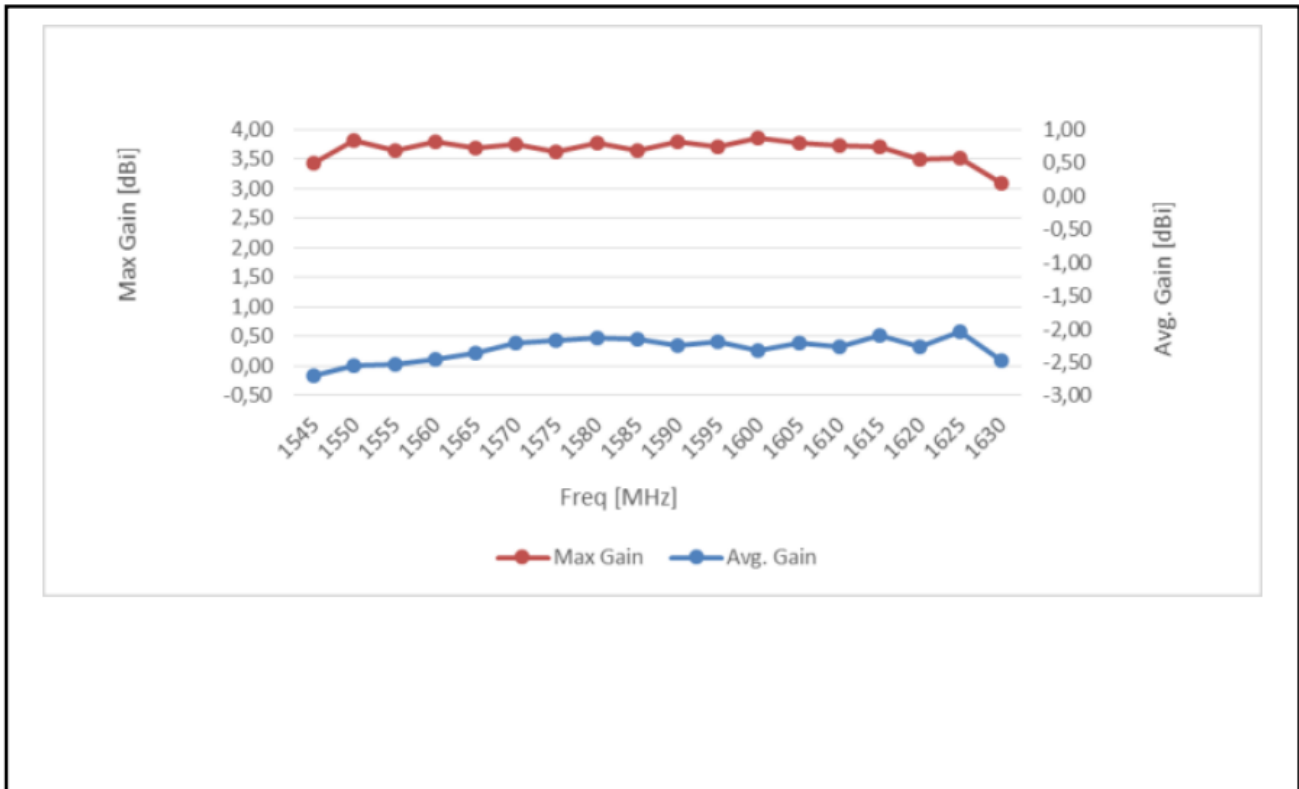

Issue: 2035

In the effort to improve our products, we reserve the right to make changes judged to be necessary.

CONFIDENTIAL AND PROPRIETARY INFORMATION

This document contains confidential and proprietary information of Pulse Electronics, Inc. (Pulse) and is protected by copyright, trade secret and other state and federal laws. Its receipt or possession does not convey any rights to reproduce, disclose its contents, or to manufacture, use or sell anything it may describe. Reproduction, disclosure or use without specific written authorization of Pulse is strictly forbidden.

Series: Satellite Navigation System

Description: Antenna GPS/GLONASS/
Beidou/Galileo

PART NUMBER: W3010

CHARTS

RHCP Gain

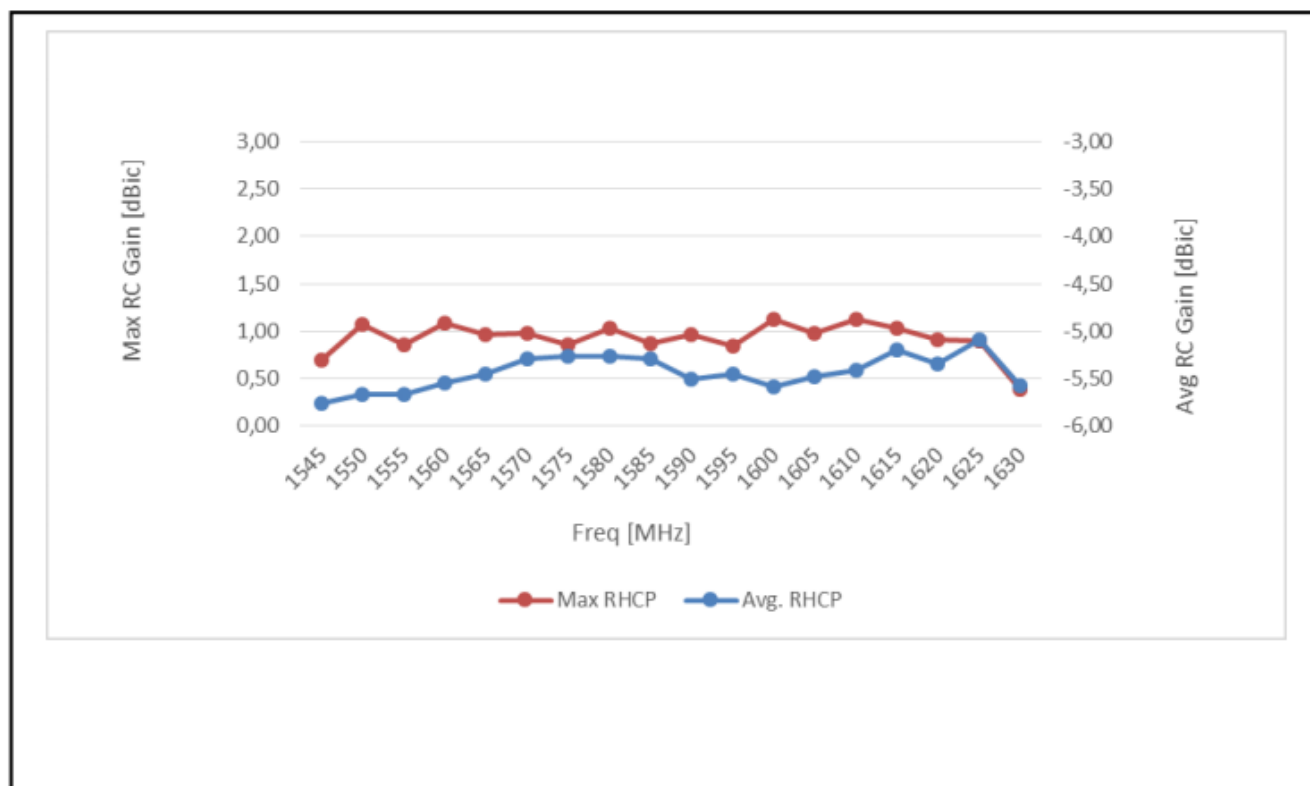

Issue: 2035

In the effort to improve our products, we reserve the right to make changes judged to be necessary.

CONFIDENTIAL AND PROPRIETARY INFORMATION

This document contains confidential and proprietary information of Pulse Electronics, Inc. (Pulse) and is protected by copyright, trade secret and other state and federal laws. Its receipt or possession does not convey any rights to reproduce, disclose its contents, or to manufacture, use or sell anything it may describe. Reproduction, disclosure or use without specific written authorization of Pulse is strictly forbidden.

Series: Satellite Navigation System

Description: Antenna GPS/GLONASS/
Beidou/Galileo

PART NUMBER: W3010

CHARTS

Typical Free space Radiation Patterns

Radiation pattern coordinates

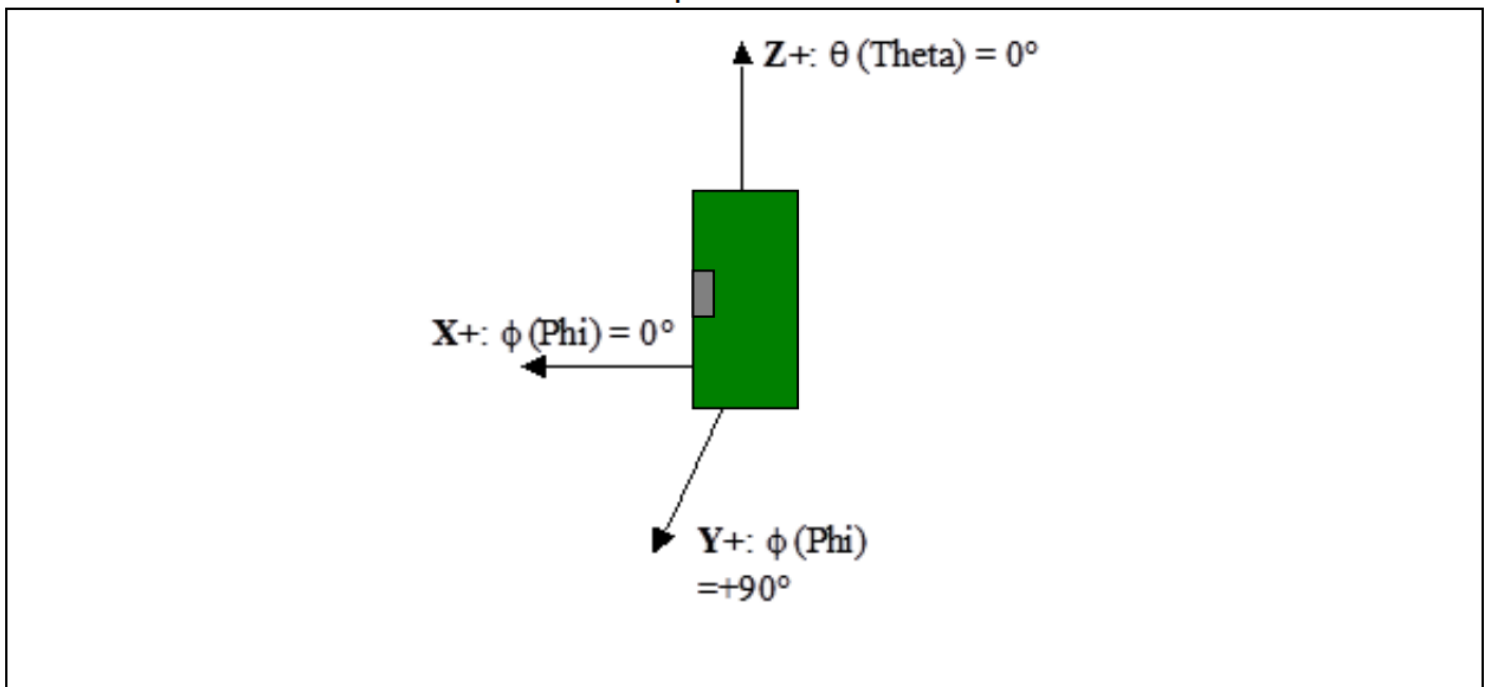

Series: Satellite Navigation System

Description: Antenna GPS/GLONASS/
Beidou/Galileo

PART NUMBER: W3010

CHARTS

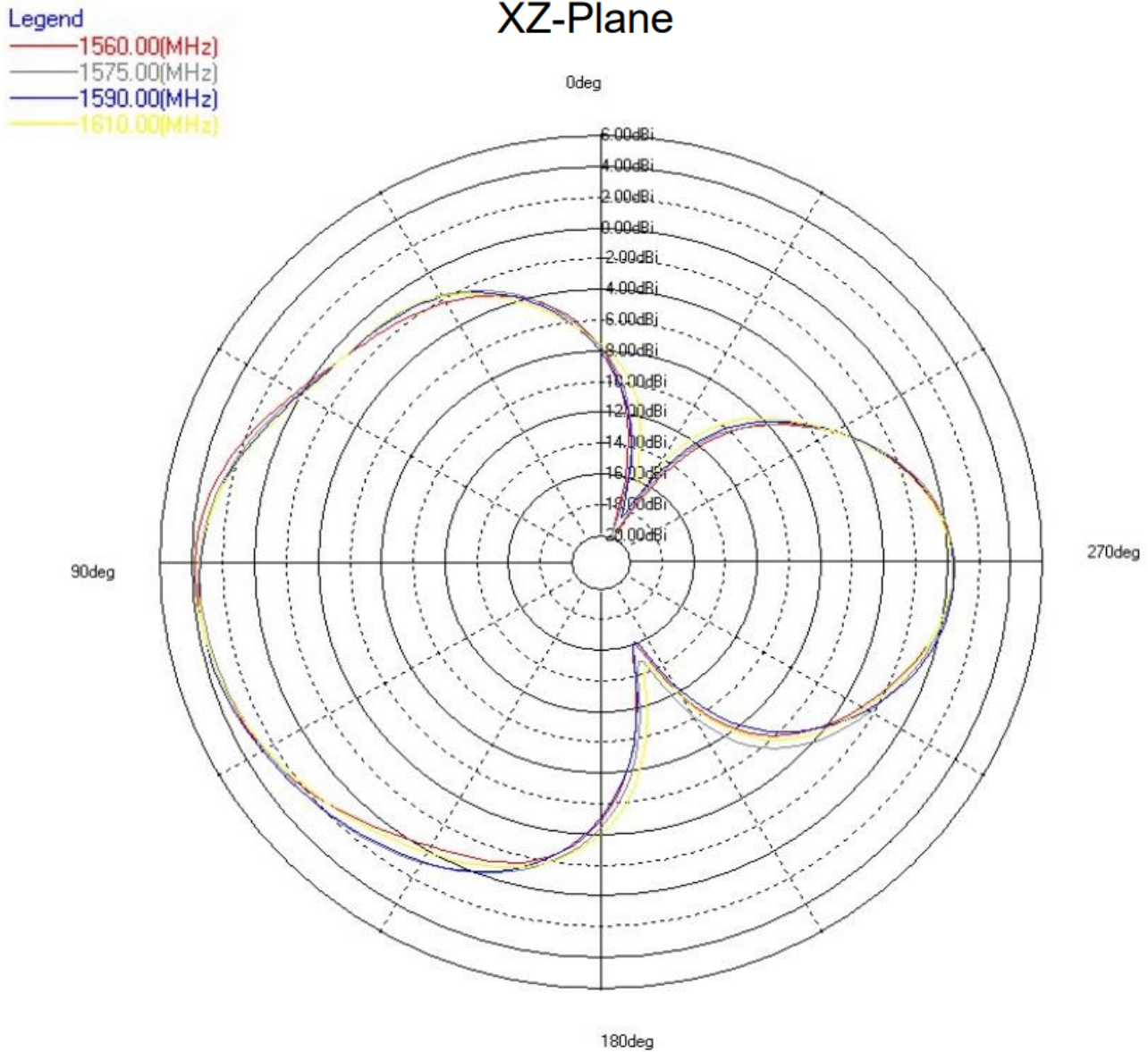

Issue: 2035

In the effort to improve our products, we reserve the right to make changes judged to be necessary.

CONFIDENTIAL AND PROPRIETARY INFORMATION

This document contains confidential and proprietary information of Pulse Electronics, Inc. (Pulse) and is protected by copyright, trade secret and other state and federal laws. Its receipt or possession does not convey any rights to reproduce, disclose its contents, or to manufacture, use or sell anything it may describe. Reproduction, disclosure or use without specific written authorization of Pulse is strictly forbidden.

Series: Satellite Navigation System

Description: Antenna GPS/GLONASS/
Beidou/Galileo

PART NUMBER: W3010

CHARTS

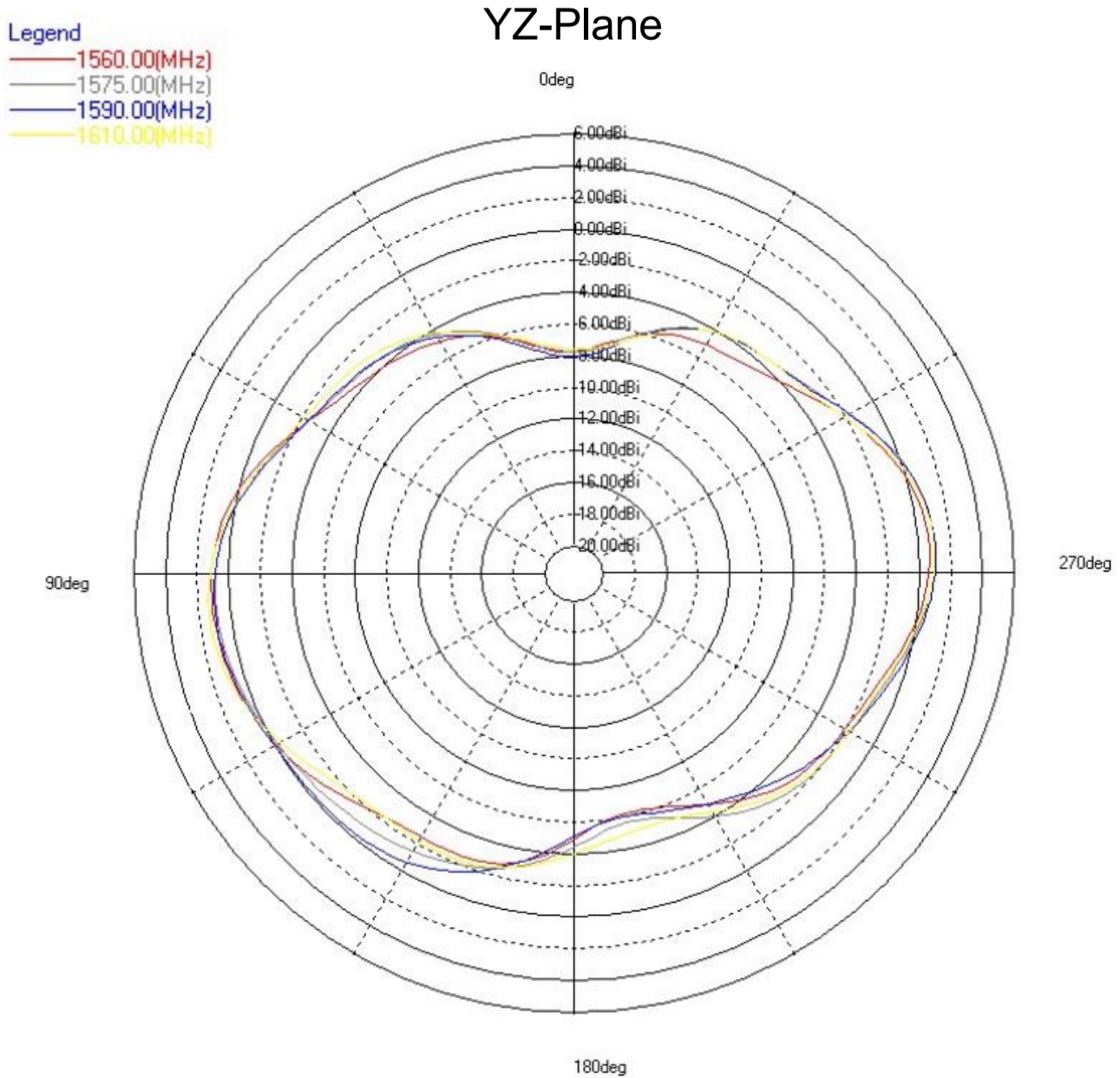

Issue: 2035

In the effort to improve our products, we reserve the right to make changes judged to be necessary.

CONFIDENTIAL AND PROPRIETARY INFORMATION

This document contains confidential and proprietary information of Pulse Electronics, Inc. (Pulse) and is protected by copyright, trade secret and other state and federal laws. Its receipt or possession does not convey any rights to reproduce, disclose its contents, or to manufacture, use or sell anything it may describe. Reproduction, disclosure or use without specific written authorization of Pulse is strictly forbidden.

Series: Satellite Navigation System

Description: Antenna GPS/GLONASS/
Beidou/Galileo

PART NUMBER: W3010

CHARTS

- Legend
- 1560.00(MHz)
 - 1575.00(MHz)
 - 1590.00(MHz)
 - 1610.00(MHz)

XY-Plane

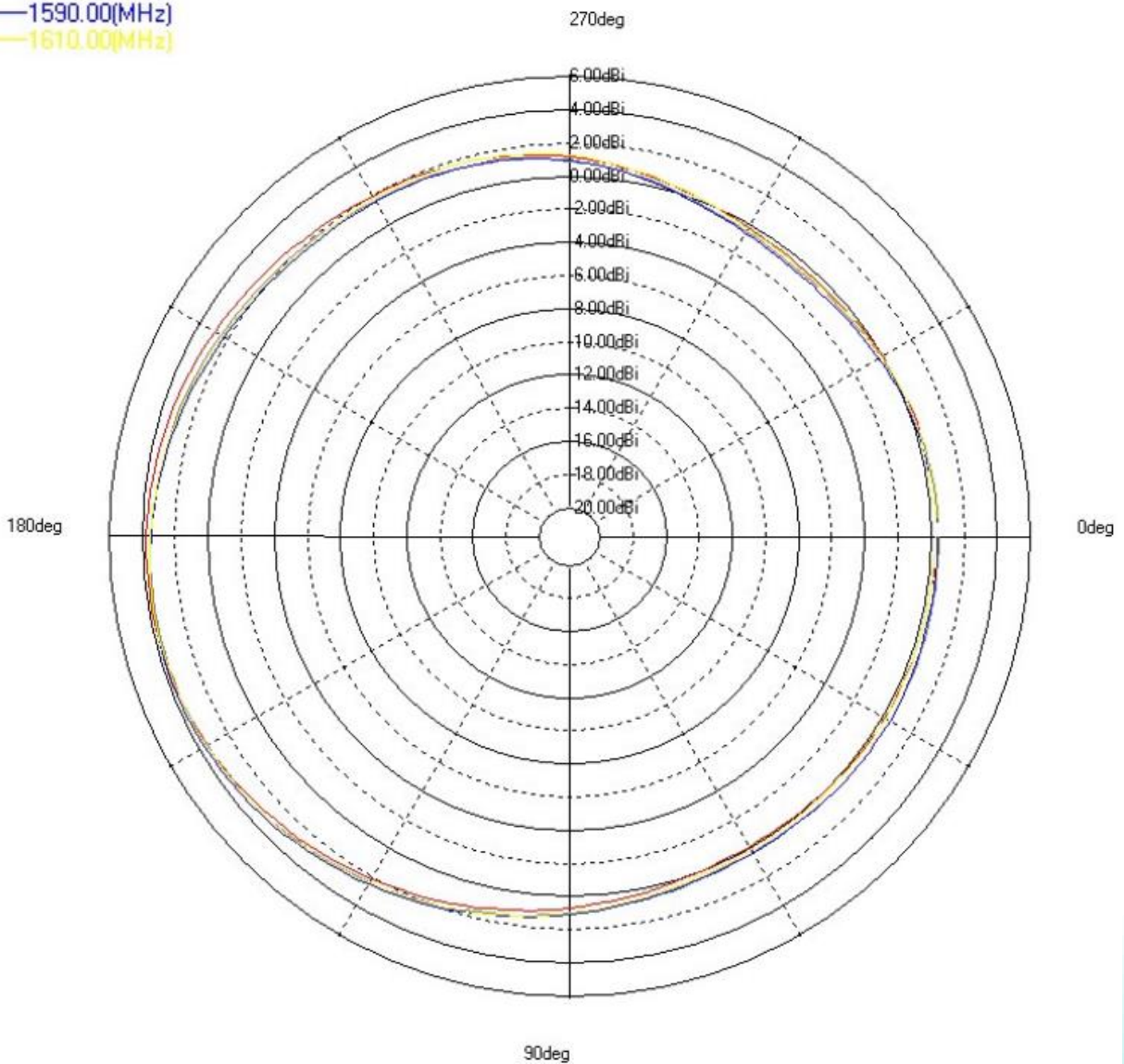

Issue: 2035

In the effort to improve our products, we reserve the right to make changes judged to be necessary.

CONFIDENTIAL AND PROPRIETARY INFORMATION

This document contains confidential and proprietary information of Pulse Electronics, Inc. (Pulse) and is protected by copyright, trade secret and other state and federal laws. Its receipt or possession does not convey any rights to reproduce, disclose its contents, or to manufacture, use or sell anything it may describe. Reproduction, disclosure or use without specific written authorization of Pulse is strictly forbidden.

Series: Satellite Navigation System

Description: Antenna GPS/GLONASS/
Beidou/Galileo

PART NUMBER: W3010

Recommendations for ceramic chip antenna storage

Storage time

Products should be used within 6 months from the day of manufacturers packaging even when they are stored under below mentioned conditions. Longer storage period may decrease the component solderability.

Storage environmental conditions

To maintain solderability of Pulse ceramic products care must be taken to control the storage and use conditions:

- Do not store or use products in a corrosive atmosphere, especially where chloride, sulphur or sulfide, alkali or acid salts exist in the air. Corrosive gases may cause oxidation of electrodes and reduce solderability
- Keep temperature and humidity stable and do not exceed the below mentioned minimum and maximum conditions: Temperature: -10 to +30 Deg C
Humidity: below 60% RH
- Do not store the products under direct sun light.

It is recommended to keep the products in manufacturers packing (tape&reel) until the time of assembly and soldering process. Air tight vacuum package is recommended in the conditions where it is know to be some corrosive gases.

Handling

Do not touch the components with bare hands. Protective gloves must be used to prevent contamination of terminals which may cause reduced solderability. Do not touch or damage the silver plated surface by any sharp objects. Soft materials (plastic, wood etc.) must be used if tweezers or other tools are used to pick the components. Avoid any excess mechanical shock or vibration during storage and handling.

Issue: 2035

In the effort to improve our products, we reserve the right to make changes judged to be necessary.

CONFIDENTIAL AND PROPRIETARY INFORMATION

This document contains confidential and proprietary information of Pulse Electronics, Inc. (Pulse) and is protected by copyright, trade secret and other state and federal laws. Its receipt or possession does not convey any rights to reproduce, disclose its contents, or to manufacture, use or sell anything it may describe. Reproduction, disclosure or use without specific written authorization of Pulse is strictly forbidden.

Downloaded From Oneyac.com

Series: Satellite Navigation System

Description: Antenna GPS/GLONASS/
Beidou/Galileo

PART NUMBER: W3010

Recommendations for reflow soldering process

Printing stencil thickness 0,15 - 0,25 mm is recommended for the solder paste. The maximum soldering temperature should not exceed 260°C. The temperature profile recommendations for reflow soldering process is presented in the Figures 1 and 2. The reflow profile

presented in figure 1 describes minimum reflow temperatures. The reflow profile presented in figure 2 describes maximum reflow temperatures. located at the center of the coverage area.

	Method of heat transfer	Controlled hot air convection
1	Average temperature gradient in preheating	2.5 °C/s
2	Soak time	2-3 minutes
3	Max temperature gradient in reflow	3 °C/s
4	Time above 217 °C	Max 30 sec
5	Peak temperature in reflow	230 °C for 10 seconds
6	Temperature gradient in cooling	Max -5 °C/s

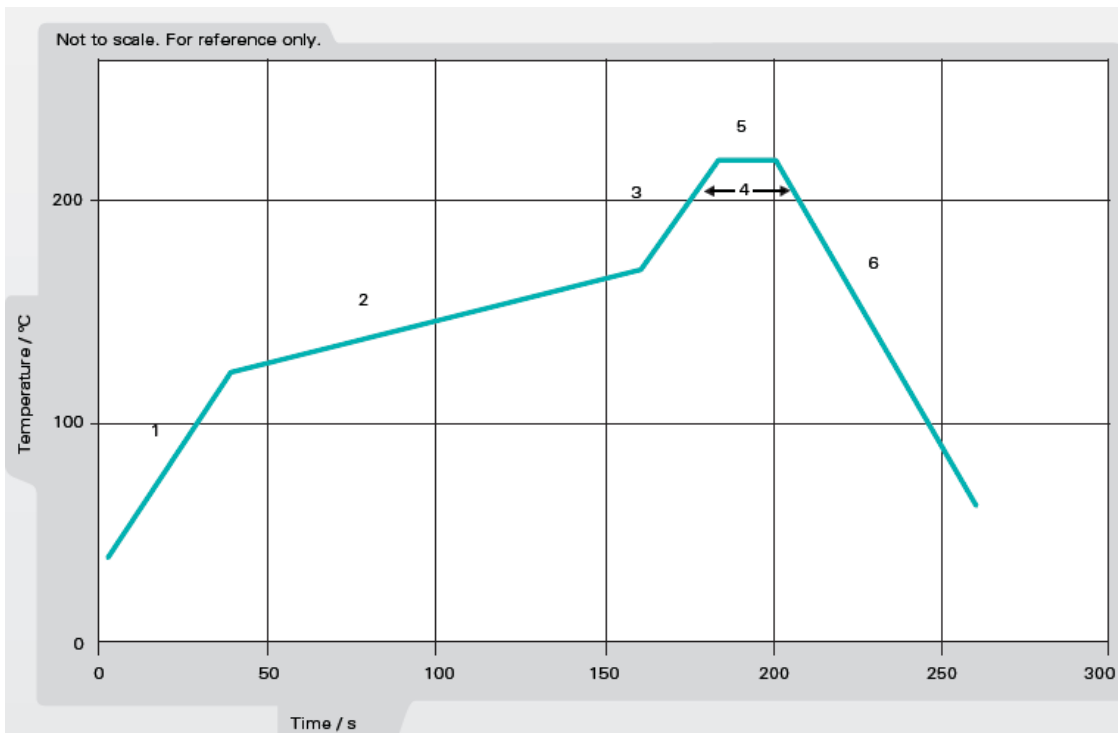

Figure 1. Minimum temperature profile recommendation for reflow soldering process

Issue: 2035

In the effort to improve our products, we reserve the right to make changes judged to be necessary.

CONFIDENTIAL AND PROPRIETARY INFORMATION

This document contains confidential and proprietary information of Pulse Electronics, Inc. (Pulse) and is protected by copyright, trade secret and other state and federal laws. Its receipt or possession does not convey any rights to reproduce, disclose its contents, or to manufacture, use or sell anything it may describe. Reproduction, disclosure or use without specific written authorization of Pulse is strictly forbidden.

Series: Satellite Navigation System

Description: Antenna GPS/GLONASS/
Beidou/Galileo

PART NUMBER: W3010

Recommendations for reflow soldering process

	Method of heat transfer	Controlled hot air convection
1	Average temperature gradient in preheating	2.5 °C/s
2	Soak time	2-3 minutes
3	Max temperature gradient in reflow	3 °C/s
4	Time above 217 °C	Max 60 sec
5	Time above 230 °C	Max 50 sec
6	Time above 250 °C	Max 10 sec
7	Peak temperature in reflow	260 °C for 5 seconds
8	Temperature gradient in cooling	Max -5 °C/s

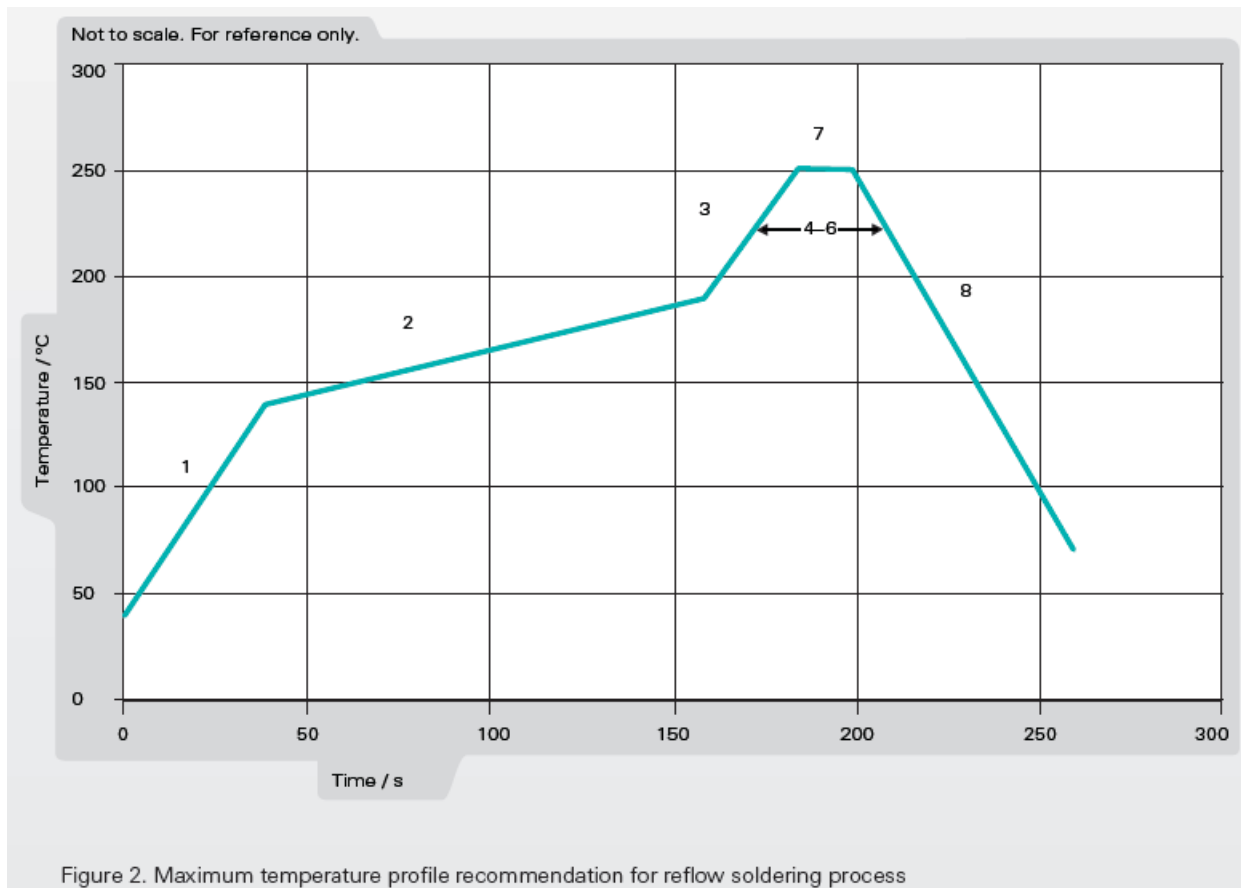

Issue: 2035

In the effort to improve our products, we reserve the right to make changes judged to be necessary.

CONFIDENTIAL AND PROPRIETARY INFORMATION

This document contains confidential and proprietary information of Pulse Electronics, Inc. (Pulse) and is protected by copyright, trade secret and other state and federal laws. Its receipt or possession does not convey any rights to reproduce, disclose its contents, or to manufacture, use or sell anything it may describe. Reproduction, disclosure or use without specific written authorization of Pulse is strictly forbidden.

Series: Satellite Navigation System

Description: Antenna GPS/GLONASS/
Beidou/Galileo

PART NUMBER: W3010

PACKAGING

Taping package
1000PCS/Reel
3000PCS/Small box
6000PCS/Carton box

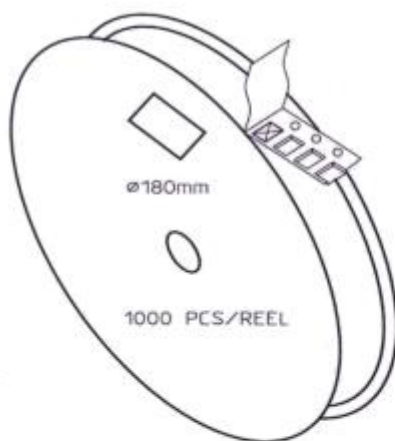

CARRIER TAPE H85-00188
width=24,00 depth=2.20
COVER TAPE H85-00159
width=21.20

LENGTH OF TAPE:

- Leader section: min 350 mm before component section
- Trailer section: min 40 mm after component section.

Empty part cavities at leader and trailer section of the tape must be sealed with top cover tape.

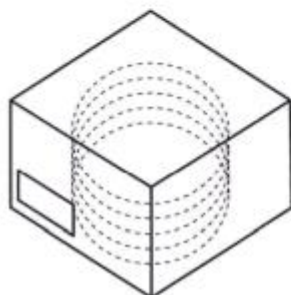

BOX H85-00128 (182x182x125)	1 pcs
- LABEL	1 pcs/BOX
REEL H85-00160 (D180 , W28)	4 pcs
- REEL LABEL	1 pcs/REEL

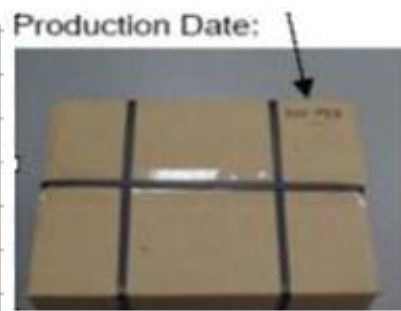

Issue: 2035

In the effort to improve our products, we reserve the right to make changes judged to be necessary.

CONFIDENTIAL AND PROPRIETARY INFORMATION

This document contains confidential and proprietary information of Pulse Electronics, Inc. (Pulse) and is protected by copyright, trade secret and other state and federal laws. Its receipt or possession does not convey any rights to reproduce, disclose its contents, or to manufacture, use or sell anything it may describe. Reproduction, disclosure or use without specific written authorization of Pulse is strictly forbidden.

单击下面可查看定价，库存，交付和生命周期等信息

[>>Pulse\(普思\)](#)