

SMT Common Mode Inductors

0.5A to 3.6A



- Pick and place compatible
- Rated voltage 250Vac
- Low RFI toroid
- Tape & Reel packaging available

Electrical Specifications @ 25°C - Operating Temperature -40°C to +125°C³

Part 1,2 Number	Inductance (mH MIN)	I _{rated} (A)	DCR (MAX) (mΩ)	Typical SRF (MHz)	Impedance Curve	Size Code	Weight (Grams)	Quantity In Tube
PE-53914NL	13.2	0.50	850	0.3	5	LCCI-37	2.4	30
PE-53913NL	6.0	1.00	450	0.5	4	LCCI-37	2.4	30
PE-53912NL	1.8	2.50	80	2.2	3	LCCI-50	5.2	30
PE-53911NL	0.9	1.50	60	2	2	LCCI-37	2.5	30
PE-53910NL	0.6	3.60	50	4	1	LCCI-50	5.3	30

Notes:

- Optional Tape & Reel packaging can be ordered by adding a "T" suffix to the part number (i.e. PE-53914L becomes PE-53914LT). Pulse complies to industry standard tape and reel specification EIA481.
- The "NL" suffix indicates an RoHS-compliant part number. Non-NL suffixed parts are not necessarily RoHS compliant, but are electrically and mechanically equivalent to NL versions. If a part number does not have the "NL" suffix, but an RoHS compliant version is required, please contact Pulse for availability.
- The temperature of the component (ambient plus temperature rise) must be within the stated operating temperature range.

Mechanicals

Schematics

PE-XXXXNL

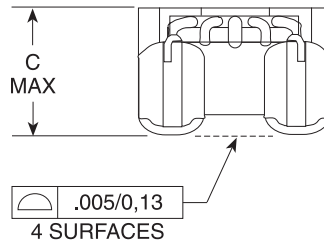
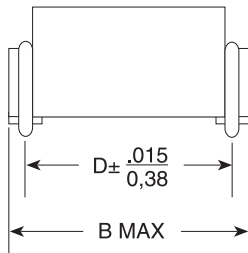
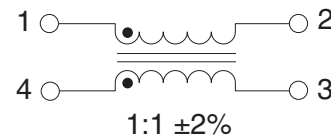
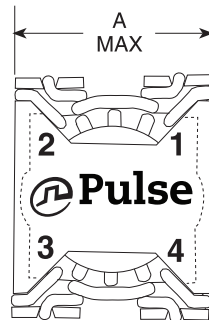
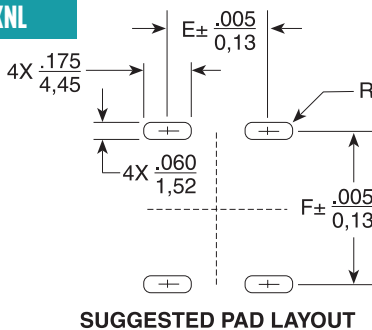

Size	A	B	C	D	E	F
LCCI-37	.560/14,22	.645/16,38	.350/8,89	.520/13,21	.340/8,64	.530/13,46
LCCI-50	.670/17,02	.770/19,56	.390/9,90	.650/16,51	.445/11,30	.660/16,76

SMT Common Mode Inductors

0.5A to 3.6A

Typical Impedance Curves

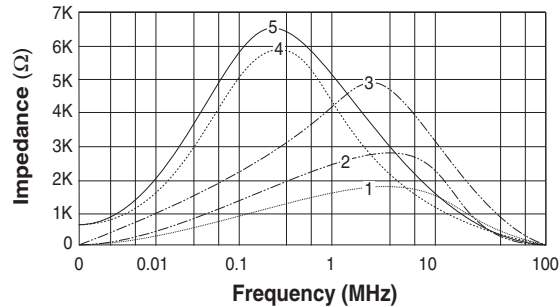

Application

These transformers have been designed for use at the interface between line driver and receiver and the interconnecting medium in Digital Audio Data Transmission Systems according to AES 3-199X or IEC 958. In such systems, two channels of periodically sampled and uniformly quantized audio signals are transmit on a single shielded twisted pair.

The electrical parameters of the interface are based on those of CCITT V.11 or balanced voltage digital circuits which allow signal transmission up to a few hundred meters. The isolation transformers are essential in improving the balance of the transmitter and the receiver circuitry, and reducing common mode noise and EMI.

These transformers are recommended for use with the Cirrus Logic CS8401, CS8402, CS8403 and CS8404 “Digital Audio Interface Transmit Device. The schematic below represents an implementation of transmit and receive circuits using isolation transformers at both ends. Equalization in the receiver may permit to increase the length of the interconnecting cable.

Applicable Documents

AES 3-1985 (ANSI S4.40-1985), AES 3-199XDraft, IEC 958, CP-340, EBU 3250

Application Chart

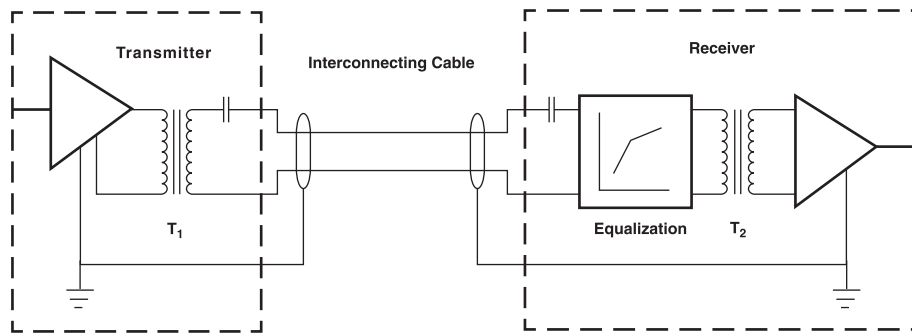

T₁, T₂: PE-65612 or PE-65812

For More Information

Pulse Worldwide Headquarters

15255 Innovation Drive Ste 100
San Diego, CA 92128
U.S.A.

Pulse Europe

Pulse Electronics GmbH
Am Rottland 12
58540 Meinerzhagen
Germany

Pulse China Headquarters

Pulse Electronics (ShenZhen) CO., LTD
D708, Shenzhen Academy of
Aerospace Technology,
The 10th Keji South Road,
Nanshan District, Shenzhen,
P.R. China 518057

Pulse North China

Room 2704/2705
Super Ocean Finance Ctr.
2067 Yan An Road West
Shanghai 200336
China

Pulse South Asia

3 Fraser Street 0428
DUO Tower
Singapore 189352

Pulse North Asia

1F., No.111 Xiyuan Road
Zhongli District
Taoyuan City 32057
Taiwan (R.O.C)

Tel: 858 674 8100
Fax: 858 674 8262

Tel: 49 2354 777 100
Fax: 49 2354 777 168

Tel: 86 755 33966678
Fax: 86 755 33966700

Tel: 86 21 62787060
Fax: 86 2162786973

Tel: 65 6287 8998
Fax: 65 6280 0080

Tel: 886 3 4356768
Fax: 886 3 4356820

Performance warranty of products offered on this data sheet is limited to the parameters specified. Data is subject to change without notice. Other brand and product names mentioned herein may be trademarks or registered trademarks of their respective owners. © Copyright, 2019. Pulse Electronics, Inc. All rights reserved.

单击下面可查看定价，库存，交付和生命周期等信息

[>>Pulse\(普思\)](#)