

1 適用範圍

- 1.1 本規範適用於RST系列低阻無鉛、無鹵素符合RoHS條款的厚膜晶片電阻器。
- 1.2 具優良的耐硫性能(參考ASTM-B-809-95&EIA977硫蒸氣試驗)。
- 1.3 該產品應用於一般電子用途。

2 型別名稱

(例)

型別	尺寸	電阻值		容差	硫化測試	包裝型式(請參閱 IE-SP-054)
耐硫化系列 低阻值 厚膜晶片電阻器	02(0402) 03(0603) 05(0805) 06(1206) 12(1210) 20(2010) 25(2512)	4-碼	EX. 0.1Ω=R100	F=± 1% J=± 5%%	A : 60°C	TH : 2 mm Pitch Carrier Tape 10000 pcs H1 : 2 mm Pitch Carrier Tape 20000 pcs H2 : 2 mm Pitch Carrier Tape 20000 pcs H3 : 2 mm Pitch Carrier Tape 30000 pcs H4 : 2 mm Pitch Carrier Tape 40000 pcs H5 : 2 mm Pitch Carrier Tape 50000 pcs H6 : 2 mm Pitch Carrier Tape 60000 pcs TP : 4 mm Pitch Carrier Tape 5000 pcs P2 : 4 mm Pitch Carrier Tape 10000 pcs P3 : 4 mm Pitch Carrier Tape 15000 pcs P4 : 4 mm Pitch Carrier Tape 20000 pcs

3 規格表

型別	額定功率	最高額定電流	最高過負荷電流	T.C.R (ppm / °C) 溫度係數	阻值範圍
					F(±1%)、J(±5%) E-24、E-96
RST02 (0402)	$\frac{1}{16}$ W	1.44A	3.60A	±1500	$30\text{m}\Omega \leq R < 37\text{m}\Omega$
				±1200	$37\text{m}\Omega \leq R < 60\text{m}\Omega$
				±600	$60\text{m}\Omega \leq R < 100\text{m}\Omega$
				±500	$100\text{m}\Omega \leq R < 400\text{m}\Omega$
				±300	$400\text{m}\Omega \leq R < 1000\text{m}\Omega$
RST03 (0603)	$\frac{1}{10}$ W	1.82A	4.56A	±1500	$30\text{m}\Omega \leq R < 37\text{m}\Omega$
				±1200	$37\text{m}\Omega \leq R < 60\text{m}\Omega$
				±600	$60\text{m}\Omega \leq R < 100\text{m}\Omega$
				±200	$100\text{m}\Omega \leq R < 1000\text{m}\Omega$
RST05 (0805)	$\frac{1}{8}$ W	2.50A	6.25A	±1200	$20\text{m}\Omega \leq R < 33\text{m}\Omega$
				±800	$33\text{m}\Omega \leq R < 50\text{m}\Omega$
				±600	$50\text{m}\Omega \leq R < 100\text{m}\Omega$
				±300	$100\text{m}\Omega \leq R < 1000\text{m}\Omega$
RST06 (1206)	$\frac{1}{3}$ W	4.08A	10.20A	±1200	$20\text{m}\Omega \leq R < 25\text{m}\Omega$
				±1000	$25\text{m}\Omega \leq R < 50\text{m}\Omega$
				±600	$50\text{m}\Omega \leq R < 100\text{m}\Omega$
				±300	$100\text{m}\Omega \leq R < 1000\text{m}\Omega$
RST12 (1210)	$\frac{1}{2}$ W	5.00A	12.50A	±1000	$20\text{m}\Omega \leq R < 25\text{m}\Omega$
				±700	$25\text{m}\Omega \leq R < 50\text{m}\Omega$
				±400	$50\text{m}\Omega \leq R < 100\text{m}\Omega$
				±300	$100\text{m}\Omega \leq R < 1000\text{m}\Omega$
RST20 (2010)	$\frac{3}{4}$ W	6.12A	15.31A	±1200	$20\text{m}\Omega \leq R < 25\text{m}\Omega$
				±900	$25\text{m}\Omega \leq R < 50\text{m}\Omega$
				±500	$50\text{m}\Omega \leq R < 100\text{m}\Omega$
				±300	$100\text{m}\Omega \leq R < 1000\text{m}\Omega$
RST25 (2512)	1W	7.07A	17.67A	±1200	$20\text{m}\Omega \leq R < 25\text{m}\Omega$
				±900	$25\text{m}\Omega \leq R < 50\text{m}\Omega$
				±500	$50\text{m}\Omega \leq R < 100\text{m}\Omega$
				±300	$100\text{m}\Omega \leq R < 1000\text{m}\Omega$
使用溫度範圍				-55°C ~ +155°C	

3.1 功率衰減曲線：

使用溫度範圍：- 55 ~ +155 °C

周圍溫度若超過70°C至155°C之間，功率可照下圖曲線予以修定之。

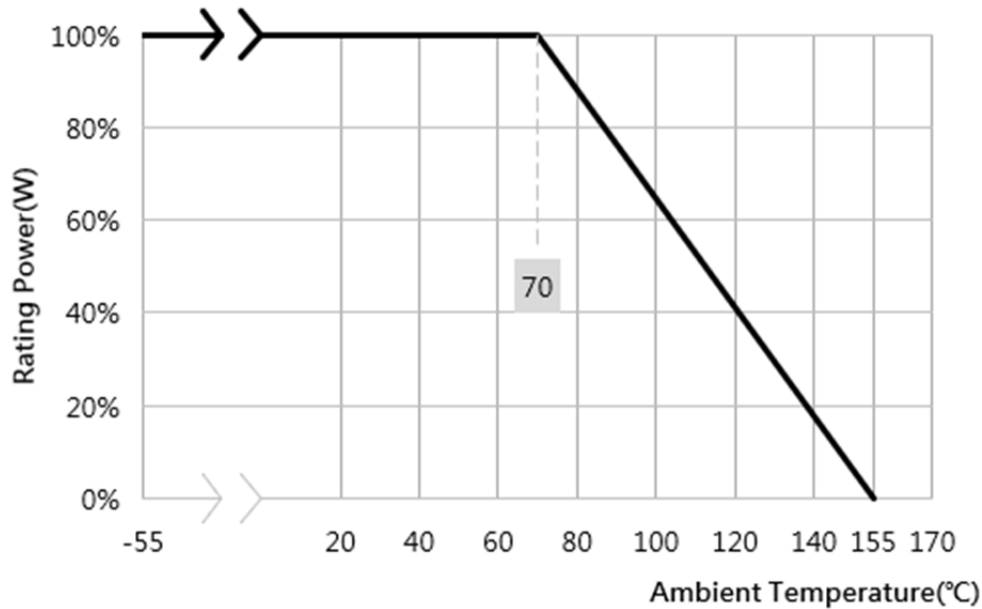

3.2 額定電流：

對於額定功率之直流或交流(商用週率有效值rms.)電流。

可用下列公式求得，但求得之值若超過規格表內之最高電流時，則以最高額定電流為其額定電流。

$$I = \sqrt{P/R}$$

I=額定電流(A)
 P=額定功率(W)
 R=公稱阻值(Ω)

4 尺寸

Unit : mm

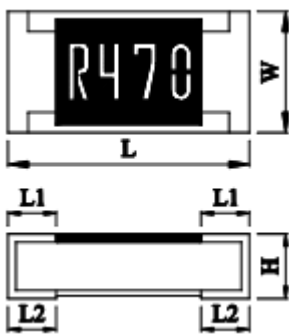

Dimension		L	W	H	L1	L2
Type	Size Code					
RST02	0402	1.00±0.10	0.50±0.05	0.30±0.10	0.25±0.10	0.20±0.15
RST03	0603	1.60±0.10	0.80±0.10	0.45±0.10	0.25±0.15	0.35±0.15
RST05	0805	2.00±0.10	1.25±0.10	0.50±0.10	0.35±0.20	0.35±0.20
RST06	1206	3.05±0.10	1.55±0.10	0.50±0.10	0.45±0.20	0.55±0.25
RST12	1210	3.05±0.10	2.55±0.10	0.55±0.10	0.50±0.20	0.50±0.20
RST20	2010	5.00±0.20	2.50±0.20	0.60±0.10	0.65±0.20	0.65±0.20
RST25	2512	6.30±0.20	3.20±0.20	0.60±0.10	0.65±0.20	0.65±0.20

5 結構圖

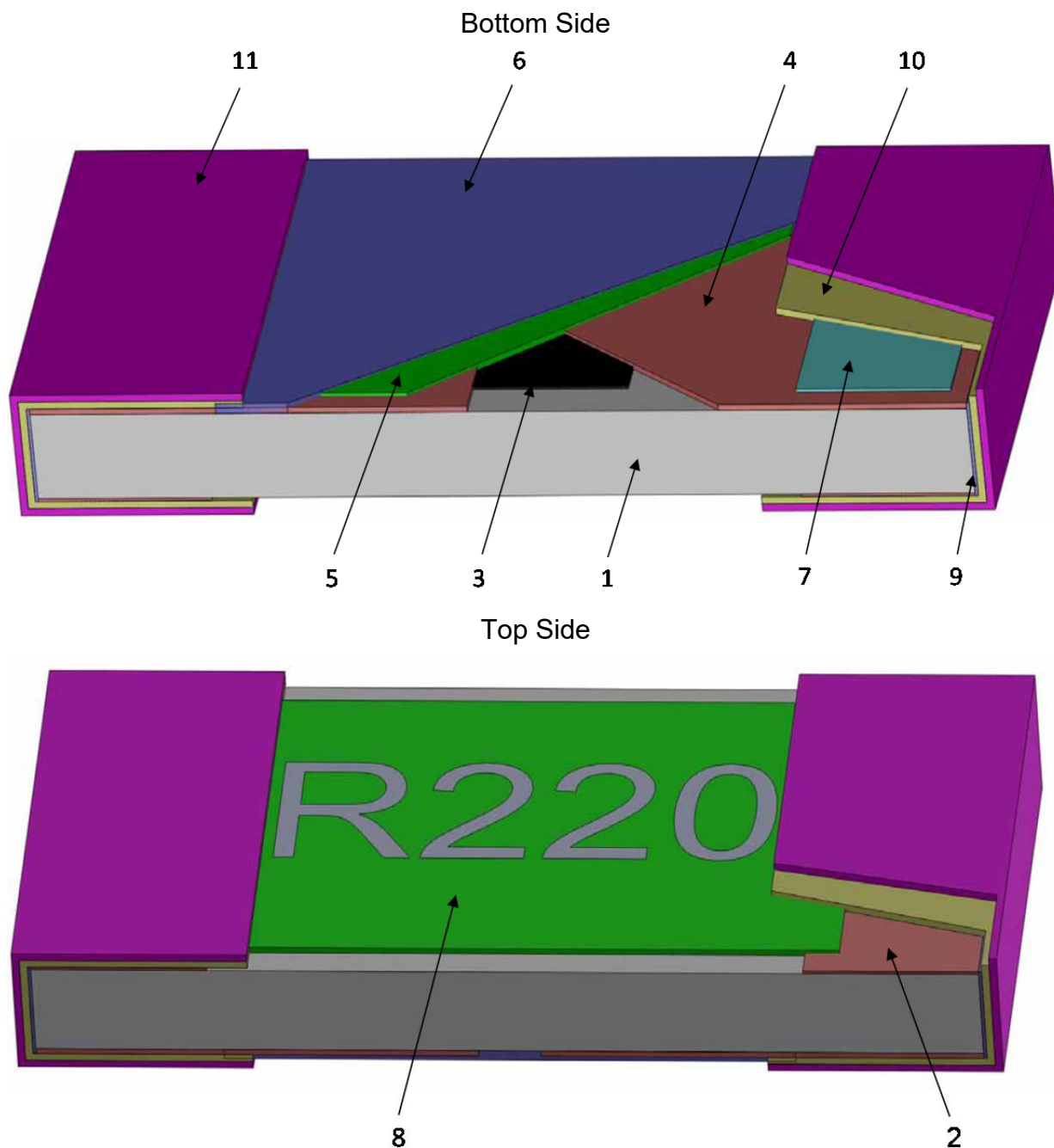

1	陶瓷基板	Ceramic substrate	7	2nd背面內部電極	2nd Bottom inner electrode
2	正面內部電極	Top inner electrode	8	G2+MK層	G2 layer+Marking
3	電阻層	Resistive layer	9	側面內部電極	Terminal inner electrode
4	1st背面內部電極	1stBottom inner electrode	10	Ni層電鍍	Ni plating
5	1st保護層	1st Protective coating	11	Sn層電鍍	Sn plating
6	2nd保護層	2nd Protective coating			

6 信賴性試驗項目

Item	Conditions	Specifications
		Resistors
High Temperature Exposure (Storage)	Put the specimens in the chamber with temperature of $155\pm 3^{\circ}\text{C}$ for 1000 hours. Then take them out to stabilize in room temperature for 24 ± 4 hr or more, and measure of its resistance variance rate. Experiment evidence: AEC-Q200	$\Delta R\% = \pm 2.0\%$
Temperature Cycling	$-55\sim +155^{\circ}\text{C}$, soak time 30min · Transition Time :1minute, 1000 cycles . JESD22 Method JA-104	$\Delta R\% = \pm 2.0\%$
Short Time Overload	Applied 2.5 times rated current for 5 seconds and release the load for about 30 minutes, then measure its resistance variance rate. (Rated current refers to item 3. general specifications) Refer to JIS-C5201-1 4.13	$\Delta R\% = \pm 2.0\%$
Biased Humidity	Solder the specimens on the test PCB and put them into the constant temperature humidity chamber with $85\pm 2^{\circ}\text{C}$ and $85\pm 5\% \text{RH}$. Then apply the test voltage that calculates based on the 10% of rated power for 1000hrs. Then take them out to stabilize in room temperature for 24 ± 4 hr or more, and measure of its resistance variance rate. Experiment evidence: AEC-Q200	$\Delta R\% = \pm 3.0\%$
Operational Life	Put the tested resistor in chamber under temperature $70\pm 2^{\circ}\text{C}$ and load the rated voltage for 90 minutes on, 30 minutes off, total 1000 hours. Then leaving the tested resistor in room temperature for 60 minutes, and measure its resistance variance rate MIL-STD-202 Method 108	$\Delta R\% = \pm 3.0\%$
Resistance to Soldering Heat	The specimens are fully immersed into the Pb-free solder pot, then take them out to stabilize for 1 hour or more and measure of its resistance variance rate. Temp of solder pot : $260\pm 5^{\circ}\text{C}$ Soldering duration : 10 ± 1 sec. Experiment evidence AEC-Q200	$\Delta R\% = \pm 2.0\%$

Item	Conditions	Specifications
		Resistors
ESD	Put the specimens on the test fixture and two (2)discharges (2KVDC) shall be applied to each PUT, one (1) with a positive polarity and one (1) with a negative polarity. Afterwards, the specimens stabilize for 30min or more and measure of its resistance variance rate. The test is performed with direct contact and regular discharge mode. The resistor and capacitor used on the spearhead is 2000Ω and 150pF respectively. Experiment evidence AEC-Q200	ΔR%= ±3.0%
Solderability	Test method: Test item 1 (solder pot test): Method B Precondition: The specimens are subjected to 155°C dry bake for 4hrs±15min. The specimens are immersed into the flux first, then fully immersed into the solder pot, at a temperature of 235± 5°C for 5+0/-0.5 sec. Then rinse with water and observe the soldering coverage under the microscope. Test item 2 (Leaching test): Method D The specimens are immersed into the flux first, then fully immersed into the solder pot, at a temperature of 260±5°C for 30+0/-0.5 sec. Then rinse with water and observe the soldering coverage under the microscope. Experiment evidence AEC-Q200	1.Soldering coverage over 95% 2.At the edge of terminal, the object underneath (e.g. white ceramic) shall not expose.
Electrical Characterization	$TCR(ppm/^{\circ}C) = \frac{(R2-R1)}{R1(T2-T1)} \times 10^6$ R1: Resistance at room temperature (Ω) R2: Resistance at -55°C or +125°C(Ω) T1: Room temperature (°C) T2: Temperature -55°C or +125°C Experiment evidence: AEC-Q200	Refer to item 3. General specifications

Item	Conditions		Specifications	
			Resistors	
Board Flex (Bending Test)	Solder the specimens on the test PCB and put the PCBA onto the Bending Tester. Add force at the central part of PCB, and the duration of the applied forces shall be 60 (+ 5) Sec. Measure of its resistance variance rate in load. Bending depth (D) : 0402 · 0603 · 0805=5mm 1206 · 1210=3mm 2010 · 2512=2mm Experiment evidence: AEC-Q200		$\Delta R = \pm 2.0\%$ No mechanical damage, peel-off of side end or chip crack.	
Sulfuration Test	Class : A	Put the tested resistor in sulfur vapor, at a temperature of $60 \pm 2^\circ\text{C}$ for 1000hrs Refer to ASTM-B-809-95&EIA977	$\Delta R = \pm 4.0\%$	Refer to item 3. general specifications

7 阻值測試包裝標準量測位置

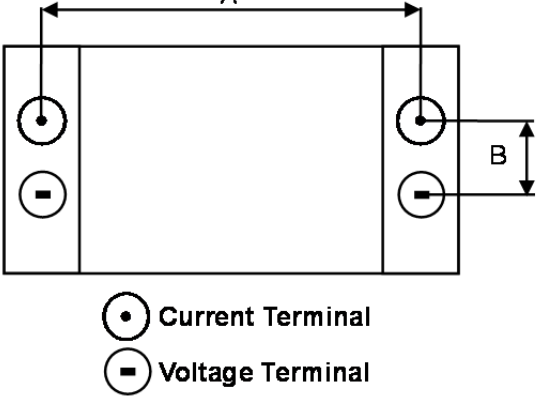
背面電極量測		Unit : mm		
		DIM		
		TYPE	A	B
		RST02	0.80±0.05	0.24±0.05
		RST03	1.35±0.05	0.35±0.05
		RST05	1.80±0.05	0.35±0.05
		RST06	2.90±0.05	0.35±0.05
		RST12	2.90±0.05	0.35±0.05
		RST20	4.50±0.05	1.15±0.05
		RST25	5.90±0.05	1.60±0.05

8 鍍層厚度

8.1 鎳層厚度： $\geq 2\mu\text{m}$

8.2 純錫： $\geq 3\mu\text{m}$

8.3 電鍍純錫為霧錫

9 包裝空料數規定

9.1 每一Reel空料數未超過該捲總數0.1%及連續2顆(含)以上時，是被允許的。

10 技術應用說明(此為建議，請客戶使用時依實際應用作調整)

10.1 建議焊錫條件：

(a) Lead Free IR Reflow Soldering Profile(符合J-STD-020)

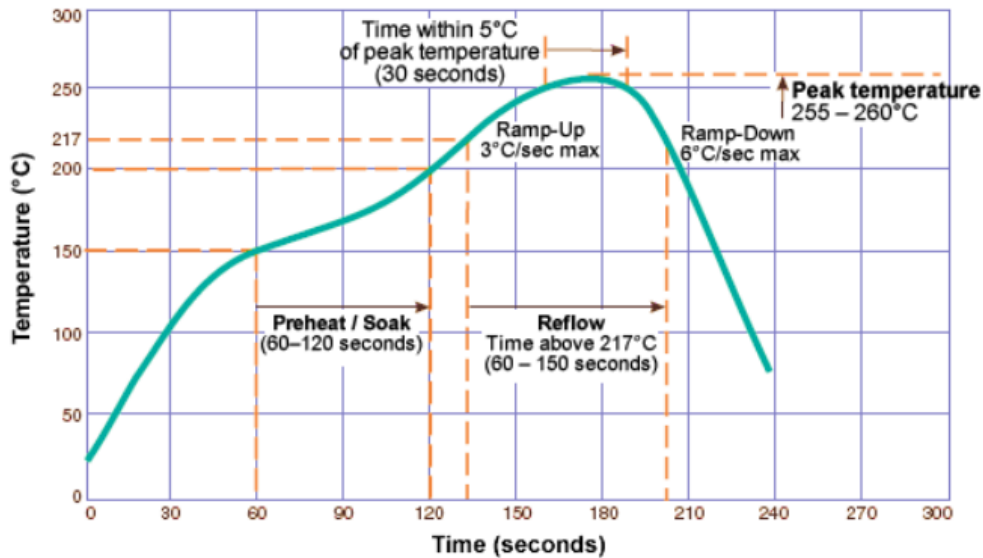

備註：零件最高耐溫 260 +5/-0 °C · 10 秒。

(b) Lead Free Double-Wave Soldering Profile(適用0603(含)以上之產品)

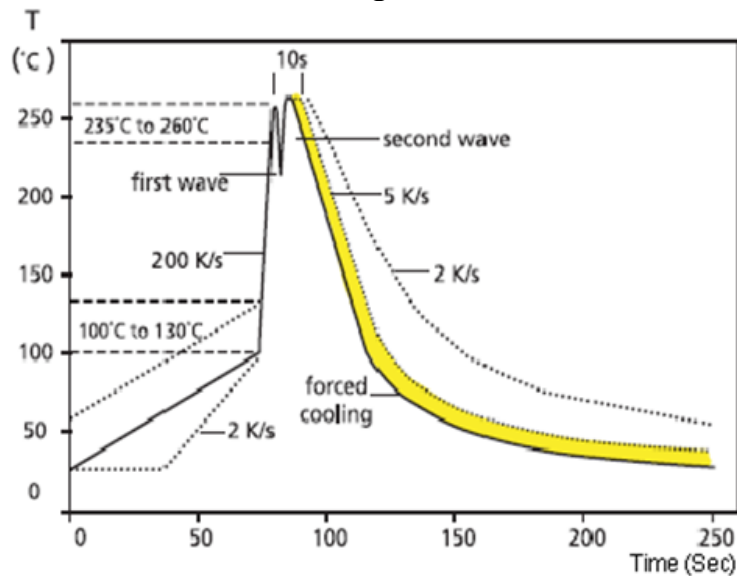

(c) 烙鐵焊錫方法：350±10°C 3秒之內。

10.2 建議 Land Pattern Design (For Reflow Soldering) :

當元件被焊接時，焊接後的電阻值根據焊接區域的大小和焊接量的不同而稍有變化。設計電路時，有必要考慮其電阻值降低或增加的影響。

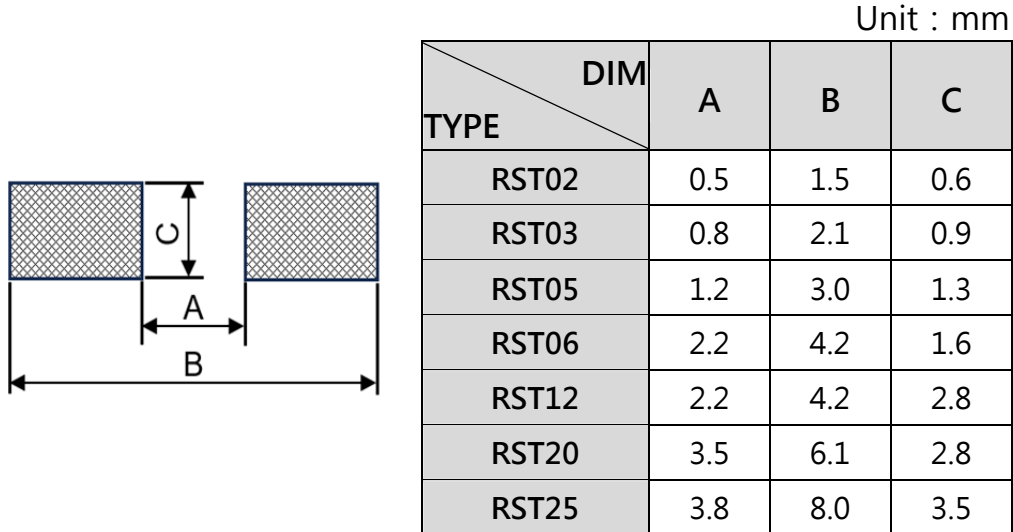

10.3 使用環境注意事項：

此規格產品為一般電子用途，RALEC將不為任何使用在特殊環境下，使用此規格產品導致之損害、費用或損失負責，如有其他應用需與RALEC進行確認是否適用。若客戶端有意於特殊環境或狀態下使用本公司產品(包括但不限於如下所示)，則需針對下列或其他運用環境各別承認產品特性及信賴性。

- (a) 運用於高溫高濕之環境；
- (b) 於接觸海風或運用於其他腐蝕性氣體之環境:Cl₂、H₂S、NH₃、SO₂及NO₂；
- (c) 於非驗證過液體中使用，包括水、油、化學品及有機溶劑；
- (d) 使用非驗證過之樹脂或其他塗層材料來封合或塗層本公司產品；
- (e) 於焊錫後之清洗，需使用水溶性清潔劑清洗殘留於產品助焊劑，縱然使用免洗助焊劑仍建議清洗。

10.4 暫態過載注意事項：

本產品可能對於暫態過載而導致產品之功能喪失，請注意您的製造過程和保存，避免發生高於產品規格之暫態電流施加在產品上

10.5 作業及處理注意事項：

- (a) 作業時需確保電阻邊緣及保護層免於機械應力破壞。
- (b) 印刷電路板 (PCB) 分開或固定在支撐體上時應小心操作，因為印刷電路板 (PCB) 安裝的彎曲會對電阻器造成機械應力。
- (c) 電阻需於規格中額定功率範圍內使用，尤其當功率超出額定值時，將會負載在電阻上，有可能因溫度上升造成機器損害。
- (d) 若電阻短時間將可能承受大量負載(脈衝波)衝擊時，必須於使用前設置作業環境。
- (e) 使用該產品時請在貴司實裝狀態下評估及確認，充分考慮故障安全設計，確保系統上的安全性。

11 儲存及搬運條件

- 11.1 在儲存環境 $25\pm 5^{\circ}\text{C}$ 、 $60\pm 15\%$ 之條件下可儲存二年。
- 11.2 存儲時請避開如下惡劣環境，以免影響產品性能及焊錫連接性：海風、 Cl_2 、 H_2S 、 NH_3 、 SO_2 及 NO_2 等腐蝕性氣體的場所，陽光直射、結露場所。
- 11.3 產品搬運、存儲時請保證箱體的正確朝向，嚴禁摔落、擠壓箱體，否則可能造成產品電極或本體受損。

12 電子信息產品標示外箱上以下列標籤進行標示(外銷中國大陸)

	
<p>電子信息產品污染控制標誌</p>	<p>包裝回收標誌</p>

13 附件

- 13.1 文件修訂記錄表(QA-QR-027)

法律免責聲明

RALEC 及其經銷商與代理商(以下統稱“ RALEC”)不因任何產品相關資訊(包括但不限於產品規格、資料、圖片和圖表)中包含的任何錯誤、不正確或不完整，而承擔任何責任。RALEC 可能隨時對產品相關資訊進行更改、修訂或改善，恕不另行通知。

RALEC 對於其產品使用於特殊目的之適用性或其任何產品的持續生產不為任何承諾、保證及/或擔保。在法律准許的最大程度內，RALEC 不承擔任何下述之責任：(i)因應用或使用任何 RALEC 產品而產生之任何及所有責任，(ii)任何及所有責任，包括但不限於因 RALEC 產品所造成或與 RALEC 產品相關的利潤損失或是直接損害、間接損害、特別損害、懲罰性損害、衍生性損害或附帶性損害，及(iii)任何及所有默示保證，包括產品適用於特殊用途、非侵權、及適銷性。

RALEC 將此產品定義為一般電子用途，不適用於任何車用電子、醫療救生或維生設備，亦不適用於當 RALEC 產品故障時，可能造成人員傷亡之任何應用上。RALEC 所提供的任何及所有的關於產品應用上的技術建議，均為無償提供，RALEC 對於採用該等技術建議及可獲取的結果，不承擔任何義務及責任，採用該等建議之所有風險，概由買方承擔。買方將 RALEC 產品使用於與其他材料或原料結合、或實施於其任何製程中之組合，所產生的所有風險及責任，概由買方承擔，不論 RALEC 對於產品的使用給予任何口頭或書面的技術說明、建議或其他。

此處所提供之資訊僅為說明產品規格，產品未變更時，RALEC 保有修改此內容不另行通知之所有權利，任何產品變更將會以 ECN 公布。