

1 Scope:

- 1.1 This specification is applicable to lead free and halogen free of RoHS directive for LRE series metal alloy low-resistance resistor.
- 1.2 The product is for general electronic purpose.

2 Explanation Of Part Numbers:

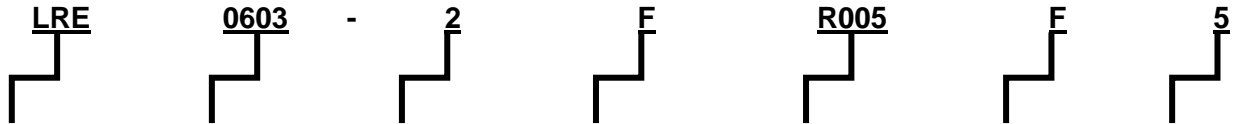

Type	Size (inch)	Number of Terminals	Rated Power	Resistance (4 Digits)	Tolerance	Packaging
Metal Alloy Low Resistance Resistor	0402 0603 0805 1206	2: 2 terminals	P=1/6W H=1/5W G=1/4W F=1/3W E=3/4W C=1/2W 1=1.0W A=1.5W	EX: R005 = 5mΩ R010 = 10mΩ	D=±0.5% F=± 1.0% G=± 2.0% J=± 5.0%	5=5,000pcs TH=10,000pcs

IE		QA		Remark IT'S NOT UNDER CONTROL FOR PDF FILE PLS NOTE THE VERSION STATED.. Do not copy without permission	Issue Dep. DATA Center. Series No. 60
Written 	Checked 	Approved 	Signing 		

3 Product Specifications:

Type	# of Terminals	Max. Rating Power	Max. Rating Current	Max. Overload Current	T.C.R. (ppm/°C)	Resistance Range (mΩ)		Operating Temperature Range
						D (±0.5%)	F (±1%) G (±2%) J (±5%)	
0402	2	1/6W	10.5A	21.0A	≤±600	--	1.5 ≤ R < 3	-55~+150°C
					≤±200	--	3	
					≤±125	--	4-5	
		≤±50	--	10				
		1/5W	11.5A	23.0A	≤±600	--	1.5 ≤ R < 3	
					≤±200	--	3	
					≤±125	--	4-5	
		≤±50	--	10				
		1/4W	9.1A	18.2A	≤±200	--	3	
≤±125	--				4-5			
≤±50	--				10			
0603	2	1/3W	18.3A	36.5A	≤±450	--	1 ≤ R < 4	
					≤±50	10 ≤ R ≤ 60	4 ≤ R ≤ 60	
		1/2W	15.8A	31.6A	≤±450	--	2 ≤ R < 4	
					≤±50	10 ≤ R ≤ 15	4 ≤ R ≤ 15	
0805	2	1/2W	15.8A	31.6A	≤±100	--	2 ≤ R < 3	
					≤±75	--	3 ≤ R < 5	
					≤±50	5 ≤ R ≤ 70	5 ≤ R ≤ 70	
		3/4W	19.36A	38.72A	≤±100	--	2 ≤ R < 3	
					≤±75	--	3 ≤ R < 5	
≤±50	5 ≤ R ≤ 10	5 ≤ R ≤ 10						
1206	2	1/2 W	22.3A	44.6A	≤±400	--	1 ≤ R < 2	
					≤±75	--	2 ≤ R < 4	
					≤±50	10 ≤ R ≤ 75	4 ≤ R ≤ 75	
		1 W	31.6A	63.2A	≤±400	--	1 ≤ R < 2	
					≤±75	--	2 ≤ R < 4	
≤±50	5 ≤ R ≤ 75	4 ≤ R ≤ 75						

Remark

IT'S NOT UNDER CONTROL FOR PDF FILE
PLS NOTE THE VERSION STATED..

Issue Dep. DATA Center.

Do not copy without permission

Series No. **60**

3.1 Power Derating Curve: Operating Temperature Range: - 55 ~+150 °C

For resistors operated in ambient temperatures 70°C, power rating shall be derated in accordance with the curve below:

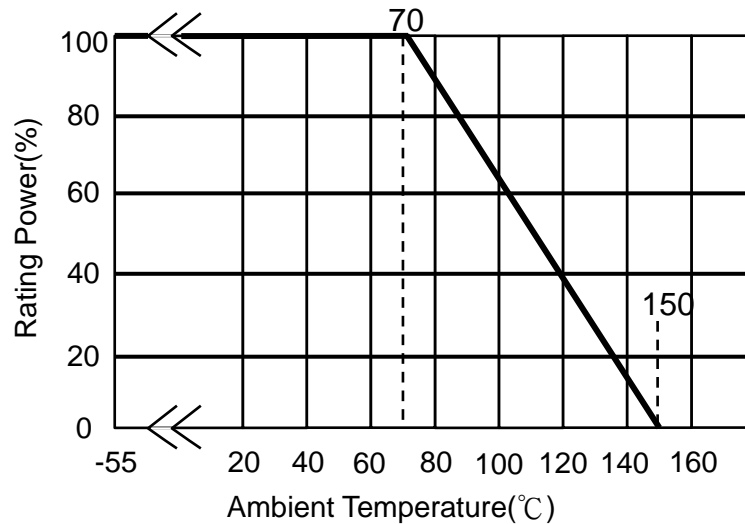

3.2 Rating Current:

Rated Current: The resistor shall have a DC continuous working current or a RMS(Root Mean Square). AC continuous working current at commercial-line frequency and wave form corresponding to the power rating, as determined from the following:

Remark:

$$I = \sqrt{P/R}$$

I=Rating Current(A)
P= Rating Power(W)
R=Resistance(Ω)

Remark

IT'S NOT UNDER CONTROL FOR PDF FILE
PLS NOTE THE VERSION STATED..

Issue Dep.**DATA Center.**

Do not copy without permission

Series No. **60**

4 Physical Dimensions:

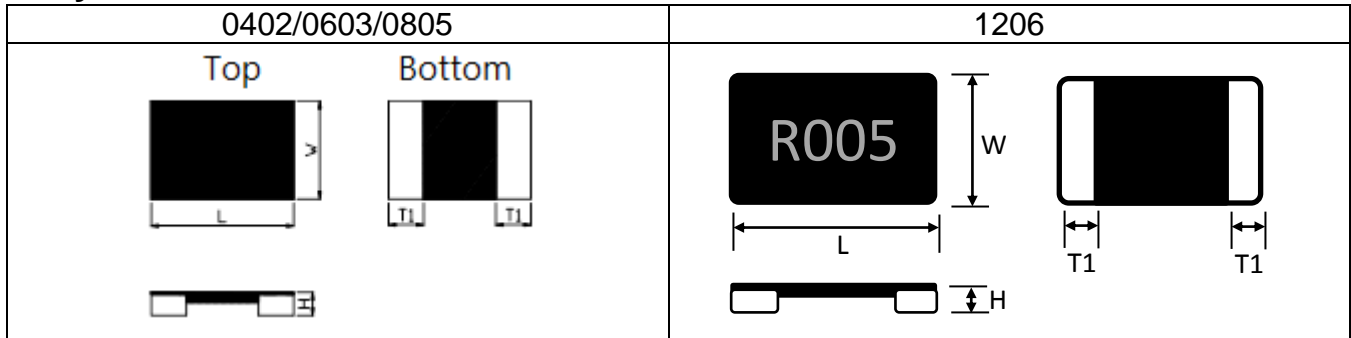

Type	Power Rating (Watts)	Resistance Range (mΩ)	L	W	H	T1
0402	1/6 & 1/5	1.5~5 10	0.039±0.004 (1.00±0.10)	0.020±0.004 (0.50±0.10)	0.010±0.004 (0.25±0.10)	0.010±0.004 (0.25±0.10)
	1/4	3~5 10	0.039±0.004 (1.00±0.10)	0.020±0.004 (0.50±0.10)	0.010±0.004 (0.25±0.10)	0.010±0.004 (0.25±0.10)
0603	1/3	1 ~ 60	0.063±0.008 (1.60±0.20)	0.031±0.008 (0.80±0.20)	0.010±0.004 (0.25±0.10)	0.012±0.006 (0.30±0.15)
	1/2	2 ~ 15				
0805	1/2 & 3/4	2	0.08±0.008 (2.032±0.20)	0.05±0.008 (1.270±0.20)	0.014 ^{+0.002} -0.004 (0.35 ^{+0.05} -0.10)	0.02±0.006 (0.50±0.15)
	1/2	3 ~ 70	0.08±0.008 (2.032±0.20)	0.05±0.008 (1.270±0.20)	0.012 ^{+0.002} -0.004 (0.30 ^{+0.05} -0.10)	0.014±0.008 (0.35±0.20)
	3/4	3 ~ 10				
1206	1/2 & 1	1 ≤ R < 3	0.126±0.008 (3.20±0.20)	0.063±0.008 (1.60±0.20)	0.016±0.008 (0.40±0.20)	0.035±0.008 (0.90±0.20)
		3 ≤ R < 4				0.024±0.008 (0.60±0.20)
		4 ≤ R ≤ 75				0.014±0.008 (0.35±0.20)

Remark

IT'S NOT UNDER CONTROL FOR PDF FILE
PLS NOTE THE VERSION STATED..

Issue Dep. **DATA Center.**

Do not copy without permission

Series No. **60**

5 Reliability Performance:

5.1 Electrical Performance:

Test Item	Conditions of Test	Test Limits															
Temperature Coefficient of Resistance (TCR)	<ul style="list-style-type: none"> TCR (ppm/°C) = $\frac{(R2-R1)}{R1 (T2-T1)} \times 10^6$ R1: resistance of room temperature R2: resistance of 150 °C T1: Room temperature T2: Temperature at 150 °C Refer to JIS C 5201-1 4.8 	Refer to Paragraph 3. general specifications															
Short Time Overload	Applied Overload for 5 seconds and release the load for about 30 minutes, then measure its resistance variance rate. (Overload condition refer to below): <table border="1" style="margin-left: 20px;"> <thead> <tr> <th>Type</th> <th>Power (W)</th> <th># of rated power</th> </tr> </thead> <tbody> <tr> <td>0402</td> <td>1/6 & 1/5 & 1/4</td> <td>4 times</td> </tr> <tr> <td>0603</td> <td>1/3 & 1/2</td> <td>4 times</td> </tr> <tr> <td>0805</td> <td>1/2 & 3/4</td> <td>4 times</td> </tr> <tr> <td>1206</td> <td>1/2 & 1.0</td> <td>4 times</td> </tr> </tbody> </table> Refer to JIS C 5201-1 4.13	Type	Power (W)	# of rated power	0402	1/6 & 1/5 & 1/4	4 times	0603	1/3 & 1/2	4 times	0805	1/2 & 3/4	4 times	1206	1/2 & 1.0	4 times	$\leq \pm 0.5\%$ No evidence of mechanical damage
Type	Power (W)	# of rated power															
0402	1/6 & 1/5 & 1/4	4 times															
0603	1/3 & 1/2	4 times															
0805	1/2 & 3/4	4 times															
1206	1/2 & 1.0	4 times															
Insulation Resistance	Put the resistor in the fixture, add 100 VDC in +, - terminal for 60secs then measured the insulation resistance between electrodes and insulating enclosure or between electrodes and base material. Refer to JIS-C5201-1 4.6	$\geq 10^8 \Omega$															
Dielectric Withstanding Voltage	Applied 300VAC for 1 minute, and Limit surge current 50 mA (max.) Refer to JIS-C5201-1 4.7	No short or burned on the appearance.															

5.2 Mechanical /Constructional Performance:

Test Item	Conditions of Test	Test Limits
Resistance to Solder Heat	The tested resistor be immersed 25 mm/sec into molten solder of 260±5°C for 10±1secs. Then the resistor is left in the room for 1 hour, and measured its resistance variance rate. Refer to JIS-C5201-1 4.18	$\leq \pm 0.5\%$ No evidence of mechanical damage
Solderability	Add flux into tested resistors, immersion into solder bath in temperature 245±5°C for 3±0.5secs. Refer to JIS-C5201-1 4.17	Solder coverage over 95%
Vibration	The resistor shall be mounted by its terminal leads to the supporting terminals on the solid table. The entire frequency range :from 10 Hz to 55 Hz and return to 10 Hz, shall be transferred in 1 min. Amplitude : 1.5mm This motion shall be applied for a period of 4 hours in each 3 mutually perpendicular directions (a total of 12hrs) Refer to JIS-C5201-1 4.22	$\leq \pm 0.5\%$ No evidence of mechanical damage
Resistance to solvent	The tested resistor be immersed into isopropyl alcohol of 20~25°C for 60secs, then the resistor is left in the room for 48 hrs. Refer to JIS-C5201-1 4.29	$\leq \pm 0.5\%$ No evidence of mechanical damage

Remark	IT'S NOT UNDER CONTROL FOR PDF FILE PLS NOTE THE VERSION STATED..	Issue Dep. DATA Center.
	Do not copy without permission	Series No. 60

5.3 Environmental Performance:

Test Item	Conditions of Test	Test Limits						
Low Temperature Exposure (Storage)	Put the tested resistor in chamber under temperature $-55\pm 2^{\circ}\text{C}$ for 1,000 hours. Then leaving the tested resistor in room temperature for 60 minutes, and measure its resistance variance rate. Refer to JIS-C5201-1 4.23.4	$\leq \pm 0.5\%$ No evidence of mechanical damage						
High Temperature Exposure (Storage)	Put tested resistor in chamber under temperature $150\pm 5^{\circ}\text{C}$ for 1,000 hours. Then leaving the tested resistor in room temperature for 60 minutes, and measure its resistance variance rate. Refer to JIS-C5201-1 4.23.2	$\leq \pm 1.0\%$ No evidence of mechanical damage						
Temperature Cycling (Rapid Temperature Change)	Put the tested resistor in the chamber under the temperature cycling which shown in the following table shall be repeated 1,000 times (0603 & 0402 for 300 times) consecutively. Then leaving the tested resistor in the room temperature for 60 minutes, and measure its resistance variance rate. <table border="1" style="margin-left: auto; margin-right: auto;"> <thead> <tr> <th colspan="2">Testing Condition</th> </tr> </thead> <tbody> <tr> <td>Lowest Temperature</td> <td>$-55 +0/-10^{\circ}\text{C}$</td> </tr> <tr> <td>Highest Temperature</td> <td>$150 +10/-0^{\circ}\text{C}$</td> </tr> </tbody> </table> Refer to JIS-C5201-1 4.19	Testing Condition		Lowest Temperature	$-55 +0/-10^{\circ}\text{C}$	Highest Temperature	$150 +10/-0^{\circ}\text{C}$	$\leq \pm 1.0\%$ No evidence of mechanical damage
Testing Condition								
Lowest Temperature	$-55 +0/-10^{\circ}\text{C}$							
Highest Temperature	$150 +10/-0^{\circ}\text{C}$							
Moisture Resistance (Climatic Sequence)	Put the tested resistor in chamber and subject to 10 cycles of damp heat and without power. Each one of which consists of the steps 1 to 7 (Figure 1). Then leaving the tested resistor in room temperature for 24 hr, and measure its resistance variance rate. Refer to MIL-STD 202 Method 106	$\leq \pm 0.5\%$ No evidence of mechanical damage						
Bias Humidity	Put the tested resistor in chamber under $85\pm 5^{\circ}\text{C}$ and $85\pm 5\%RH$ with 10% bias and load the rated voltage for 90 minutes on, 30 minutes off, total 1,000 hours. Then leaving the tested resistor in room temperature for 60 minutes, and measure its resistance variance rate. Refer to JIS-C5201-1 4.24	$\leq \pm 1.0\%$ No evidence of mechanical damage						

5.4 Operational Life Endurance:

Test Item	Conditions of Test	Test Limits
Load Life	Put the tested resistor in chamber under temperature $70\pm 2^{\circ}\text{C}$ and load the rated voltage for 90 minutes on 30 minutes off, total 1000 hours. Then leaving the tested resistor in room temperature for 60 minutes, and measure its resistance variance rate. Refer to JIS-C5201-1 4.25	$\leq \pm 1.0\%$ No evidence of mechanical damage

Remark	IT'S NOT UNDER CONTROL FOR PDF FILE PLS NOTE THE VERSION STATED..	Issue Dep. DATA Center.
	Do not copy without permission	Series No. 60

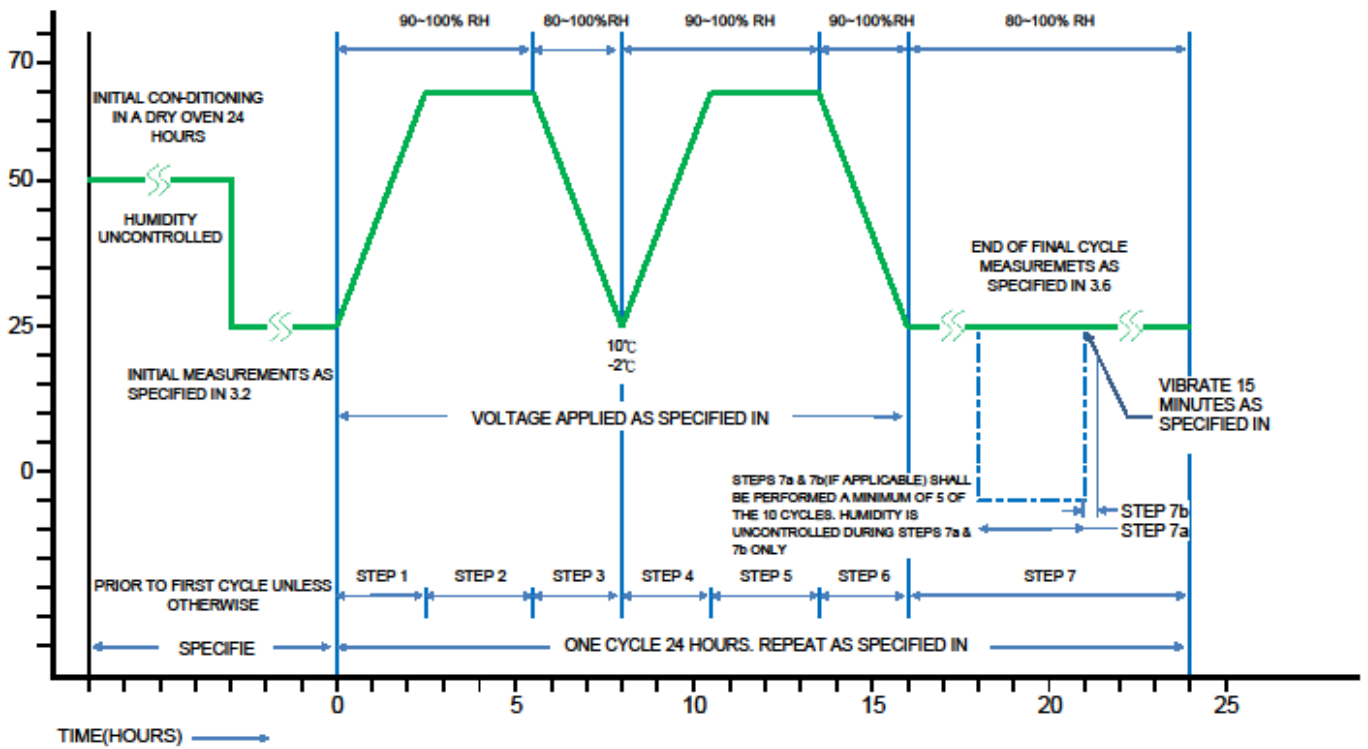

Remark

IT'S NOT UNDER CONTROL FOR PDF FILE
PLS NOTE THE VERSION STATED..

Issue Dep. DATA Center.

Do not copy without permission

Series No. **60**

6 Marking Format: (All the products marking are 4 digits)

6.1 LRE0402、LRE0603、LRE0805 No Marking.

6.2 LRE1206 series:

Product resistance is indicated by using two marking notation styles:

- a. "R" designates the decimal location in ohms, e.g.
 - For 1mΩ the product marking is R001;
 - For 25mΩ the product marking is R025;
- b. "m" designates the decimal location in milliohms, e.g.
 - For 0.25mΩ the product marking is 0m25;
 - For 0.5mΩ the product marking is 0m50;
 - For 5.5mΩ the product marking is 5m50;
 - For 25.5mΩ the product marking is 25m5.

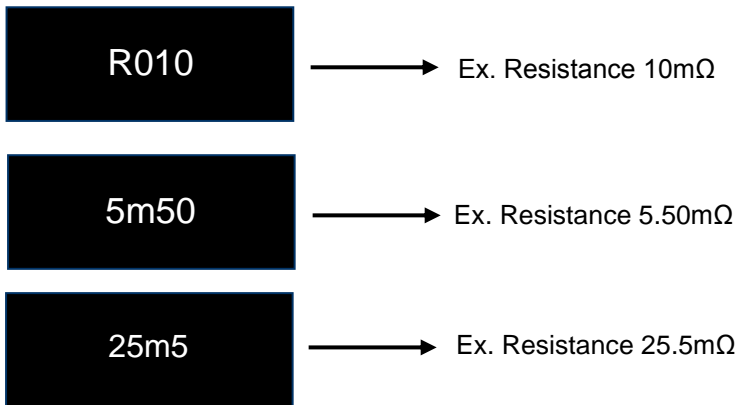

6.3 Marking Style by Laser:

Type	Marking												
	R	m	1	2	3	4	5	6	7	8	9	0	
1206	R	m	1	2	3	4	5	6	7	8	9	0	

《EX》 Marking→R005 = 5 mΩ



Remark

IT'S NOT UNDER CONTROL FOR PDF FILE
PLS NOTE THE VERSION STATED..

Issue Dep.**DATA Center.**

Do not copy without permission

Series No. **60**

7 Plating Thickness:

7.1 Ni : $\geq 2 \mu m$

7.2 Sn(Tin) : $\geq 3 \mu m$

7.3 Sn(Tin) : Matte Sn

8 Measurement Point:

Bottom electrode		Unit : mm	
TYPE	DIM	A	B
		LRE0402	0.65±0.05
LRE0603	1.25±0.05	0.30±0.05	
LRE0805	1.65±0.05	0.70±0.05	
LRE1206	2.70±0.05	0.40±0.05	

● Current Terminal
 ⊖ Voltage Terminal

9 Taping specifications:

9.1 Tape Dimensions:

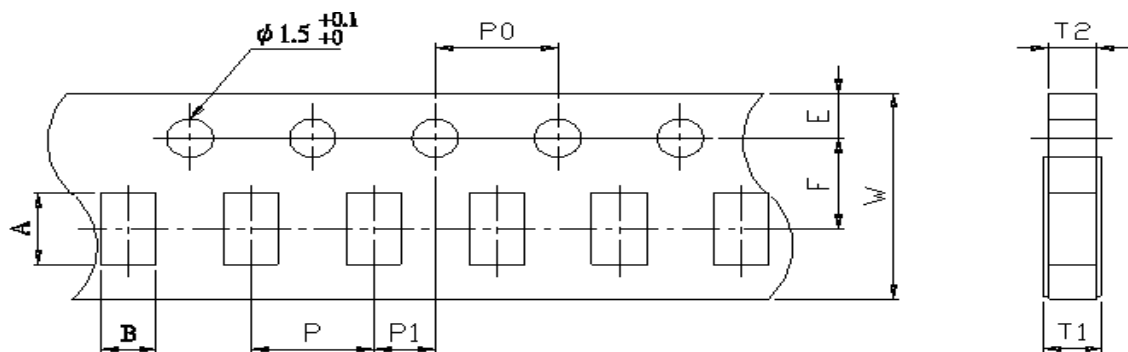

CARRIER TAPE

Unit: mm

DIM Item	A	B	W	E	F	T1	T2	P	P0	10*P0	P1
0402	1.15±0.05	0.65±0.05	8.00±0.20	1.75±0.10	3.50±0.05	0.40+0.2/-0	0.40±0.05	2.00±0.10	4.00±0.05	40.0±0.20	2.00±0.05
0603	1.80±0.10	1.00±0.10	8.00±0.20	1.75±0.10	3.50±0.05	0.40+0.2/-0	0.40±0.05	4.00±0.10	4.00±0.10	40.0±0.20	2.00±0.05
0805	2.30±0.10	1.55±0.10	8.00±0.20	1.75±0.10	3.50±0.05	0.40+0.2/-0	0.40±0.05	4.00±0.10	4.00±0.10	40.0±0.20	2.00±0.05
1206	3.50±0.20	1.90±0.20	8.00±0.20	1.75±0.10	3.50±0.05	0.60+0.2/-0	0.60±0.05	4.00±0.10	4.00±0.10	40.0±0.20	2.00±0.05

Remark

IT'S NOT UNDER CONTROL FOR PDF FILE
PLS NOTE THE VERSION STATED..

Issue Dep. DATA Center.

Do not copy without permission

Series No. **60**

9.2 Packaging model:

Type	Tape width	Max. Packaging Quantity (pcs/reel)	
		2 mm pitch	4 mm pitch
0402	8 mm	10,000pcs	--
0603	8 mm	--	5,000pcs
0805	8 mm	--	5,000pcs
1206	8 mm	--	5,000pcs

9.3 Reel Dimensions:

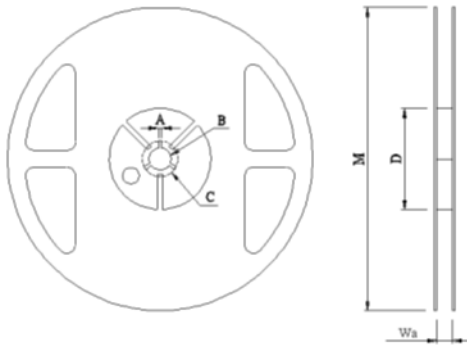

Unit: mm

Reel Type / Tape	W	M	A	B	C	D
7" reel for 8 mm tape	12.00± 0.5	178 ± 1.0	2.0 ± 0.5	13.2 ± 0.5	17.7 ± 0.5	60.0 ± 1.0

Remark

IT'S NOT UNDER CONTROL FOR PDF FILE
PLS NOTE THE VERSION STATED..

Issue Dep.**DATA Center.**

Do not copy without permission

Series No. **60**

10 Technical application notes: (This is for recommendation, please customer perform adjustment according to actual application)

10.1 Recommend soldering method:

10.1.1 This product is applicable to IR-reflow process only.(Infrared Reflow)

10.1.2 Typical examples of soldering processes that provides reliable joints without any damage are given in below:

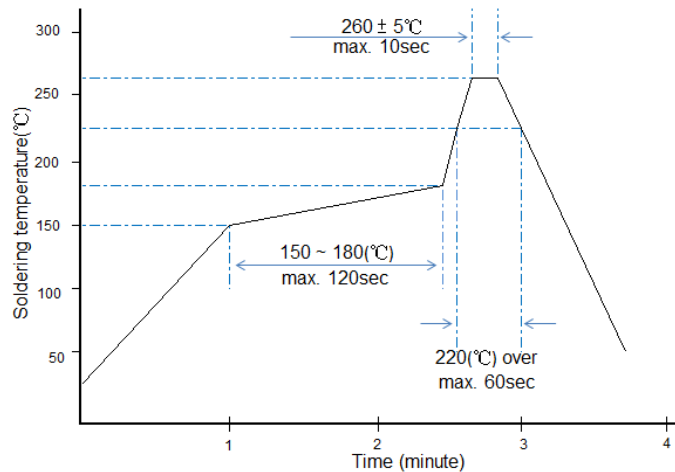

Recommended IR Reflow Soldering Profile
MEET J-STD-020D

10.1.3 Soldering Iron: temperature $350^{\circ}\text{C} \pm 10^{\circ}\text{C}$, dwell time shall be less than 3 sec.

Remark

IT'S NOT UNDER CONTROL FOR PDF FILE
PLS NOTE THE VERSION STATED..

Issue Dep. DATA Center.

Do not copy without permission

Series No. **60**

10.2 Recommend Land Pattern:

When a component is soldered, the resistance after soldering changes slightly depending on the size of the soldering area and the amount of soldering. When designing a circuit, it is necessary to consider the effect of a decrease or increase in its resistance.

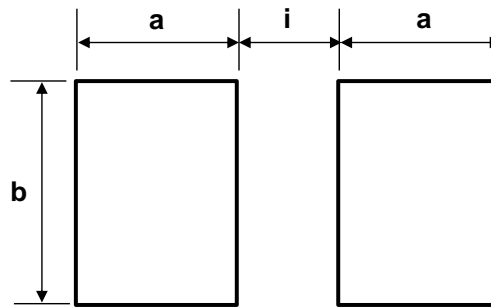

Type	Power Rating (Watts)	Resistance Range (mΩ)	Dimensions - millimeters		
			a	b	i
0402	1/6 & 1/5	1.5~5、10	0.65	0.50	0.50
	1/4	3~5、10	0.65	0.50	0.50
0603	1/3	1~60	1.00	1.27	0.50
	1/2	2~15	1.00	1.27	0.50
0805	1/2	2~70	1.45	1.78	0.66
	3/4	2~10	1.45	1.78	0.66
1206	1/2 & 1.0	$1 \leq R < 3$	1.65	2.18	0.60
		$3 \leq R < 4$			0.90
		$4 \leq R \leq 75$			1.00

Remark

IT'S NOT UNDER CONTROL FOR PDF FILE
PLS NOTE THE VERSION STATED..

Issue Dep.**DATA Center.**

Do not copy without permission

Series No. **60**

RALEC 旺詮	LRE Series Metal Alloy Low-Resistance Resistor Product Specifications	Document No.	IE-SP-074
		Released Date	2019/09/23
		Page No.	13

10.3 Environment Precautions:

This specification product is for general electronic use, RALEC will not be responsible for any damage, cost or loss caused by using this specification product in any special environment. If other applications need to confirm with RALEC.

If consumer intends to use our Company product in special environment or condition (including but not limited to those mentioned below), then will need to make individual recognition of product features and reliability accordingly.

- (a) Used in high temperature and humidity environment
 - (b) Exposed to sea breeze or other corrosive gas, such as Cl₂ · H₂S · NH₃ · SO₂ and NO₂.
 - (c) Used in non-verified liquids including water, oil, chemical and organic solvents.
 - (d) Using non-verified resin or other coating material to seal or coat our Company product.
- After soldering, it is necessary to use water-soluble detergents to clean residual solder fluxes, even though no-clean fluxes are recommended.

10.4 Momentary Overload Precautions:

The product might be out of function when momentary overloaded. Please make sure to avoid momentary overloading while using and preserving.

10.5 Operation and Processing Precautions:

- (a) Avoid damage to the edge of resistor and protective layer caused by mechanical stress.
- (b) Handle with care when printing circuit board (PCB) is divided or fixed on support body, because bending of printing circuit board (PCB) mounting will make mechanical stress for resistors.
- (c) Make sure the power rating is under the limit when using the resistor. When power rating is over the limit, the resistor will be overloaded. There might be machinery damage due to the climbing temperature.
- (d) If the resistor will be exposed under massive impact load (shock wave) in a short period of time, the working environment must be set up well before use.
- (e) Please make evaluation and confirmation when the product is well used in your company and have a through consideration of it's fail-safe design to ensure the system safety.

Remark	IT'S NOT UNDER CONTROL FOR PDF FILE PLS NOTE THE VERSION STATED..	Issue Dep. DATA Center.
	Do not copy without permission	Series No. 60

RALEC 旺詮	LRE Series Metal Alloy Low-Resistance Resistor Product Specifications	Document No.	IE-SP-074
		Released Date	2019/09/23
		Page No.	14

11 Storage and transportation requirement:

- 11.1 The temperature condition must be controlled at $25\pm 5^{\circ}\text{C}$, the R.H. must be controlled at $60\pm 15\%$. The stock can maintain quality level in two years.
- 11.2 Please avoid the mentioned harsh environment below when storing to ensure product performance and its' weldability. Places exposed to sea breeze or other corrosive gas, such as Cl_2 、 H_2S 、 NH_3 、 SO_2 and NO_2 .
- 11.3 When the product is moved and stored, please ensure the correct orientation of the box. Do not drop or squeeze the box. Otherwise, the electrode or the body of the product may be damaged.

12 Attachments:

- 12.1 Document Revise Record (QA-QR-027)

Remark	IT'S NOT UNDER CONTROL FOR PDF FILE PLS NOTE THE VERSION STATED..	Issue Dep. DATA Center.
	Do not copy without permission	

RALEC 旺詮	LRE Series Metal Alloy Low-Resistance Resistor Product Specifications	Document No.	IE-SP-074
		Released Date	2019/09/23
		Page No.	15

Legal disclaimer

RALEC, its distributors and agents (collectively, "RALEC"), hereby disclaims any and all liabilities for any errors, inaccuracies or incompleteness contained in any product related information, including but not limited to product specifications, datasheets, pictures and/or graphics. RALEC may make changes, modifications and/or improvements to product related information at any time and without notice.

RALEC makes no representation, warranty, and/or guarantee about the fitness of its products for any particular purpose or the continuing production of any of its products. To the maximum extent permitted by law, RALEC disclaims (i) any and all liability arising out of the application or use of any RALEC product, (ii) any and all liability, including without limitation special, consequential or incidental damages, and (iii) any and all implied warranties, including warranties of fitness for a particular purpose, non-infringement and merchantability.

RALEC defined this product is for general electrical use , not design for any application for automotive electrical ,life-saving or life support equipment, or any application which may inflict casualties if RALEC product failure occurred. When consumer is using or selling products of RALEC without having discussion with the sales representatives and specifically stated the applicability mentioned above in a written form, then the client need to take a full responsibility and agree to protect RALEC from punishment and damage.

Information provided here is intended to indicate product specifications only. RALEC reserves all the rights for revising this content without further notification, as long as products are unchanged. Any product change will be announced by ECN.

Remark	IT'S NOT UNDER CONTROL FOR PDF FILE PLS NOTE THE VERSION STATED..	Issue Dep. DATA Center.
	Do not copy without permission	Series No. 60

单击下面可查看定价，库存，交付和生命周期等信息

[>>RALEC\(旺诠\)](#)