

SMAF

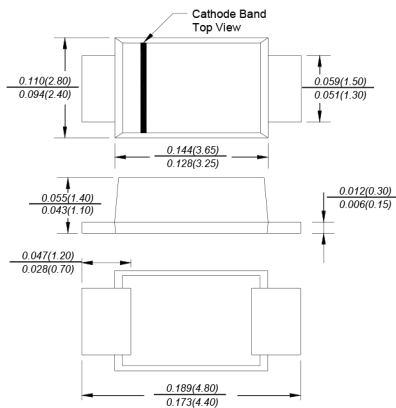

FEATURES

- ◆ The plastic package carries Underwriters Laboratory Flammability Classification 94V-0
- ◆ For surface mounted applications
- ◆ Metal silicon junction, majority carrier conduction
- ◆ Low power loss, high efficiency
- ◆ Built-in strain relief, ideal for automated placement
- ◆ High forward surge current capability
- ◆ High temperature soldering guaranteed: 260°C/10 seconds at terminals

MECHANICAL DATA

Case: JEDEC SMAF molded plastic body
Terminals: leads solderable per MIL-STD-750, Method 2026
Polarity: Color band denotes cathode end
Mounting Position: Any
Weight: 0.0018 ounce, 0.064 grams

MAXIMUM RATINGS AND ELECTRICAL CHARACTERISTICS

Ratings at 25°C ambient temperature unless otherwise specified.
 Single phase half-wave 60Hz, resistive or inductive load, for capacitive load current derate by 20%.

YXW Catalog Number	SYMBOLS	SS12F	SS13F	SS14F	SS15F	SS16F	SS18F	SS110F	SS1150F	SS1200F	UNITS	
Maximum repetitive peak reverse voltage	V_{RRM}	20	30	40	50	60	80	100	150	200	VOLTS	
Maximum RMS voltage	V_{RMS}	14	21	28	35	42	56	70	105	140	VOLTS	
Maximum DC blocking voltage	V_{DC}	20	30	40	50	60	80	100	150	200	VOLTS	
Maximum average forward rectified current at T_L (see fig.1)	$I_{(AV)}$	1.0									Amp	
Peak forward surge current 8.3ms single half sine-wave superimposed on rated load (JEDEC Method)	I_{FSM}	30.0									Amps	
Maximum instantaneous forward voltage at 1.0A	V_F	0.55		0.70			0.85		0.95		Volts	
Maximum DC reverse current at rated DC blocking voltage	I_R	0.5						0.2			mA	
$T_A=25^\circ C$ $T_A=100^\circ C$		10.0				5.0		2.0				
Typical junction capacitance (NOTE 1)	C_J	110				90					pF	
Typical thermal resistance (NOTE 2)	$R_{\theta JA}$	88.0										$^\circ C/W$
Operating junction temperature range	T_J	-50 to +125					-50 to +150					$^\circ C$
Storage temperature range	T_{STG}	-50 to +150										$^\circ C$

Note: 1. Measured at 1MHz and applied reverse voltage of 4.0V D.C.
 2. P.C.B. mounted with 0.2x0.2" (5.0x5.0mm) copper pad areas

RATINGS AND CHARACTERISTIC CURVES SS12F THRU SS1200F

AVERAGE FORWARD RECTIFIED CURRENT,
AMPERES

FIG. 1- FORWARD CURRENT DERATING CURVE

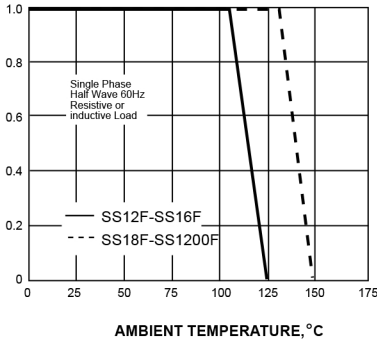

PEAK FORWARD SURGE CURRENT,
AMPERES

FIG. 2-MAXIMUM NON-REPETITIVE PEAK FORWARD SURGE CURRENT

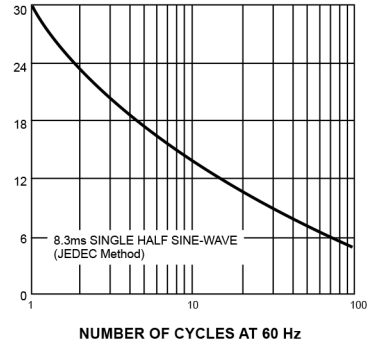

INSTANTANEOUS FORWARD CURRENT, AMPERES

FIG. 3-TYPICAL INSTANTANEOUS FORWARD CHARACTERISTICS

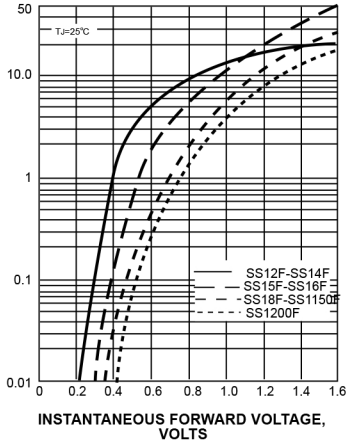

INSTANTANEOUS REVERSE CURRENT,
MILLIAMPERES

FIG. 4-TYPICAL REVERSE CHARACTERISTICS

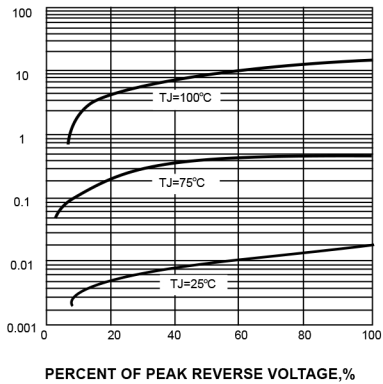

JUNCTION CAPACITANCE, pF

FIG. 5-TYPICAL JUNCTION CAPACITANCE

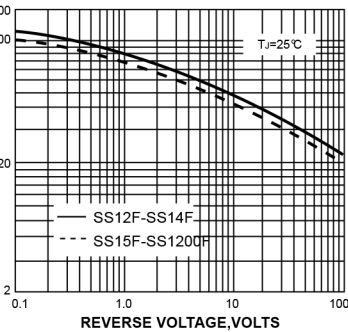

TRANSIENT THERMAL IMPEDANCE,
°C/W

FIG. 6-TYPICAL TRANSIENT THERMAL IMPEDANCE

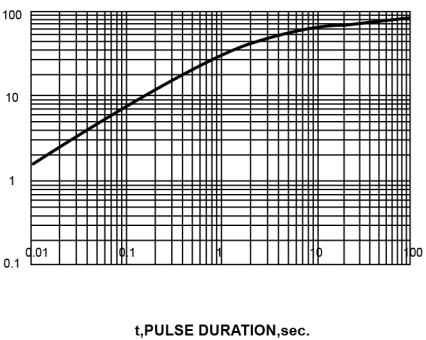

单击下面可查看定价，库存，交付和生命周期等信息

[>>RCD\(达标电子\)](#)