

Product Summary

$V_{(BR)DSS}$	$R_{DS(on)MAX}$	I_D
-30V	65mΩ@-10V	-4.2A
	75mΩ@-4.5V	
	90mΩ@-2.5V	

Feature

- TrenchFET Power MOSFET
- Exceptional on-resistance and maximum DC current capability

Application

- DC/DC Converter
- Load Switch for Portable Devices
- Battery Switch

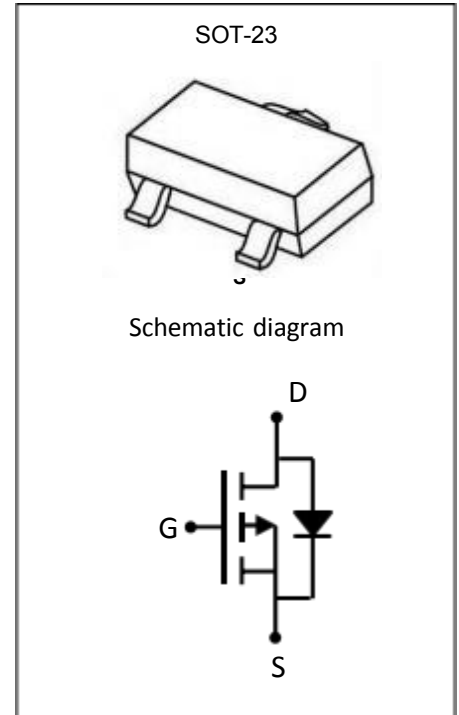
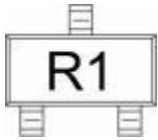
MARKING:

ABSOLUTE MAXIMUM RATINGS ($T_a=25^{\circ}\text{C}$ unless otherwise noted)

Parameter	Symbol	Value	Unit
Drain-Source Voltage	V_{DS}	-30	V
Gate-Source Voltage	V_{GS}	±12	V
Continuous Drain Current	I_D	-4.2	A
Power Dissipation	P_D	0.35	W
Thermal Resistance from Junction to Ambient	$R_{\theta JA}$	357	$^{\circ}\text{C}/\text{W}$
Junction Temperature	T_J	150	$^{\circ}\text{C}$
Storage Temperature	T_{STG}	-55~ +150	$^{\circ}\text{C}$

MOSFET ELECTRICAL CHARACTERISTICS($T_a=25^{\circ}\text{C}$ unless otherwise noted)

Parameter	Symbol	Test Condition	Min	Type	Max	Unit
Static Characteristics						
Drain-source breakdown voltage	$V_{(BR)DSS}$	$V_{GS} = 0V, I_D = -250\mu A$	-30			V
Zero gate voltage drain current	I_{DSS}	$V_{DS} = -24V, V_{GS} = 0V$			-1	μA
Gate-body leakage current	I_{GSS}	$V_{GS} = \pm 12V, V_{DS} = 0V$			± 100	nA
Gate threshold voltage	$V_{GS(th)}$	$V_{DS} = V_{GS}, I_D = -250\mu A$	-0.7	-0.9	-1.3	V
Drain-source on-resistance ⁽¹⁾	$R_{DS(on)}$	$V_{GS} = -10V, I_D = -4.2A$		50	65	m Ω
		$V_{GS} = -4.5V, I_D = -4A$		60	75	
		$V_{GS} = -2.5V, I_D = -1A$		70	90	
Forward transconductance ⁽¹⁾	g_{FS}	$V_{DS} = -5V, I_D = -4.2A$		10		S
Dynamic characteristics⁽²⁾						
Input Capacitance	C_{iss}	$V_{DS} = -15V, V_{GS} = 0V, f = 1MHz$		954		pF
Output Capacitance	C_{oss}			115		
Reverse Transfer Capacitance	C_{rss}			77		
Switching characteristics⁽²⁾						
Turn-on delay time	$t_{d(on)}$	$V_{GS} = -10V, V_{DS} = -15V,$ $R_L = 3.6\Omega, R_{GEN} = 6\Omega$			6.3	ns
Turn-on rise time	t_r				3.2	
Turn-off delay time	$t_{d(off)}$				38.2	
Turn-off fall time	t_f				12	
Source-Drain Diode characteristics						
Diode forward current	I_S				-2	A
Diode pulsed forward current	I_{SM}				-25	A
Diode Forward voltage ⁽¹⁾	V_{DS}	$V_{GS} = 0V, I_S = -4.2A$			-1.2	V

Notes:

1. Pulse test; pulse width $\leq 300\mu s$, duty cycle $\leq 2\%$.
2. Guaranteed by design, not subject to production testing.

Typical Electrical and Thermal Characteristics

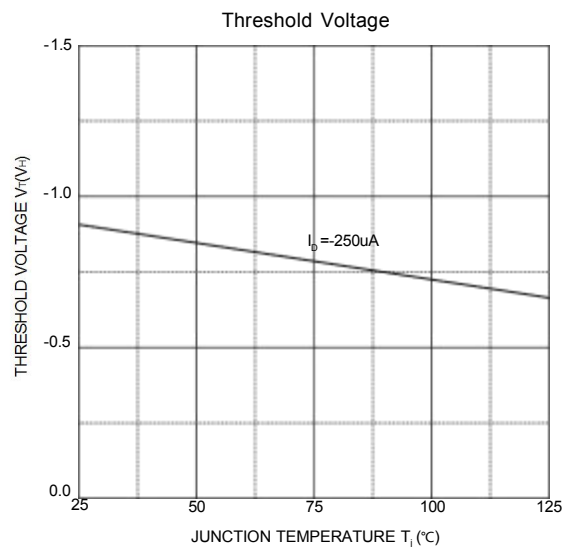
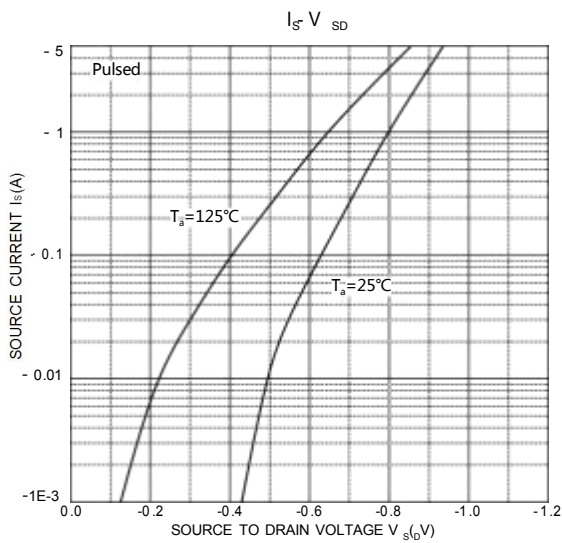
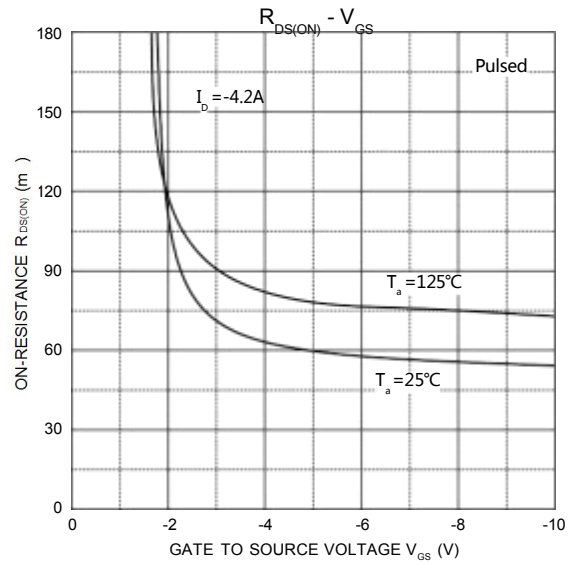
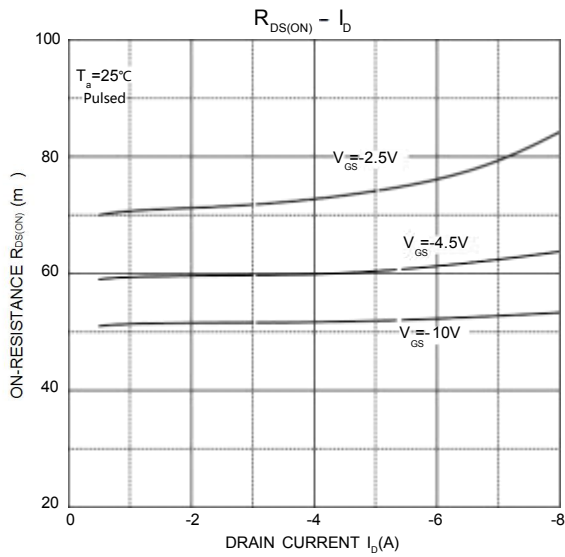
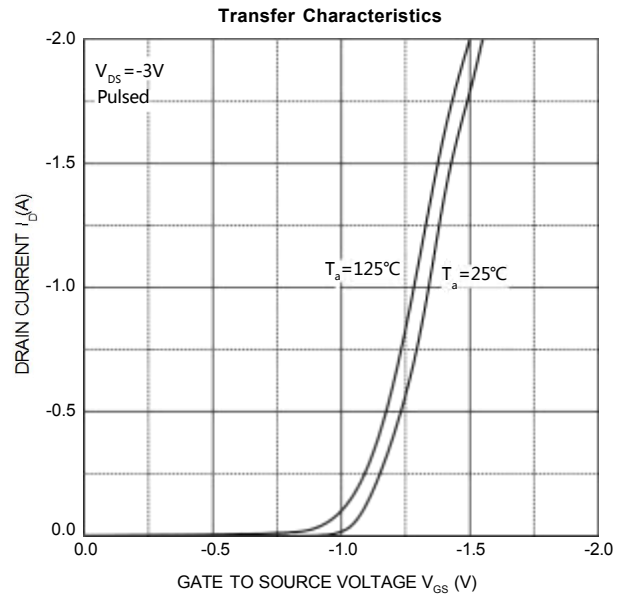
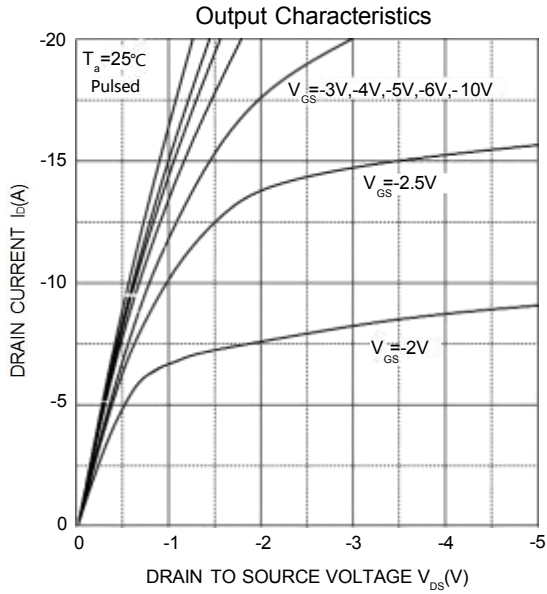

SOT-23 Package Information

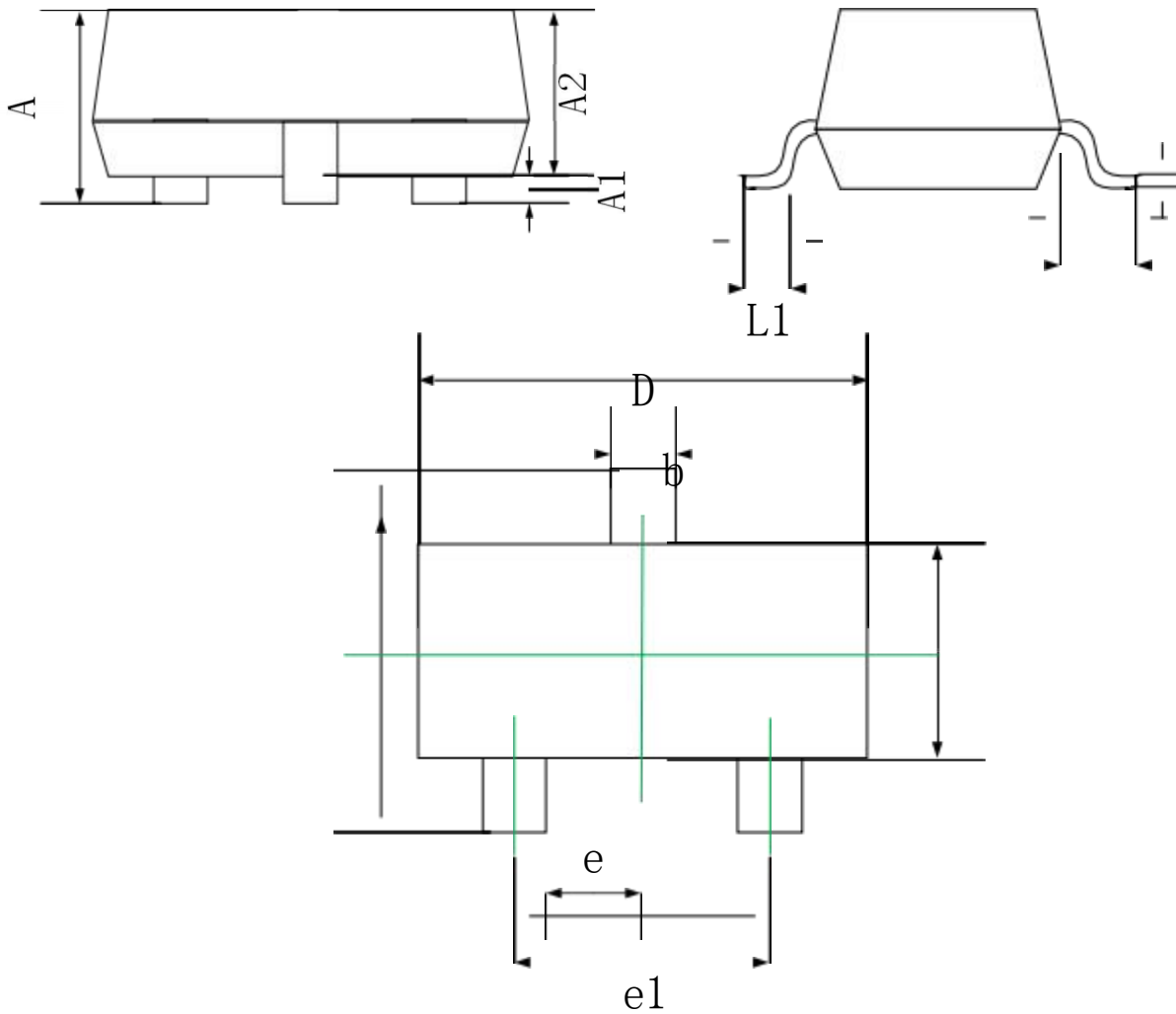

Symbol	Dimensions In Millimeters	
	Min.	Max.
A	0.90	1.15
A1	0.00	0.10
A2	0.90	1.05
b	0.30	0.50
c	0.08	0.15
D	2.80	3.00
E	1.20	1.40
E1	2.25	2.55
e	0.95 REF.	
e1	1.80	2.00
L	0.55 REF.	
L1	0.30	0.50

SOT-23 Tape and Reel

SOT-23 Tape and reel

SOT-23 Embossed Carrier Tape

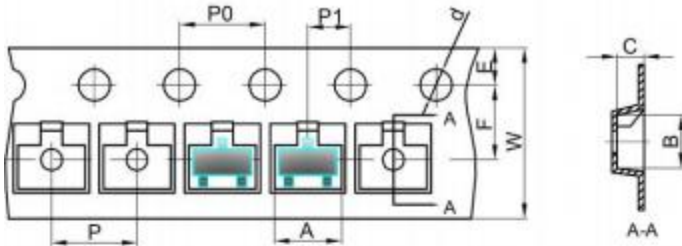

Dimensions are in millimeter										
Pkg type	A	B	C	d	E	F	P0	P	P1	W
SOT-23	3.15	2.77	1.22	Ø1.50	1.75	3.50	4.00	4.00	2.00	8.00

SOT-23 Tape Leader and Trailer

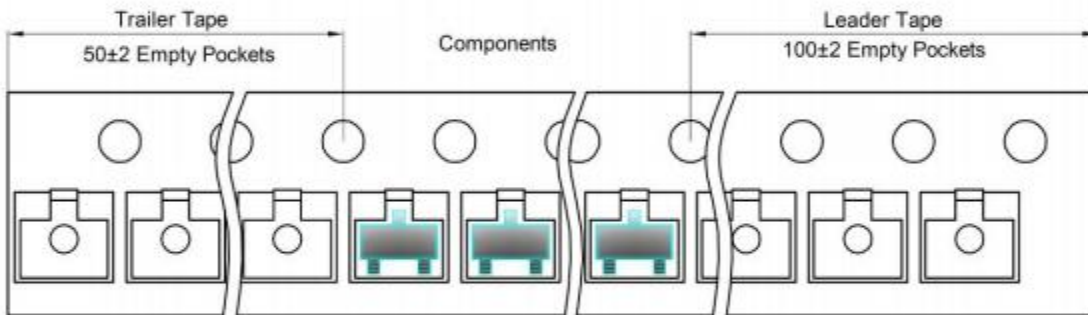

SOT-23 Reel

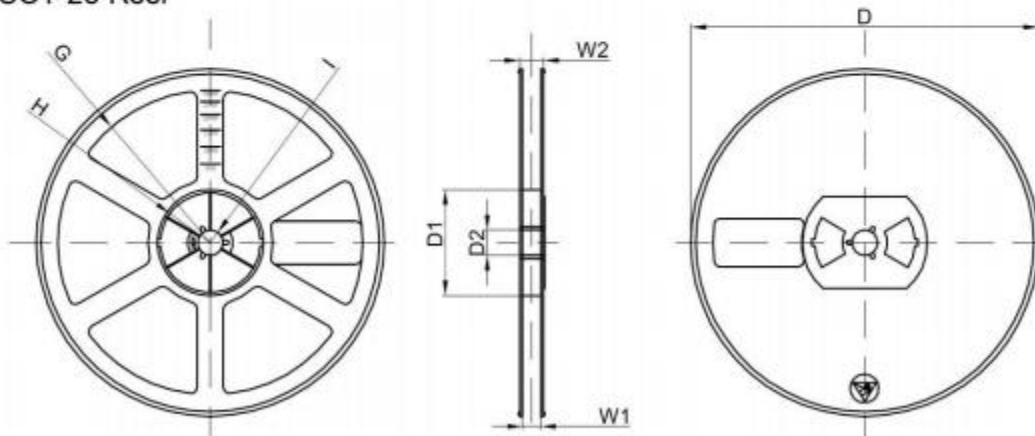

Dimensions are in millimeter								
Reel Option	D	D1	D2	G	H	I	W1	W2
7" Dia	Ø178.00	54.40	13.00	R78.00	R25.60	R6.50	9.50	12.30

REEL	Reel Size	Box	Box Size(mm)	Carton	Carton Size(mm)	G.W.(kg)
3000 pcs	7 inch	30,000 pcs	203×203×195	120,000 pcs	438×438×220	

Disclaimers:

Reasunos Semiconductor Technology CO.,LTD(Reasunos)reserves the right to make changes without notice in order to improve reliability,function or design and to discontinue any product or service without notice .Customers should obtain the latest relevant information before orders and should verify that such information in current and complete.All products are sold subject to Reasunos's terms and conditions supplied at the time of order acknowledgement.

Reasunos Semiconductor Technology CO.,LTD warrants performance of its hardware products to the specifications at the time of sale.Testing, reliability and quality control are used to the extene Reasunos deems necessary to support this warrantee. Except where agreed upon by contractual agreement,testing of all parameters of each product is not necessarily performed.

Reasunos Semiconductor Technology CO.,LTD does not assume any liability arising from the use of any product or circuit designs described herein.Customers are responsible for their products and applications using Reasunos's components.To minimize risk,customers must provide adequate design and operating safeguards.

Reasunos Semiconductor Technology CO.,LTD does not warrant or convey any license either expressed or implied under its patent rights,nor the rights of others.Reproduction of information in Reasunos's data sheets or data books is permissible only if reproduction is without modification oralteration.Reproduction of this information with any alteration is an unfair and deceptive business practice. Reasunos Semiconductor Technology CO.,LTD is not responsible or liable for such altered documentation.

Resale of Reasunos's products with statements different from or beyond the parameters stated by Reasunos Semiconductor Technology CO.,LTD for that product or service voids all express or implied warranties for the associated Reasunos's product or service and is unfair and deceptive business practice. Reasunos Semiconductor Technology CO.,LTD is not responsible or liable for such statements.

Life Support Policy:

Reasunos Semiconductor Technology CO.,LTD's Products are not authorized for use as critical components in life support devices or systems without the expressed written approval of Reasunos Semiconductor Technology CO.,LTD.

As used herein:

- 1.Life support devices or systems are devices or systems which:
 - a.are intended for surgical implant into the human body,
 - b.support or sustain life,
 - c.whose failuer to when properly used in accordance with instructions for used provided in the laeling,can be reasonably expected to result in significant injury to the user.

- 2.A critical component is any component of a life support device or system whose failure to system whose failure to perform can be reasonably expected to cause the failure of the life support device or system,or to affect its safety or effectiveness.

单击下面可查看定价，库存，交付和生命周期等信息

[>>REASUNOS\(瑞森\)](#)