

ISL21010

Micropower Voltage Reference

FN7896  
Rev.7.00  
Sep 20, 2021

The **ISL21010** is a precision, low dropout micropower bandgap voltage reference in a space-saving SOT-23 package. It operates from a single 2.2V to 5.5V supply (minimum voltage is dependent on voltage option) and provides a  $\pm 0.2\%$  accurate reference. The ISL21010 provides up to 25mA output current sourcing with low 150mV dropout voltage.

Output voltage options include 1.024V, 1.2V, 1.5V, 2.048V, 2.5V, 3.0V, 3.3V, and 4.096V. The low supply current and low dropout voltage combined with high accuracy make the ISL21010 ideal for precision battery powered applications.

**Applications**

- Battery management/monitoring
- Low power standby voltages
- Portable instrumentation
- Consumer/medical electronics
- Lower cost industrial and instrumentation
- Power regulation circuits
- Control loops and compensation networks
- LED/diode supply

**Features**

- Reference output voltages ..... 1.024V, 1.25V, 1.5V, 2.048V, 2.5V, 3.0V, 3.3V, 4.096V
- Precision 0.2% initial accuracy
- Input voltage range:
  - ISL21010-10, -12, -15 -20 ..... 2.2V to 5.5V
  - ISL21010-25 ..... 2.6V to 5.5V
  - ISL21010-30 ..... 3.1V to 5.5V
  - ISL21010-33 ..... 3.4V to 5.5V
  - ISL21010-41 ..... 4.2V to 5.5V
- Output current source capability ..... 25mA
- Operating temperature range. .... -40°C to +125°C
- Output voltage noise ( $V_{OUT} = 2.048V$ ) ..... 58 $\mu V_{P-P}$  (0.1Hz to 10Hz)
- Supply current ..... 48 $\mu A$  (typical)
- Tempco ..... 50ppm/°C
- Package ..... 3 Ld SOT-23
- Pb-free (RoHS compliant)

**Related Literature**

For a full list of related documents, visit our website:

- [ISL21010DFH310](#), [ISL21010DFH312](#), [ISL21010CFH315](#), [ISL21010CFH320](#), [ISL21010CFH325](#), [ISL21010CFH330](#), [ISL21010CFH333](#), and [ISL21010CFH341](#) device pages

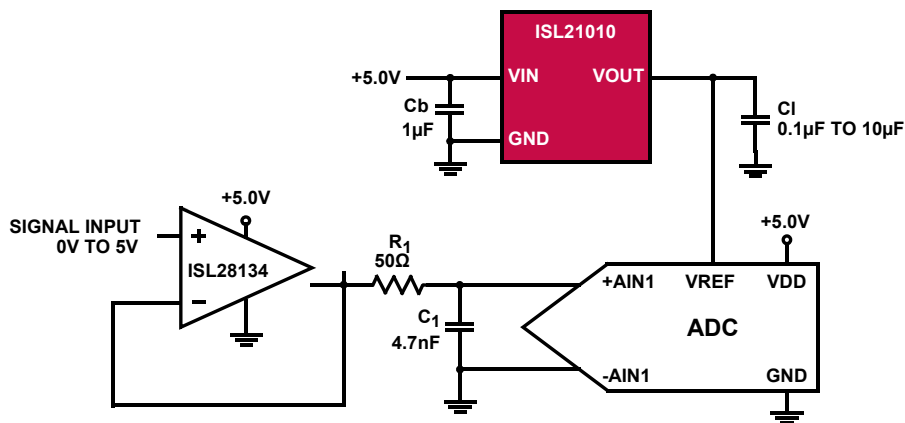

FIGURE 1. TYPICAL APPLICATION DIAGRAM

## Table of Contents

<b>Typical Application Circuit</b> .....	<b>3</b>
<b>Pin Configuration</b> .....	<b>3</b>
<b>Pin Descriptions</b> .....	<b>3</b>
<b>Ordering Information</b> .....	<b>4</b>
<b>Absolute Maximum Ratings</b> .....	<b>5</b>
<b>Thermal Information</b> .....	<b>5</b>
<b>Recommended Operating Conditions</b> .....	<b>5</b>
<b>Electrical Specifications (ISL21010-10, <math>V_{OUT} = 1.024V</math>)</b> .....	<b>5</b>
<b>Electrical Specifications (ISL21010-12, <math>V_{OUT} = 1.25V</math>)</b> .....	<b>6</b>
<b>Electrical Specifications (ISL21010-15, <math>V_{OUT} = 1.5V</math>)</b> .....	<b>6</b>
<b>Electrical Specifications (ISL21010-20, <math>V_{OUT} = 2.048V</math>)</b> .....	<b>7</b>
<b>Electrical Specifications (ISL21010-25, <math>V_{OUT} = 2.5V</math>)</b> .....	<b>7</b>
<b>Electrical Specifications (ISL21010-30, <math>V_{OUT} = 3.0V</math>)</b> .....	<b>8</b>
<b>Electrical Specifications (ISL21010-33, <math>V_{OUT} = 3.3V</math>)</b> .....	<b>8</b>
<b>Electrical Specifications (ISL21010-41, <math>V_{OUT} = 4.096V</math>)</b> .....	<b>9</b>
<b>Typical Performance Characteristics Curves (<math>V_{OUT} = 1.024V</math>)</b> .....	<b>10</b>
<b>Typical Performance Characteristics Curves (<math>V_{OUT} = 1.25V</math>)</b> .....	<b>13</b>
<b>Typical Performance Characteristics Curves (<math>V_{OUT} = 1.5V</math>)</b> .....	<b>16</b>
<b>Typical Performance Characteristics Curves (<math>V_{OUT} = 2.048V</math>)</b> .....	<b>19</b>
<b>Typical Performance Characteristics Curves (<math>V_{OUT} = 2.5V</math>)</b> .....	<b>22</b>
<b>Typical Performance Characteristics Curves (<math>V_{OUT} = 3.0V</math>)</b> .....	<b>25</b>
<b>Typical Performance Characteristics Curves (<math>V_{OUT} = 3.3V</math>)</b> .....	<b>28</b>
<b>Typical Performance Characteristics Curves (<math>V_{OUT} = 4.096V</math>)</b> .....	<b>31</b>
<b>Applications Information</b> .....	<b>34</b>
Micropower Operation .....	34
Board Mounting Considerations .....	34
Board Assembly Considerations .....	34
Noise Performance and Reduction .....	34
<b>Revision History</b> .....	<b>35</b>
<b>Package Outline Drawing</b> .....	<b>36</b>

## Typical Application Circuit



FIGURE 2. KELVIN SENSED LOAD

## Pin Configuration

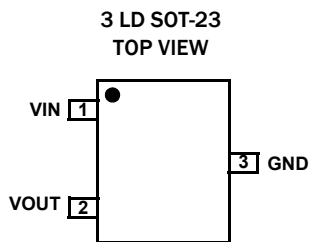

## Pin Descriptions

PIN NUMBER	PIN NAME	DESCRIPTION
1	VIN	Input voltage connection
2	VOUT	Voltage reference output
3	GND	Ground connection

## Ordering Information

PART NUMBER (Notes 2, 3, 4)	PART MARKING	V <sub>OUT</sub> OPTION (V)	INITIAL ACCURACY (%)	PACKAGE (RoHS Compliant)	PKG. DWG. #	Carrier Type (Note 1)	TEMP. RANGE
ISL21010DFH310Z-T	BEBA	1.024	±0.2	3 Ld SOT-23	P3.064	Reel, 3k	-40 to +125° C
ISL21010DFH310Z-TK						Reel, 1k	
ISL21010DFH310Z-T7A						Reel, 250	
ISL21010DFH312Z-T	BECA	1.25				Reel, 3k	
ISL21010DFH312Z-TK						Reel, 1k	
ISL21010DFH312Z-T7A						Reel, 250	
ISL21010CFH315Z-TK	BDRA	1.5				Reel, 1k	
ISL21010CFH315Z-T7A						Reel, 250	
ISL21010CFH320Z-TK	BDSA	2.048				Reel, 1k	
ISL21010CFH320Z-T7A						Reel, 250	
ISL21010CFH325Z-TK	BDTA	2.5				Reel, 1k	
ISL21010CFH325Z-T7A						Reel, 250	
ISL21010CFH330Z-TK	BDVA	3.0				Reel, 1k	
ISL21010CFH330Z-T7A						Reel, 250	
ISL21010CFH333Z-TK	BDWA	3.3				Reel, 1k	
ISL21010CFH333Z-T7A						Reel, 250	
ISL21010CFH341Z-TK	BDYA	4.096				Reel, 1k	
ISL21010CFH341Z-T7A						Reel, 250	
ISL2101010EV1Z	ISL21010DFH310Z Evaluation Board						
ISL2101012EV1Z	ISL21010DFH312Z Evaluation Board						
ISL2101015EV1Z	ISL21010CFH315Z Evaluation Board						

### NOTES:

- See [TB347](#) for details about reel specifications.
- These Pb-free plastic packaged products employ special Pb-free material sets, molding compounds/die attach materials, and 100% matte tin plate plus anneal (e3 termination finish, which is RoHS compliant and compatible with both SnPb and Pb-free soldering operations). Pb-free products are MSL classified at Pb-free peak reflow temperatures that meet or exceed the Pb-free requirements of IPC/JEDEC J STD-020.
- For Moisture Sensitivity Level (MSL), see the [ISL21010DFH310](#), [ISL21010DFH312](#), [ISL21010CFH315](#), [ISL21010CFH320](#), [ISL21010CFH325](#), [ISL21010CFH330](#), [ISL21010CFH333](#), [ISL21010CFH341](#) device pages. For more information about MSL, see [TB363](#).
- The part marking is located on the bottom of the part.

## Absolute Maximum Ratings

Max Voltage	
$V_{IN}$ to GND	-0.5V to +6.5V
$V_{OUT}$ (pin) to GND (10s)	-0.5V to $V_{IN} + 0.5V$
Input Voltage Slew Rate (Max)	1V/ $\mu$ s
Temperature Range (Industrial)	-40°C to +125°C
ESD Rating	
Human Body Model	5.5kV
Machine Model	300V
Charged Device Model	2kV

## Thermal Information

Thermal Resistance (Typical)	$\theta_{JA}$ (°C/W)	$\theta_{JC}$ (°C/W)
3 Ld SOT-23 Package (Notes 5, 6)	275	110
Continuous Power Dissipation ( $T_A = +125^\circ\text{C}$ )	99mW	
Storage Temperature Range	-65°C to +150°C	
Pb-Free Reflow Profile	see <a href="#">TB493</a>	

## Recommended Operating Conditions

Temperature	-40°C to +125°C
Supply Voltage	
$V_{OUT} = 1.024V, 1.25V, 1.5V, 2.048V$	2.2V to 5.5V
$V_{OUT} = 2.5V$	2.6V to 5.5V
$V_{OUT} = 3.0V$	3.1V to 5.5V
$V_{OUT} = 3.3V$	3.4V to 5.5V
$V_{OUT} = 4.096V$	4.2V to 5.5V

CAUTION: Do not operate at or near the maximum ratings listed for extended periods of time. Exposure to such conditions can adversely impact product reliability and result in failures not covered by warranty.

### NOTES:

- $\theta_{JA}$  is measured with the component mounted on a high-effective thermal conductivity test board in free air. See [TB379](#) for details.
- For  $\theta_{JC}$ , the "case temp" location is taken at the package top center.

**Electrical Specifications (ISL21010-10,  $V_{OUT} = 1.024V$ )**  $V_{IN} = 3.0V, T_A = +25^\circ\text{C}, I_{OUT} = 0A$ , unless otherwise specified. **Boldface limits apply across the operating temperature range, -40°C to +125°C.**

PARAMETER	SYMBOL	TEST CONDITIONS	MIN (Note 7)	TYP	MAX (Note 7)	UNIT
Output Voltage	$V_{OUT}$			1.024		V
$V_{OUT}$ Accuracy at $T_A = +25^\circ\text{C}$ (Note 11)	$V_{OA}$		-0.2		+0.2	%
Output Voltage Temperature Coefficient (Note 8)	TC $V_{OUT}$			15	<b>50</b>	ppm/°C
Input Voltage Range	$V_{IN}$		<b>2.2</b>		<b>5.5</b>	V
Supply Current	$I_{IN}$	$T_A = +25^\circ\text{C}$		46	80	$\mu$ A
		$T_A = -40^\circ\text{C}$ to $+125^\circ\text{C}$		60	<b>100</b>	$\mu$ A
Line Regulation	$\Delta V_{OUT} / \Delta V_{IN}$	$2.2V \leq V_{IN} \leq 5.5V$		5	<b>100</b>	$\mu$ V/V
Load Regulation	$\Delta V_{OUT} / \Delta I_{OUT}$	Sourcing: $0mA \leq I_{OUT} \leq 25mA$		15	<b>110</b>	$\mu$ V/mA
		Sinking: $-1mA \leq I_{OUT} \leq 0mA$		17		$\mu$ V/mA
Short-Circuit Current	$I_{SC}$	$T_A = +25^\circ\text{C}, V_{OUT}$ tied to GND		118		mA
Turn-On Settling Time	$t_R$	$V_{OUT} = \pm 0.1\%, C_{OUT} = 1\mu F$		300		$\mu$ s
Ripple Rejection		$f = 120\text{Hz}$		70		dB
Output Voltage Noise	$e_N$	$0.1\text{Hz} \leq f \leq 10\text{Hz}$		24		$\mu$ V <sub>p-p</sub>
Broadband Voltage Noise	$V_N$	$10\text{Hz} \leq f \leq 1\text{kHz}$		14		$\mu$ V <sub>RMS</sub>
Thermal Hysteresis (Note 10)	$\Delta V_{OUT} / \Delta T_A$	$\Delta T_A = +165^\circ\text{C}$		100		ppm
Long Term Stability	$\Delta V_{OUT} / \Delta t$	1000 hours, $T_A = +25^\circ\text{C}$		110		ppm

**Electrical Specifications (ISL21010-12,  $V_{OUT} = 1.25V$ )**  $V_{IN} = 3.0V$ ,  $T_A = +25^\circ C$ ,  $I_{OUT} = 0A$ , unless otherwise specified.  
**Boldface limits apply across the operating temperature range,  $-40^\circ C$  to  $+125^\circ C$ .**

PARAMETER	SYMBOL	TEST CONDITIONS	MIN (Note 7)	TYP	MAX (Note 7)	UNIT
Output Voltage	$V_{OUT}$			1.25		V
$V_{OUT}$ Accuracy at $T_A = +25^\circ C$ (Note 11)	$V_{OA}$		-0.2		+0.2	%
Output Voltage Temperature Coefficient (Note 8)	TC $V_{OUT}$			15	<b>50</b>	ppm/ $^\circ C$
Input Voltage Range	$V_{IN}$		<b>2.2</b>		<b>5.5</b>	V
Supply Current	$I_{IN}$	$T_A = +25^\circ C$		46	80	$\mu A$
		$T_A = -40^\circ C$ to $+125^\circ C$			<b>100</b>	$\mu A$
Line Regulation	$\Delta V_{OUT}/\Delta V_{IN}$	$2.2V \leq V_{IN} \leq 5.5V$		1	<b>100</b>	$\mu V/V$
Load Regulation	$\Delta V_{OUT}/\Delta I_{OUT}$	Sourcing: $0mA \leq I_{OUT} \leq 25mA$		35	<b>110</b>	$\mu V/mA$
		Sinking: $-1mA \leq I_{OUT} \leq 0mA$		50		$\mu V/mA$
Short-Circuit Current	$I_{SC}$	$T_A = +25^\circ C$ , $V_{OUT}$ tied to GND		118		mA
Turn-On Settling Time	$t_R$	$V_{OUT} = \pm 0.1\%$ , $C_{OUT} = 1\mu F$		300		$\mu s$
Ripple Rejection		$f = 120Hz$		68		dB
Output Voltage Noise	$e_N$	$0.1Hz \leq f \leq 10Hz$		27		$\mu V_{P-P}$
Broadband Voltage Noise	$V_N$	$10Hz \leq f \leq 1kHz$		17		$\mu V_{RMS}$
Thermal Hysteresis (Note 10)	$\Delta V_{OUT}/\Delta T_A$	$\Delta T_A = +165^\circ C$		100		ppm
Long Term Stability	$\Delta V_{OUT}/\Delta t$	1000 hours, $T_A = +25^\circ C$		110		ppm

**Electrical Specifications (ISL21010-15,  $V_{OUT} = 1.5V$ )**  $V_{IN} = 3.0V$ ,  $T_A = +25^\circ C$ ,  $I_{OUT} = 0A$ , unless otherwise specified.  
**Boldface limits apply across the operating temperature range,  $-40^\circ C$  to  $+125^\circ C$ .**

PARAMETER	SYMBOL	TEST CONDITIONS	MIN (Note 7)	TYP	MAX (Note 7)	UNIT
Output Voltage	$V_{OUT}$			1.5		V
$V_{OUT}$ Accuracy at $T_A = +25^\circ C$ (Note 11)	$V_{OA}$		-0.2		+0.2	%
Output Voltage Temperature Coefficient (Note 8)	TC $V_{OUT}$			15	<b>50</b>	ppm/ $^\circ C$
Input Voltage Range	$V_{IN}$		<b>2.2</b>		<b>5.5</b>	V
Supply Current	$I_{IN}$	$T_A = +25^\circ C$		46	80	$\mu A$
		$T_A = -40^\circ C$ to $+125^\circ C$			<b>100</b>	$\mu A$
Line Regulation	$\Delta V_{OUT}/\Delta V_{IN}$	$2.2V \leq V_{IN} \leq 5.5V$		9	<b>100</b>	$\mu V/V$
Load Regulation	$\Delta V_{OUT}/\Delta I_{OUT}$	Sourcing: $0mA \leq I_{OUT} \leq 25mA$		37	<b>110</b>	$\mu V/mA$
		Sinking: $-1mA \leq I_{OUT} \leq 0mA$		50		$\mu V/mA$
Short-Circuit Current	$I_{SC}$	$T_A = +25^\circ C$ , $V_{OUT}$ tied to GND		118		mA
Turn-On Settling Time	$t_R$	$V_{OUT} = \pm 0.1\%$ , $C_{OUT} = 1\mu F$		300		$\mu s$
Ripple Rejection		$f = 120Hz$		66		dB
Output Voltage Noise	$e_N$	$0.1Hz \leq f \leq 10Hz$		35		$\mu V_{P-P}$
Broadband Voltage Noise	$V_N$	$10Hz \leq f \leq 1kHz$		20		$\mu V_{RMS}$
Thermal Hysteresis (Note 10)	$\Delta V_{OUT}/\Delta T_A$	$\Delta T_A = +165^\circ C$		100		ppm
Long Term Stability	$\Delta V_{OUT}/\Delta t$	1000 hours, $T_A = +25^\circ C$		110		ppm

**Electrical Specifications (ISL21010-20,  $V_{OUT} = 2.048V$ )**  $V_{IN} = 3.0V$ ,  $T_A = +25^\circ C$ ,  $I_{OUT} = 0A$ , unless otherwise specified. **Boldface limits apply across the operating temperature range,  $-40^\circ C$  to  $+125^\circ C$ .**

PARAMETER	SYMBOL	TEST CONDITIONS	MIN (Note 7)	TYP	MAX (Note 7)	UNIT
Output Voltage	$V_{OUT}$			2.048		V
$V_{OUT}$ Accuracy at $T_A = +25^\circ C$ (Note 11)	$V_{OA}$		-0.2		+0.2	%
Output Voltage Temperature Coefficient (Note 8)	TC $V_{OUT}$			15	<b>50</b>	ppm/ $^\circ C$
Input Voltage Range	$V_{IN}$		<b>2.2</b>		<b>5.5</b>	V
Supply Current	$I_{IN}$	$T_A = +25^\circ C$		46	80	$\mu A$
		$T_A = -40^\circ C$ to $+125^\circ C$			<b>100</b>	$\mu A$
Line Regulation	$\Delta V_{OUT}/\Delta V_{IN}$	$2.2V \leq V_{IN} \leq 5.5V$		37	<b>130</b>	$\mu V/V$
Load Regulation	$\Delta V_{OUT}/\Delta I_{OUT}$	Sourcing: $0mA \leq I_{OUT} \leq 25mA$		18	<b>110</b>	$\mu V/mA$
		Sinking: $-1mA \leq I_{OUT} \leq 0mA$		10		$\mu V/mA$
Short-Circuit Current	$I_{SC}$	$T_A = +25^\circ C$ , $V_{OUT}$ tied to GND		118		mA
Turn-On Settling Time	$t_R$	$V_{OUT} = \pm 0.1\%$ , $C_{OUT} = 1\mu F$		300		$\mu s$
Ripple Rejection		$f = 120Hz$		66		dB
Output Voltage Noise	$e_N$	$0.1Hz \leq f \leq 10Hz$		58		$\mu V_{P-P}$
Broadband Voltage Noise	$V_N$	$10Hz \leq f \leq 1kHz$		26		$\mu V_{RMS}$
Thermal Hysteresis (Note 10)	$\Delta V_{OUT}/\Delta T_A$	$\Delta T_A = +165^\circ C$		100		ppm
Long Term Stability	$\Delta V_{OUT}/\Delta t$	1000 hours, $T_A = +25^\circ C$		50		ppm

**Electrical Specifications (ISL21010-25,  $V_{OUT} = 2.5V$ )**  $V_{IN} = 3.0V$ ,  $T_A = +25^\circ C$ ,  $I_{OUT} = 0A$ , unless otherwise specified. **Boldface limits apply across the operating temperature range,  $-40^\circ C$  to  $+125^\circ C$ .**

PARAMETER	SYMBOL	TEST CONDITIONS	MIN (Note 7)	TYP	MAX (Note 7)	UNIT
Output Voltage	$V_{OUT}$			2.5		V
$V_{OUT}$ Accuracy at $T_A = +25^\circ C$ (Note 11)	$V_{OA}$		-0.2		+0.2	%
Output Voltage Temperature Coefficient (Note 8)	TC $V_{OUT}$			15	<b>50</b>	ppm/ $^\circ C$
Input Voltage Range	$V_{IN}$		<b>2.6</b>		<b>5.5</b>	V
Supply Current	$I_{IN}$	$T_A = +25^\circ C$		46	80	$\mu A$
		$T_A = -40^\circ C$ to $+125^\circ C$			<b>100</b>	$\mu A$
Line Regulation	$\Delta V_{OUT}/\Delta V_{IN}$	$2.6V \leq V_{IN} \leq 5.5V$		62	<b>245</b>	$\mu V/V$
Load Regulation	$\Delta V_{OUT}/\Delta I_{OUT}$	Sourcing: $0mA \leq I_{OUT} \leq 25mA$		29	<b>110</b>	$\mu V/mA$
		Sinking: $-1mA \leq I_{OUT} \leq 0mA$		50		$\mu V/mA$
Dropout Voltage (Note 9)	$V_{INDO}$	$I_{OUT} = 10mA$		60	<b>150</b>	mV
Short-Circuit Current	$I_{SC}$	$T_A = +25^\circ C$ , $V_{OUT}$ tied to GND		118		mA
Turn-On Settling Time	$t_R$	$V_{OUT} = \pm 0.1\%$ , $C_{OUT} = 1\mu F$		300		$\mu s$
Ripple Rejection		$f = 120Hz$		62		dB
Output Voltage Noise	$e_N$	$0.1Hz \leq f \leq 10Hz$		67		$\mu V_{P-P}$
Broadband Voltage Noise	$V_N$	$10Hz \leq f \leq 1kHz$		37		$\mu V_{RMS}$
Thermal Hysteresis (Note 10)	$\Delta V_{OUT}/\Delta T_A$	$\Delta T_A = +165^\circ C$		100		ppm
Long Term Stability	$\Delta V_{OUT}/\Delta t$	1000 hours, $T_A = +25^\circ C$		110		ppm

**Electrical Specifications (ISL21010-30,  $V_{OUT} = 3.0V$ )**  $V_{IN} = 5.0V$ ,  $T_A = +25^\circ C$ ,  $I_{OUT} = 0A$ , unless otherwise specified.  
**Boldface limits apply across the operating temperature range,  $-40^\circ C$  to  $+125^\circ C$ .**

PARAMETER	SYMBOL	TEST CONDITIONS	MIN (Note 7)	TYP	MAX (Note 7)	UNIT
Output Voltage	$V_{OUT}$			3.0		V
$V_{OUT}$ Accuracy at $T_A = +25^\circ C$ (Note 11)	$V_{OA}$		-0.2		+0.2	%
Output Voltage Temperature Coefficient (Note 8)	TC $V_{OUT}$			15	<b>50</b>	ppm/ $^\circ C$
Input Voltage Range	$V_{IN}$		<b>3.1</b>		<b>5.5</b>	V
Supply Current	$I_{IN}$	$T_A = +25^\circ C$		48	80	$\mu A$
		$T_A = -40^\circ C$ to $+125^\circ C$			<b>100</b>	$\mu A$
Line Regulation	$\Delta V_{OUT}/\Delta V_{IN}$	$3.1 V \leq V_{IN} \leq 5.5V$		73	<b>230</b>	$\mu V/V$
Load Regulation	$\Delta V_{OUT}/\Delta I_{OUT}$	Sourcing: $0mA \leq I_{OUT} \leq 25mA$		48	<b>110</b>	$\mu V/mA$
		Sinking: $-1mA \leq I_{OUT} \leq 0mA$		10		$\mu V/mA$
Dropout Voltage (Note 9)	$V_{INDO}$	$I_{OUT} = 10mA$		60	<b>150</b>	mV
Short-Circuit Current	$I_{SC}$	$T_A = +25^\circ C$ , $V_{OUT}$ tied to GND		126		mA
Turn-On Settling Time	$t_R$	$V_{OUT} = \pm 0.1\%$ , $C_{OUT} = 1\mu F$		300		$\mu s$
Ripple Rejection		$f = 120Hz$		62		dB
Output Voltage Noise	$e_N$	$0.1Hz \leq f \leq 10Hz$		86		$\mu V_{p-p}$
Broadband Voltage Noise	$V_N$	$10Hz \leq f \leq 1kHz$		36		$\mu V_{RMS}$
Thermal Hysteresis (Note 10)	$\Delta V_{OUT}/\Delta T_A$	$\Delta T_A = +165^\circ C$		100		ppm
Long Term Stability	$\Delta V_{OUT}/\Delta t$	1000 hours, $T_A = +25^\circ C$		50		ppm

**Electrical Specifications (ISL21010-33,  $V_{OUT} = 3.3V$ )**  $V_{IN} = 5.0V$ ,  $T_A = +25^\circ C$ ,  $I_{OUT} = 0A$ , unless otherwise specified.  
**Boldface limits apply across the operating temperature range,  $-40^\circ C$  to  $+125^\circ C$ .**

PARAMETER	SYMBOL	TEST CONDITIONS	MIN (Note 7)	TYP	MAX (Note 7)	UNIT
Output Voltage	$V_{OUT}$			3.3		V
$V_{OUT}$ Accuracy at $T_A = +25^\circ C$ (Note 11)	$V_{OA}$		-0.2		+0.2	%
Output Voltage Temperature Coefficient (Note 8)	TC $V_{OUT}$			15	<b>50</b>	ppm/ $^\circ C$
Input Voltage Range	$V_{IN}$		<b>3.4</b>		<b>5.5</b>	V
Supply Current	$I_{IN}$	$T_A = +25^\circ C$		48	80	$\mu A$
		$T_A = -40^\circ C$ to $+125^\circ C$			<b>100</b>	$\mu A$
Line Regulation	$\Delta V_{OUT}/\Delta V_{IN}$	$3.4 V \leq V_{IN} \leq 5.5V$		80	<b>320</b>	$\mu V/V$
Load Regulation	$\Delta V_{OUT}/\Delta I_{OUT}$	Sourcing: $0mA \leq I_{OUT} \leq 25mA$		45	<b>110</b>	$\mu V/mA$
		Sinking: $-1mA \leq I_{OUT} \leq 0mA$		10		$\mu V/mA$
Dropout Voltage (Note 9)	$V_{INDO}$	$I_{OUT} = 10mA$		60	<b>150</b>	mV
Short-Circuit Current	$I_{SC}$	$T_A = +25^\circ C$ , $V_{OUT}$ tied to GND		126		mA
Turn-On Settling Time	$t_R$	$V_{OUT} = \pm 0.1\%$ , $C_{OUT} = 1\mu F$		300		$\mu s$
Ripple Rejection		$f = 120Hz$		61		dB
Output Voltage Noise	$e_N$	$0.1Hz \leq f \leq 10Hz$		95		$\mu V_{p-p}$
Broadband Voltage Noise	$V_N$	$10Hz \leq f \leq 1kHz$		40		$\mu V_{RMS}$
Thermal Hysteresis (Note 10)	$\Delta V_{OUT}/\Delta T_A$	$\Delta T_A = +165^\circ C$		100		ppm
Long Term Stability	$\Delta V_{OUT}/\Delta t$	1000 hours, $T_A = +25^\circ C$		50		ppm



**Electrical Specifications (ISL21010-41,  $V_{OUT} = 4.096V$ )**  $V_{IN} = 5.0V$ ,  $T_A = +25^\circ C$ ,  $I_{OUT} = 0A$ , unless otherwise specified. **Boldface limits apply across the operating temperature range,  $-40^\circ C$  to  $+125^\circ C$ .**

PARAMETER	SYMBOL	TEST CONDITIONS	MIN (Note 7)	TYP	MAX (Note 7)	UNIT
Output Voltage	$V_{OUT}$			4.096		V
$V_{OUT}$ Accuracy at $T_A = +25^\circ C$ (Note 11)	$V_{OA}$		-0.2		+0.2	%
Output Voltage Temperature Coefficient (Note 8)	TC $V_{OUT}$			15	<b>50</b>	ppm/ $^\circ C$
Input Voltage Range	$V_{IN}$		<b>4.2</b>		<b>5.5</b>	V
Supply Current	$I_{IN}$	$T_A = +25^\circ C$		48	<b>80</b>	$\mu A$
		$T_A = -40^\circ C$ to $+125^\circ C$			<b>100</b>	$\mu A$
Line Regulation	$\Delta V_{OUT} / \Delta V_{IN}$	$4.2 V \leq V_{IN} \leq 5.5V$		106	<b>550</b>	$\mu V/V$
Load Regulation	$\Delta V_{OUT} / \Delta I_{OUT}$	Sourcing: $0mA \leq I_{OUT} \leq 25mA$		50	<b>140</b>	$\mu V/mA$
		Sinking: $-1mA \leq I_{OUT} \leq 0mA$		50		$\mu V/mA$
Dropout Voltage (Note 9)	$V_{INDO}$	$I_{OUT} = 10mA$		60	<b>150</b>	mV
Short-Circuit Current	$I_{SC}$	$T_A = +25^\circ C$ , $V_{OUT}$ tied to GND		126		mA
Turn-On Settling Time	$t_R$	$V_{OUT} = \pm 0.1\%$ , $C_{OUT} = 1\mu F$		300		$\mu s$
Ripple Rejection		$f = 120Hz$		58		dB
Output Voltage Noise	$e_N$	$0.1Hz \leq f \leq 10Hz$		112		$\mu V_{P-P}$
Broadband Voltage Noise	$V_N$	$10Hz \leq f \leq 1kHz$		56		$\mu V_{RMS}$
Thermal Hysteresis (Note 10)	$\Delta V_{OUT} / \Delta T_A$	$\Delta T_A = +165^\circ C$		100		ppm
Long Term Stability	$\Delta V_{OUT} / \Delta t$	1000 hours, $T_A = +25^\circ C$		110		ppm

## NOTES:

- Compliance to datasheet limits is assured by one or more methods: production test, characterization, and/or design.
- Over the specified temperature range. Temperature coefficient is measured by the box method whereby the change in  $V_{OUT}$  is divided by the temperature range; in this case,  $-40^\circ C$  to  $+125^\circ C = +165^\circ C$ .
- Dropout Voltage is the minimum  $V_{IN} - V_{OUT}$  differential voltage measured at the point where  $V_{OUT}$  drops 1mV from  $V_{IN} =$  nominal at  $T_A = +25^\circ C$ .
- Thermal Hysteresis is the change of  $V_{OUT}$  measured at  $T_A = +25^\circ C$  after temperature cycling over a specified range,  $\Delta T_A$ .  $V_{OUT}$  is read initially at  $T_A = +25^\circ C$  for the device under test. The device is temperature cycled and a second  $V_{OUT}$  measurement is taken at  $+25^\circ C$ . The difference between the initial  $V_{OUT}$  reading and the second  $V_{OUT}$  reading is then expressed in ppm. For  $\Delta T_A = +165^\circ C$ , the device under test is cycled from  $+25^\circ C$  to  $-40^\circ C$  to  $+125^\circ C$  to  $+25^\circ C$ .
- Post-reflow drift for the ISL21010 devices may shift up to 4.0mV based on simulated reflow at  $260^\circ C$  peak temperature, three passes. The system design engineer must take this into account when considering the reference voltage after assembly.

## Typical Performance Characteristics Curves ( $V_{OUT} = 1.024V$ )

$V_{IN} = 3.0V$ ,  $I_{OUT} = 0mA$ ,  $T_A = +25^\circ C$  unless otherwise specified.

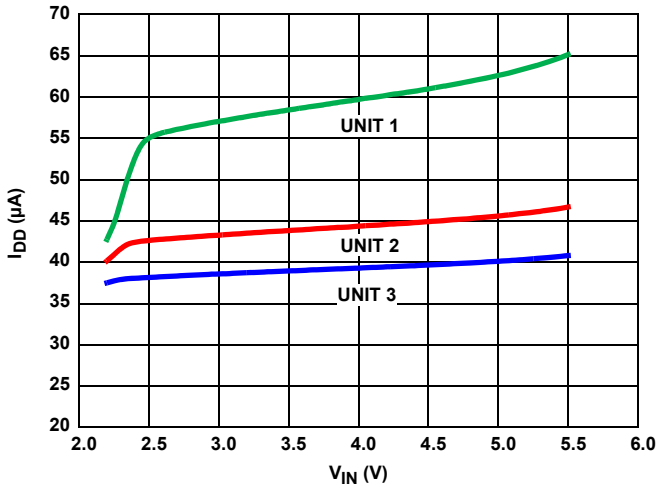

FIGURE 3.  $I_{IN}$  vs  $V_{IN}$ , THREE UNITS

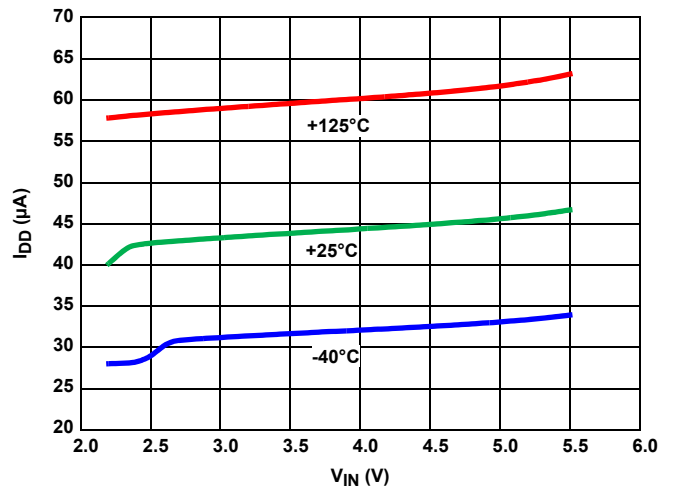

FIGURE 4.  $I_{IN}$  vs  $V_{IN}$ , OVER-TEMPERATURE

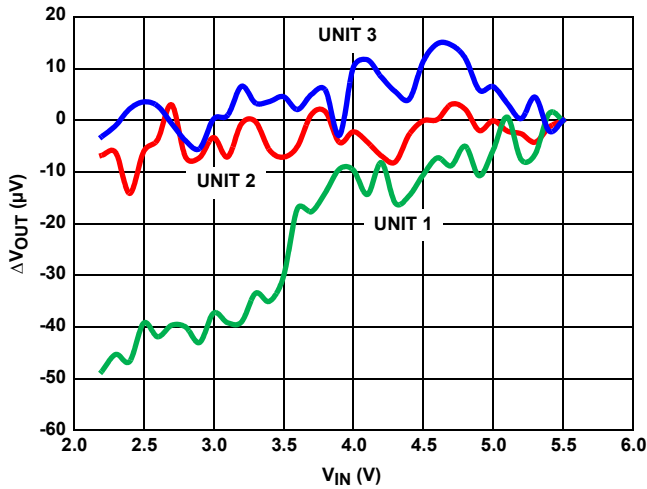

FIGURE 5. LINE REGULATION, THREE UNITS

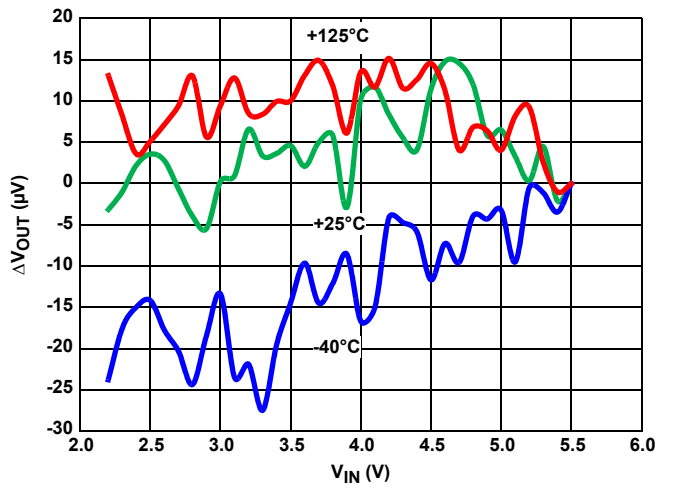

FIGURE 6. LINE REGULATION OVER-TEMPERATURE

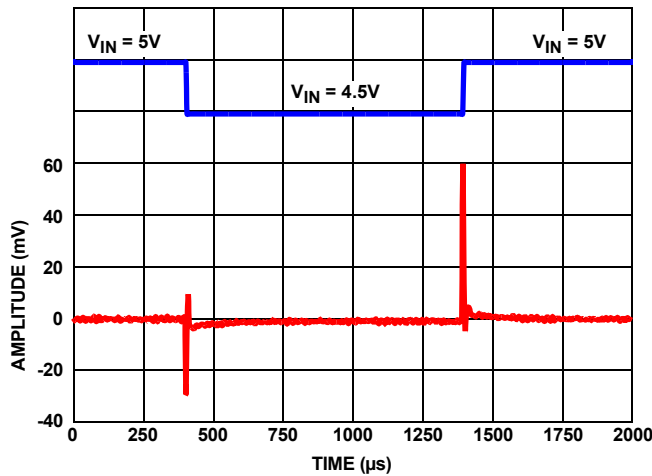

FIGURE 7. LINE TRANSIENT RESPONSE WITH 0.22µF LOAD

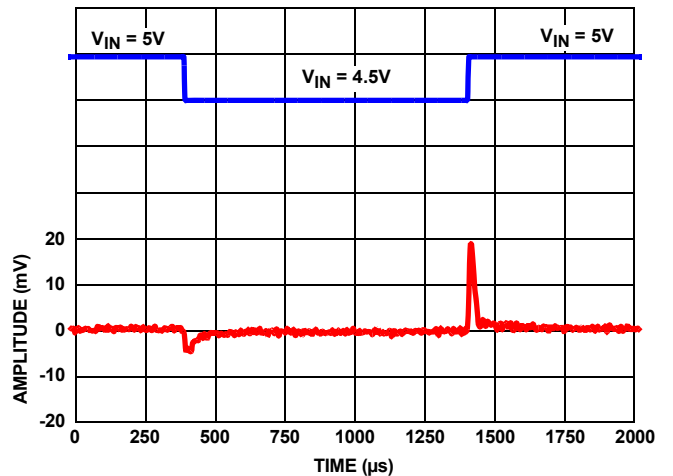

FIGURE 8. LINE TRANSIENT RESPONSE WITH 10µF LOAD

# Typical Performance Characteristics Curves ( $V_{OUT} = 1.024V$ )

$V_{IN} = 3.0V$ ,  $I_{OUT} = 0mA$ ,  $T_A = +25^\circ C$  unless otherwise specified. (Continued)

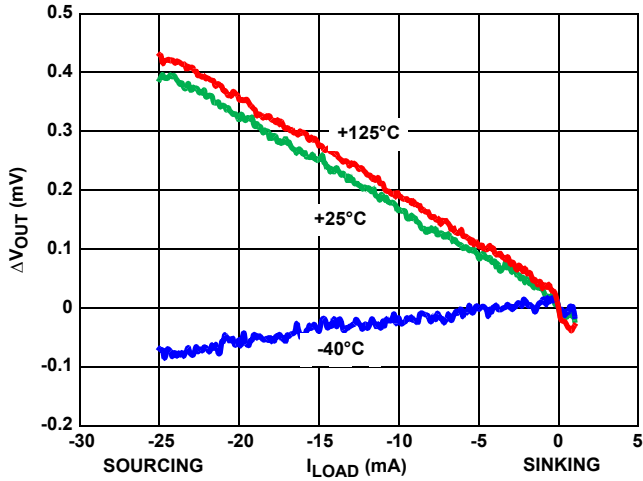

FIGURE 9. LOAD REGULATION OVER-TEMPERATURE

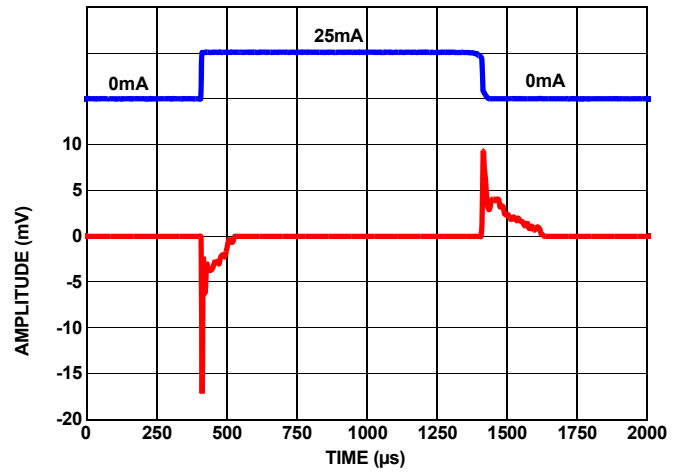

FIGURE 10. LOAD TRANSIENT RESPONSE AT 25mA LOAD AT 1μF

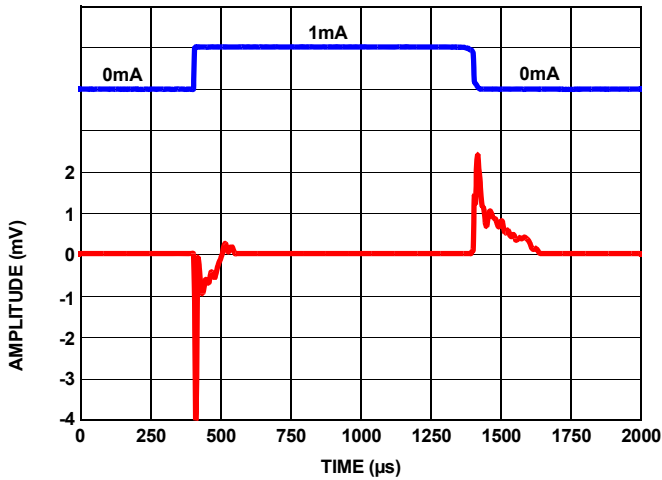

FIGURE 11. LOAD TRANSIENT RESPONSE AT 1mA LOAD AT 1μF

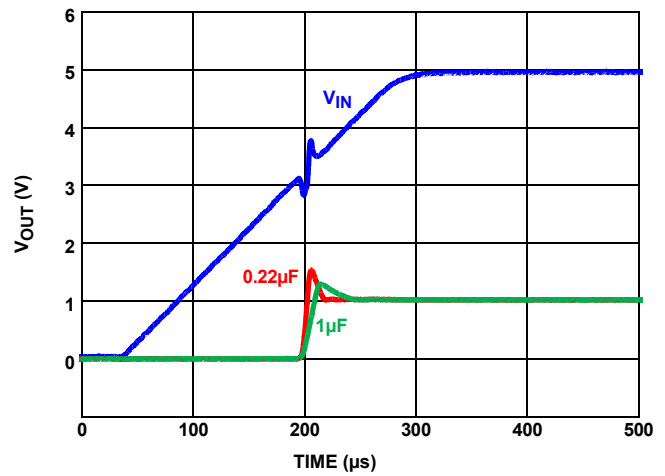

FIGURE 12. TURN-ON TIME

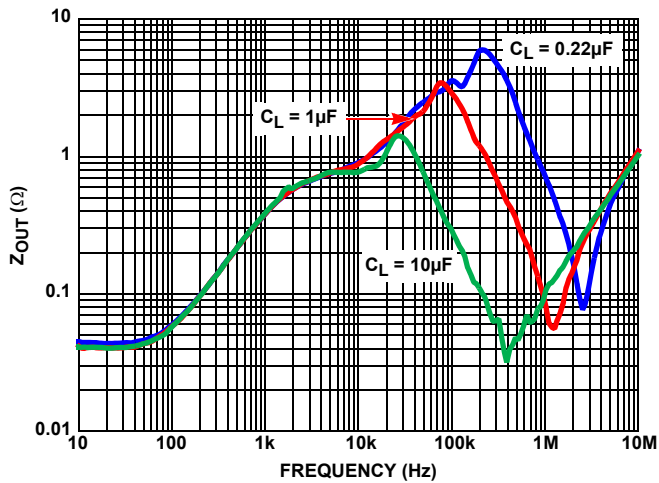

FIGURE 13.  $Z_{OUT}$  vs FREQUENCY

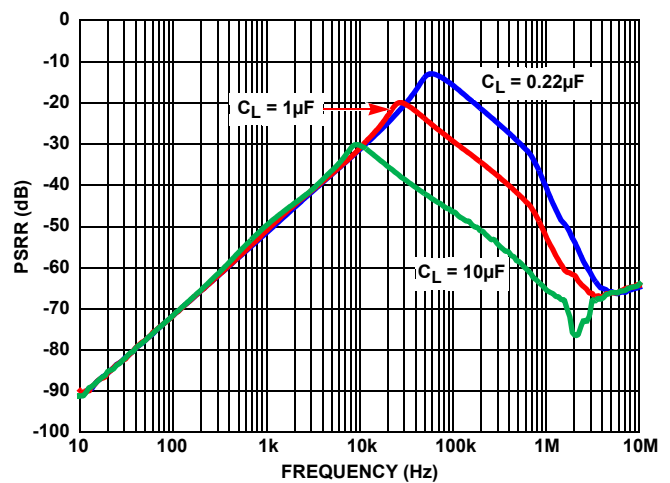

FIGURE 14. RIPPLE REJECTION AT DIFFERENT CAPACITIVE LOADS

# Typical Performance Characteristics Curves ( $V_{OUT} = 1.024V$ )

$V_{IN} = 3.0V$ ,  $I_{OUT} = 0mA$ ,  $T_A = +25^\circ C$  unless otherwise specified. (Continued)

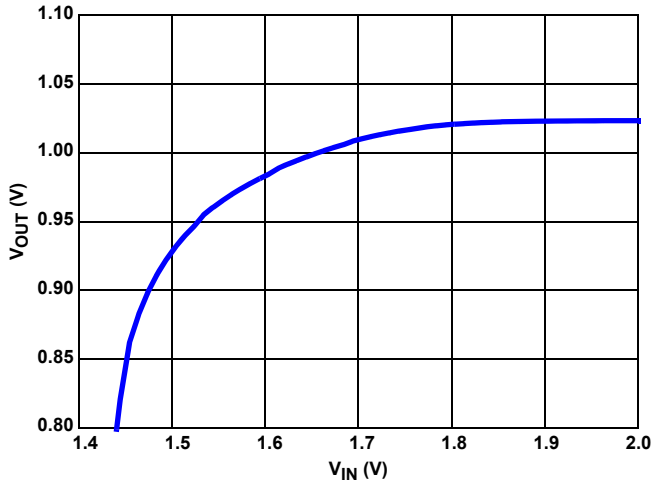

FIGURE 15. DROPOUT (10mA SOURCED LOAD)

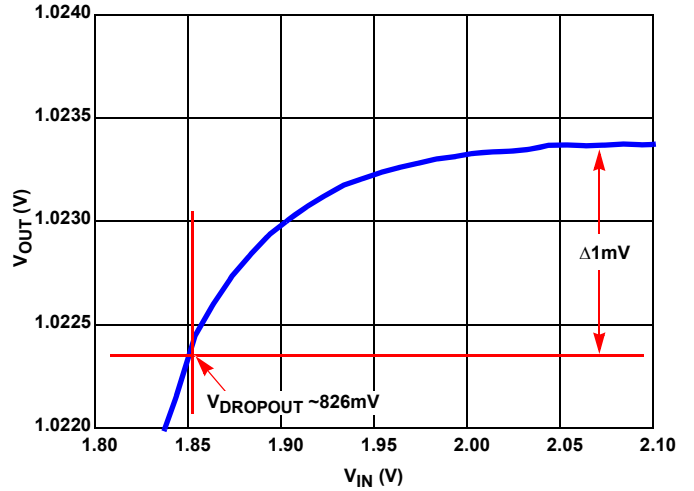

FIGURE 16. DROPOUT ZOOMED (10mA SOURCED LOAD)

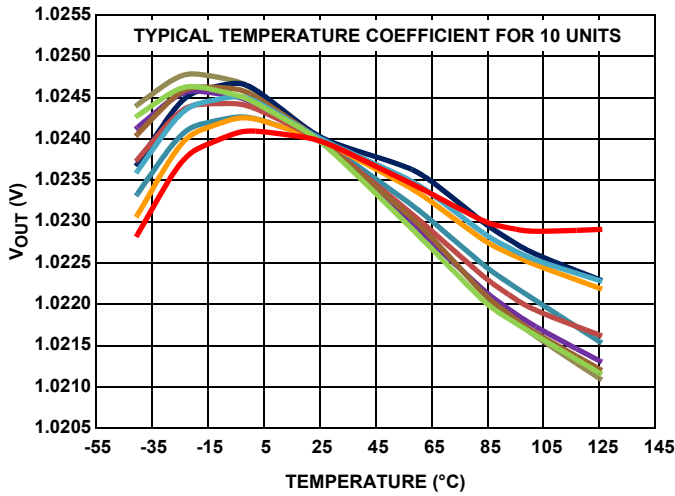

FIGURE 17.  $V_{OUT}$  vs TEMPERATURE

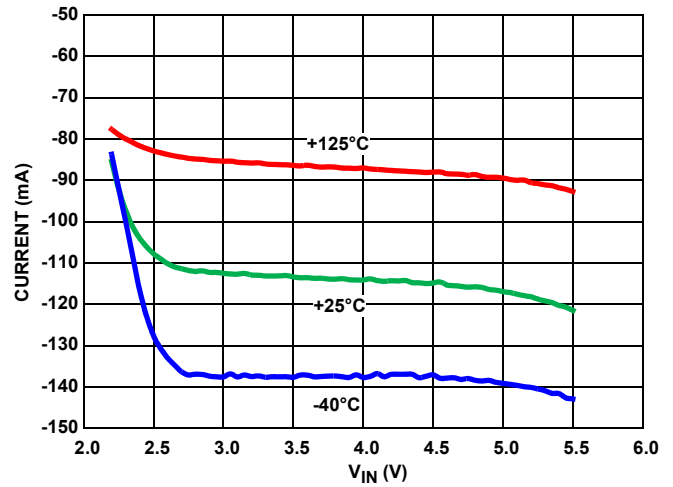

FIGURE 18. SHORT CIRCUIT TO GND

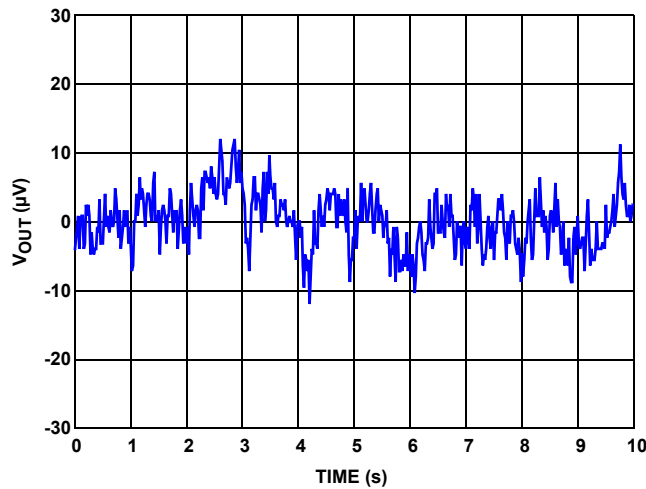

FIGURE 19.  $V_{OUT}$  vs NOISE, 0.1Hz TO 10Hz

## Typical Performance Characteristics Curves ( $V_{OUT} = 1.25V$ )

$V_{IN} = 3.0V$ ,  $I_{OUT} = 0mA$ ,  $T_A = +25^\circ C$  unless otherwise specified.

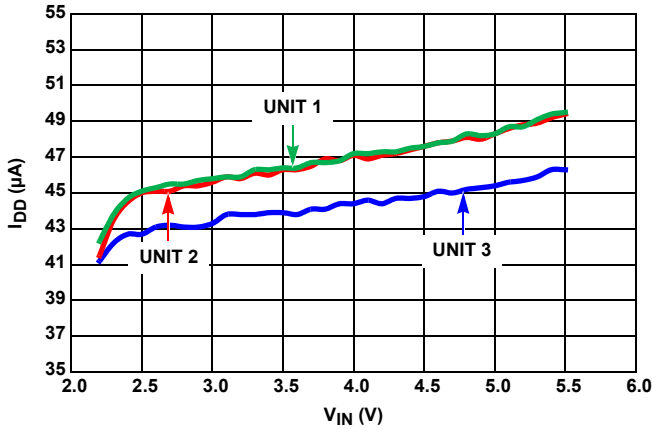

FIGURE 20.  $I_{IN}$  vs  $V_{IN}$ , THREE UNITS

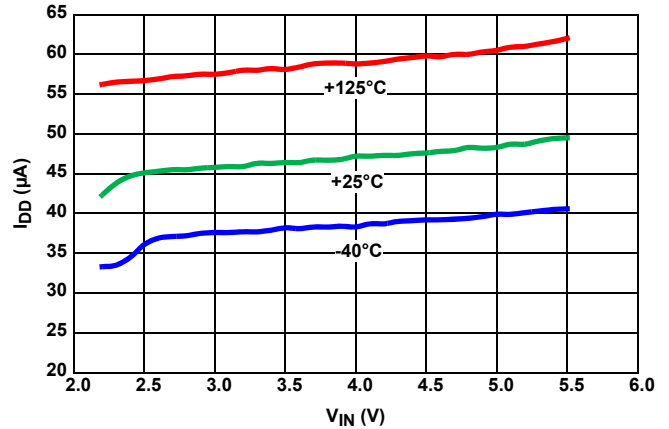

FIGURE 21.  $I_{IN}$  vs  $V_{IN}$ , OVER-TEMPERATURE

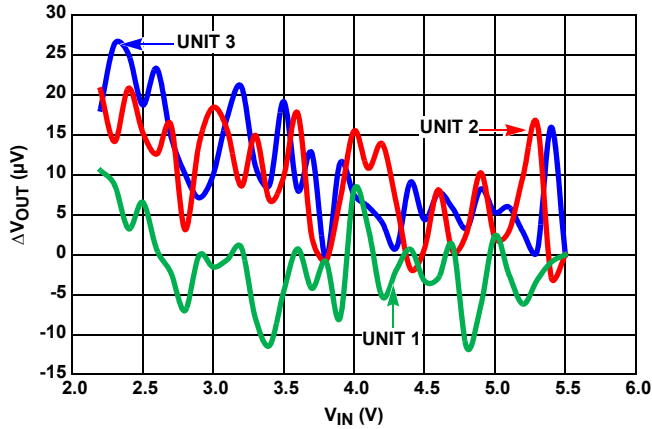

FIGURE 22. LINE REGULATION, THREE UNITS

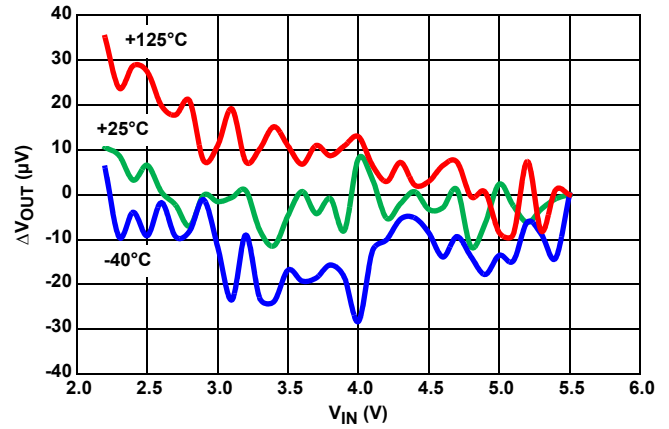

FIGURE 23. LINE REGULATION OVER-TEMPERATURE

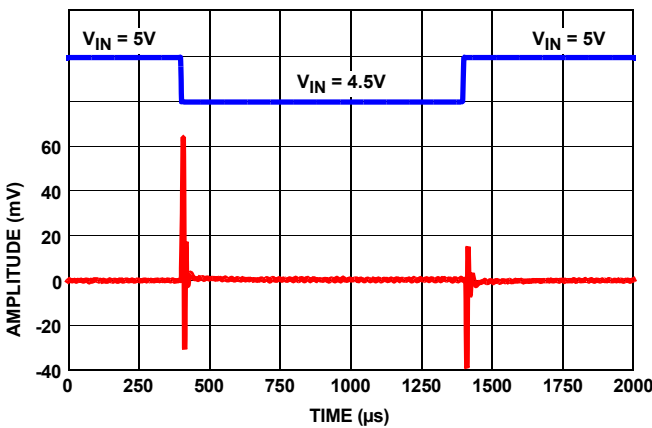

FIGURE 24. LINE TRANSIENT RESPONSE WITH  $0.1\mu F$  LOAD

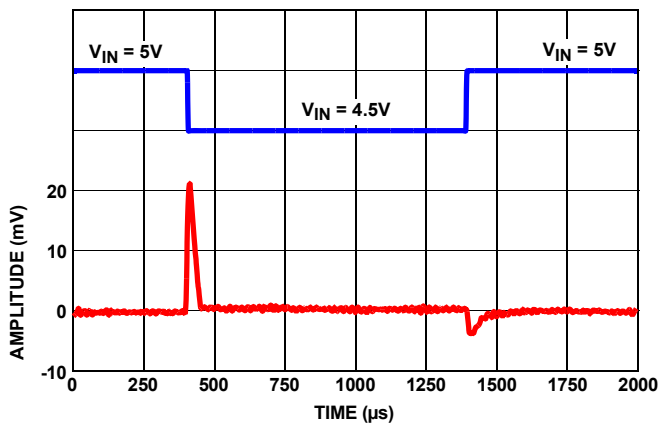

FIGURE 25. LINE TRANSIENT RESPONSE WITH  $10\mu F$  LOAD

# Typical Performance Characteristics Curves ( $V_{OUT} = 1.25V$ )

$V_{IN} = 3.0V$ ,  $I_{OUT} = 0mA$ ,  $T_A = +25^\circ C$  unless otherwise specified. (Continued)

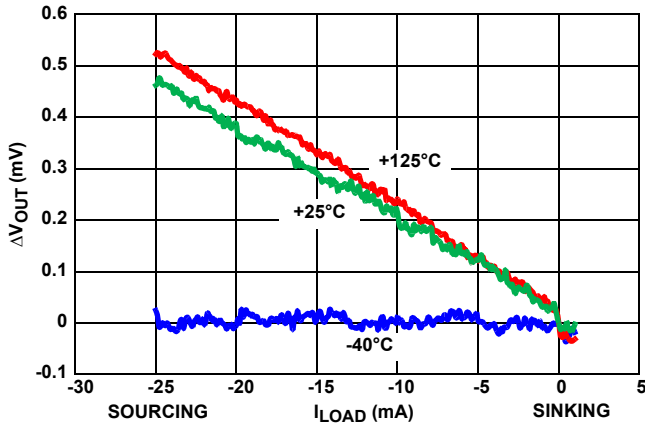

FIGURE 26. LOAD REGULATION OVER-TEMPERATURE

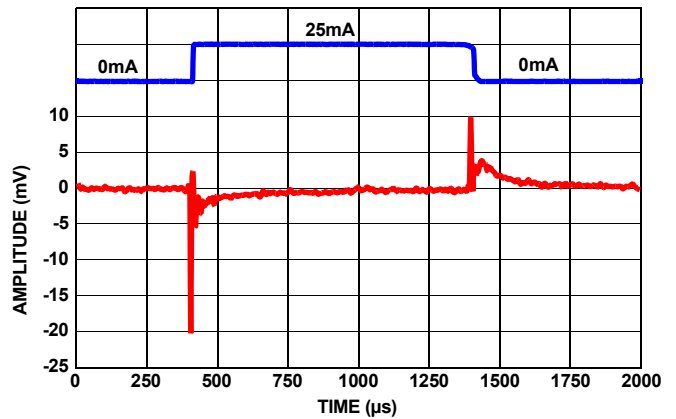

FIGURE 27. LOAD TRANSIENT RESPONSE AT 25mA LOAD AT 1μF

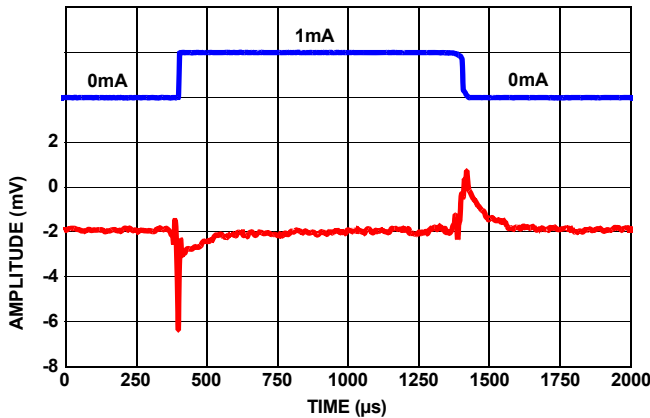

FIGURE 28. LOAD TRANSIENT RESPONSE AT 1mA LOAD AT 1μF

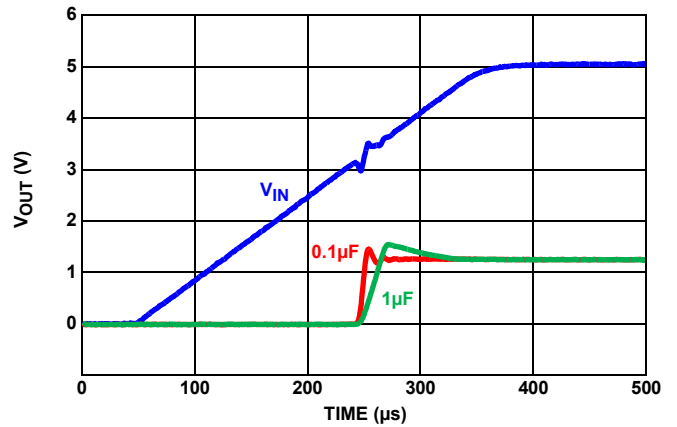

FIGURE 29. TURN-ON TIME

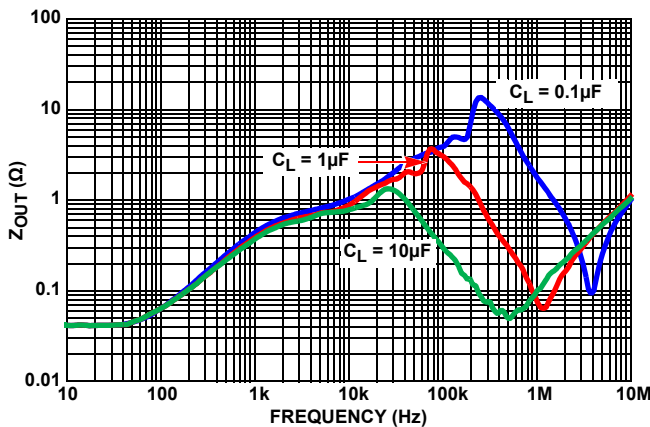

FIGURE 30.  $Z_{OUT}$  vs FREQUENCY

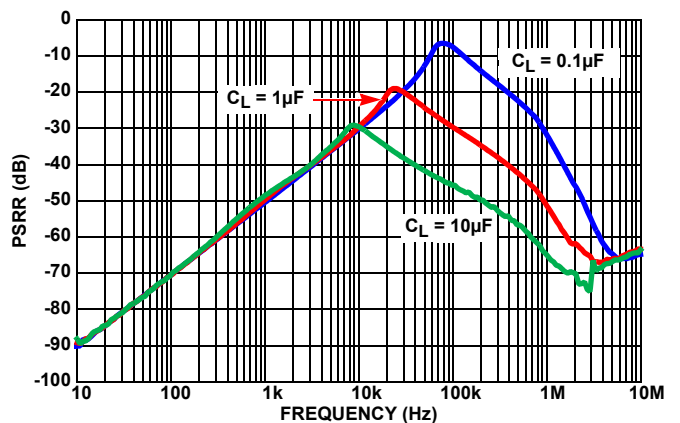

FIGURE 31. RIPPLE REJECTION AT DIFFERENT CAPACITIVE LOADS

# Typical Performance Characteristics Curves ( $V_{OUT} = 1.25V$ )

$V_{IN} = 3.0V$ ,  $I_{OUT} = 0mA$ ,  $T_A = +25^\circ C$  unless otherwise specified. (Continued)

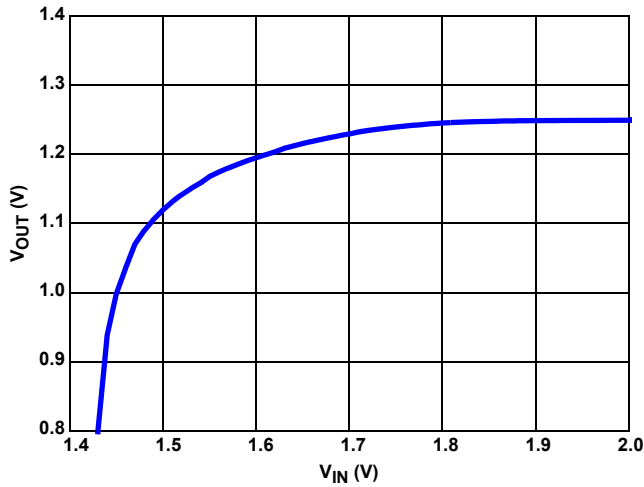

FIGURE 32. DROPOUT (10mA SOURCED LOAD)

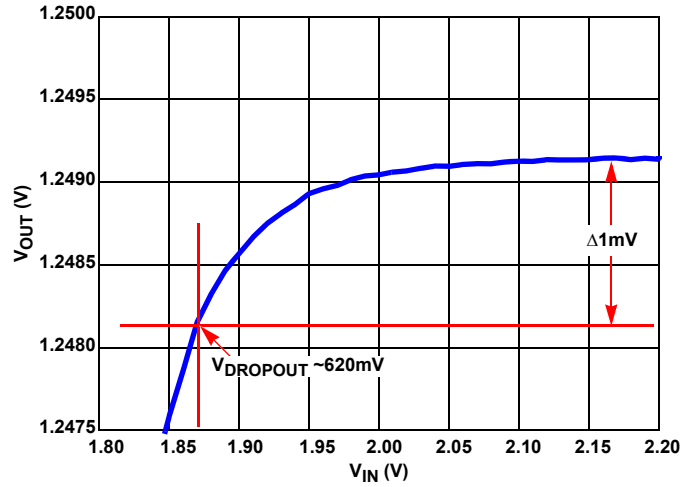

FIGURE 33. DROPOUT ZOOMED (10mA SOURCED LOAD)

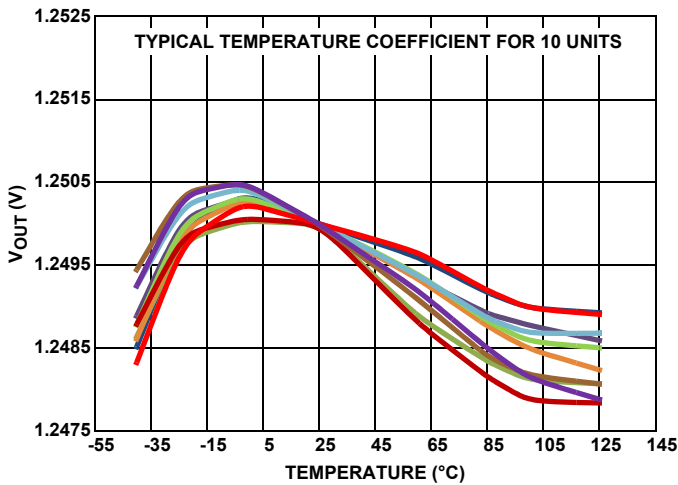

FIGURE 34.  $V_{OUT}$  vs TEMPERATURE

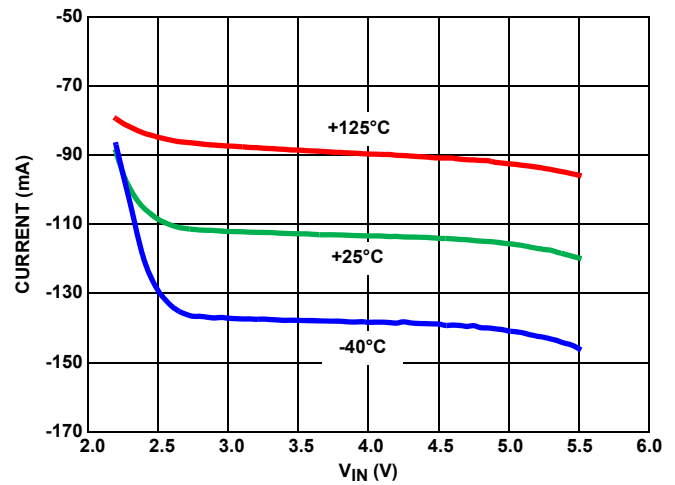

FIGURE 35. SHORT-CIRCUIT TO GND

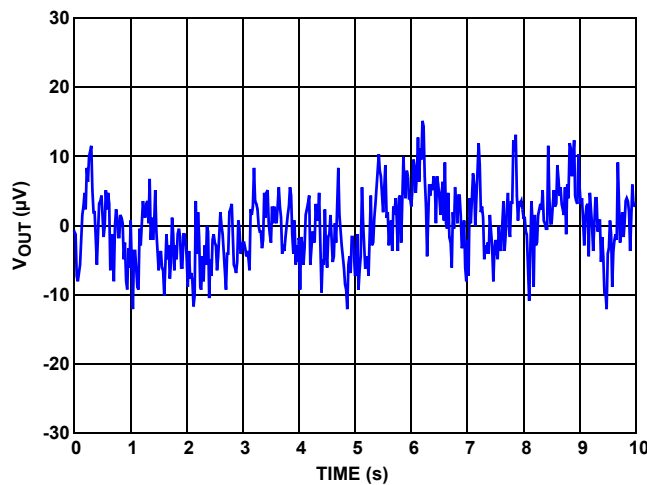

FIGURE 36.  $V_{OUT}$  vs NOISE, 0.1Hz TO 10Hz

## Typical Performance Characteristics Curves ( $V_{OUT} = 1.5V$ )

$V_{IN} = 3.0V$ ,  $I_{OUT} = 0mA$ ,  $T_A = +25^\circ C$  unless otherwise specified.

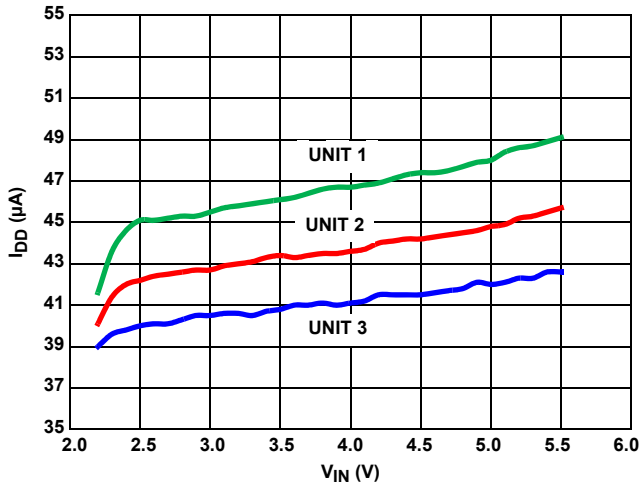

FIGURE 37.  $I_{IN}$  vs  $V_{IN}$ , THREE UNITS

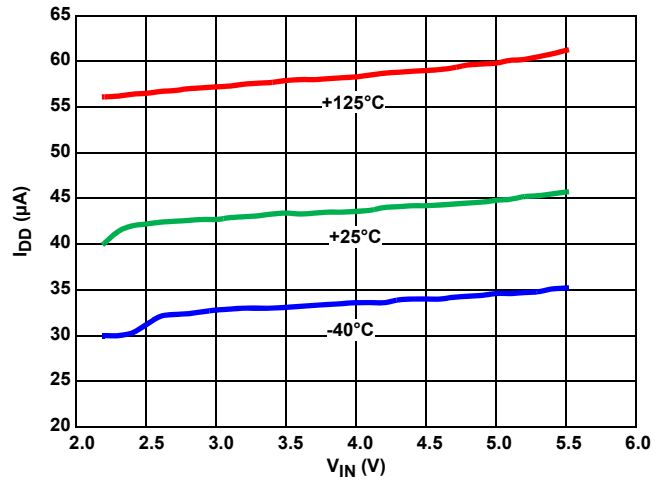

FIGURE 38.  $I_{IN}$  vs  $V_{IN}$ , OVER-TEMPERATURE

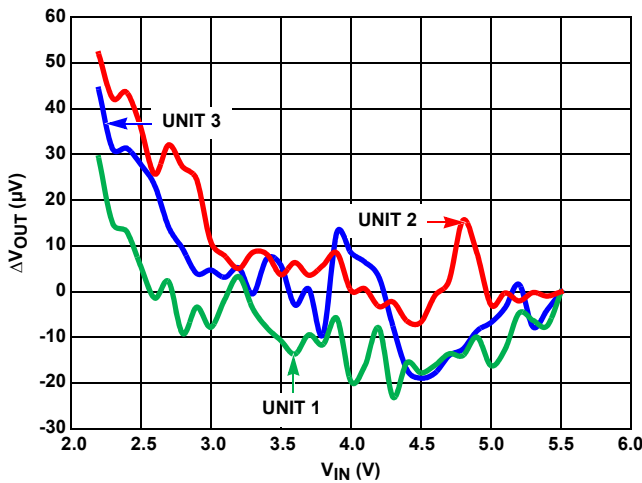

FIGURE 39. LINE REGULATION, THREE UNITS

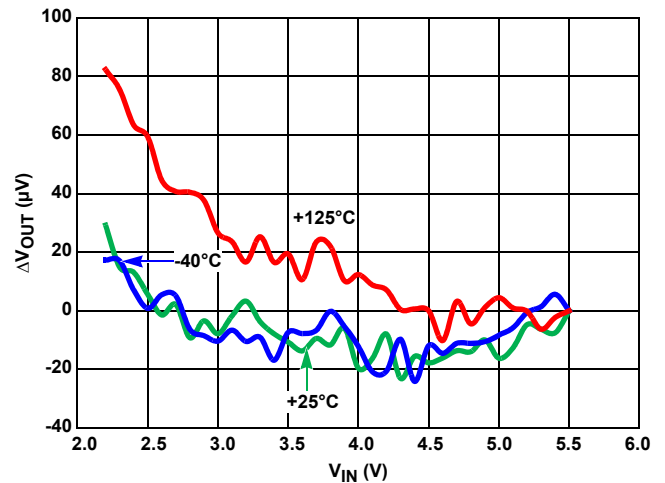

FIGURE 40. LINE REGULATION OVER-TEMPERATURE

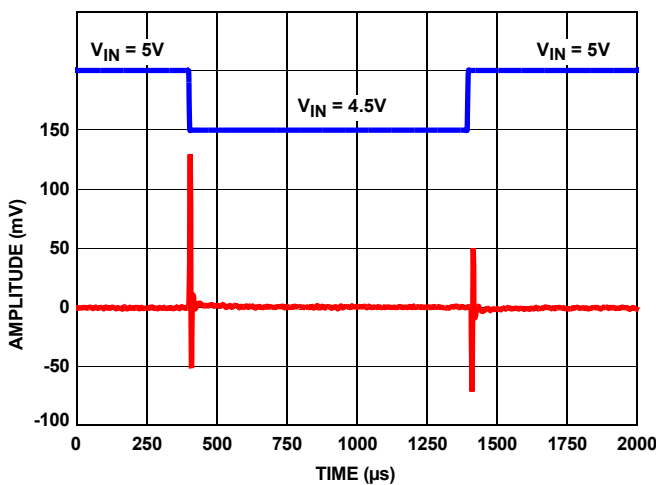

FIGURE 41. LINE TRANSIENT RESPONSE WITH  $0.1\mu F$  LOAD

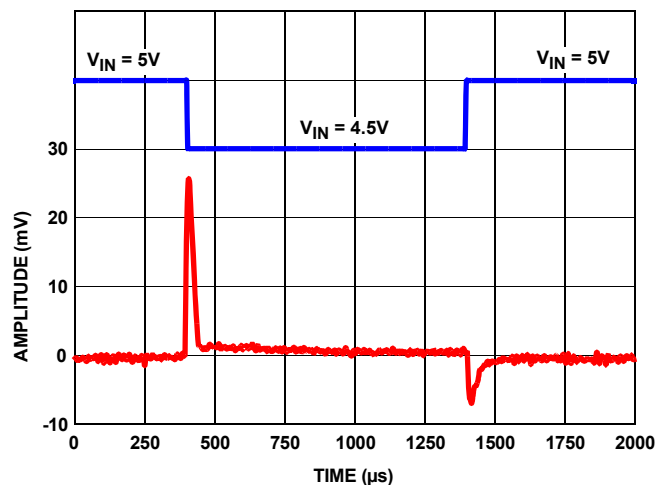

FIGURE 42. LINE TRANSIENT RESPONSE WITH  $10\mu F$  LOAD



# Typical Performance Characteristics Curves ( $V_{OUT} = 1.5V$ )

$V_{IN} = 3.0V$ ,  $I_{OUT} = 0mA$ ,  $T_A = +25^\circ C$  unless otherwise specified. (Continued)

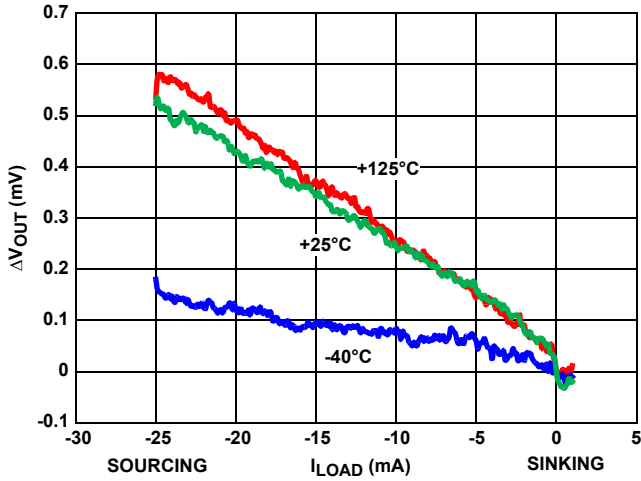

FIGURE 43. LOAD REGULATION OVER-TEMPERATURE

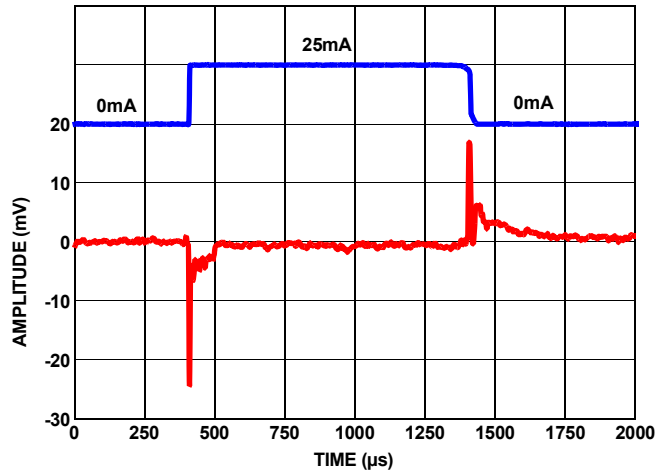

FIGURE 44. LOAD TRANSIENT RESPONSE AT 25mA LOAD AT 1μF

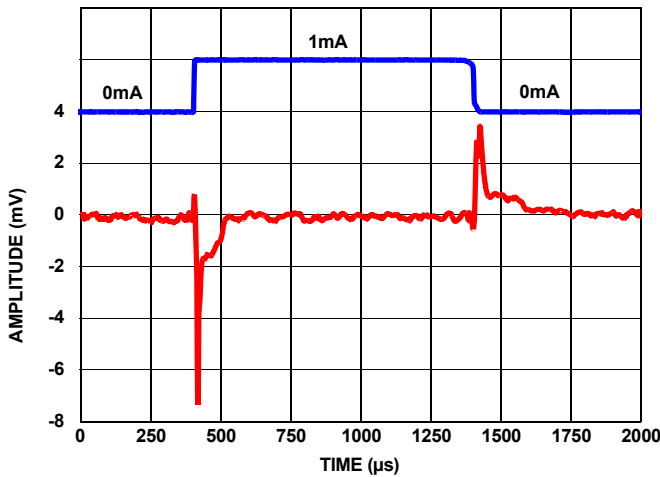

FIGURE 45. LOAD TRANSIENT RESPONSE AT 1mA LOAD AT 1μF

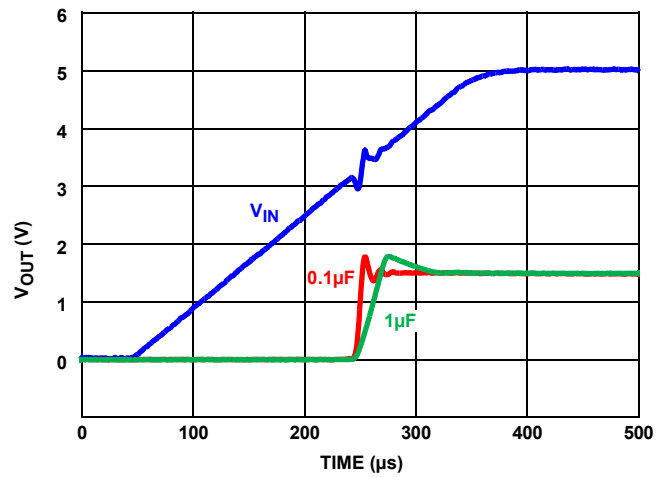

FIGURE 46. TURN-ON TIME

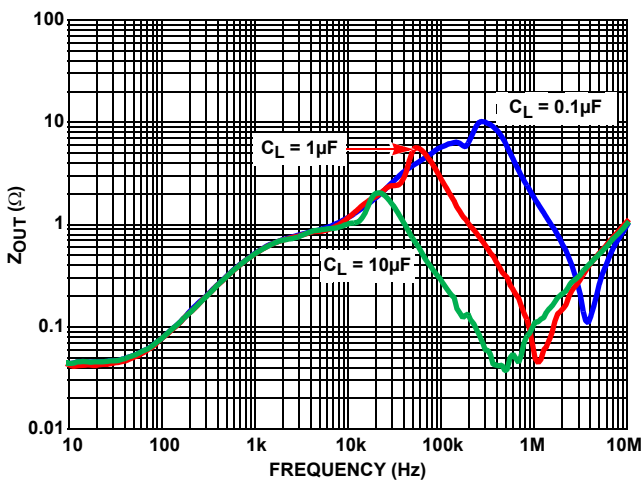

FIGURE 47.  $Z_{OUT}$  vs FREQUENCY

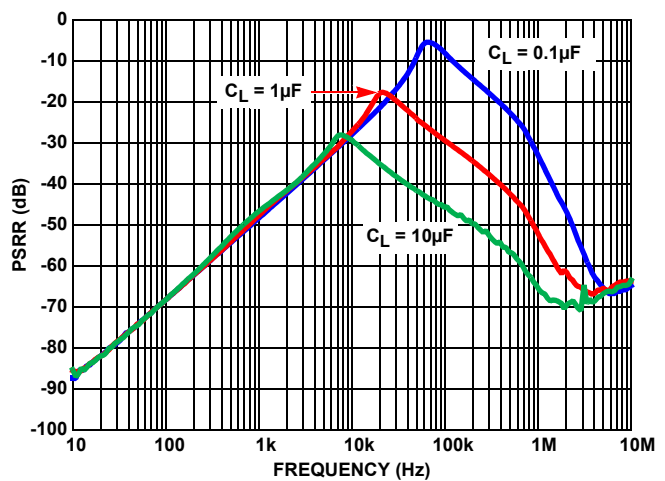

FIGURE 48. RIPPLE REJECTION AT DIFFERENT CAPACITIVE LOADS

# Typical Performance Characteristics Curves ( $V_{OUT} = 1.5V$ )

$V_{IN} = 3.0V$ ,  $I_{OUT} = 0mA$ ,  $T_A = +25^\circ C$  unless otherwise specified. (Continued)

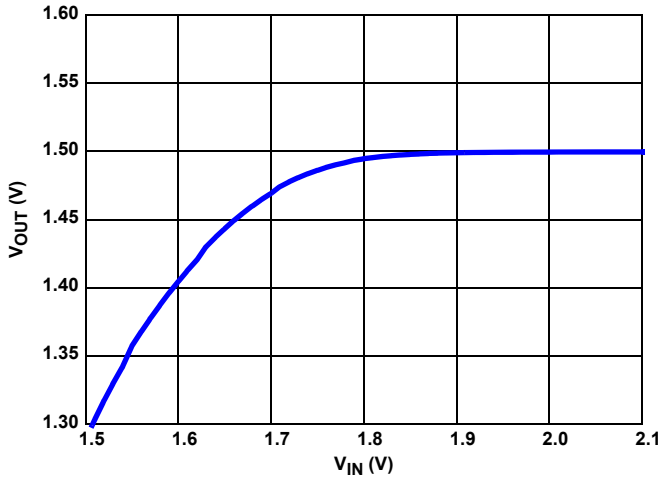

FIGURE 49. DROPOUT (10mA SOURCED LOAD)

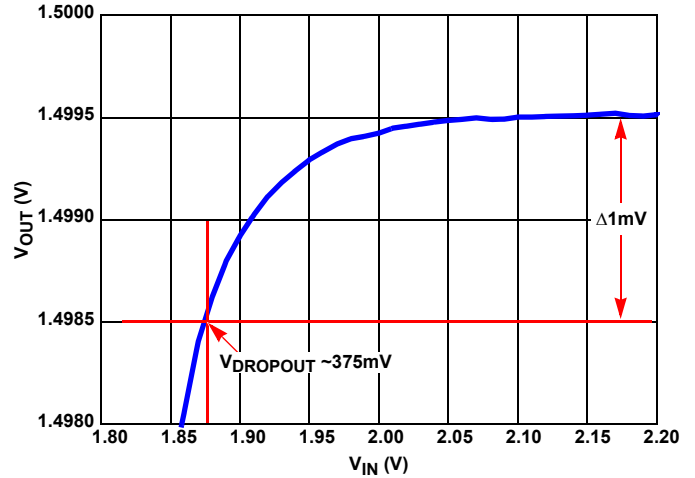

FIGURE 50. DROPOUT ZOOMED (10mA SOURCED LOAD)

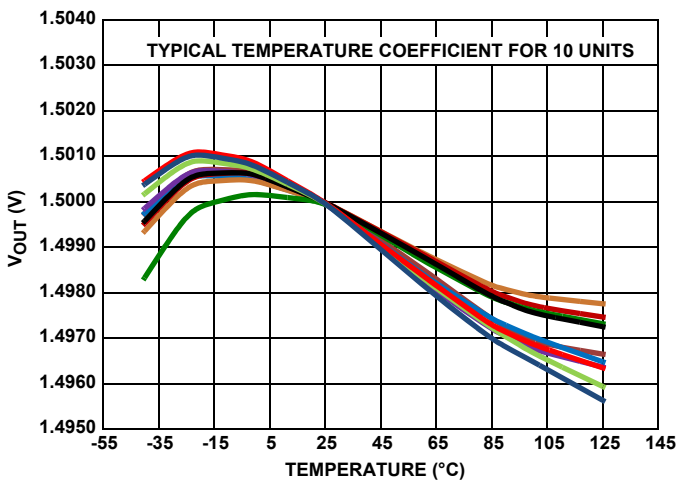

FIGURE 51.  $V_{OUT}$  vs TEMPERATURE

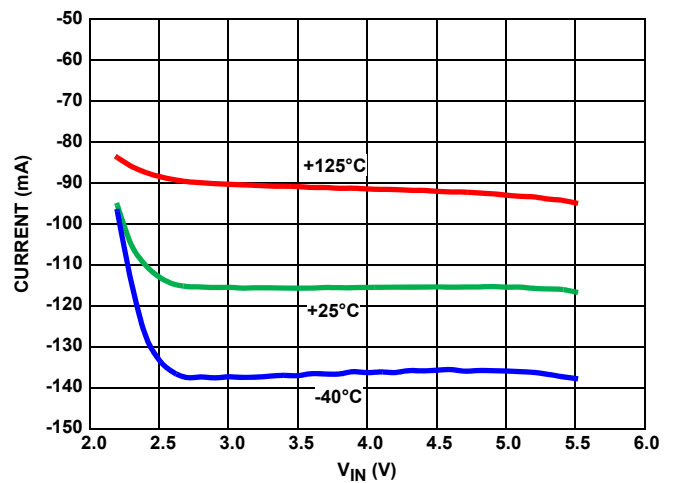

FIGURE 52. SHORT-CIRCUIT TO GND

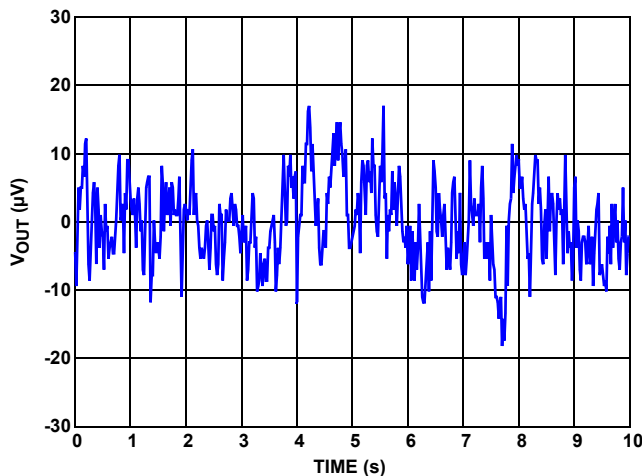

FIGURE 53.  $V_{OUT}$  vs NOISE, 0.1Hz TO 10Hz

## Typical Performance Characteristics Curves ( $V_{OUT} = 2.048V$ )

$V_{IN} = 3.0V$ ,  $I_{OUT} = 0mA$ ,  $T_A = +25^\circ C$  unless otherwise specified.

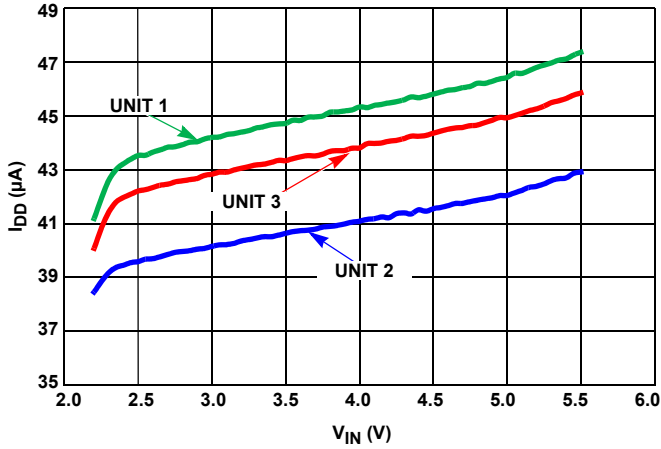

FIGURE 54.  $I_{DD}$  vs  $V_{IN}$ , THREE UNITS

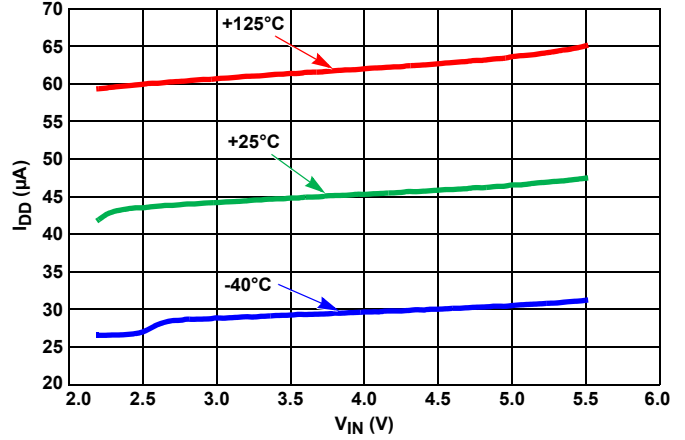

FIGURE 55.  $I_{DD}$  vs  $V_{IN}$ , OVER-TEMPERATURE

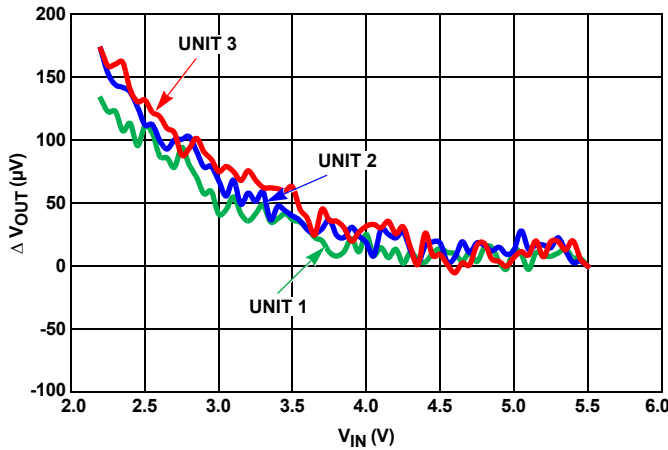

FIGURE 56. LINE REGULATION, THREE UNITS

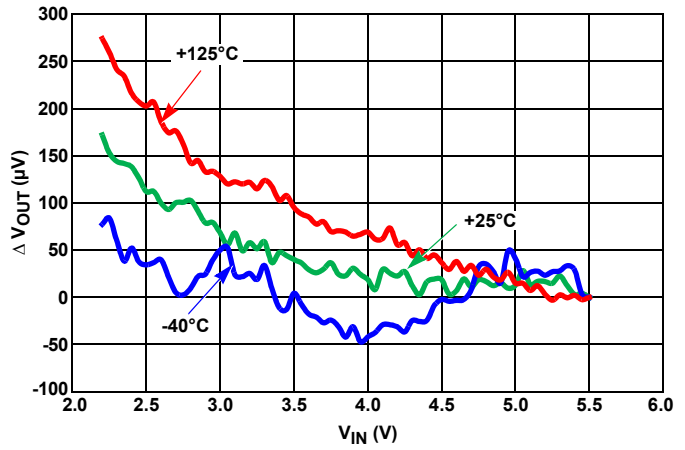

FIGURE 57. LINE REGULATION OVER-TEMPERATURE

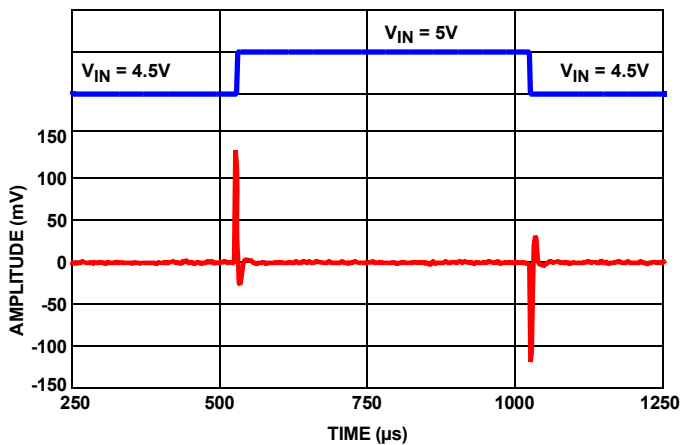

FIGURE 58. LINE TRANSIENT RESPONSE WITH  $0.1\mu F$  LOAD

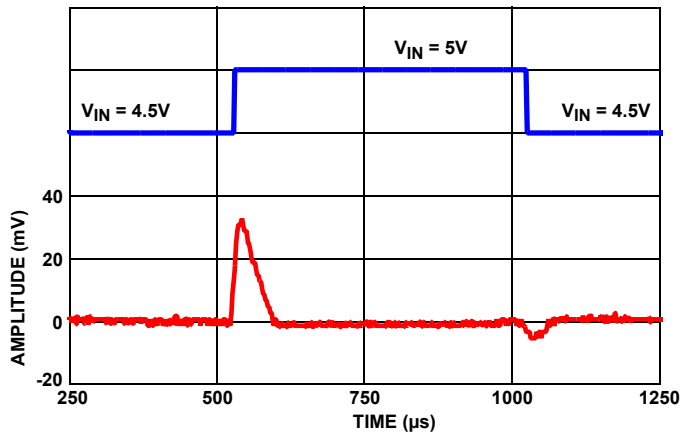

FIGURE 59. LINE TRANSIENT RESPONSE WITH  $10\mu F$  LOAD

# Typical Performance Characteristics Curves ( $V_{OUT} = 2.048V$ )

$V_{IN} = 3.0V$ ,  $I_{OUT} = 0mA$ ,  $T_A = +25^\circ C$  unless otherwise specified. (Continued)

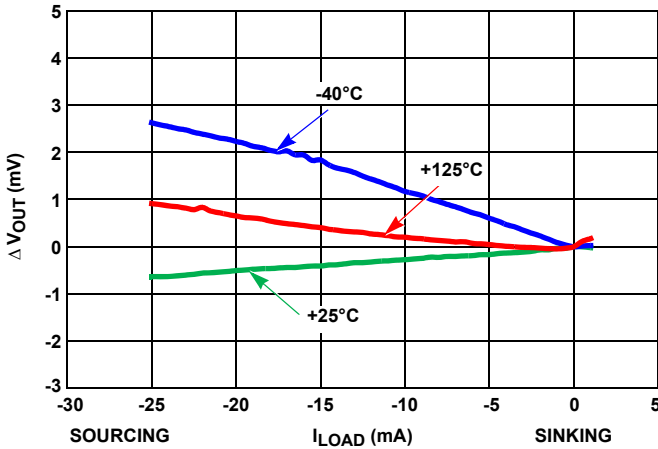

FIGURE 60. LOAD REGULATION OVER-TEMPERATURE

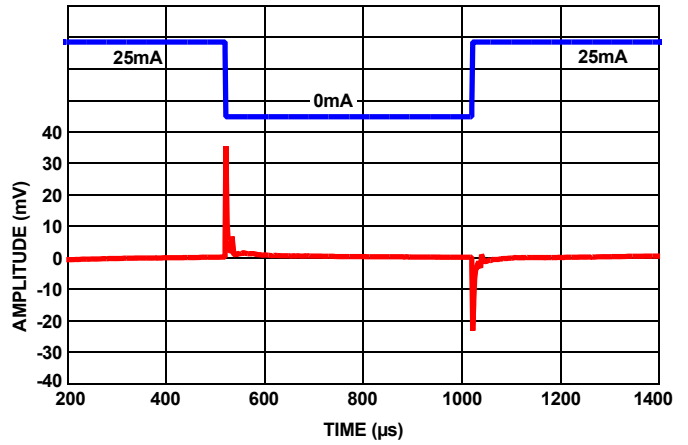

FIGURE 61. LOAD TRANSIENT RESPONSE AT 25mA LOAD AT  $1\mu F$

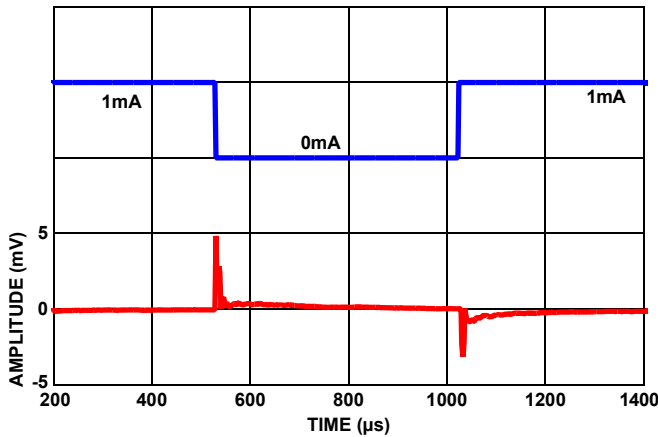

FIGURE 62. LOAD TRANSIENT RESPONSE AT 1mA LOAD AT  $1\mu F$

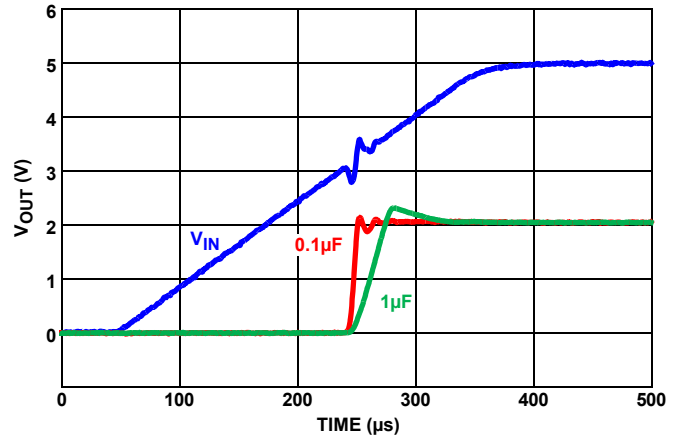

FIGURE 63. TURN-ON TIME

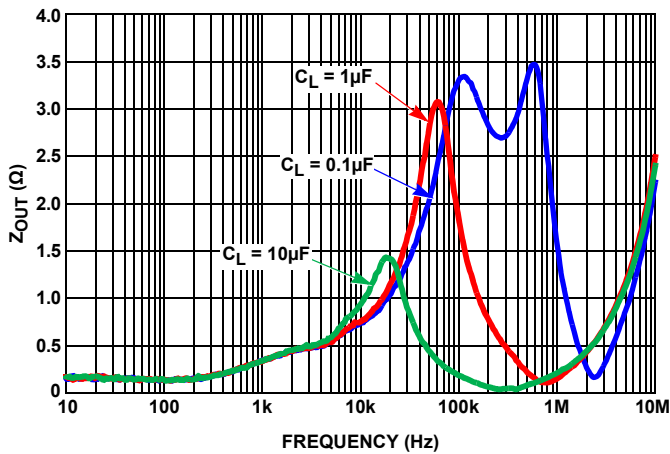

FIGURE 64.  $Z_{OUT}$  vs FREQUENCY

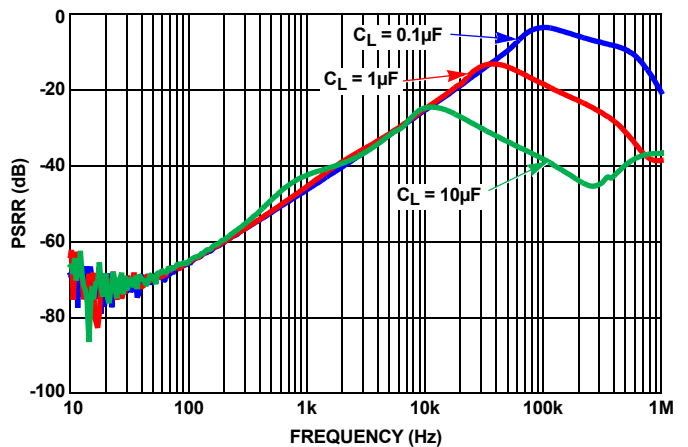

FIGURE 65. RIPPLE REJECTION AT DIFFERENT CAPACITIVE LOADS

## Typical Performance Characteristics Curves ( $V_{OUT} = 2.048V$ )

$V_{IN} = 3.0V$ ,  $I_{OUT} = 0mA$ ,  $T_A = +25^\circ C$  unless otherwise specified. (Continued)

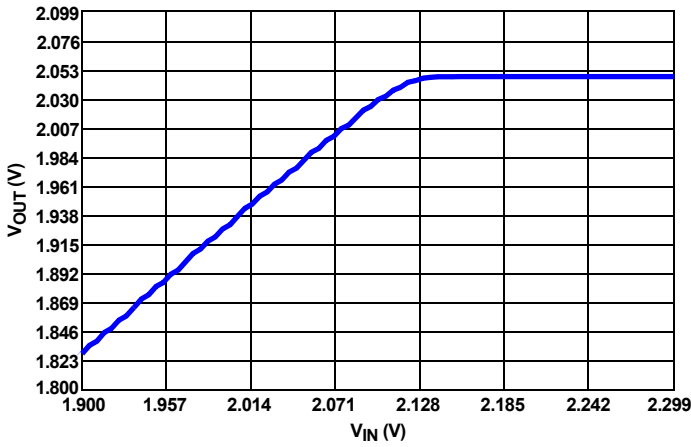

FIGURE 66. DROPOUT (10mA SOURCED LOAD)

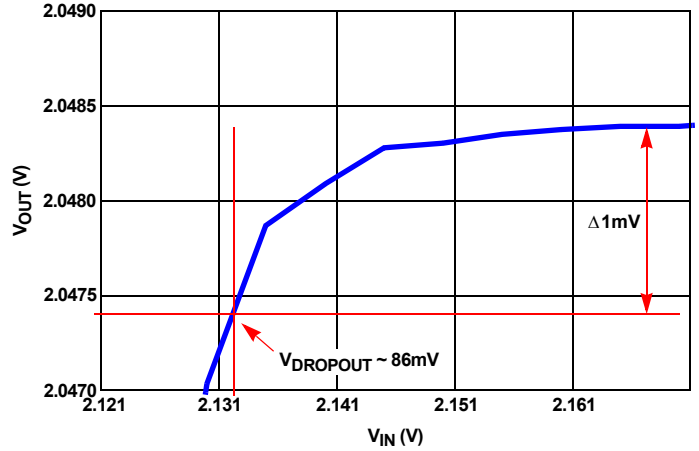

FIGURE 67. DROPOUT ZOOMED (10mA SOURCED LOAD)

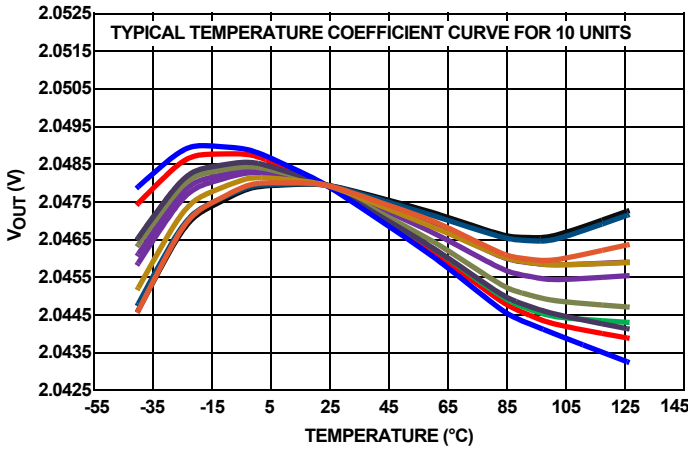

FIGURE 68.  $V_{OUT}$  vs TEMPERATURE

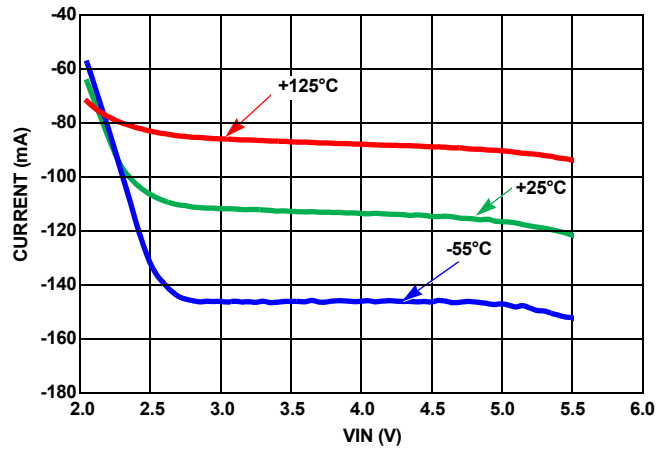

FIGURE 69. SHORT-CIRCUIT TO GND

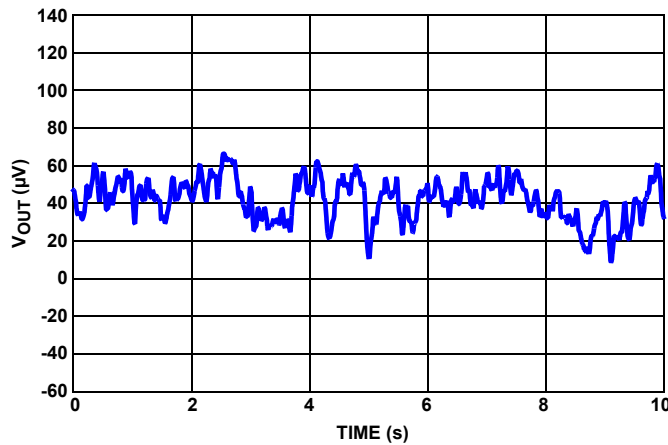

FIGURE 70.  $V_{OUT}$  vs NOISE, 0.1Hz TO 10Hz

## Typical Performance Characteristics Curves ( $V_{OUT} = 2.5V$ )

$V_{IN} = 3.0V$ ,  $I_{OUT} = 0mA$ ,  $T_A = +25^\circ C$  unless otherwise specified.

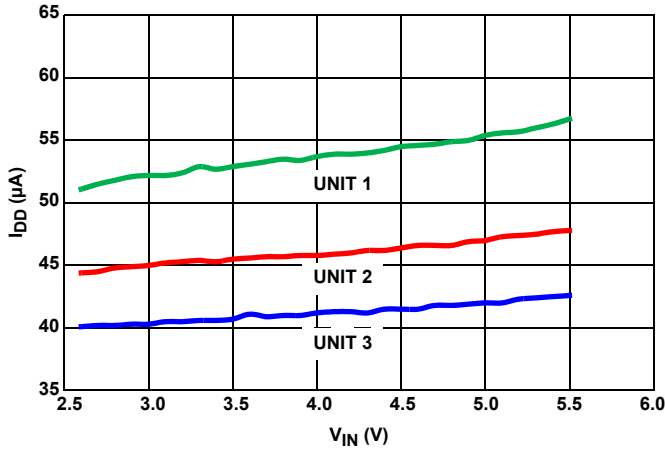

FIGURE 71.  $I_{IN}$  vs  $V_{IN}$ , THREE UNITS

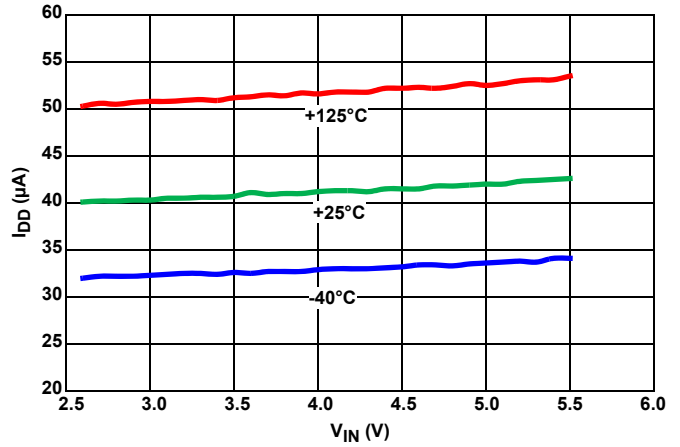

FIGURE 72.  $I_{IN}$  vs  $V_{IN}$ , OVER-TEMPERATURE

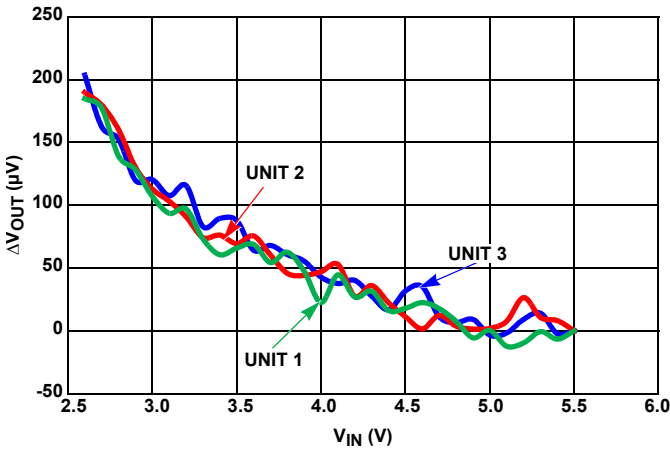

FIGURE 73. LINE REGULATION, THREE UNITS

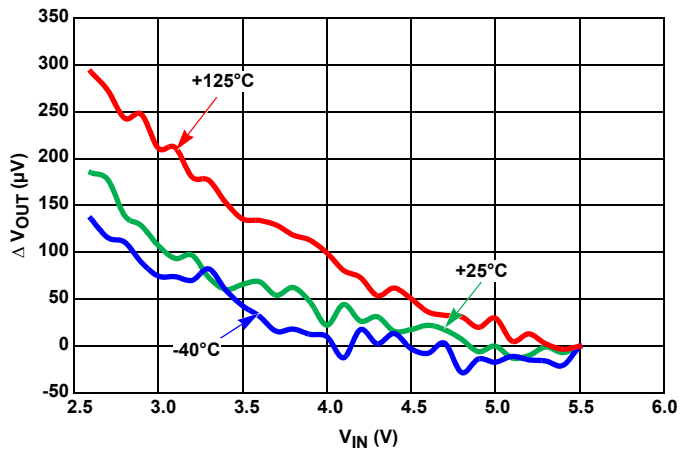

FIGURE 74. LINE REGULATION OVER-TEMPERATURE

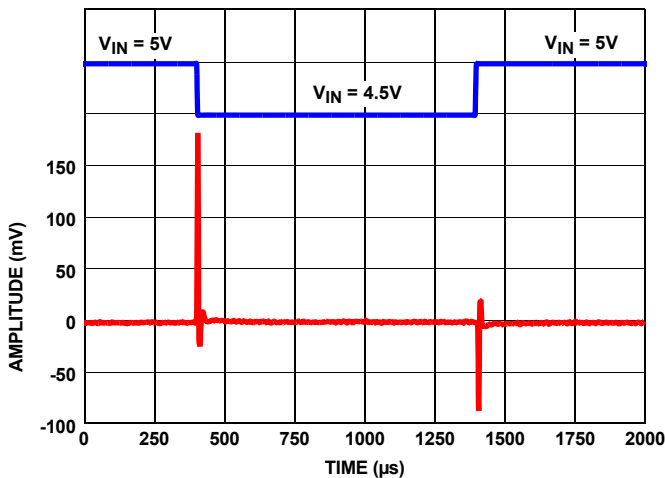

FIGURE 75. LINE TRANSIENT RESPONSE WITH  $0.1\mu F$  LOAD

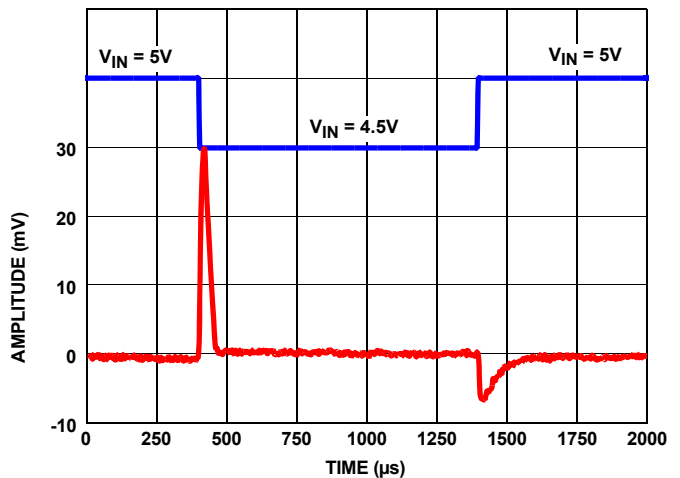

FIGURE 76. LINE TRANSIENT RESPONSE WITH  $10\mu F$  LOAD

# Typical Performance Characteristics Curves ( $V_{OUT} = 2.5V$ )

$V_{IN} = 3.0V$ ,  $I_{OUT} = 0mA$ ,  $T_A = +25^\circ C$  unless otherwise specified. (Continued)

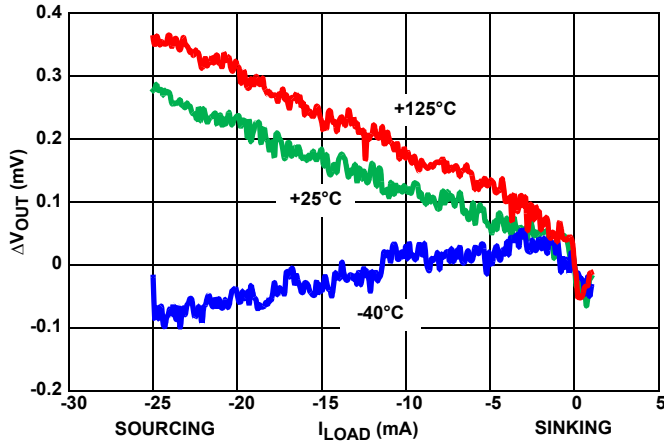

FIGURE 77. LOAD REGULATION OVER-TEMPERATURE

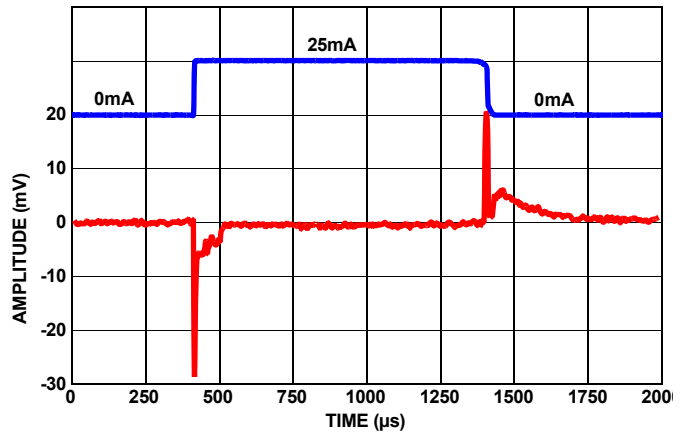

FIGURE 78. LOAD TRANSIENT RESPONSE AT 25mA LOAD AT 1μF

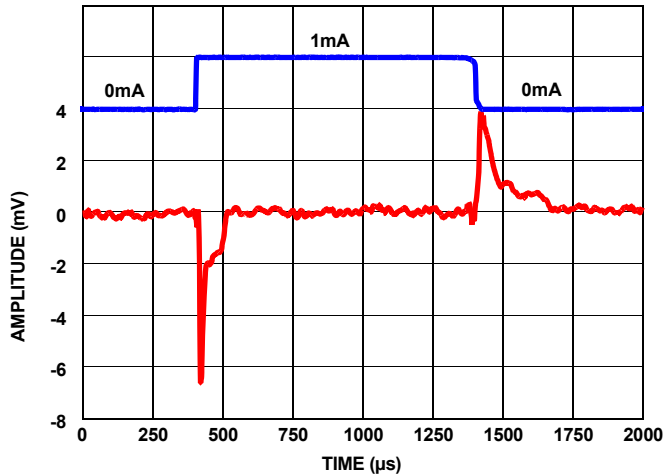

FIGURE 79. LOAD TRANSIENT RESPONSE AT 1mA LOAD AT 1μF

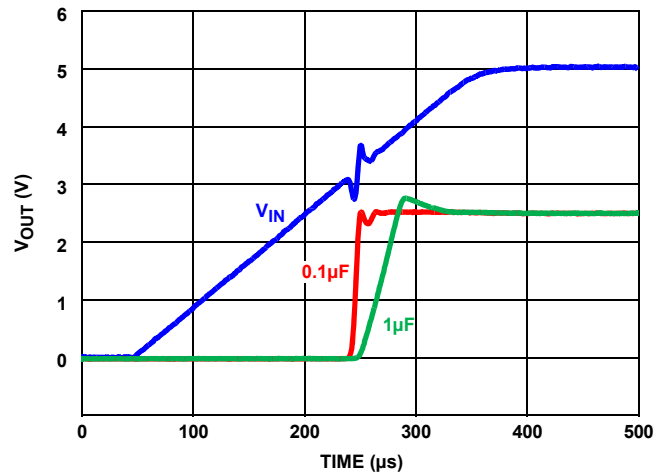

FIGURE 80. TURN-ON TIME

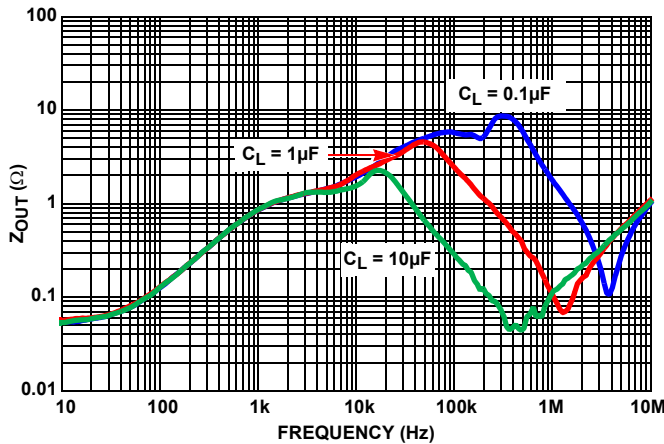

FIGURE 81.  $Z_{OUT}$  vs FREQUENCY

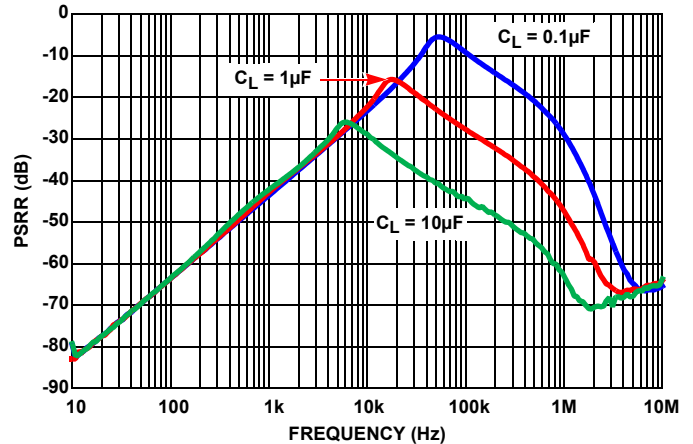

FIGURE 82. RIPPLE REJECTION AT DIFFERENT CAPACITIVE LOADS

# Typical Performance Characteristics Curves ( $V_{OUT} = 2.5V$ )

$V_{IN} = 3.0V$ ,  $I_{OUT} = 0mA$ ,  $T_A = +25^\circ C$  unless otherwise specified. (Continued)

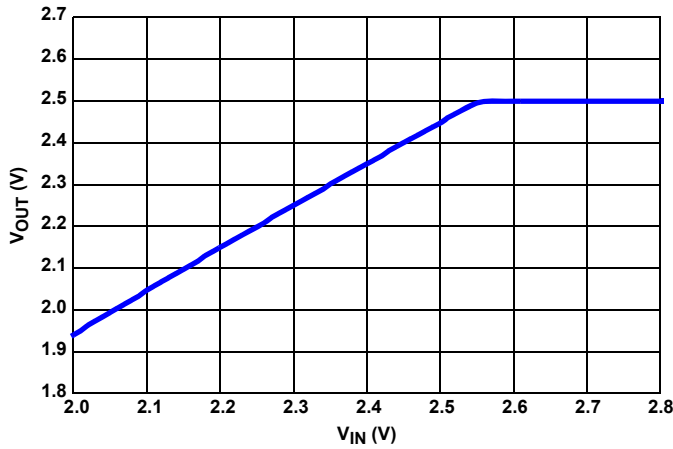

FIGURE 83. DROPOUT (10mA SOURCED LOAD)

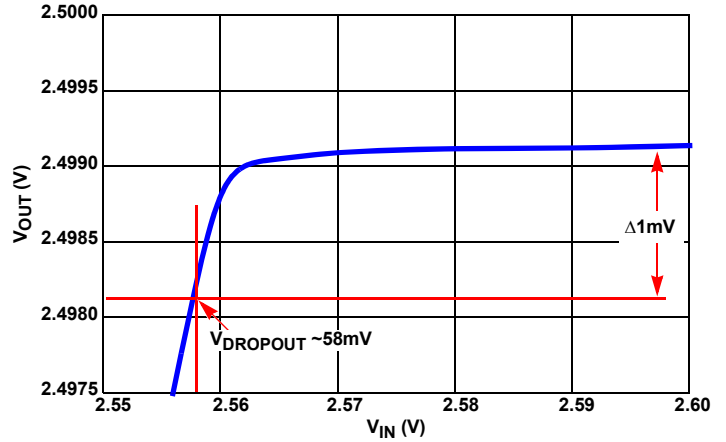

FIGURE 84. DROPOUT ZOOMED (10mA SOURCED LOAD)

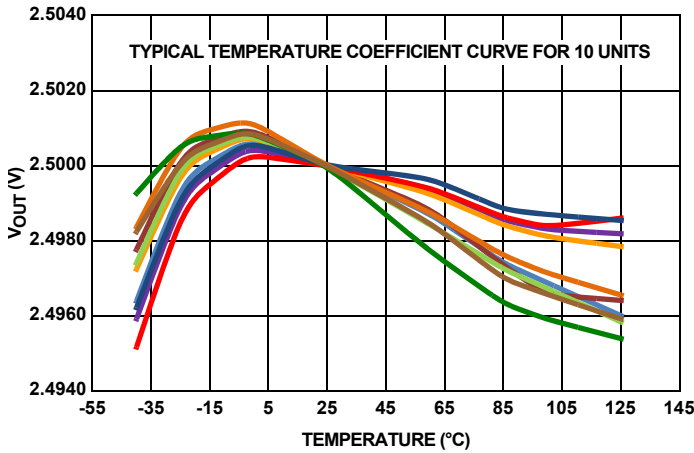

FIGURE 85.  $V_{OUT}$  vs TEMPERATURE

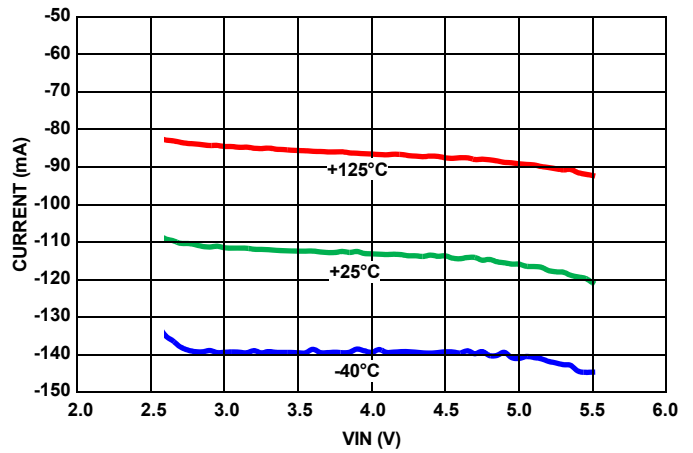

FIGURE 86. SHORT-CIRCUIT TO GND

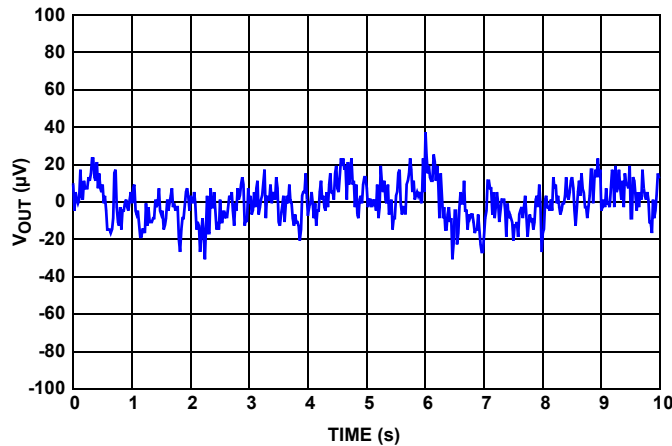

FIGURE 87.  $V_{OUT}$  vs NOISE, 0.1Hz TO 10Hz



## Typical Performance Characteristics Curves ( $V_{OUT} = 3.0V$ )

$V_{IN} = 5.0V$ ,  $I_{OUT} = 0mA$ ,  $T_A = +25^\circ C$  unless otherwise specified.

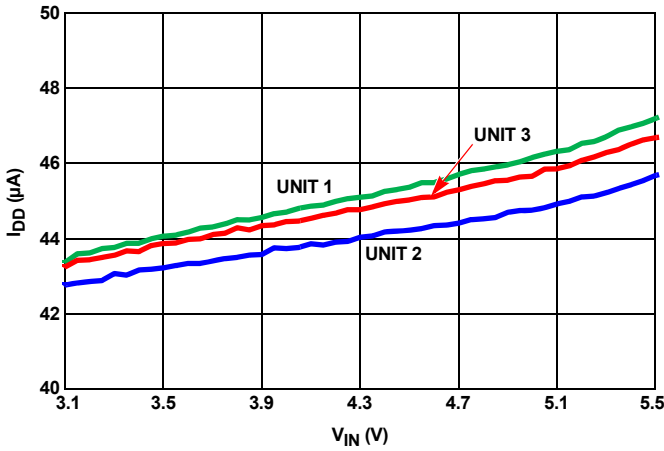

FIGURE 88.  $I_{IN}$  vs  $V_{IN}$ , THREE UNITS

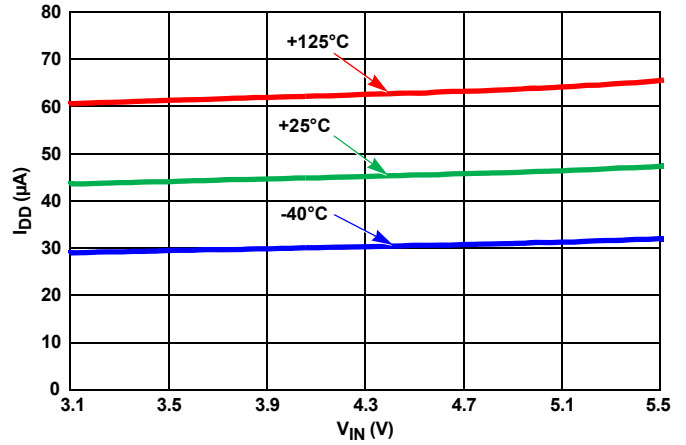

FIGURE 89.  $I_{IN}$  vs  $V_{IN}$ , OVER-TEMPERATURE

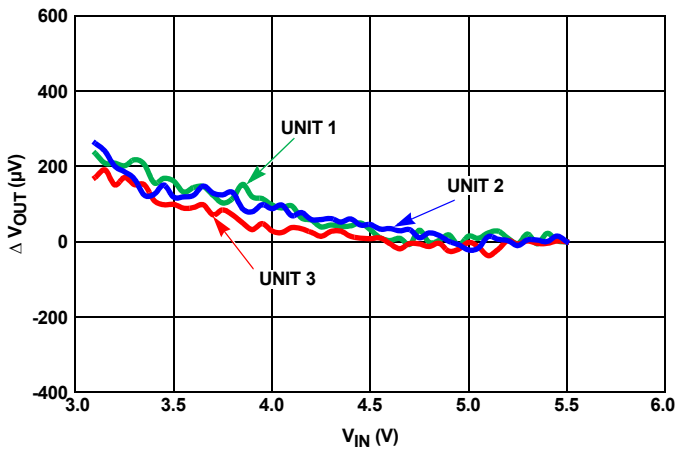

FIGURE 90. LINE REGULATION, THREE UNITS

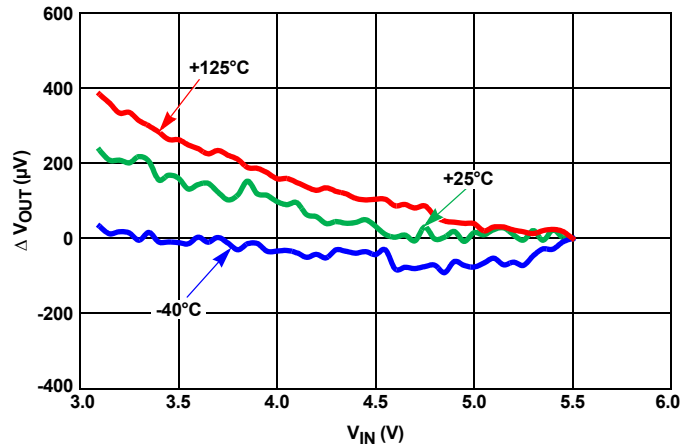

FIGURE 91. LINE REGULATION OVER-TEMPERATURE

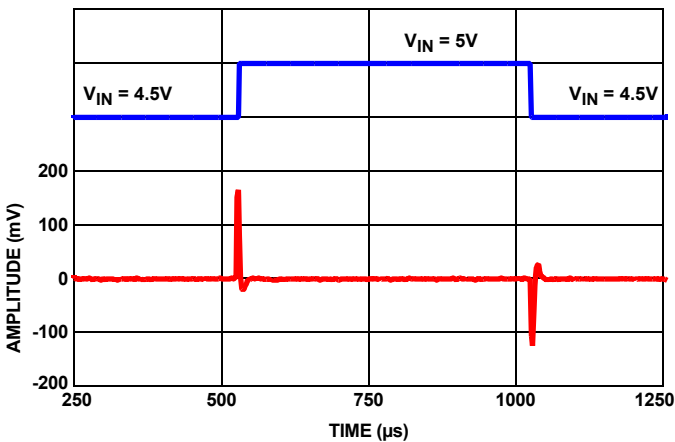

FIGURE 92. LINE TRANSIENT WITH  $0.1\mu F$  LOAD

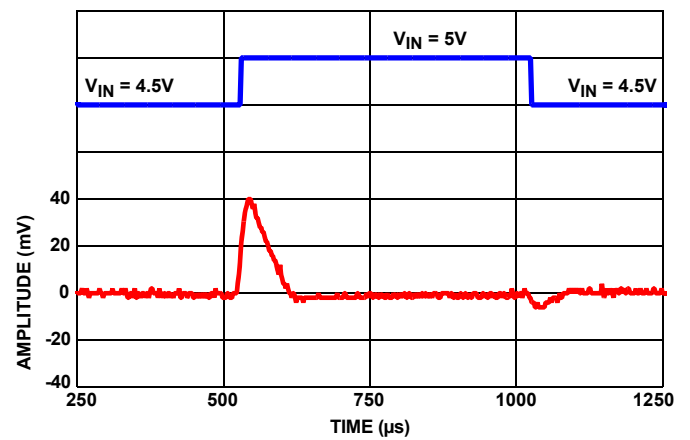

FIGURE 93. LINE TRANSIENT RESPONSE WITH  $10\mu F$  LOAD

## Typical Performance Characteristics Curves ( $V_{OUT} = 3.0V$ )

$V_{IN} = 5.0V$ ,  $I_{OUT} = 0mA$ ,  $T_A = +25^\circ C$  unless otherwise specified. (Continued)

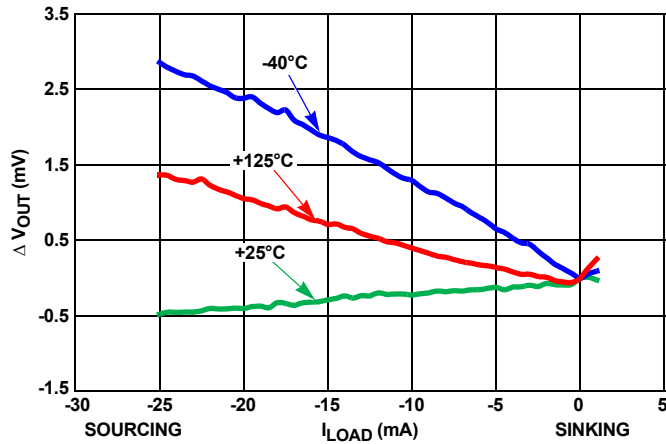

FIGURE 94. LOAD REGULATION OVER-TEMPERATURE

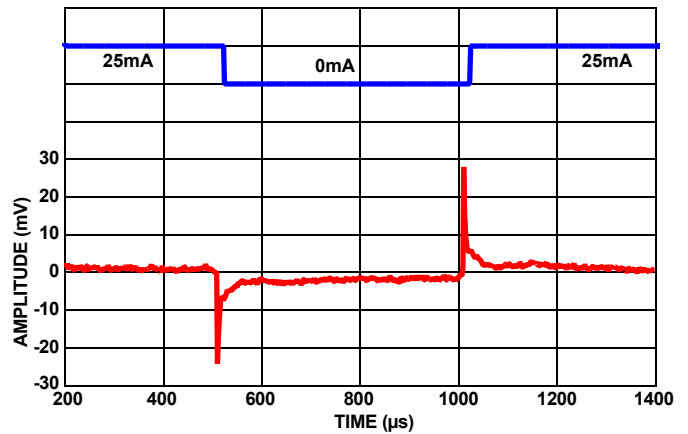

FIGURE 95. LOAD TRANSIENT RESPONSE AT 25mA LOAD AT  $1\mu F$

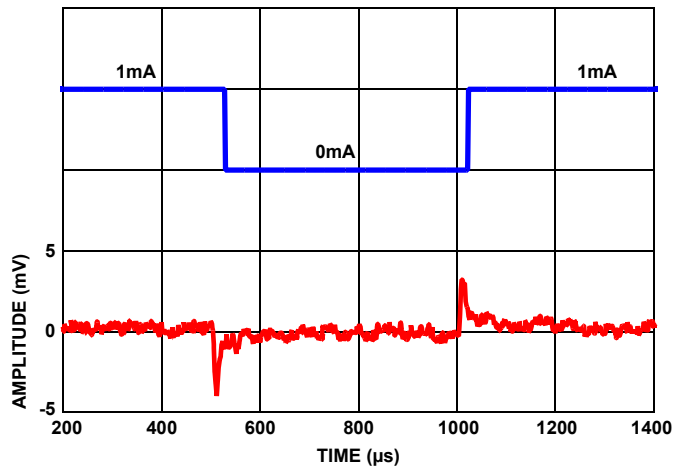

FIGURE 96. LOAD TRANSIENT RESPONSE AT 1mA LOAD AT  $1\mu F$

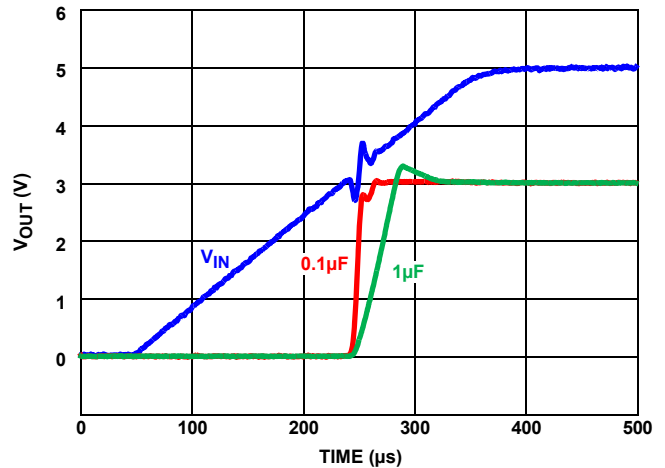

FIGURE 97. TURN-ON TIME

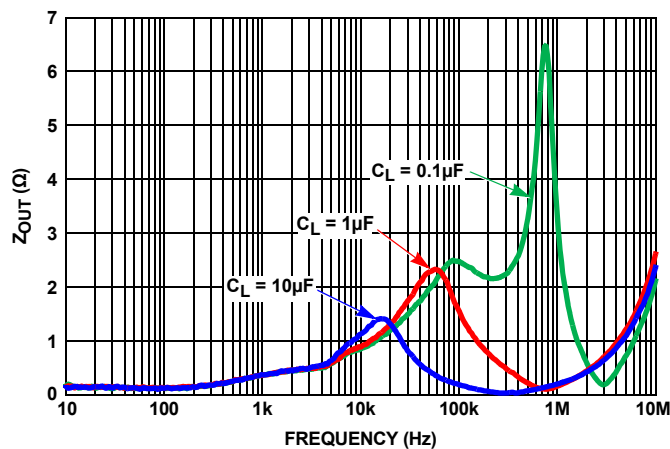

FIGURE 98.  $Z_{OUT}$  vs FREQUENCY

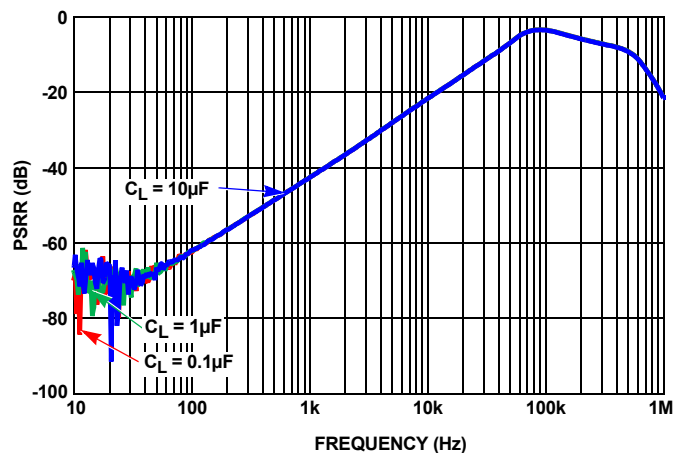

FIGURE 99. RIPPLE REJECTION AT DIFFERENT CAPACITIVE LOADS

## Typical Performance Characteristics Curves ( $V_{OUT} = 3.0V$ )

$V_{IN} = 5.0V$ ,  $I_{OUT} = 0mA$ ,  $T_A = +25^\circ C$  unless otherwise specified. (Continued)

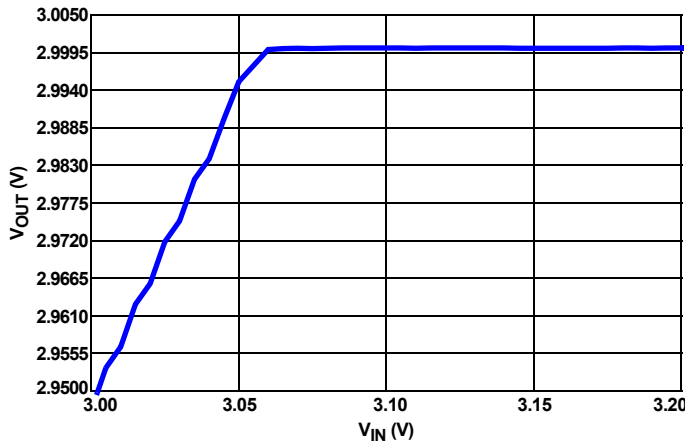

FIGURE 100. DROPOUT (10mA SOURCED LOAD)

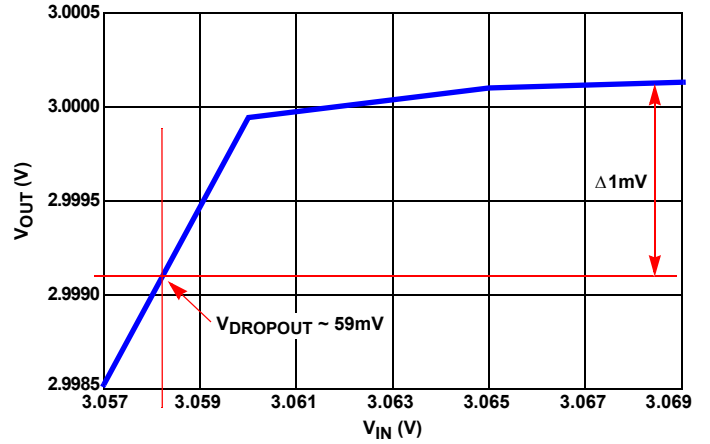

FIGURE 101. DROPOUT ZOOMED (10mA SOURCED LOAD)

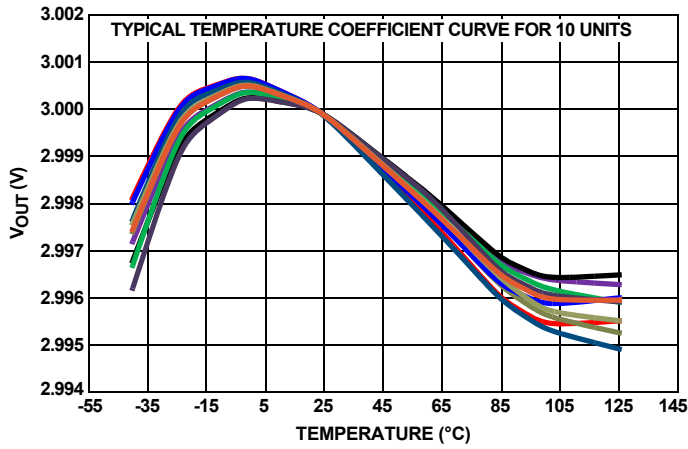

FIGURE 102.  $V_{OUT}$  vs TEMPERATURE

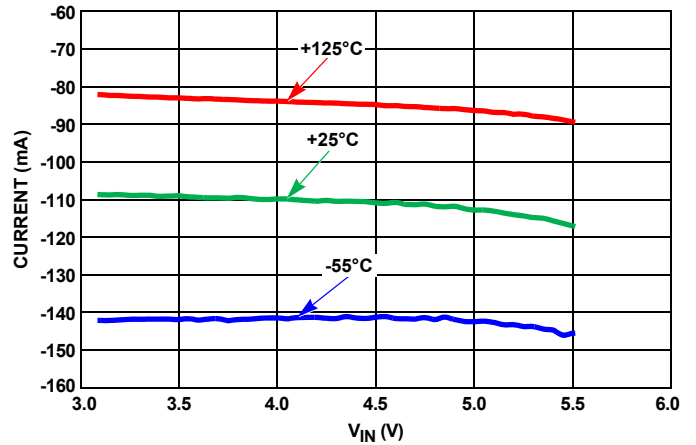

FIGURE 103. SHORT-CIRCUIT TO GND

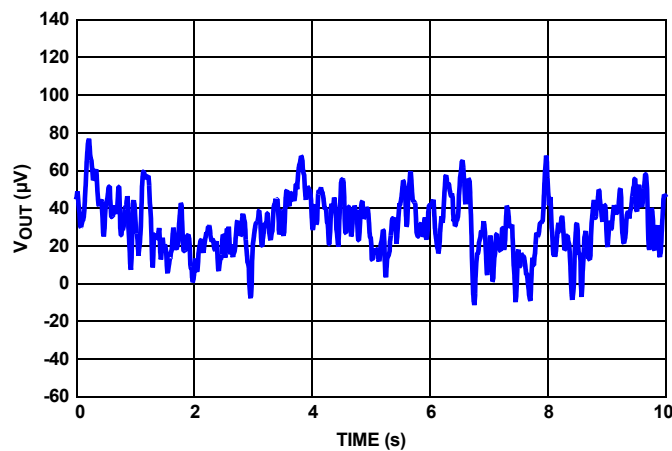

FIGURE 104.  $V_{OUT}$  vs NOISE, 0.1Hz TO 10Hz

## Typical Performance Characteristics Curves ( $V_{OUT} = 3.3V$ )

$V_{IN} = 5.0V$ ,  $I_{OUT} = 0mA$ ,  $T_A = +25^\circ C$  unless otherwise specified.

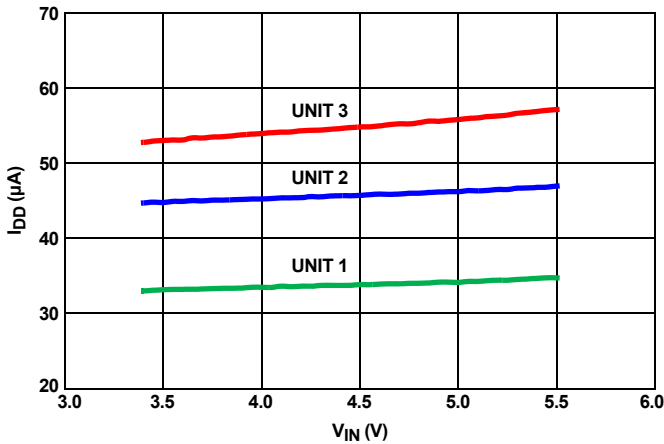

FIGURE 105.  $I_{IN}$  vs  $V_{IN}$ , THREE UNITS

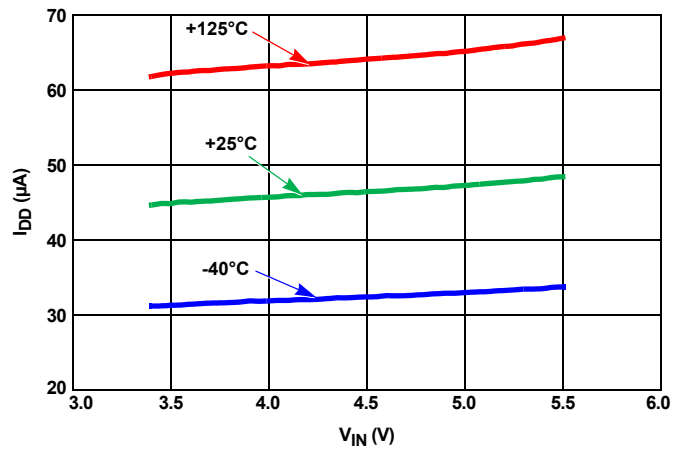

FIGURE 106.  $I_{IN}$  vs  $V_{IN}$ , OVER-TEMPERATURE

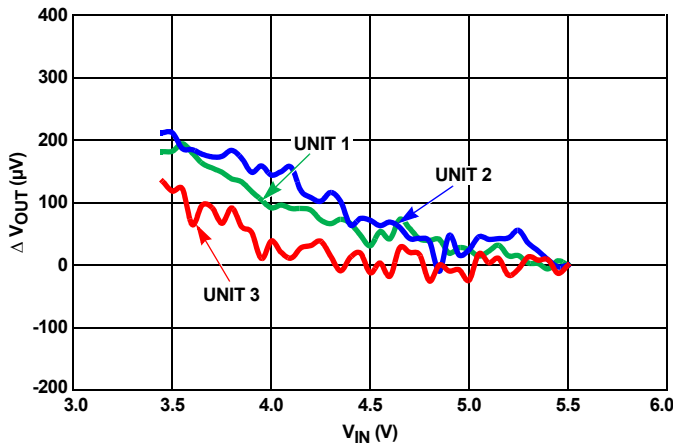

FIGURE 107. LINE REGULATION, THREE UNITS

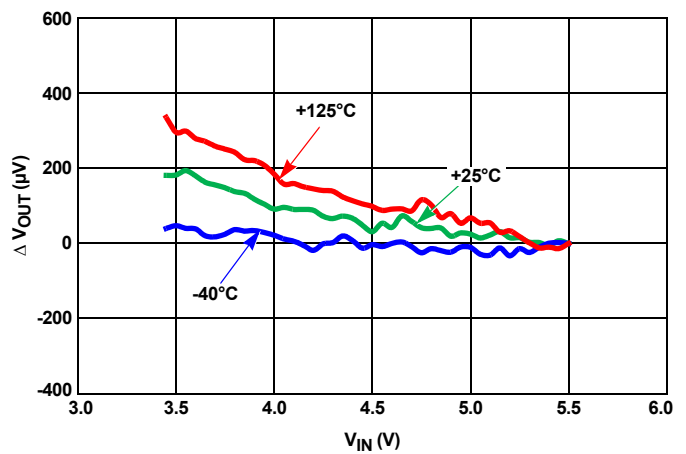

FIGURE 108. LINE REGULATION OVER-TEMPERATURE

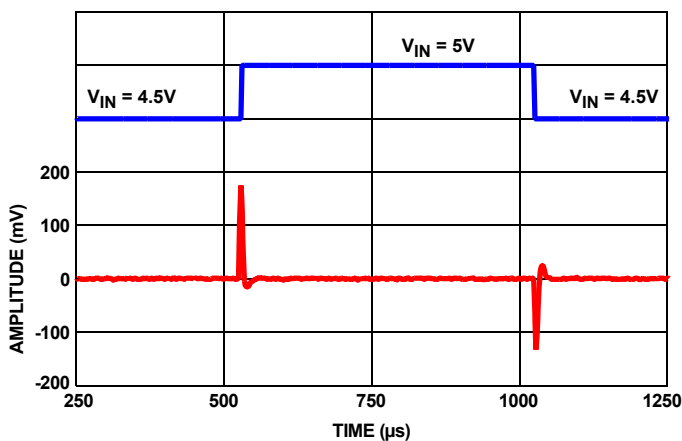

FIGURE 109. LINE TRANSIENT WITH  $0.1\mu F$  LOAD

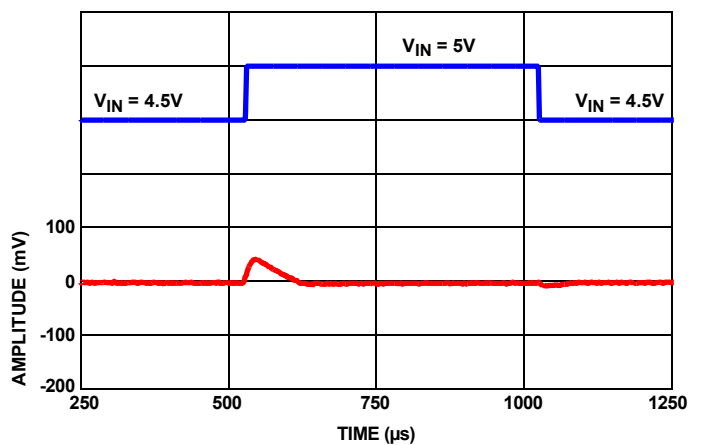

FIGURE 110. LINE TRANSIENT RESPONSE WITH  $10\mu F$  LOAD

# Typical Performance Characteristics Curves ( $V_{OUT} = 3.3V$ )

$V_{IN} = 5.0V$ ,  $I_{OUT} = 0mA$ ,  $T_A = +25^\circ C$  unless otherwise specified. (Continued)

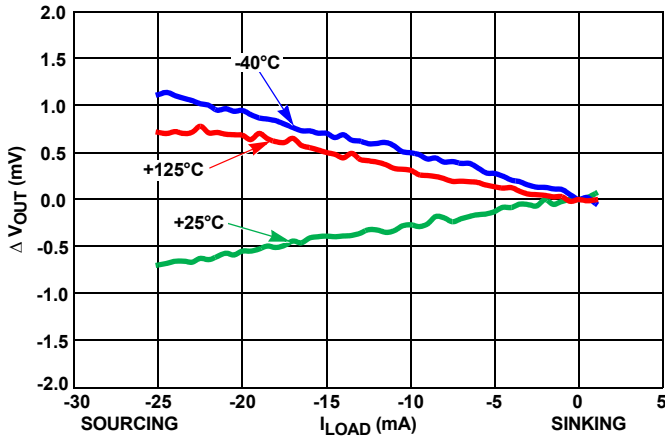

FIGURE 111. LOAD REGULATION OVER-TEMPERATURE

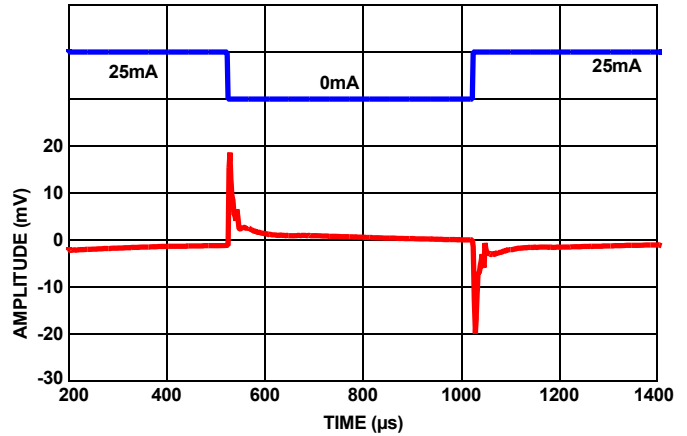

FIGURE 112. LOAD TRANSIENT RESPONSE AT 25mA LOAD AT 1μF

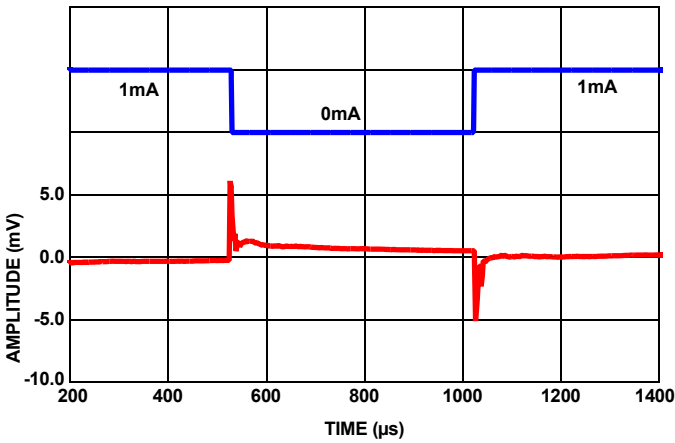

FIGURE 113. LOAD TRANSIENT RESPONSE AT 1mA LOAD AT 1μF

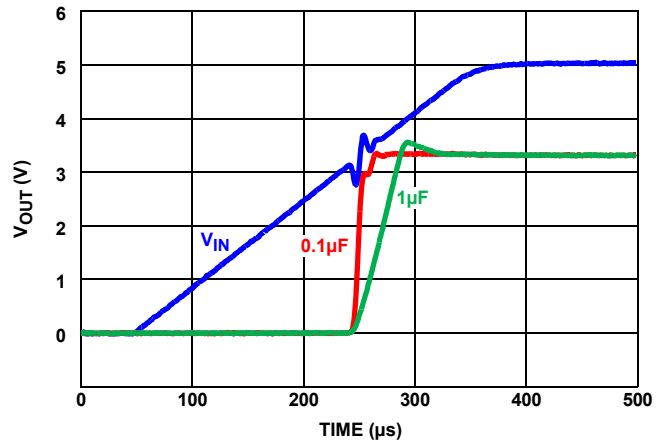

FIGURE 114. TURN-ON TIME

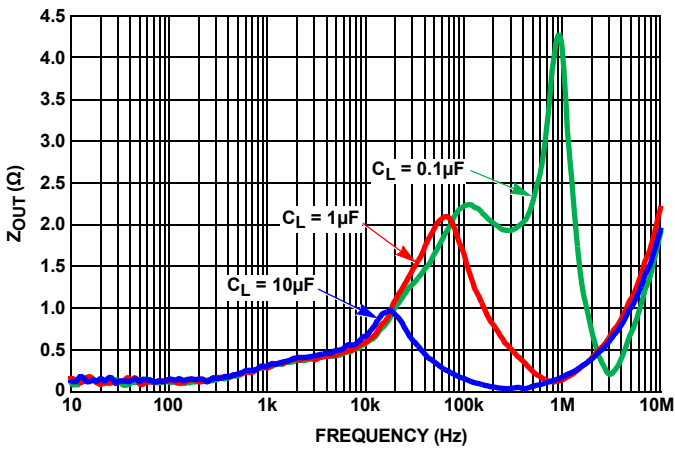

FIGURE 115.  $Z_{OUT}$  vs FREQUENCY

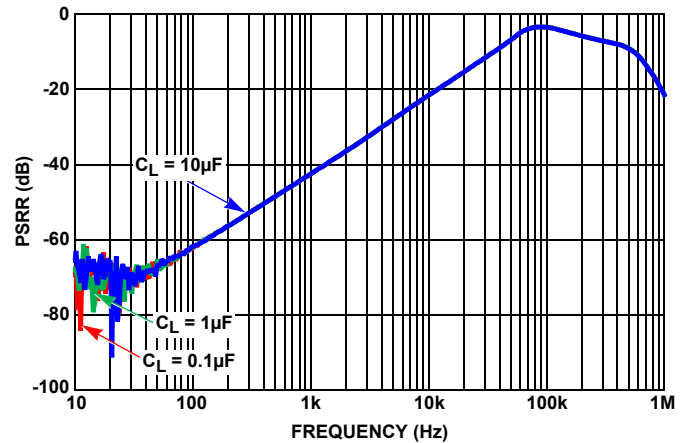

FIGURE 116. RIPPLE REJECTION AT DIFFERENT CAPACITIVE LOADS

## Typical Performance Characteristics Curves ( $V_{OUT} = 3.3V$ )

$V_{IN} = 5.0V$ ,  $I_{OUT} = 0mA$ ,  $T_A = +25^\circ C$  unless otherwise specified. (Continued)

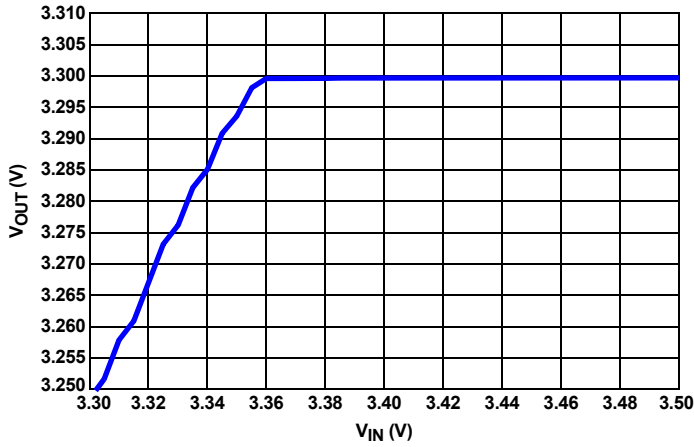

FIGURE 117. DROPOUT (10mA SOURCED LOAD)

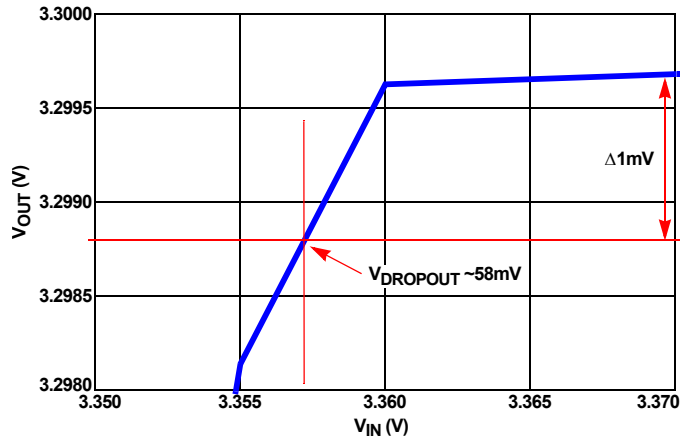

FIGURE 118. DROPOUT ZOOMED (10mA SOURCED LOAD)

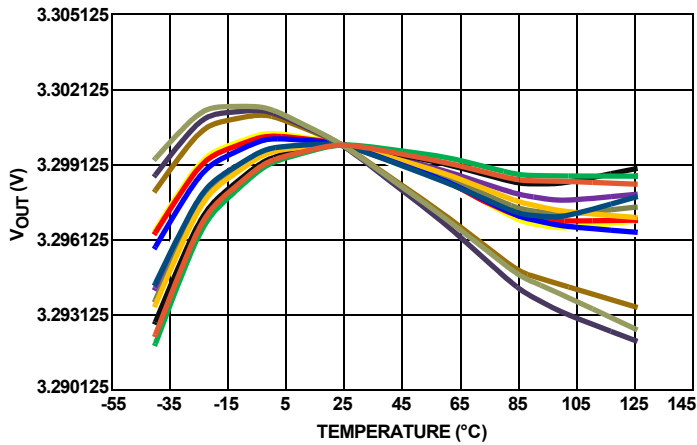

FIGURE 119.  $V_{OUT}$  vs TEMPERATURE

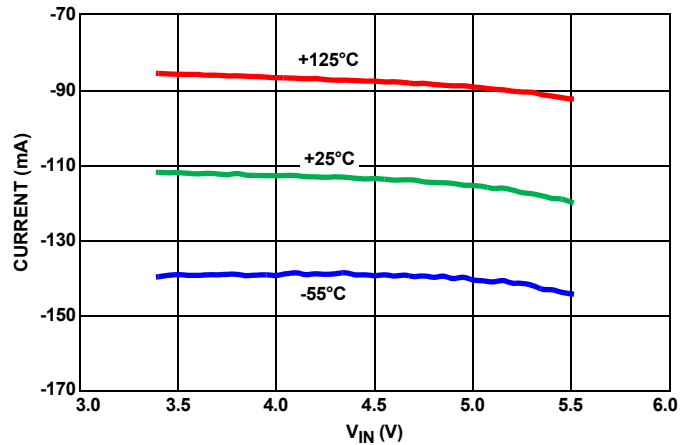

FIGURE 120. SHORT-CIRCUIT TO GND

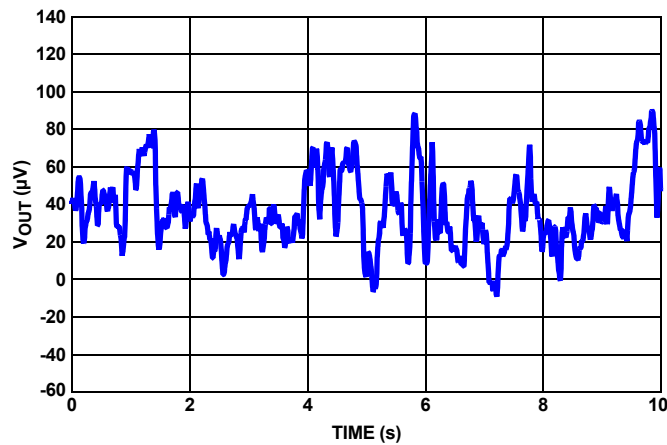

FIGURE 121.  $V_{OUT}$  vs NOISE, 0.1Hz TO 10Hz

# Typical Performance Characteristics Curves ( $V_{OUT} = 4.096V$ )

$V_{IN} = 3.0V$ ,  $I_{OUT} = 0mA$ ,  $T_A = +25^\circ C$  unless otherwise specified.

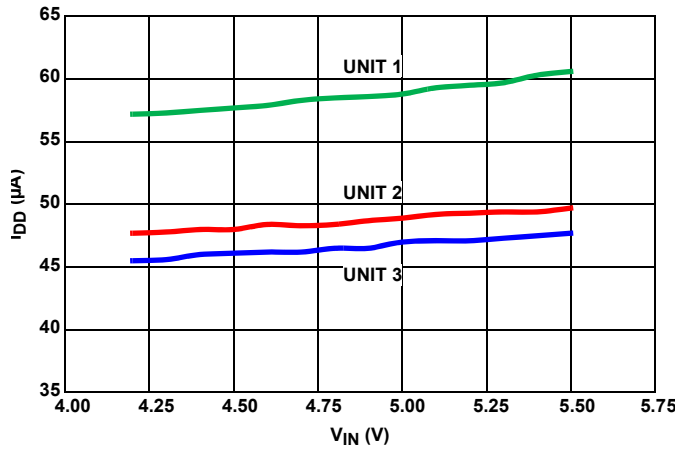

FIGURE 122.  $I_{DD}$  vs  $V_{IN}$ , THREE UNITS

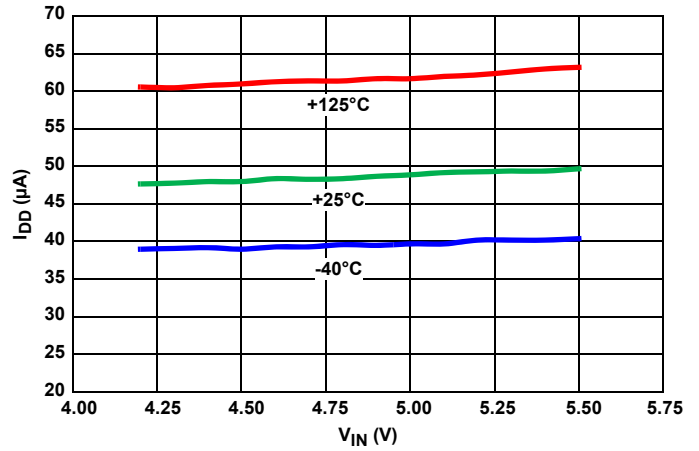

FIGURE 123.  $I_{DD}$  vs  $V_{IN}$ , OVER-TEMPERATURE

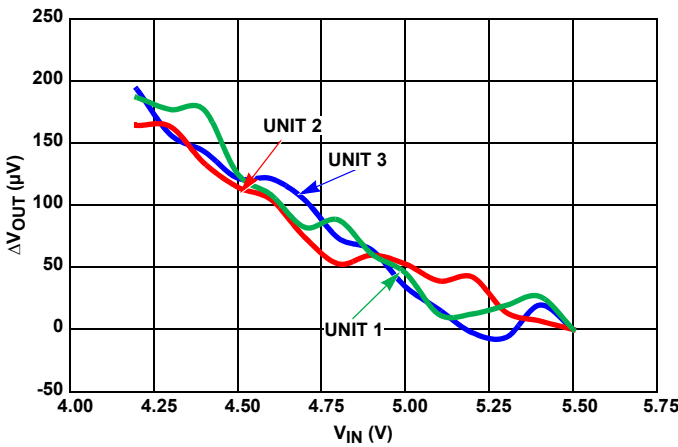

FIGURE 124. LINE REGULATION, THREE UNITS

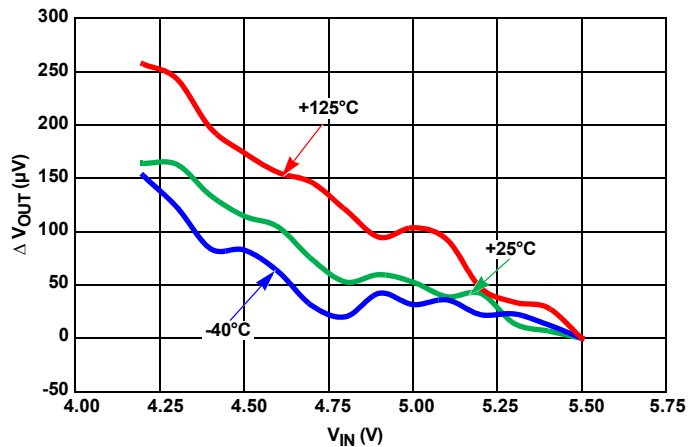

FIGURE 125. LINE REGULATION OVER-TEMPERATURE

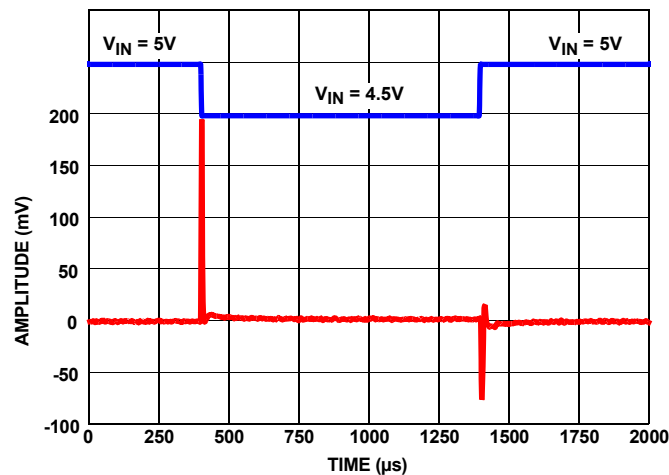

FIGURE 126. LINE TRANSIENT RESPONSE WITH  $0.1\mu F$  LOAD

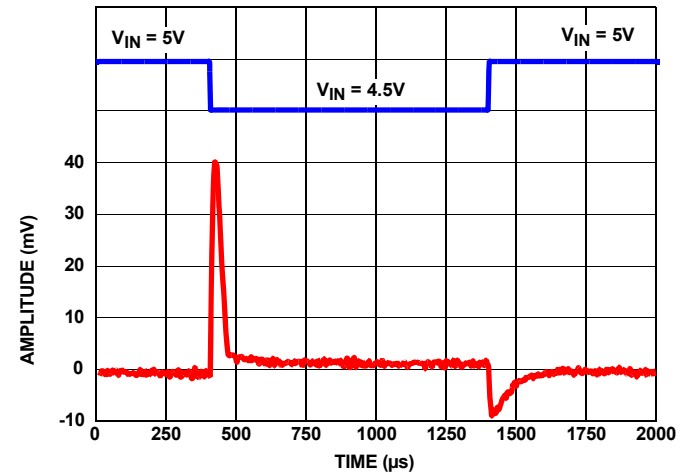

FIGURE 127. LINE TRANSIENT RESPONSE WITH  $10\mu F$  LOAD

# Typical Performance Characteristics Curves ( $V_{OUT} = 4.096V$ )

$V_{IN} = 3.0V$ ,  $I_{OUT} = 0mA$ ,  $T_A = +25^\circ C$  unless otherwise specified. (Continued)

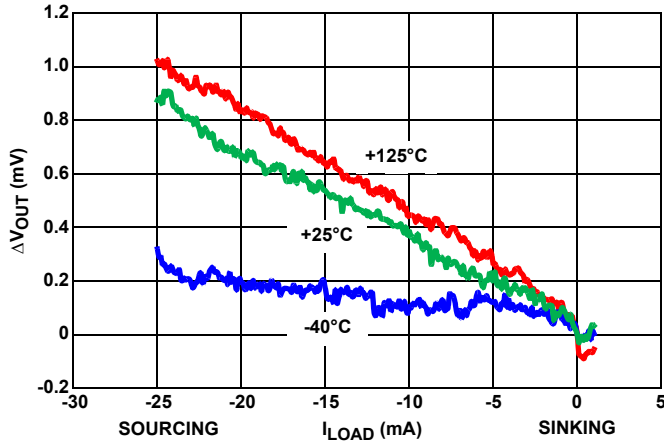

FIGURE 128. LOAD REGULATION OVER-TEMPERATURE

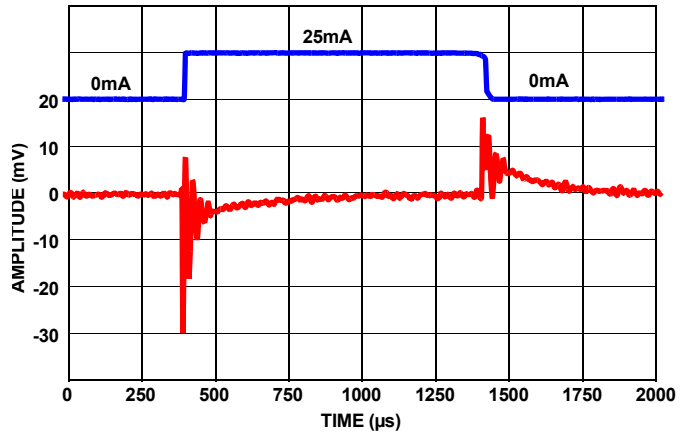

FIGURE 129. LOAD TRANSIENT RESPONSE AT 25mA LOAD AT 1μF

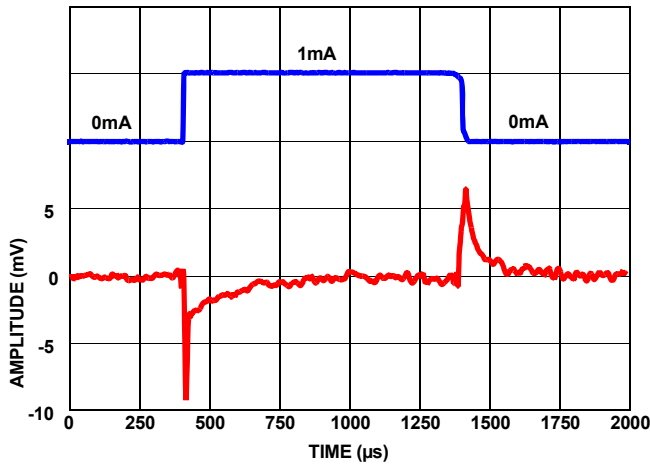

FIGURE 130. LOAD TRANSIENT RESPONSE AT 1mA LOAD AT 1μF

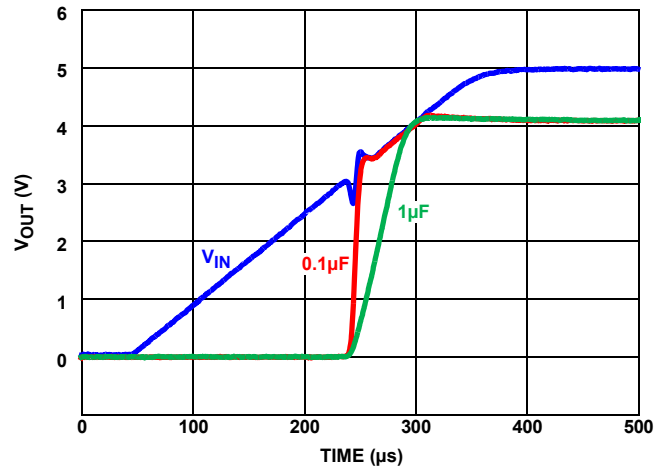

FIGURE 131. TURN-ON TIME

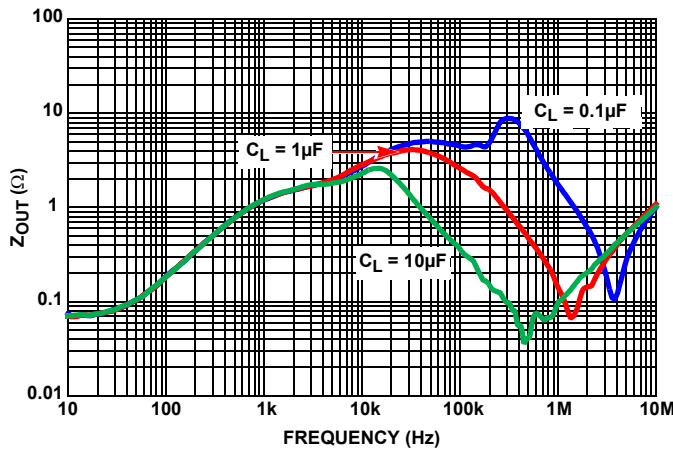

FIGURE 132.  $Z_{OUT}$  vs FREQUENCY

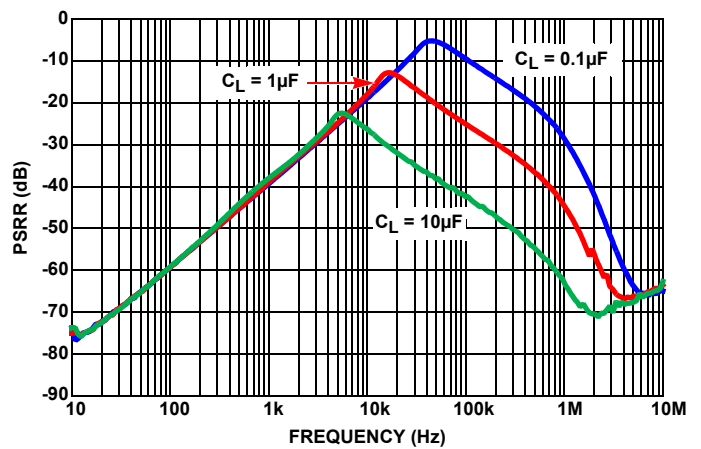

FIGURE 133. RIPPLE REJECTION AT DIFFERENT CAPACITIVE LOADS



# Typical Performance Characteristics Curves ( $V_{OUT} = 4.096V$ )

$V_{IN} = 3.0V$ ,  $I_{OUT} = 0mA$ ,  $T_A = +25^\circ C$  unless otherwise specified. (Continued)

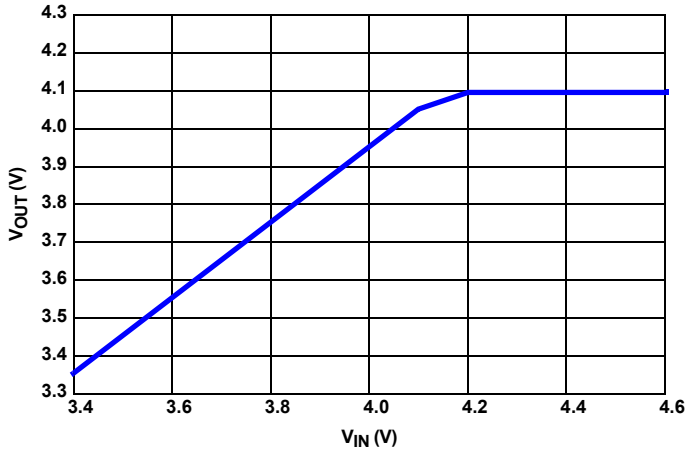

FIGURE 134. DROPOUT (10mA SOURCED LOAD)

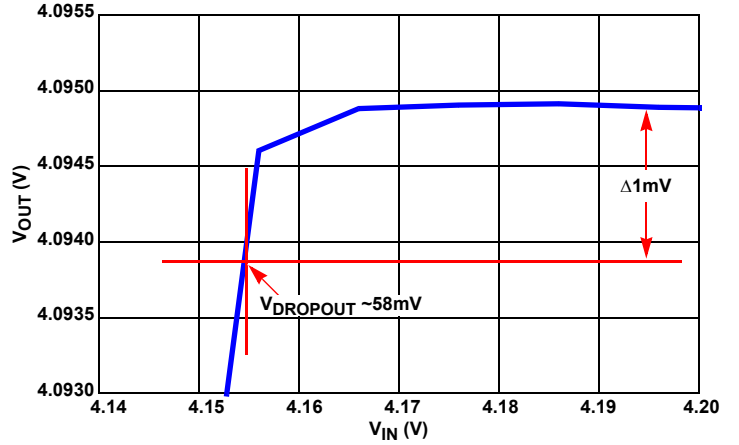

FIGURE 135. DROPOUT ZOOMED (10mA SOURCED LOAD)

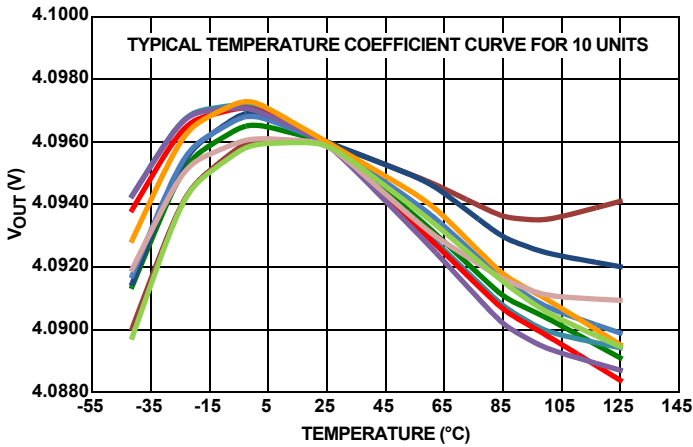

FIGURE 136.  $V_{OUT}$  vs TEMPERATURE

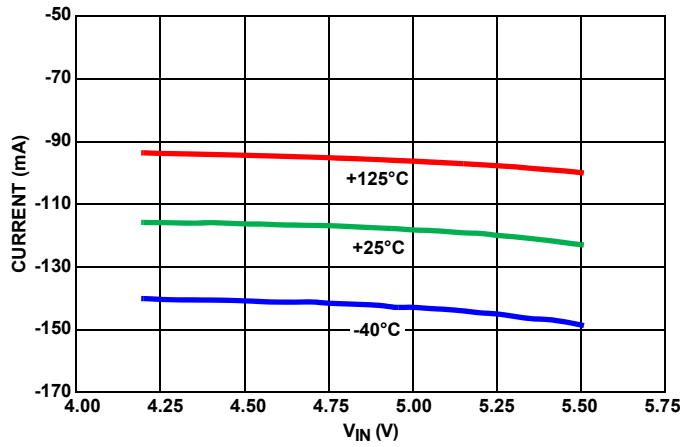

FIGURE 137. SHORT-CIRCUIT TO GND

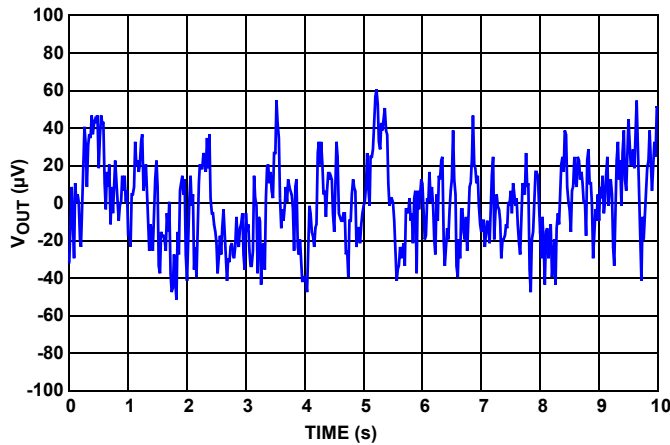

FIGURE 138.  $V_{OUT}$  vs NOISE, 0.1Hz TO 10Hz

## Applications Information

### Micropower Operation

The ISL21010 consumes very low supply current due to the proprietary bandgap technology. Low noise performance is achieved using optimized biasing techniques. Supply current is typically 48 $\mu$ A and noise in the 0.1Hz to 10Hz bandwidth is 58 $\mu$ V<sub>P-P</sub> to 100 $\mu$ V<sub>P-P</sub> ( $V_{OUT}$  = 2.048V, 3.0V, and 3.3V) benefiting precision, low noise portable applications such as handheld meters and instruments.

Data converters in particular can use the ISL21010 as an external voltage reference. Low power DAC and ADC circuits achieve maximum resolution with lowest noise. The ISL21010 maintains output voltage during conversion cycles with fast response, although it is helpful to add an output capacitor, typically 1 $\mu$ F.

### Board Mounting Considerations

For applications requiring the highest accuracy, review the board mounting location. The ISL21010 uses a plastic SOIC package, which subjects the die to mild stresses when the Printed Circuit Board (PCB) is heated and cooled and slightly changes the shape. Placing the device in areas subject to slight twisting degrades the accuracy of the reference voltage due to these die stresses. It is normally best to place the device near the edge of a board, or on the shortest side because the axis of bending is most limited at that location. Mounting the device in a cutout also minimizes flex. Mounting the device on flexprint or extremely thin PCB material causes reference accuracy loss.

### Board Assembly Considerations

Bandgap references provide high accuracy and low temperature drift but some PCB assembly precautions are necessary. Normal output voltage shifts of 100 $\mu$ V to 4mV can be expected with Pb-free reflow profiles or wave solder on multilayer FR4 PCBs. Avoid excessive heat or extended exposure to high reflow or wave solder temperatures; this can reduce device initial accuracy.

### Noise Performance and Reduction

The recommended capacitive load range for the ISL21010 is from 0.1 $\mu$ F to 10.0 $\mu$ F (0.22 $\mu$ F minimum required for 1.024V option) to ensure stability and best transient performance. Parallel 0.1 $\mu$ F (0.22 $\mu$ F for 1.024V) and 10 $\mu$ F capacitors can be used to optimize performance as well. The noise specification stated in the Electrical Specification tables (starting on [page 5](#)) is for 0.1 $\mu$ F (0.22 $\mu$ F for 1.024V option) capacitive load. Larger values reduce the output noise level.

## Revision History

The revision history provided is for informational purposes only and is believed to be accurate, but not warranted. Please visit our website to make sure you have the latest revision.

DATE	REVISION	CHANGE
Sep 20, 2021	7.00	Updated Links Updated Ordering Information table formatting. Removed Cycling $V_{IN}$ On-Off-On (CAUTION) section on page 34.
Apr 19, 2019	6.00	Added Cycling $V_{IN}$ On-Off-On (CAUTION) section on page 34. Updated disclaimer.
Mar 30, 2018	5.00	Updated Related Literature section. Added new parts and updated notes in the Ordering Information table on page 4. Removed About Intersil section and updated disclaimer.
Feb 12, 2016	4.00	Removed DAQ on a stick reference from "Related Literature" on page 1. Updated "Ordering Information" on page 4 by adding column for tape and reel option. Updated HBM value to kV (5500V to 5.5kV) in "Absolute Maximum Ratings" on page 5.
Jan 8, 2015	3.00	On page 1, in the Related Literature section added AN1853 and AN1883. On page 4, updated the ordering information table by adding the (-7TA) products. Changed the y-axis units on Figure 19 on page 12 from "(V)" to "( $\mu$ V)".
Jun 23, 2014	2.00	Added Curves for Voltage Refs 1.25V, 1.024V, 1.5V, 2.5V and 4.096V Updated POD with following changes: In Detail A, changed lead width dimension from 0.13+/-0.05 to 0.085-0.19 Changed dimension of foot of lead from 0.31+/-0.10 to 0.38+/-0.10 In Land Pattern, added 0.4 Rad Typ dimension In Side View, changed height of package from 0.91+/-0.03 to 0.95+/-0.07
Nov 28, 2011	1.00	On page 1, Features: removed "Coming Soon" from ISL21010-10, -12, -15; ISL21010-25; and ISL21010-40 voltage options; combined -20 option with -10, -12, -15; changed -40 to -41 On page 4, Ordering Information: added parts ISL21010DFH310Z-TK, ISL21010DFH312Z-TK, ISL21010CFH315Z-TK, ISL21010CFH325Z-TK, ISL21010CFH341Z-TK On page 5, Recommended Operating Conditions: added $V_{OUT} = 1.024V, 1.25V, 1.5V, 2.048V, 2.2V$ to 5.5V; $V_{OUT} = 2.5V, \dots, 2.6V$ to 5.5V; $V_{OUT} = 4.096V, \dots, 4.2V$ to 5.5V On page 5 through page 9, added Electrical Specifications tables for (ISL21010-10, $V_{OUT} = 1.024V$ ), (ISL21010-12, $V_{OUT} = 1.25V$ ), (ISL21010-15, $V_{OUT} = 1.5V$ ), (ISL21010-41, $V_{OUT} = 4.096V$ ) On page 7, Electrical Specifications (ISL21010-20, $V_{OUT} = 2.048V$ ): changed $V_{OUT}/T_A$ , Thermal Hysteresis, TYP from 50 to 100 On page 9, Note 9: changed "... where $V_{OUT}$ drops 1mV from $V_{IN} = 5.0V$ at $T_A = +25^\circ C$ ." to "... where $V_{OUT}$ drops 1mV from $V_{IN} = \text{nominal}$ at $T_A = +25^\circ C$ ." On page 26, Figure 95, changed title from "LOAD REGULATION OVER-TEMPERATURE" to "LOAD TRANSIENT RESPONSE AT 25mA LOAD". Figure 27, changed title from "LOAD TRANSIENT RESPONSE" to "LOAD TRANSIENT RESPONSE AT 1mA LOAD". On page 27, Figure 100, and page 30, Figure 117, changed figure titles to indicate 10mA instead of 1mA source load. On page 29, Figure 112, changed title from LOAD REGULATION OVER-TEMPERATURE" to "LOAD TRANSIENT RESPONSE AT 25mA LOAD". Figure 113, changed title from "LOAD TRANSIENT RESPONSE" to "LOAD TRANSIENT RESPONSE AT 1mA LOAD" On page 34, under "Noise Performance and Reduction", added reference to capacitive load range for 1.024V option.
Aug 9, 2011	0.00	Initial Release

# Package Outline Drawing

For the most recent package outline drawing, see [P3.064](#).

P3.064

3 Lead Small Outline Transistor Plastic Package (SOT23-3)

Rev 3, 3/12

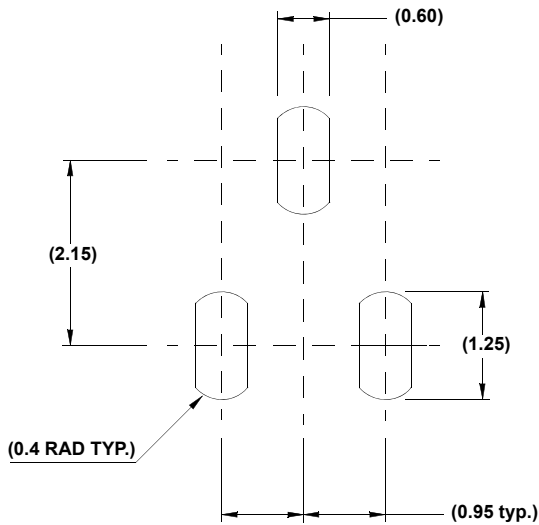
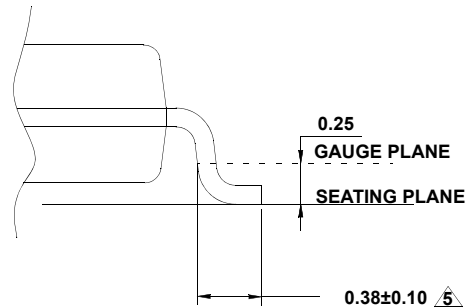
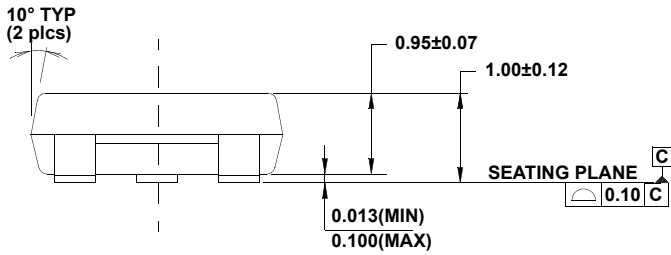
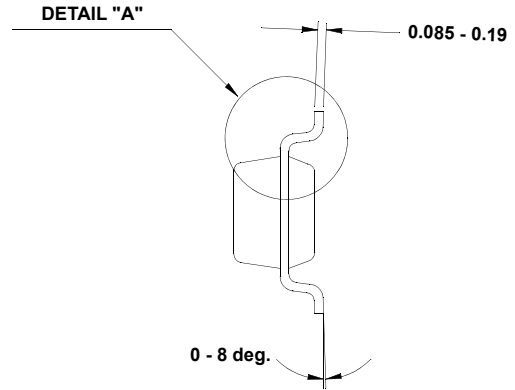
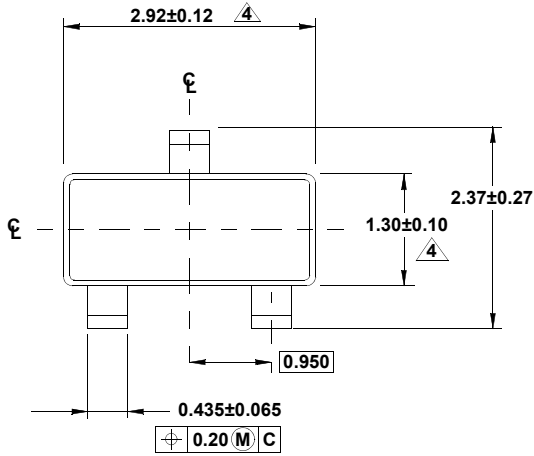

NOTES:

1. Dimensions are in millimeters. Dimensions in ( ) for Reference Only.
2. Dimensioning and tolerancing conform to AMSEY14.5m-1994.
3. Reference JEDEC TO-236.
4. Dimension does not include interlead flash or protrusions. Interlead flash or protrusions shall not exceed 0.25mm per side.
5. Footlength is measured at reference to gauge plane.

## IMPORTANT NOTICE AND DISCLAIMER

RENESAS ELECTRONICS CORPORATION AND ITS SUBSIDIARIES (“RENESAS”) PROVIDES TECHNICAL SPECIFICATIONS AND RELIABILITY DATA (INCLUDING DATASHEETS), DESIGN RESOURCES (INCLUDING REFERENCE DESIGNS), APPLICATION OR OTHER DESIGN ADVICE, WEB TOOLS, SAFETY INFORMATION, AND OTHER RESOURCES “AS IS” AND WITH ALL FAULTS, AND DISCLAIMS ALL WARRANTIES, EXPRESS OR IMPLIED, INCLUDING, WITHOUT LIMITATION, ANY IMPLIED WARRANTIES OF MERCHANTABILITY, FITNESS FOR A PARTICULAR PURPOSE, OR NON-INFRINGEMENT OF THIRD PARTY INTELLECTUAL PROPERTY RIGHTS.

These resources are intended for developers skilled in the art designing with Renesas products. You are solely responsible for (1) selecting the appropriate products for your application, (2) designing, validating, and testing your application, and (3) ensuring your application meets applicable standards, and any other safety, security, or other requirements. These resources are subject to change without notice. Renesas grants you permission to use these resources only for development of an application that uses Renesas products. Other reproduction or use of these resources is strictly prohibited. No license is granted to any other Renesas intellectual property or to any third party intellectual property. Renesas disclaims responsibility for, and you will fully indemnify Renesas and its representatives against, any claims, damages, costs, losses, or liabilities arising out of your use of these resources. Renesas' products are provided only subject to Renesas' Terms and Conditions of Sale or other applicable terms agreed to in writing. No use of any Renesas resources expands or otherwise alters any applicable warranties or warranty disclaimers for these products.

(Rev.1.0 Mar 2020)

### Corporate Headquarters

TOYOSU FORESIA, 3-2-24 Toyosu,  
Koto-ku, Tokyo 135-0061, Japan  
[www.renesas.com](http://www.renesas.com)

### Contact Information

For further information on a product, technology, the most up-to-date version of a document, or your nearest sales office, please visit:  
[www.renesas.com/contact/](http://www.renesas.com/contact/)

### Trademarks

Renesas and the Renesas logo are trademarks of Renesas Electronics Corporation. All trademarks and registered trademarks are the property of their respective owners.

单击下面可查看定价，库存，交付和生命周期等信息

[>>Renesas\(瑞萨\)](#)