

60V, 30μA I_Q, Low Dropout Voltage Linear Regulator

General Description

The RT9074 family are high voltage (60V operation), low quiescent current low dropout linear regulators capable of supplying 100mA of output current with a maximum dropout voltage of 400mV. The low quiescent and shutdown currents (30μA operating and 2μA shutdown) are ideal for use in battery-powered and/or high voltage systems. Ground current is well-controlled in all conditions, including dropout.

The RT9074 family operates with any reasonable output capacitors including 1μF low-ESR ceramic types and features excellent line and load transient responses. Internal protection circuitry includes reverse-battery protection, current limiting, thermal shutdown, and reverse current protection. Output voltage accuracy is ±3% over the entire line and load range.

These devices are available in 3 fixed-output versions (2.5V, 3.3V, 5V) as well as a version that supports an adjustable output voltage (1.23V to 60V). All versions come in SOP-8 package with an exposed pad for high power dissipation. The fixed output versions are also available packaged in SOT-223.

Features

- **Wide Input Voltage Range : 4.5V to 60V**
- **Low Quiescent Current : 30μA Operating and 2μA Shutdown**
- **Low Dropout Voltage : 400mV Maximum at 100mA**
- **Fixed (2.5V, 3.3V, 5V) and Adjustable (1.23V to 60V) Versions**
- **±3% Output Tolerance**
- **Stable with 1μF Output Capacitor (Aluminum, Tantalum or Ceramic)**
- **Inherent Reverse-Current Protection (No diode needed)**
- **-60V Reverse-Battery Protection**

Applications

- Low Current, High Voltage Regulators
- Battery Powered Applications
- Telecom and Datacom Applications
- Automotive Application

Typical Application Circuit

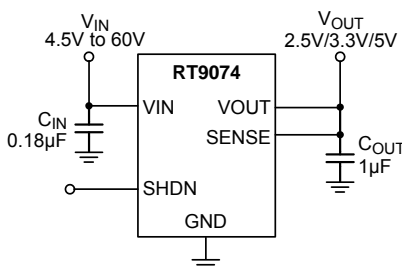

RT9074-25/33/50

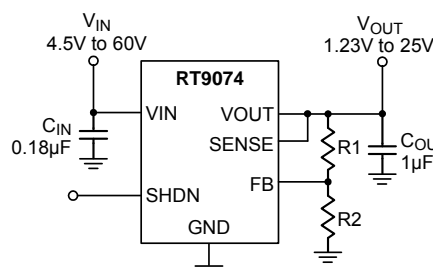

RT9074 (Adjustable Up to 25V Output)

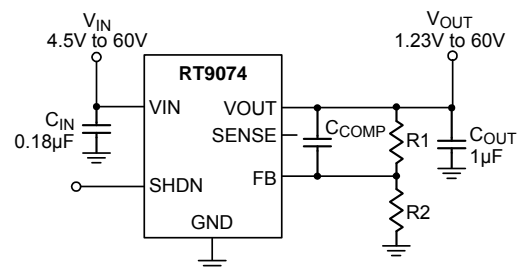

RT9074 (Adjustable Up to 60V Output)

Ordering and Marking Information

Part No.	Output Voltage	Package	Marking Information
RT9074-25GG	2.5V	SOT-223	RT907425GG
RT9074-25GSP		SOP-8 (Exposed Pad-Option 1)	RT907425GSP
RT9074-33GG	3.3V	SOT-223	RT907433GG
RT9074-33GSP		SOP-8 (Exposed Pad-Option 1)	RT907433GSP
RT9074-50GG	5V	SOT-223	RT907450GG
RT9074-50GSP		SOP-8 (Exposed Pad-Option 1)	RT907450GSP
RT9074 GSP	Adjustable	SOP-8 (Exposed Pad-Option 1)	RT9074GSP

Note :

Richtek products are :

- ▶ RoHS compliant and compatible with the current requirements of IPC/JEDEC J-STD-020.
- ▶ Suitable for use in SnPb or Pb-free soldering processes.

Pin Configuration

(TOP VIEW)

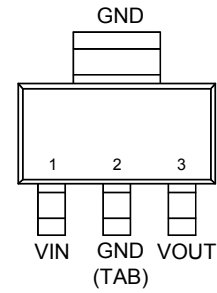

RT9074-25/33/50
SOT-223

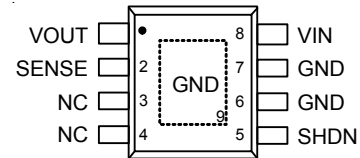

RT9074-25/33/50
SOP-8 (Exposed Pad)

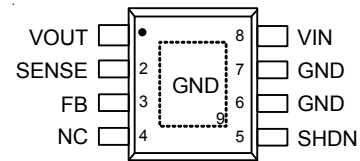

RT9074
SOP-8 (Exposed Pad)

Pin Description

Pin No.			Name	Function
RT9074-25/33/50GSP	RT9074GSP	RT9074GG		
1	1	3	VOUT	VOUT supplies power to the load. A minimum output capacitor of 1 μ F is required for stable operation.
2	2	--	SENSE	Output voltage sense. For applications with $V_{OUT} \leq 25V$, SENSE can be connected to the output voltage to optimize the control loop compensation. For applications with $V_{OUT} > 25V$ (adjustable versions only), SENSE must be left unconnected. Control loop compensation is optimized by adding a feed-forward capacitor in the feedback resistor divider connected to FB (see Adjustable Output Voltage and Compensation section).
3	--	--	NC	No internal connection.
--	3	--	FB	Feedback input. Connect to the center tap of a resistor divider for setting the output voltage. (Adjustable versions only)
4	--	--	NC	No internal connection.
5	5	--	SHDN	Shutdown control input (Active High). Connect SHDN high to disable the output voltage and reduce the IC's quiescent current to 2 μ A (typical). Connect SHDN low to enable the output. SHDN is a high-voltage input (also able to withstand reverse voltage) and can be connected directly to a high-voltage input.
6, 7, 9*	6, 7, 9*	2	GND	Ground. The exposed pad should be soldered to a large PCB and connected to GND for maximum thermal dissipation.
8	8	1	VIN	Power input. Bypass VIN with a 0.18 μ F or larger capacitor with adequate voltage rating.

* exposed pad

Functional Block Diagram

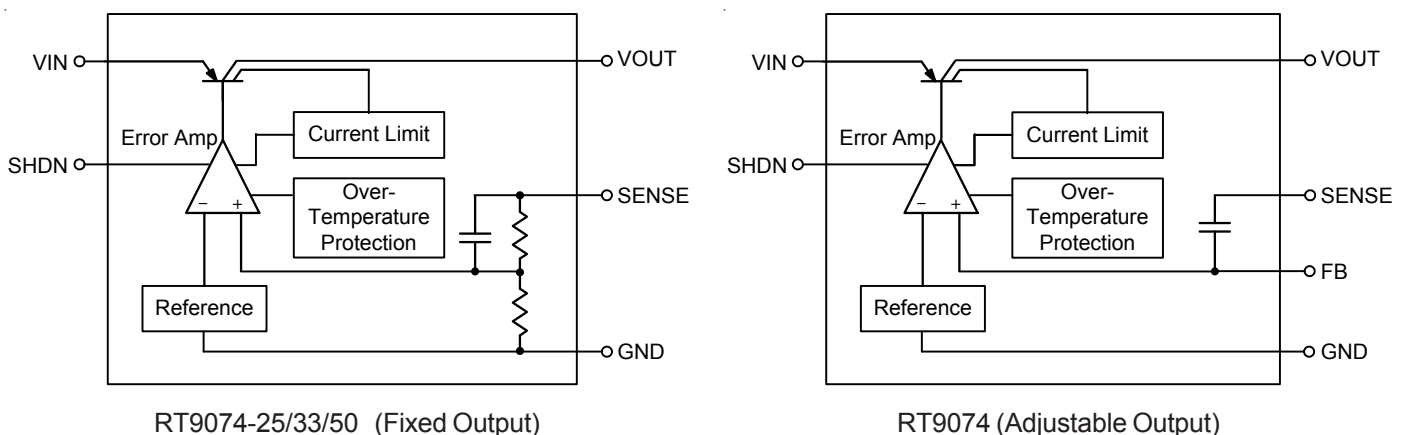

Operation

The RT9074 is a high input-voltage linear regulator specifically designed to minimize external components. The input voltage range is from 4.5V to 60V. The device supplies 100mA of output current with a maximum dropout voltage of 400mV. Its 30 μ A quiescent and 2 μ A shutdown currents make it ideal for use in battery-powered applications. Unlike many PNP LDO regulators, ground current does not increase much in dropout conditions.

Output Transistor

The RT9074 includes a built-in PNP output transistor configured for low dropout voltage. The output transistor blocks reverse current if the output voltage is held higher than the input voltage (such as in battery-backup applications) so no additional output blocking diode is needed.

Error Amplifier

The Error Amplifier compares the output feedback voltage from an internal feedback voltage divider (fixed output versions) or FB (adjustable output versions) to an internal reference voltage and controls the PNP output transistor's base current to maintain output voltage regulation. The RT9074's internal dividers are placed between SENSE and GND and have a divider resistance of about 1M Ω .

Current Limit Protection

The RT9074 provides a current limit function to prevent damage during output over-load or shorted-circuit conditions. The output current is detected by an internal current-sense transistor.

Over-Temperature Protection

The over temperature protection function will turn off the PNP output transistor when the internal junction temperature exceeds 155°C (typ.). Once the junction temperature cools down by approximately 5°C, the regulator will automatically resume operation.

Reverse-Battery Protection

The RT9074 inputs (VIN and SHDN) can withstand reverse voltages as high as -60V. Both the IC and the load are protected, as long as the load impedance is 500 Ω or less. In these conditions, the output voltage is guaranteed to be no more negative than -1V with the maximum negative input voltage. In battery-powered applications, no additional protection against battery reversal is typically needed.

Reverse-Output Protection

The RT9074 protects against current flow to the input (VIN) when the output voltage exceeds VIN. This simplifies battery and capacitive "keep-alive" circuits since they need no additional output blocking diode.

Shutdown Input (8 Pin Versions)

The RT9074 SHDN input is an active-high input that turns off the output transistor and reduces the quiescent current to 2 μ A typical. Connect SHDN to a voltage below 0.6V for normal operation.

Absolute Maximum Ratings (Note 1)

- VIN to GND ----- -60V to 80V
- SHDN to GND ----- -60V to 80V
- VOUT to GND ----- -40V to 80V
- SENSE to GND ----- -30V to 35V
- VIN to VOUT/SENSE when |VIN| ≥ |VOUT| (Normal Operation or Reverse-Battery Condition) ----- -60V to 80V
- VIN to VOUT/SENSE when VOUT ≥ VIN ≥ 0 (Reverse-VOUT Condition) ----- -35V
- FB ----- -0.3V to 10V
- FB Current ----- -6mA to 6mA
- Power Dissipation, PD @ TA = 25°C
 - SOT-223 ----- 1.25W
 - SOP-8 (Exposed Pad) ----- 3.26W
- Package Thermal Resistance (Note 2)
 - SOT-223, θJA ----- 80°C/W
 - SOP-8 (Exposed Pad), θJA ----- 30.6°C/W
 - SOT-223, θJC ----- 7.4°C/W
 - SOP-8 (Exposed Pad), θJC ----- 3.4°C/W
- Junction Temperature ----- 150°C
- Lead Temperature (Soldering, 10 sec.) ----- 260°C
- Storage Temperature Range ----- -65°C to 150°C
- ESD Susceptibility (Note 3)
 - HBM (Human Body Model) ----- 2kV

Recommended Operating Conditions (Note 4)

- Supply Input Voltage ----- 4.5V to 60V
- Junction Temperature Range ----- -40°C to 125°C
- Ambient Temperature Range ----- -40°C to 85°C

Electrical Characteristics

(4.5V < VIN < 60V, VSHDN = 0V, TA = 25°C, unless otherwise specified)

Parameter	Symbol	Test Conditions	Min	Typ	Max	Unit
Input Supply						
Operational VIN	VIN	0 < IOUT < 100mA	4.5	--	60	V
Quiescent Current	IQ	VIN = 24V, VSHDN = 0V	--	30	40	μA
Shutdown Current	ISHDN	VIN = 24V, VSHDN = 2.5V, VOUT = 0	--	2	15	μA
Input Reverse Leakage Current	IVINr	VIN = -60V, VOUT = 0V	--	--	0.1	mA
Output Voltage and Current						
Output Current Limit	ILIM		120	--	300	mA
Line Regulation	ΔVLINE	5.5V < VIN < 60V, IOUT = 100mA	--	1.2	--	%
Load Regulation	ΔVLOAD	0.1mA < IOUT < 100mA	--	1.2	--	%

Parameter		Symbol	Test Conditions	Min	Typ	Max	Unit
FB Voltage	RT9074	V _{FB}	0 < I _{OUT} < 100mA	1.205	1.23	1.255	V
Output Voltage	RT9074-25	V _{OUT}	0 < I _{OUT} < 100mA	2.425	2.5	2.575	V
	RT9074-33		0 < I _{OUT} < 100mA	3.2	3.3	3.4	
	RT9074-50		5.4V < V _{IN} < 60V, 0 < I _{OUT} < 100mA	4.85	5	5.15	
FB Input Bias Current	RT9074	I _{FB}		--	20	100	nA
Output Voltage with Reverse Polarity V _{IN}		V _{ROUT}	V _{IN} = -60V, R _L = 500Ω	--	--	-1	V
Dropout Voltage		V _{DROP}	I _{OUT} = 1mA	--	15	80	mV
			I _{OUT} = 10mA	--	55	150	
			I _{OUT} = 100mA	--	240	400	
Power Supply Rejection Rate		PSRR	f = 1kHz, I _{OUT} = 50mA	--	60	--	dB
Output Noise Voltage		V _{ON}	I _{OUT} = 50mA, f = 10Hz to 100kHz	--	200	--	μV _{RMS}
Shutdown							
Shutdown Output Voltage		V _{OUTSD}	SHDN = V _{IN}	--	--	100	mV
SHDN High Threshold		V _{IH}		--	1.6	2.2	V
SHDN Low Threshold		V _{IL}		0.6	1.2	--	V
SHDN Input Bias Current		I _{SHDN}	SHDN = V _{IN}	--	0.6	1.2	μA
			V _{SHDN} = 0V	--	--	0.1	
Thermal Protection							
Thermal Shutdown		T _{SD}		145	155	165	°C

Note 1. Stresses beyond those listed "Absolute Maximum Ratings" may cause permanent damage to the device. These are stress ratings only, and functional operation of the device at these or any other conditions beyond those indicated in the operational sections of the specifications is not implied. Exposure to absolute maximum rating conditions may affect device reliability.

Note 2. θ_{JA} is measured at T_A = 25°C on a high effective thermal conductivity four-layer test board per JEDEC 51-7. θ_{JC} is measured at the exposed pad of the package.

Note 3. Devices are ESD sensitive. Handling precaution is recommended.

Note 4. The device is not guaranteed to function outside its operating conditions.

Typical Operating Characteristics

($T_A = 25^\circ\text{C}$, $C_{IN} = 0.18\mu\text{F}$, $C_{OUT} = 1\mu\text{F}$, unless otherwise specified)

Output Voltage vs. Output Current

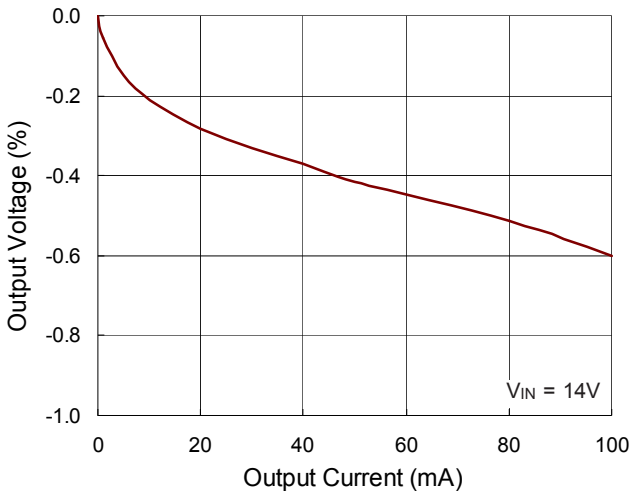

Quiescent Current vs. Input Voltage

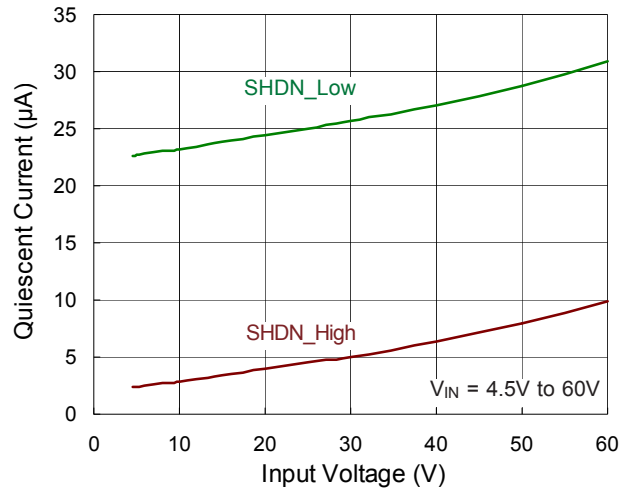

Output Voltage vs. Temperature

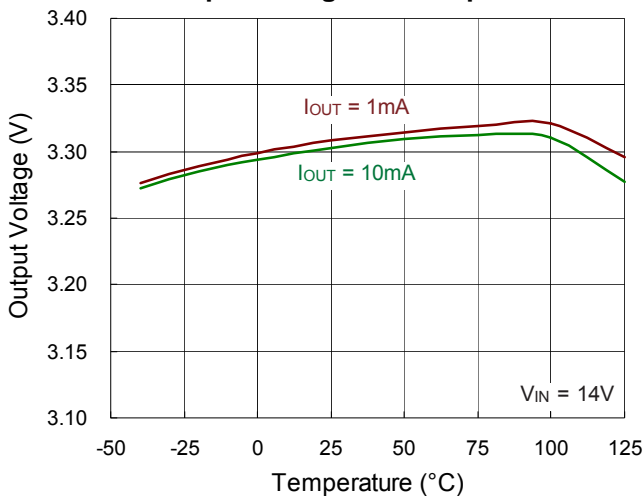

Quiescent Current vs. Temperature

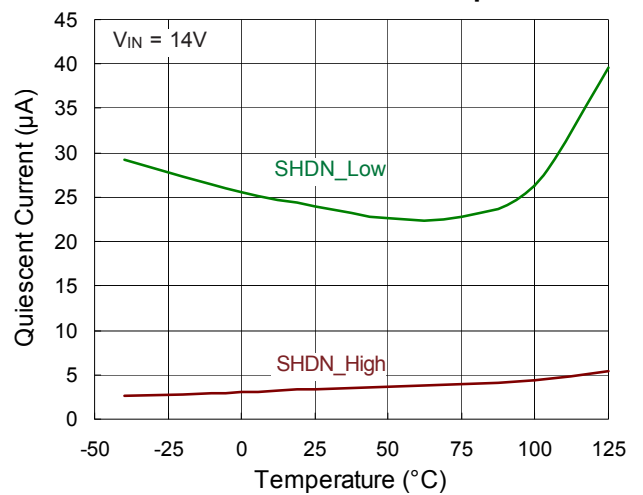

PSRR

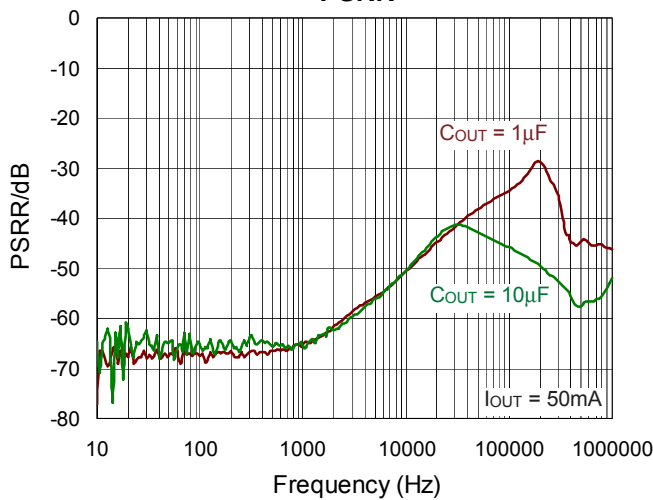

SHDN Threshold Voltage vs. Temperature

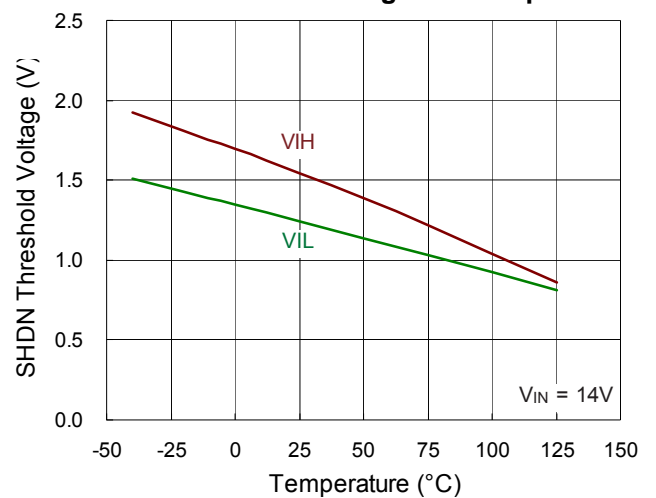

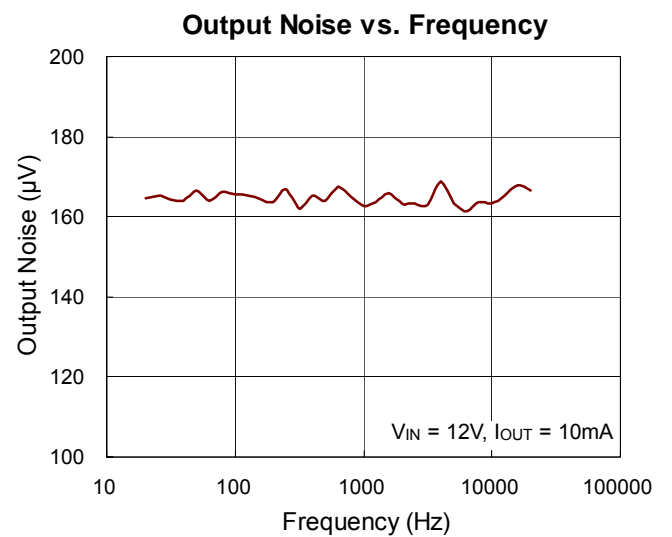
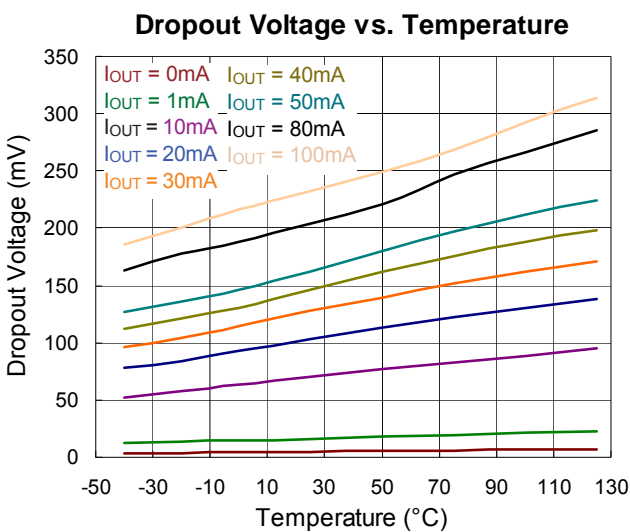
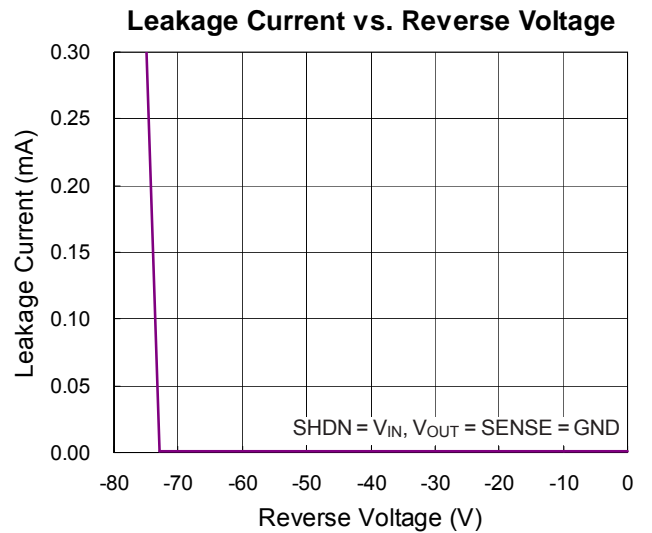
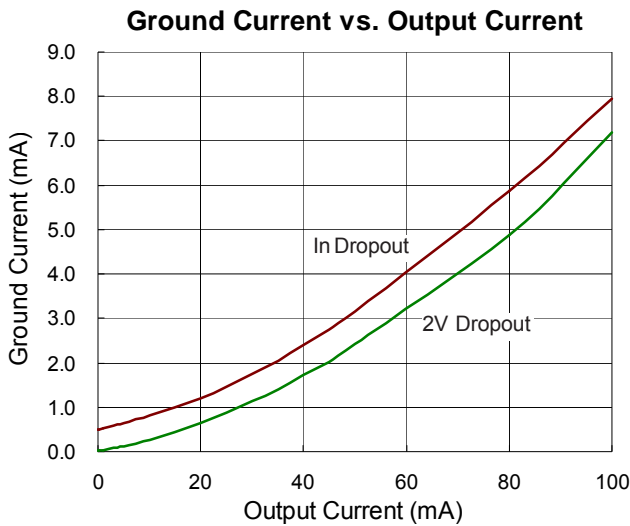
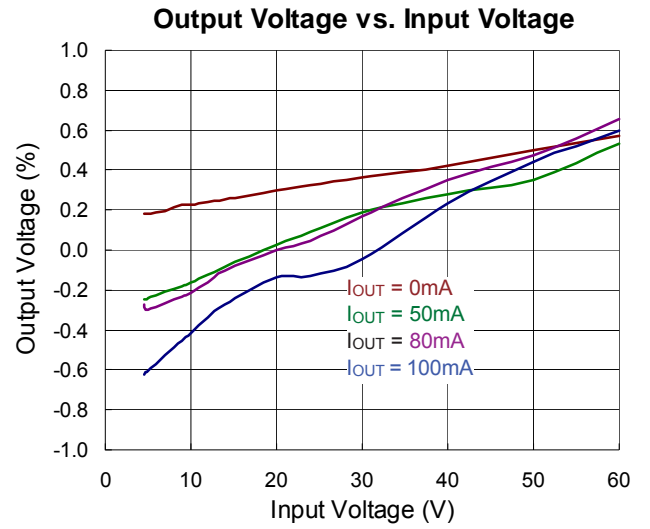
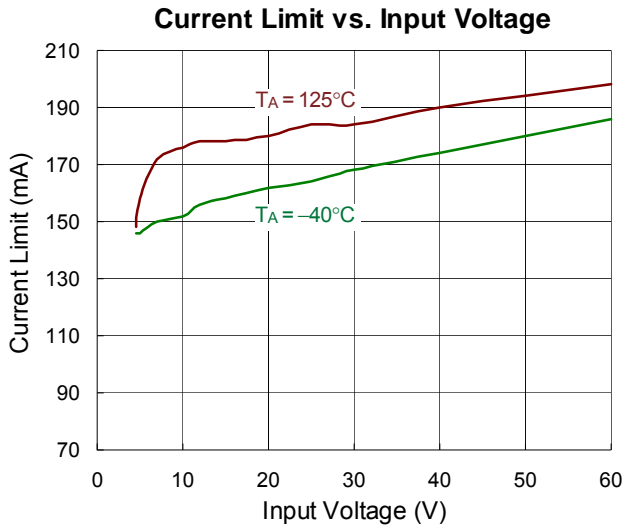

Minimum Input Voltage vs Temperature

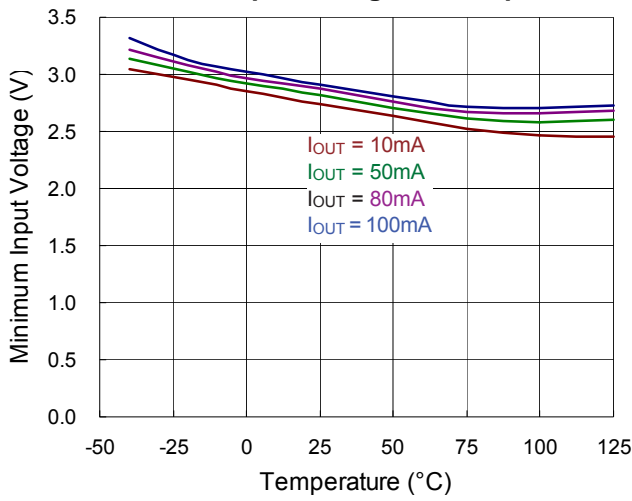

VOUT vs. VIN

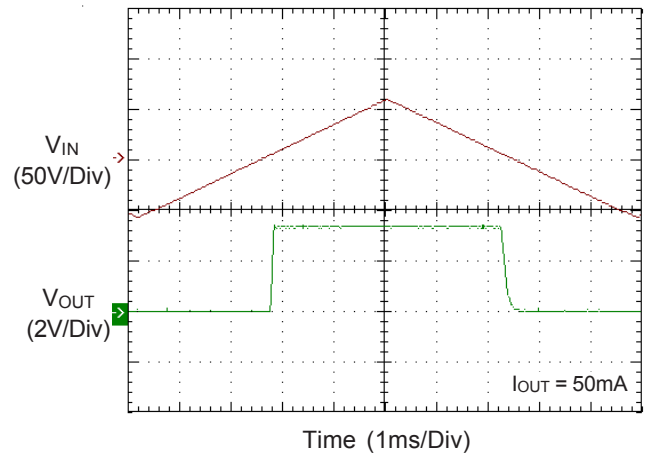

Load Transient Response

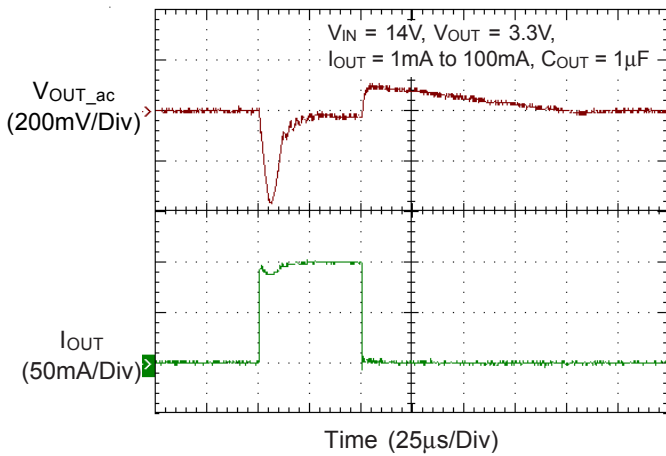

Line Transient Response

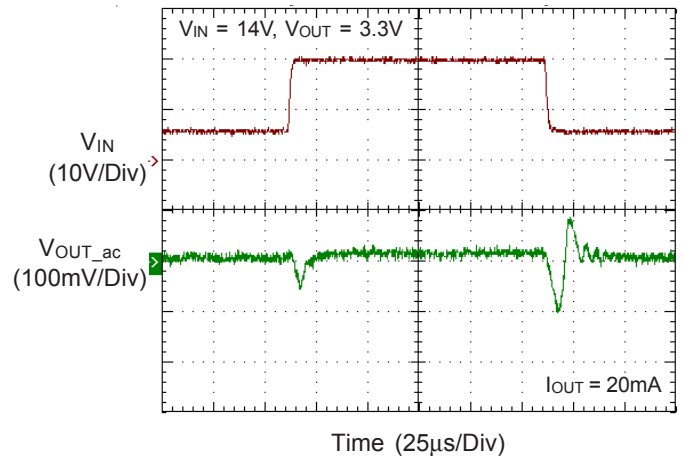

Load Transient Response

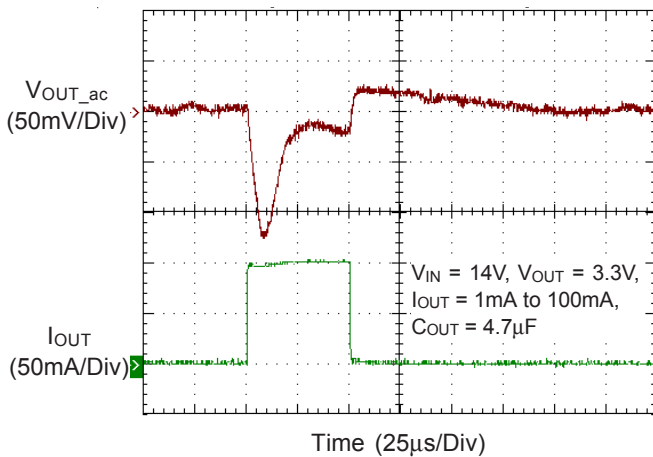

Load Transient Response

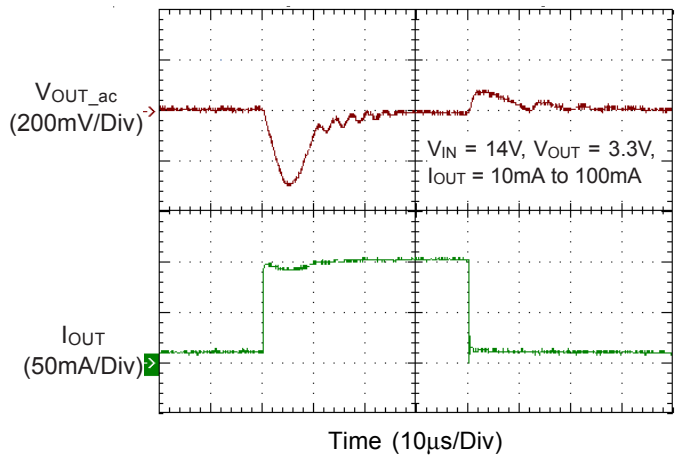

Load Transient Response

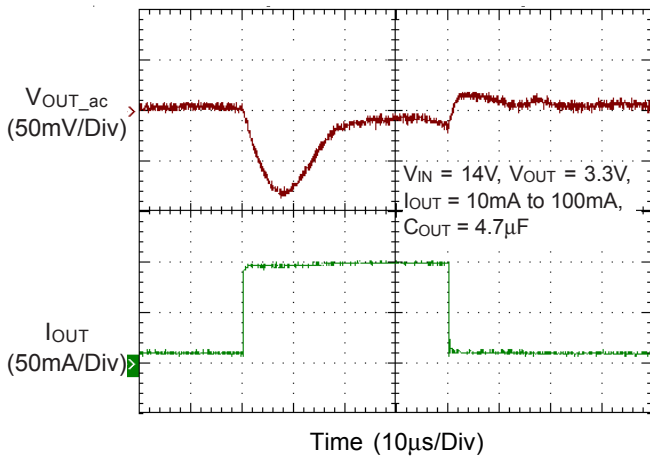

Power-On at No Load

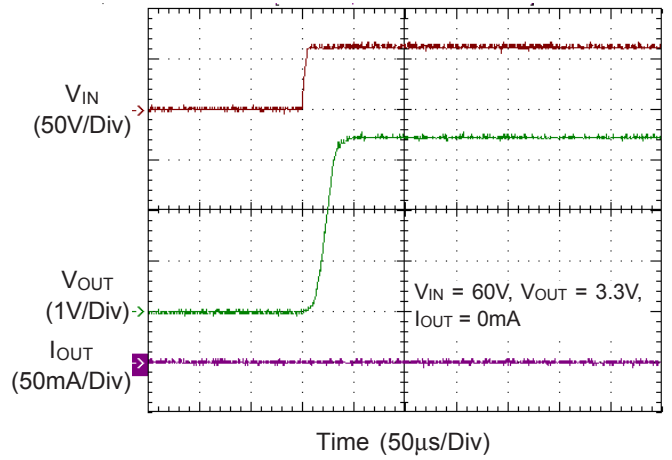

Turn-On by SHDN at No Load

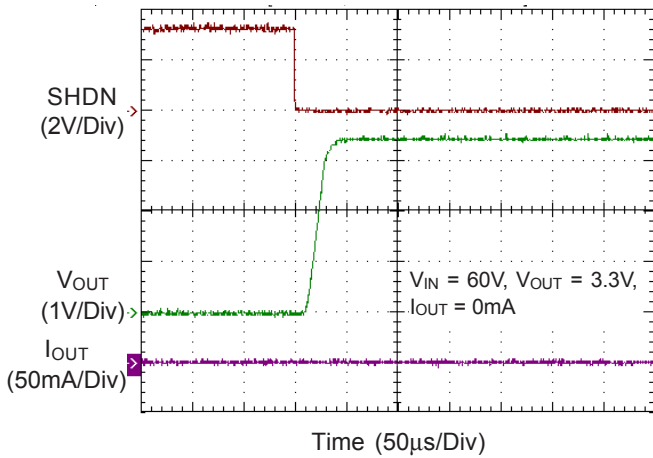

Power-On at 100mA Load

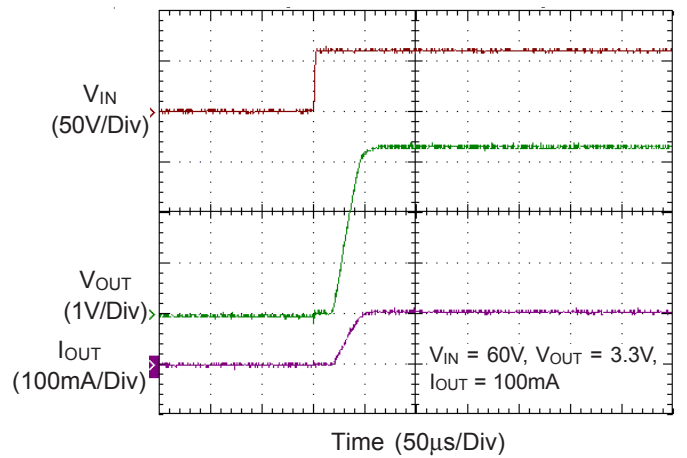

Turn-On by SHDN at 100mA Load

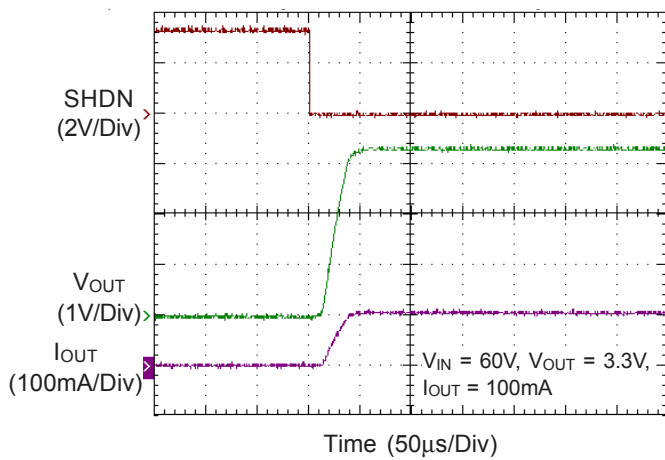

Applications Information

The RT9074 is a high input-voltage linear regulator specifically designed to minimize external components. The input voltage range is from 4.5V to 60V. The device supplies 100mA of output current with a maximum dropout voltage of 400mV.

Fixed V_{OUT} Applications

The fixed output versions are equipped with internal resistive dividers to set the output voltage to 2.5V, 3.3V, or 5V, respectively. The total resistance of the each internal feedback divider is about 1MΩ. The internal dividers connect between SENSE and GND, with the midpoint connecting to the input of the error amplifier. These versions are all internally compensated.

Adjustable Output Voltage and Compensation RT9074

The adjustable output versions may be set to provide from 1.23V to 60V, using external feedback voltage divider resistors (Figure 1). These included an internal feed-forward compensation capacitor, connected between SENSE and FB, which may be used when regulating at output voltages up to 25V. To achieve the correct compensation (together with your external FB divider, use an upper divider resistor (R1) value between 500kΩ and 1MΩ. Calculate R2 according to the following formula : $R2 = R1 / (V_{OUT} / 1.23V - 1)$.

For output voltages greater than 25V an external feed-forward capacitor (Figure 2) should be used and SENSE should be left unconnected. Choose a lower divider resistor (R2) at least 10kΩ and calculate R1 according to the following formula : $R1 = R2 \times (V_{OUT} / 1.23V - 1)$, Then, calculate the compensation capacitor (C_{COMP}) value according to the following formula : $C_{COMP} = 25\mu s / R1$.

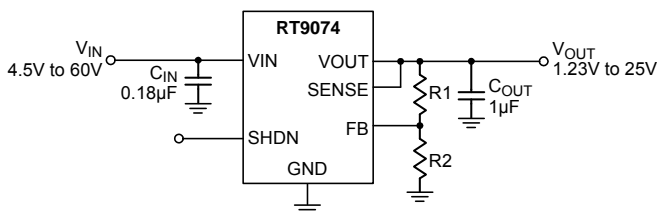

Figure 1. RT9074 Adjustable Output Up to 25V

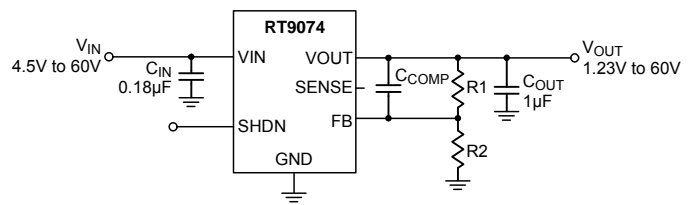

Figure 2. RT9074 Adjustable Output Above 25V

Remote-Sense Applications

Since V_{OUT} and SENSE (and FB) are separate pins, it is possible to connect SENSE to the output voltage remotely at the load (as long as the output voltage is 25V or less). FB can also be connected remotely, with SENSE unconnected if the output exceeds 25V. Remote sensing eliminates output voltage errors due to any resistive voltage drop between V_{OUT} and the load. (Voltage drops in the ground connection cannot be compensated.)

Added External NPN for High-Current Applications

Higher output currents and/or increased power dissipation are possible using an external NPN output transistor. V_{OUT} drives the base of the transistor and SENSE and/or FB monitors the actual output voltage, as in normal applications. The fixed-output versions (Figure 3) or adjustable-output version (Figure 4) can be used.

Figure 3 and Figure 4 have no current limit and should be used with care. If a crude current limit is desired, add the two diodes and resistor shown in Figure 5. The approximate current limit is 0.7V/R3. Any small switching diodes can be used and size R3 for the power dissipated in R3, which is typically 0.7V x 0.7V / R3.

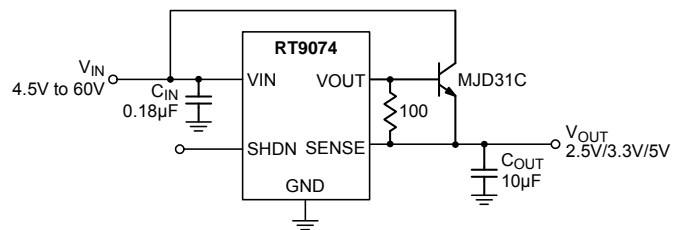

Figure 3. RT9074-25/33/50 External Transistor Application

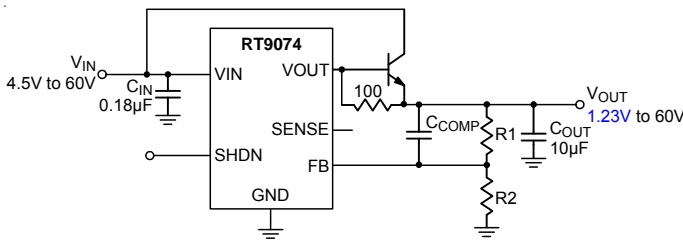

Figure 4. RT9074 External Transistor Application

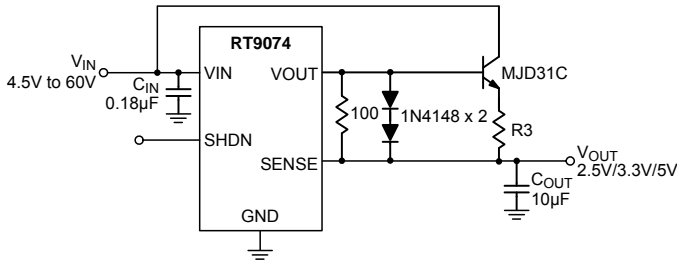

Figure 5. RT9074 External Transistor Application with Current Limit

Component Selection

A low-ESR capacitor such as ceramic type must be connected between VIN and GND with short, wide traces to bypass input noise. The RT9074 is designed to work with small input capacitor to reduce the cost from high-voltage low-ESR requirement. To guarantee a minimum 0.1µF input capacitance, a ceramic 0.18µF input capacitor with an appropriate voltage rating is recommended.

The RT9074 operates with any reasonable output capacitor including low-ESR ceramic types. Low-ESR aluminum and tantalum capacitor may also be used. A minimum of 1µF is recommended and much higher values are also acceptable. Connect the output capacitor between VOUT and GND with short, wide traces to keep the circuit stable.

Thermal Considerations

For continuous operation, do not exceed absolute maximum junction temperature. The maximum power dissipation depends on the thermal resistance of the IC package, PCB layout, rate of surrounding airflow, and difference between junction and ambient temperature. The maximum power dissipation can be calculated by the following formula :

$$P_{D(MAX)} = (T_{J(MAX)} - T_A) / \theta_{JA}$$

where $T_{J(MAX)}$ is the maximum junction temperature, T_A is the ambient temperature, and θ_{JA} is the junction to ambient thermal resistance.

For recommended operating condition specifications, the maximum junction temperature is 125°C. The junction to ambient thermal resistance, θ_{JA} , is layout dependent. For SOT-223 package, the thermal resistance, θ_{JA} , is 80°C/W on a standard JEDEC 51-7 four-layer thermal test board. For SOP-8 (Exposed Pad) package, the thermal resistance, θ_{JA} , is 30.6°C/W on a standard JEDEC 51-7 four-layer thermal test board. The maximum power dissipation at $T_A = 25^\circ\text{C}$ can be calculated by the following formulas :

$$P_{D(MAX)} = (125^\circ\text{C} - 25^\circ\text{C}) / (80^\circ\text{C/W}) = 1.25\text{W for SOT-223 package}$$

$$P_{D(MAX)} = (125^\circ\text{C} - 25^\circ\text{C}) / (30.6^\circ\text{C/W}) = 3.26\text{W for SOP-8 (Exposed Pad) package}$$

The maximum power dissipation depends on operating ambient temperature for fixed $T_{J(MAX)}$ and thermal resistance, θ_{JA} . The derating curves in Figure 6 allow the designer to see the effect of rising ambient temperature on the maximum power dissipation.

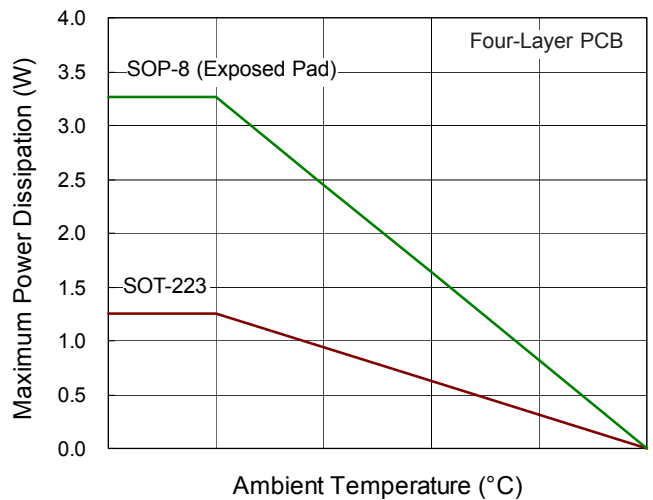

Figure 6. Derating Curve of Maximum Power Dissipation

Layout Consideration

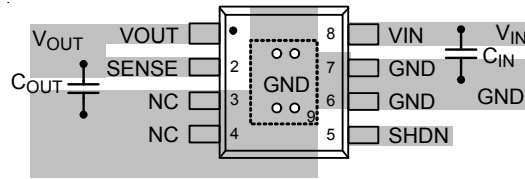
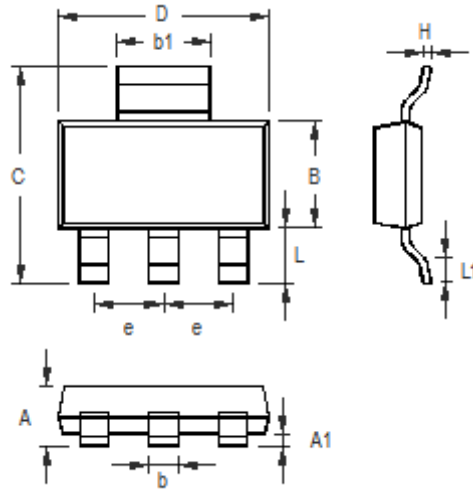

Figure 7. PCB Layout Guide

Outline Dimension



Symbol	Dimensions In Millimeters		Dimensions In Inches	
	Min	Max	Min	Max
A	1.400	1.800	0.055	0.071
A1	0.020	0.100	0.001	0.004
b	0.600	0.840	0.024	0.033
B	3.300	3.700	0.130	0.146
C	6.700	7.300	0.264	0.287
D	6.300	6.700	0.248	0.264
b1	2.900	3.100	0.114	0.122
e	2.300		0.091	
H	0.230	0.350	0.009	0.014
L	1.500	2.000	0.059	0.079
L1	0.800	1.100	0.031	0.043

3-Lead SOT-223 Surface Mount Package

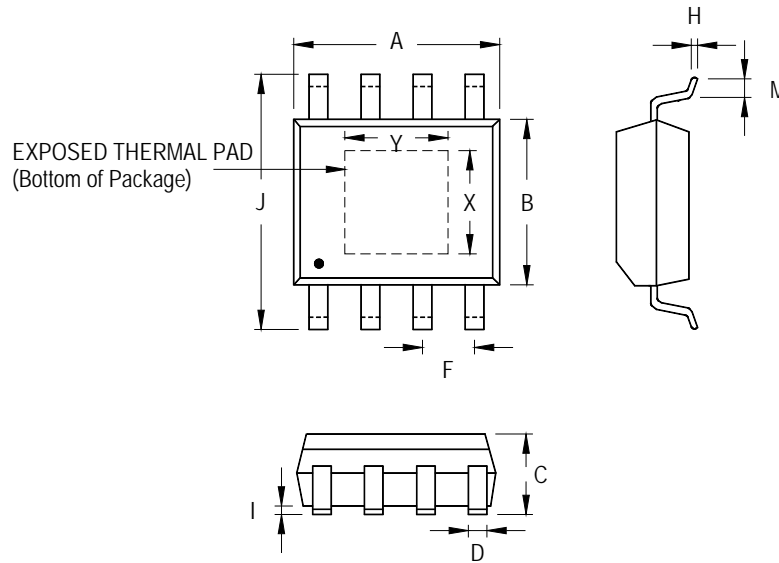

Symbol	Dimensions In Millimeters		Dimensions In Inches		
	Min	Max	Min	Max	
A	4.801	5.004	0.189	0.197	
B	3.810	4.000	0.150	0.157	
C	1.346	1.753	0.053	0.069	
D	0.330	0.510	0.013	0.020	
F	1.194	1.346	0.047	0.053	
H	0.170	0.254	0.007	0.010	
I	0.000	0.152	0.000	0.006	
J	5.791	6.200	0.228	0.244	
M	0.406	1.270	0.016	0.050	
Option 1	X	2.000	2.300	0.079	0.091
	Y	2.000	2.300	0.079	0.091
Option 2	X	2.100	2.500	0.083	0.098
	Y	3.000	3.500	0.118	0.138

8-Lead SOP (Exposed Pad) Plastic Package

Richtek Technology Corporation

14F, No. 8, Tai Yuen 1st Street, Chupei City
 Hsinchu, Taiwan, R.O.C.
 Tel: (8863)5526789

Richtek products are sold by description only. Customers should obtain the latest relevant information and data sheets before placing orders and should verify that such information is current and complete. Richtek cannot assume responsibility for use of any circuitry other than circuitry entirely embodied in a Richtek product. Information furnished by Richtek is believed to be accurate and reliable. However, no responsibility is assumed by Richtek or its subsidiaries for its use; nor for any infringements of patents or other rights of third parties which may result from its use. No license is granted by implication or otherwise under any patent or patent rights of Richtek or its subsidiaries.

单击下面可查看定价，库存，交付和生命周期等信息

[>>Richtek\(台湾立锜\)](#)