

High Efficiency Single Synchronous Buck PWM Controller

General Description

The RT8237E PWM controller provides high efficiency, excellent transient response, and high DC output accuracy needed for stepping down high voltage batteries to generate low voltage CPU core, I/O, and chipset RAM supplies in notebook computers.

The constant on-time PWM control scheme handles wide input/output voltage ratios with ease and provides 100ns “instant-on” response to load transients while maintaining a relatively constant switching frequency.

The RT8237E achieves high efficiency at a reduced cost by eliminating the current sense resistor found in traditional current mode PWMs. Efficiency is further enhanced by its ability to drive very large synchronous rectifier MOSFETs and enter diode emulation mode at light load condition. The Buck conversion allows this device to directly step down high voltage batteries at the highest possible efficiency. The pre-set frequency selections minimize design effort required for new designs. The RT8237E is intended for CPU core, chipset, DRAM, or other low voltage supplies as low as 0.7V. The RT8237E is available in the WDFN-10L 3x3 package.

Features

- Wide Input Voltage Range : 2.7V to 26V
- Output Voltage Range : 0.7V to 3.3V
- Built-In 0.5% 0.7V Reference Voltage
- Quick Load-Step Response within 100ns
- 4700ppm/°C Current Source for Current Limit $R_{DS(ON)}$
- Adjustable Current Limit with Low-Side MOSFET
- 4 Selectable Frequency Setting
- Soft-Start Control
- Drives Large Synchronous-Rectifier FETs
- Integrated Boot Switch
- Built-In OVP/OCP/UVP
- Thermal Shutdown
- Power Good Indicator
- RoHS Compliant and Halogen Free

Applications

- Notebook Computers
- CPU Core Supply
- Chipset/RAM Supply as Low as 0.7V
- Generic DC-DC Power Regulator

Simplified Application Circuit

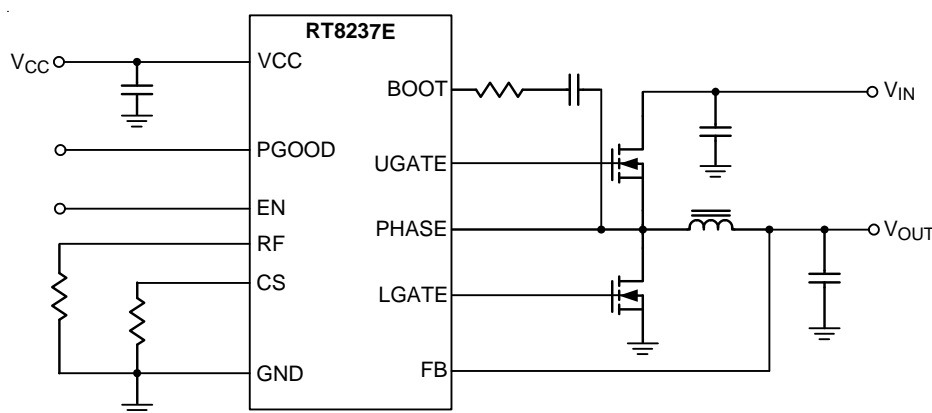

Ordering Information

RT8237E□□ (2)

- Pin 1 Orientation
(2) : Quadrant 2, Follow EIA-481-D
- Package Type
QW : WDFN-10L 3x3 (W-Type)
- Lead Plating System
Z : ECO (Ecological Element with Halogen Free and Pb free)

Pin Configuration

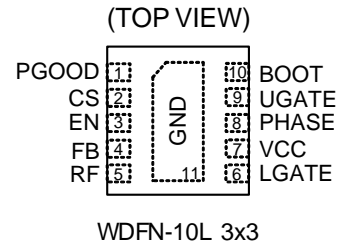

Note :

Richtek products are :

- ▶ RoHS compliant and compatible with the current requirements of IPC/JEDEC J-STD-020.
- ▶ Suitable for use in SnPb or Pb-free soldering processes.

Marking Information

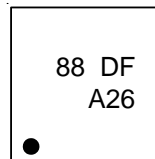

88 : Product Code
DFA26 : Date Code

Functional Pin Description

Pin No.	Pin Name	Pin Function
1	PGOOD	Open drain power good indicator. High impedance indicates power is good.
2	CS	Current limit threshold setting input. Connect a setting resistor to GND and the current limit threshold is equal to 1/8 of the voltage at this pin.
3	EN	Enable control input. Pull low to GND to disable the PWM.
4	FB	V _{OUT} feedback input. Connect FB to a resistor voltage divider from V _{OUT} to GND to adjust the output from 0.7V to 3.3V
5	RF	Switching frequency selection. Connect a resistance to select switching frequency as shown in Electrical Characteristics. The switching frequency is detected and latched after startup. This pin also controls diode emulation mode or forced CCM selection. Pull down to GND with resistor: Diode Emulation Mode. Connect to PGOOD with resistor: forced CCM after PGOOD becomes high.
6	LGATE	Gate drive output for low-side external MOSFET.
7	VCC	Supply voltage input. This pin provides the power for the buck controller, the low-side driver and the bootstrap circuit for high-side driver. Bypass to GND with a 1μF ceramic capacitor.
8	PHASE	External inductor connection pin for PWM converter. It behaves as the current sense comparator input for low-side MOSFET R _{DS(ON)} sensing and reference voltage for on time generation.
9	UGATE	Gate drive output for high-side external MOSFET.
10	BOOT	Bootstrap supply for high-side gate driver. Connect through a capacitor to the floating node (PHASE).
11 (Exposed Pad)	GND	Ground. The exposed pad must be soldered to a large PCB and connected to GND for maximum power dissipation.

Functional Block Diagram

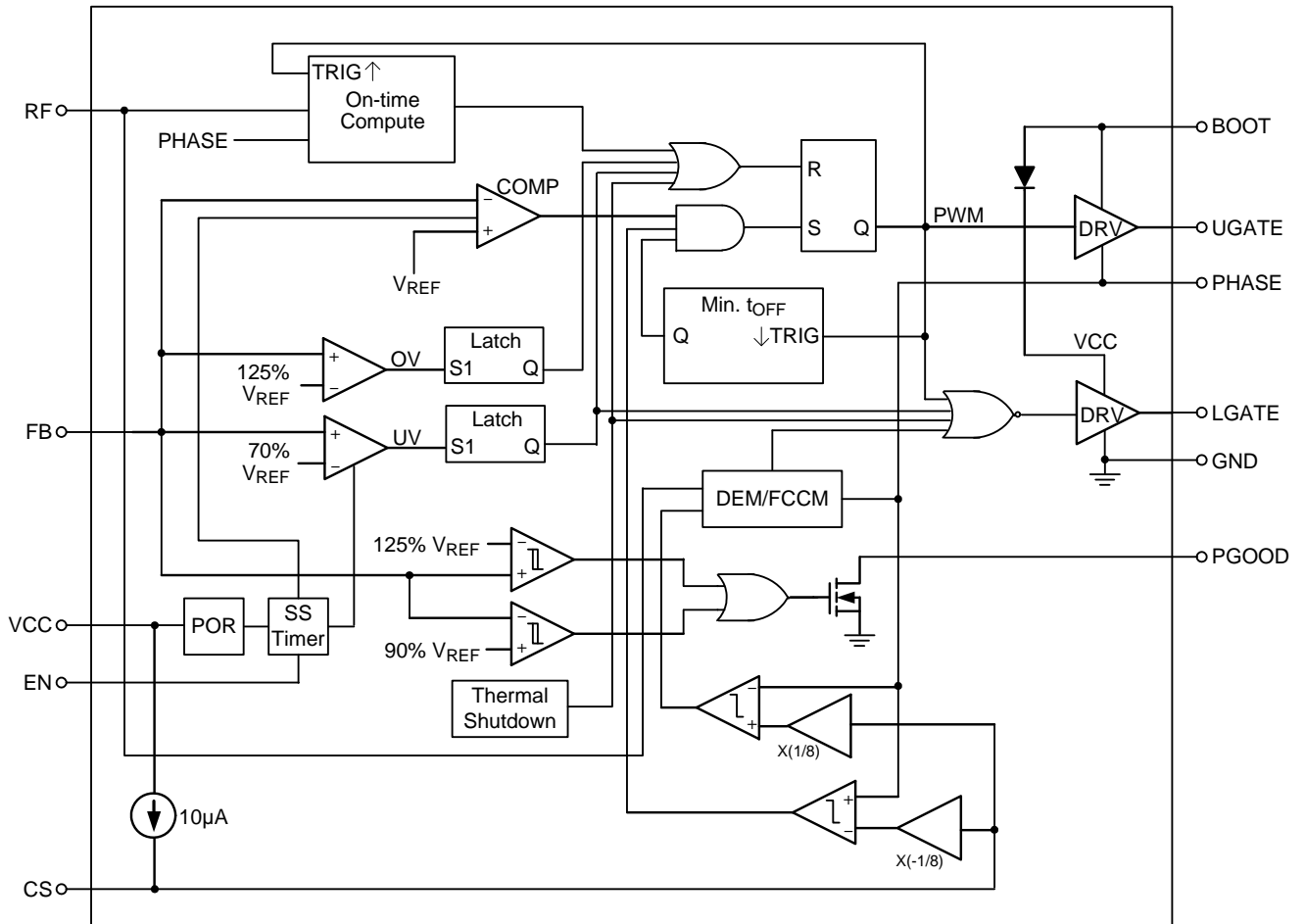

Operation

The RT8237E integrates a Constant-On-Time (COT) PWM controller, and the controller provides the PWM signal which relies on the output ripple voltage comparing with internal reference voltage.

The UGATE driver is turned on at the beginning of each cycle. After the internal one-shot timer expires, the UGATE driver will be turned off. The pulse width of this one-shot is determined by the converter's input voltage and the output voltage to keep the frequency fairly constant over the input voltage and output voltage range.

Power On Reset, UVLO

Power On Reset (POR) occurs when VCC rises above to approximately 4.1V (typical), the RT8237E will reset the fault latch and prepare the PWM for operation. When the input voltage below 3.7V(min), the Under Voltage Lockout (UVLO) circuitry inhibits switching by keeping UGATE and LGATE low.

Soft-Start

The output voltage will track the internal ramp voltage during soft-start interval to prevent large inrush current and output voltage overshoot while the converter is being powered up.

Mode Selection

The RT8237E supports mode selection through the RF by connecting a resistor from the RF pin to either GND or PGOOD. When the resistor is connected to GND, the controller operates in diode emulation mode. When the resistor is connected to PGOOD, the controller operates in CCM mode.

Current Limit Setting

The RT8237E has a cycle-by-cycle current limit control. The current limit circuit employs a unique "valley" current sensing algorithm. If the magnitude of the sensing signal at PHASE is above the current limit threshold, the PWM is not allowed to initiate a new cycle.

Over Voltage Protection

The output voltage can be continuously monitored for over voltage condition. When the output voltage exceeds 25% of its set voltage threshold, the UGATE goes low and the LGATE is forced high.

Under Voltage Protection

The output voltage can be continuously monitored for under voltage condition. When the output voltage is less than 70% of its set voltage, under voltage protection is triggered and then both UGATE and LGATE gate drivers are forced low.

Absolute Maximum Ratings (Note 1)

• VCC, FB, PGOOD, EN, CS, RF to GND	-----	-0.3V to 6.5V
• BOOT to GND		
DC	-----	-0.3V to 36V
<100ns	-----	-5V to 42V
• BOOT to PHASE		
DC	-----	-0.3V to 6V
<100ns	-----	-5V to 7.5V
• PHASE to GND		
DC	-----	-5V to 30V
<100ns	-----	-10V to 42V
• UGATE to GND		
DC	-----	-5V to 36V
<100ns	-----	-10V to 42V
• UGATE to PHASE	-----	-0.3V to 6V
DC	-----	-0.3V to 6V
<100ns	-----	-5V to 7.5V
• LGATE to GND	-----	-0.3V to 6V
DC	-----	-0.3V to 6V
<100ns	-----	-5V to 7.5V
• Power Dissipation, P _D @ T _A = 25°C		
WDFN-10L 3x3	-----	3.28W
• Package Thermal Resistance (Note 2)		
WDFN-10L 3x3, θ _{JA}	-----	30.5°C/W
WDFN-10L 3x3, θ _{JC}	-----	7.5°C/W
• Lead Temperature (Soldering, 10 sec.)	-----	260°C
• Junction Temperature	-----	150°C
• Storage Temperature Range	-----	-65°C to 150°C
• ESD Susceptibility (Note 3)		
HBM (Human Body Model)	-----	2kV

Recommended Operating Conditions (Note 4)

• Input Voltage, V _{IN}	-----	2.7V to 26V
• Control Voltage, V _C	-----	4.5V to 5.5V
• Junction Temperature Range	-----	-40°C to 125°C
• Ambient Temperature Range	-----	-40°C to 85°C

Electrical Characteristics

(V_{CC} = 5V, T_A = 25°C, unless otherwise specified)

Parameter	Symbol	Test Conditions	Min	Typ	Max	Unit
Input Power Supply						
V _{CC} Quiescent Supply Current	I _Q	FB forced above the regulation point, V _{EN} = 5V	--	0.5	1.25	mA
V _{CC} Shutdown Current	I _{SHDN}	V _{CC} current, V _{EN} = 0V	--	--	1	μA
CS Shutdown Current		CS pull to GND	--	--	1	μA
FB Error Comparator Threshold	V _{REF}	DEM	0.7005	0.704	0.7075	V
		DEM, T _A = -40 to 85°C (Note 5)	0.697	0.704	0.711	
FB INPUT BIAS CURRENT		V _{FB} = 0.735V	-1	0.01	1	μA
V _{OUT} Voltage Range			0.7	--	3.3	V
Switching Frequency	f _{sw}	R _{RF} = 470kΩ (Note 6)	--	290	--	kHz
		R _{RF} = 200kΩ (Note 6)	--	340	--	
		R _{RF} = 100kΩ (Note 6)	--	380	--	
		R _{RF} = 39kΩ (Note 6)	--	430	--	
Minimum Off-Time			250	400	550	ns
Current Sensing						
CS Source Current	I _{CS}		9	10	11	μA
CS Source Current TC			--	4700	--	ppm/°C
Zero Crossing Threshold		DEM	-10	--	5	mV
Current Limit Threshold	V _{LIM}	GND – PHASE, V _{CS} = 2.4V	280	300	320	mV
		GND – PHASE, V _{CS} = 1.6V	185	200	215	
		GND – PHASE, V _{CS} = 0.4V	40	50	60	
Negative Current Limit Threshold		PHASE – GND, V _{CS} = 2.4V	--	300	--	mV
		PHASE – GND, V _{CS} = 1.6V	--	200	--	
		PHASE – GND, V _{CS} = 0.4V	--	50	--	
Protection Function						
Output UV Threshold		With respect to error comparator threshold	65	70	75	%
OVP Threshold		With respect to error comparator threshold	120	125	130	%
OV Fault Delay		FB forced above OV threshold	--	5	--	μs
V _{CC} Under Voltage Lockout Threshold	UVLO	Falling edge, hysteresis = 100mV, PWM disabled below this level	3.7	3.9	4.1	V
V _{OUT} Soft-Start		From EN = high to V _{OUT} = 95%	--	1300	--	μs
UV Blank Time		From EN signal going high	--	3	--	ms
Thermal Shutdown	T _{SD}		--	150	--	°C

Parameter	Symbol	Test Conditions	Min	Typ	Max	Unit
Driver On Resistance						
UGATE Drive Source	RUGATE _{sr}	BOOT – PHASE forced to 5V	--	1.8	3.6	Ω
UGATE Drive Sink	RUGATE _{sk}	BOOT – PHASE forced to 5V	--	1.2	2.4	Ω
LGATE Drive Source	RLGATE _{sr}	LGATE, High State	--	1.8	3.6	Ω
LGATE Drive Sink	RLGATE _{sk}	LGATE, Low State	--	0.8	1.6	Ω
Dead Time		LGATE Rising (V _{PHASE} = 1.5V)	--	30	--	ns
		UGATE Rising	--	30	--	
Internal Boost Charging Switch On Resistance		VCC to BOOT, 10mA	--	--	80	Ω
EN Threshold						
EN Input Voltage	Logic-High	V _{IH}	1.8	--	--	V
	Logic-Low	V _{IL}	--	--	0.5	
Mode Decision						
V _{RF} Threshold for DEM			--	--	0.5	V
V _{RF} Threshold for FCCM			1.8	--	--	V
PGOOD						
Trip Threshold (falling, leaving PGOOD)		Measured at FB, with respect to reference, Hysteresis = 3%	87	90	93	%
Trip Threshold (rising, leaving PGOOD)		Measured at FB, with respect to reference, Hysteresis = 3%	120	125	130	%
Fault Propagation Delay		Falling Edge, FB forced below PGOOD trip threshold	--	2.5	--	μs
Output Low Voltage		I _{SINK} = 1mA	--	--	0.4	V
Leakage Current		High State, forced to 5V	--	--	1	μA

Note 1. Stresses beyond those listed “Absolute Maximum Ratings” may cause permanent damage to the device. These are stress ratings only, and functional operation of the device at these or any other conditions beyond those indicated in the operational sections of the specifications is not implied. Exposure to absolute maximum rating conditions may affect device reliability.

Note 2. θ_{JA} is measured under natural convection (still air) at T_A = 25°C with the component mounted on a high effective-thermal-conductivity four-layer test board on a JEDEC 51-7 thermal measurement standard. θ_{JC} is measured at the exposed pad of the package.

Note 3. Devices are ESD sensitive. Handling precaution is recommended.

Note 4. The device is not guaranteed to function outside its operating conditions.

Note 5. Guaranteed by design. Not production tested.

Note 6. Not production tested. Test condition is V_{IN} = 8V, V_{OUT} = 1.1V, I_{OUT} = 10A using application circuit.

Typical Application Circuit

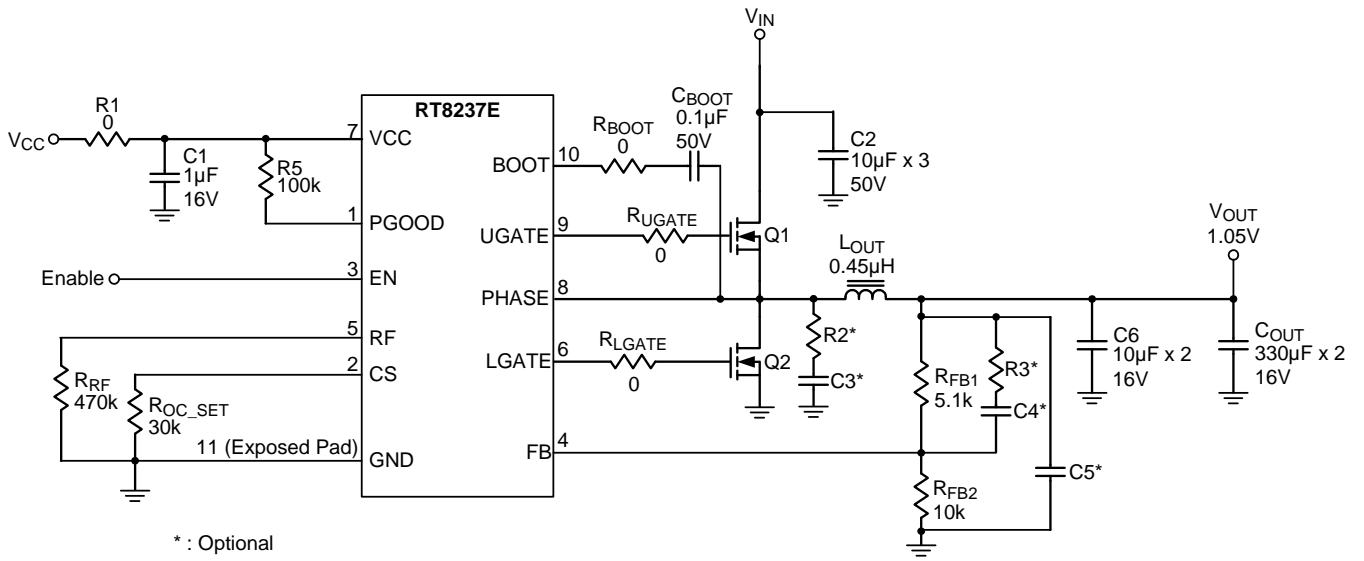

Typical Operating Characteristics

Efficiency vs. Load Current

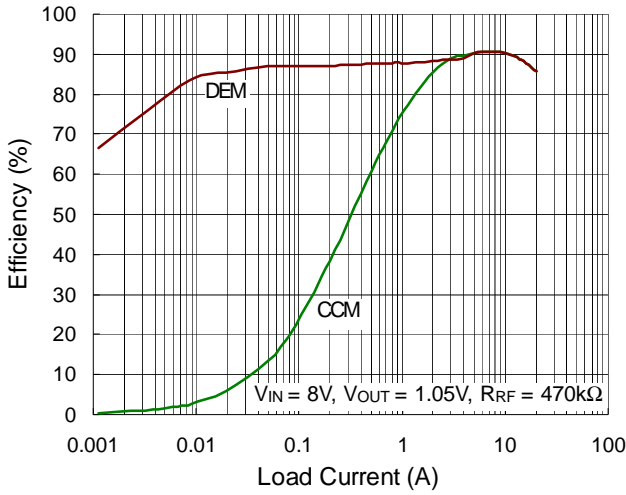

Efficiency vs. Load Current

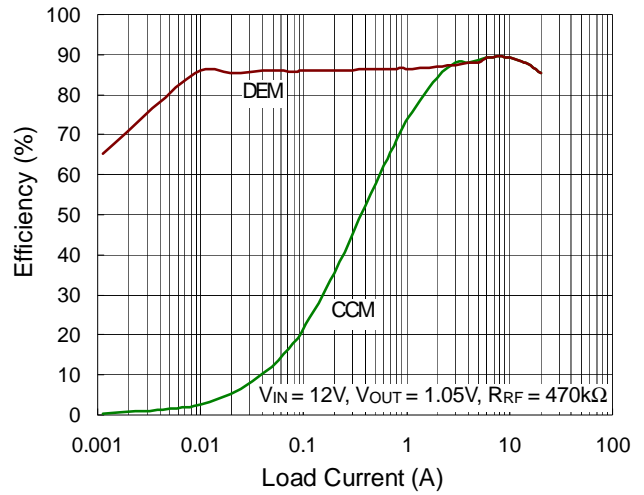

Efficiency vs. Load Current

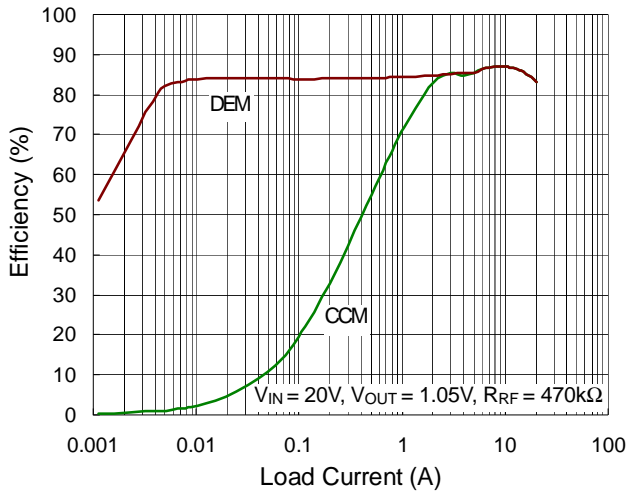

Switching Frequency vs. Load Current

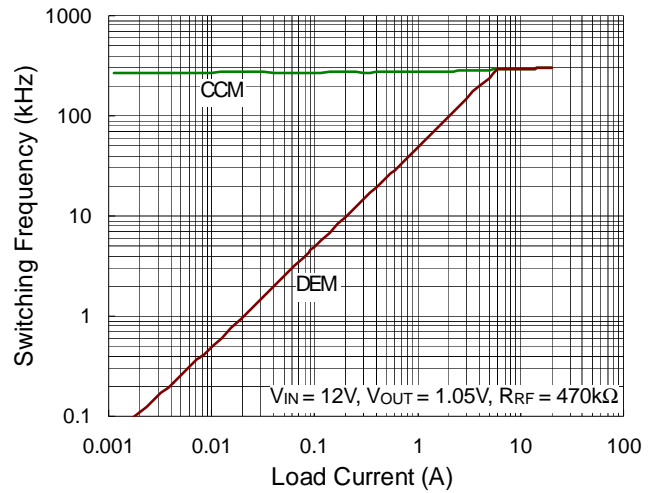

Switching Frequency vs. Load Current

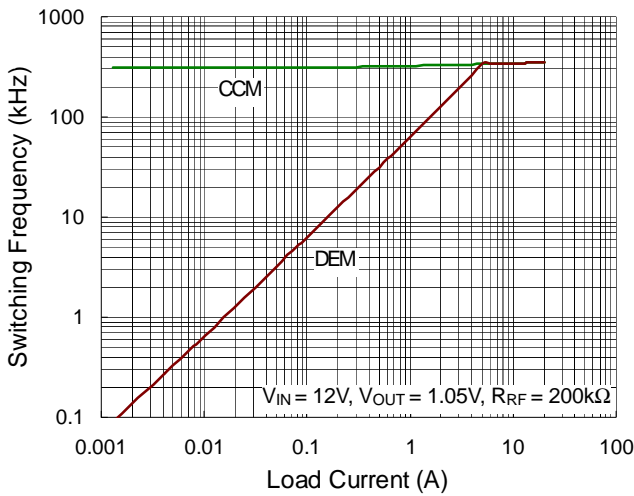

Switching Frequency vs. Load Current

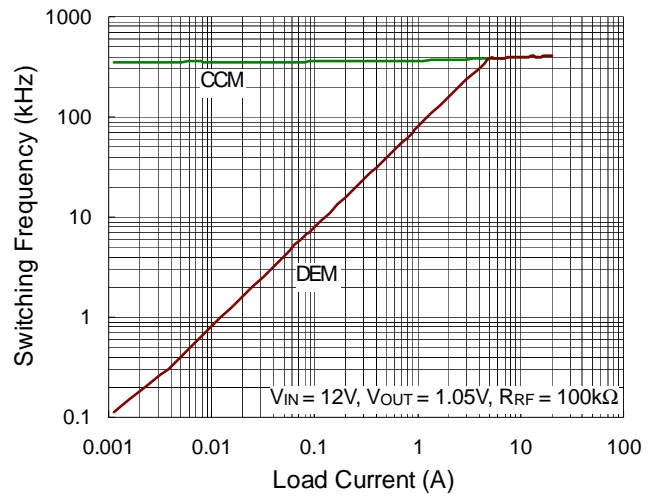

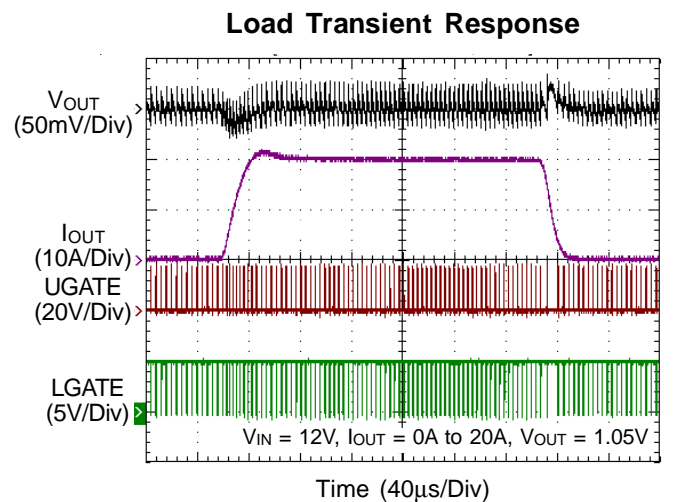
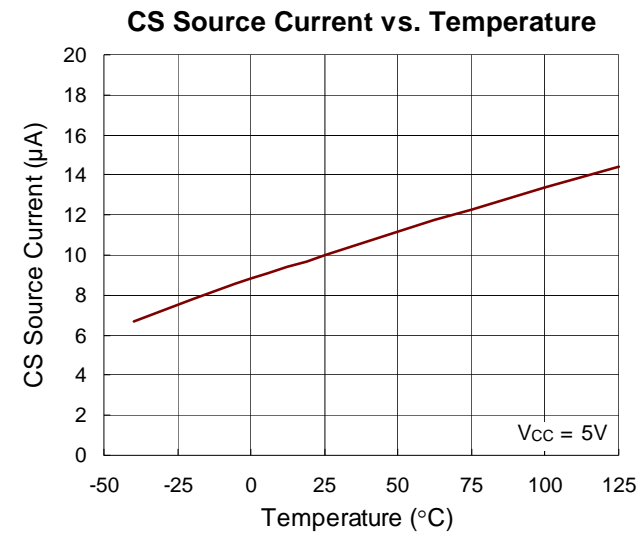
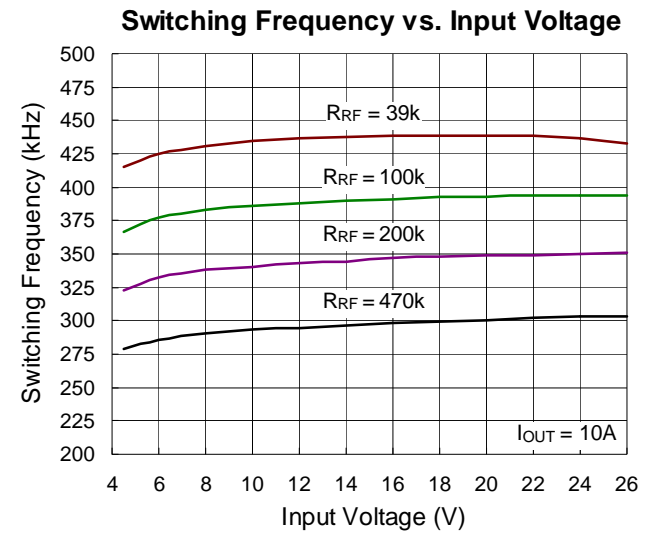
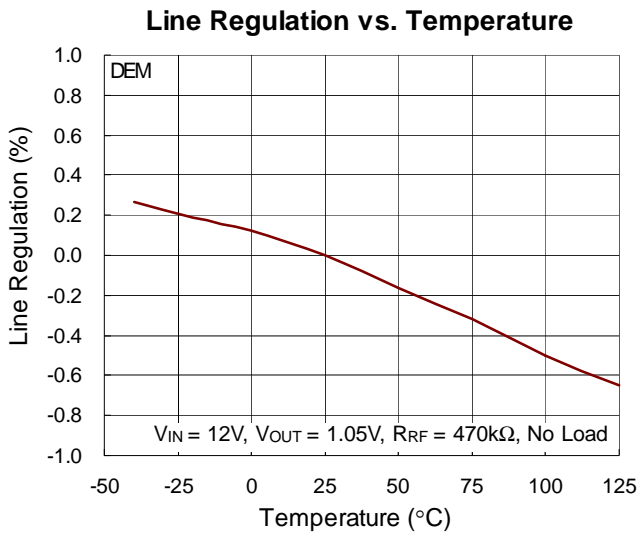
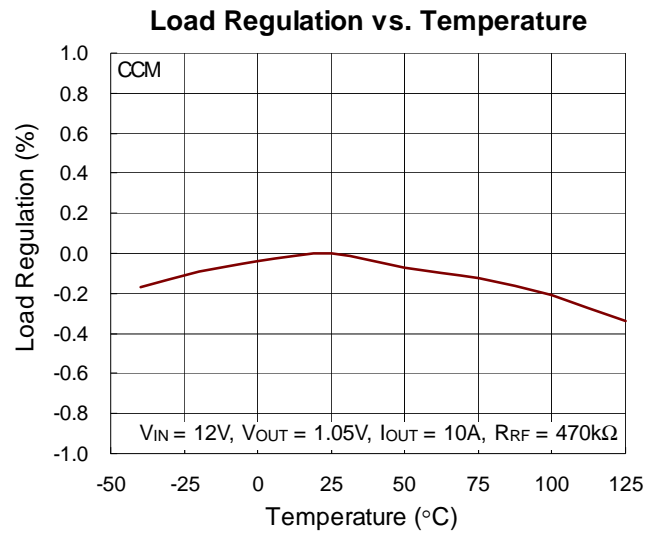
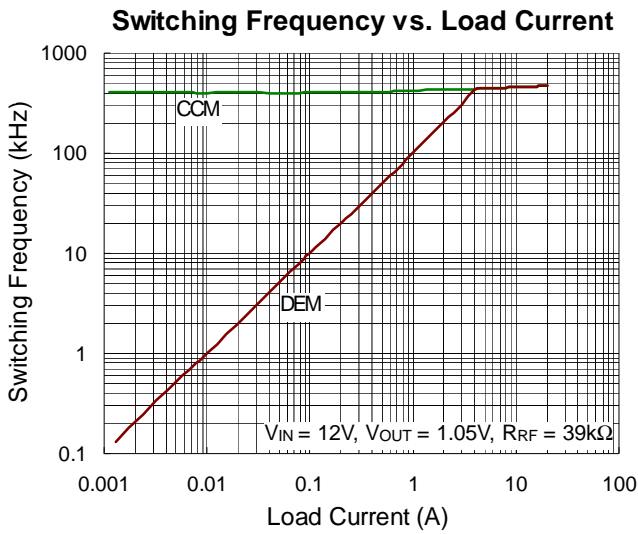

OVP

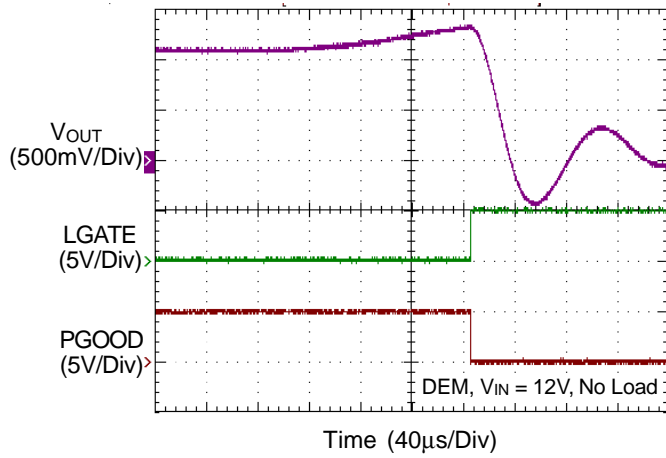

UVP

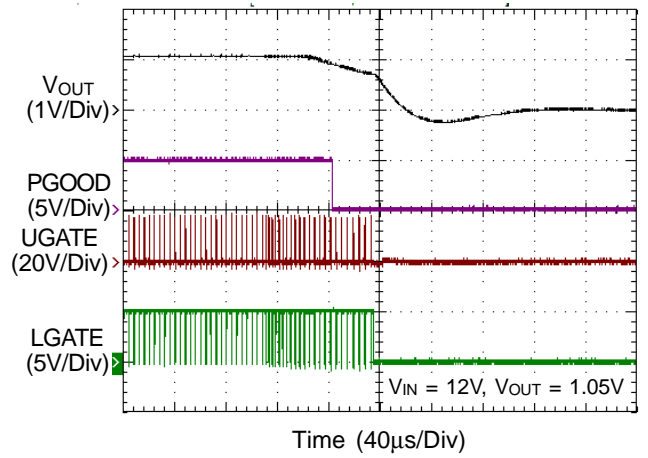

Power On from EN

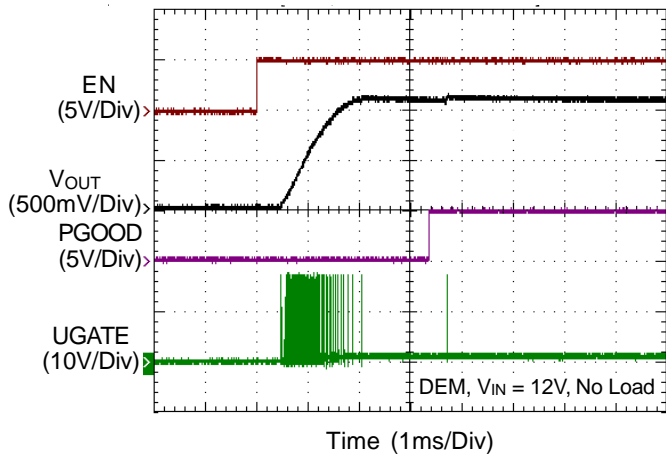

Power On from EN

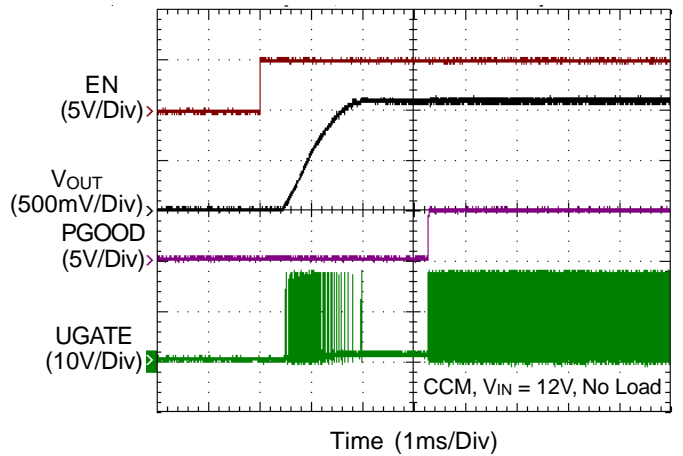

Application Information

The RT8237E PWM controller provides high efficiency, excellent transient response, and high DC output accuracy needed for stepping down high voltage batteries to generate low voltage CPU core, I/O, and chipset RAM supplies in notebook computers. Richtek Mach Response™ technology is specifically designed for providing 100ns “instant-on” response to load steps while maintaining a relatively constant operating frequency and inductor operating point over a wide range of input voltages. The topology solves the poor load transient response timing problems of fixed frequency current mode PWMs and avoids the problems caused by widely varying switching frequencies in conventional constant on-time and constant off-time PWM schemes.

On-Time Control (TON/MODE)

The on-time one-shot comparator has two inputs. One input monitors the output voltage from the PHASE pin, while the other input samples the input voltage and converts it to a current. This input voltage proportional current is used to charge an internal on-time capacitor. The on-time is the time required for the voltage on this capacitor to charge from zero volts to V_{OUT}, thereby making the on-time of the high-side switch directly proportional to output voltage and inversely proportional to input voltage.

The on-time is given by :

$$t_{ON} = (V_{OUT} / (V_{IN} - 0.7V)) / f_{SW}$$

Table 1. RF Connection and Switching Frequency

R _{RF} (kΩ)	Switching Frequency (kHz)
470kΩ	290
200kΩ	340
100kΩ	380
39kΩ	430

Note : For DEM, connect R_{RF} to GND; for CCM, connect R_{RF} to PGOOD.

Enable and Disable

The EN pin allows for power sequencing between the controller bias voltage and another voltage rail. The RT8237E remains in shutdown if the EN pin is lower than 500mV. When the EN pin rises above the V_{EN} trip point, the RT8237E will begin a new initialization and soft-start cycle.

POR, UVLO and Soft-Start

Power-on reset (POR) occurs when V_{CC} rises above approximately 4.1V, in which the RT8237E resets the fault latch and prepares the PWM for operation. When the input voltage below 3.7V (min), the V_{CC} Under Voltage Lockout (UVLO) circuitry inhibits switching by keeping UGATE and LGATE low. A built-in soft-start is used to prevent the power supply input from surge currents after PWM is enabled. A ramping up current limit threshold eliminates the V_{OUT} folded-back current during the soft-start duration.

Mode Selection (RF) Operation

To select the operation mode, connect a resistor from the RF pin to either GND or PGOOD. When the resistor is connected to GND, the controller operates in diode emulation mode. When the resistor is connected to PGOOD, the controller operates in CCM mode.

Diode-Emulation Mode (R_{RF} connected to GND)

In diode-emulation mode, the RT8237E automatically reduces switching frequency at light load conditions to maintain high efficiency. This reduction of frequency is achieved smoothly without increasing V_{OUT} ripple or load regulation. As the output current decreases from heavy load condition, the inductor current is reduced and eventually comes to the point where its valley touches zero current, which is the boundary between continuous conduction and discontinuous conduction modes. To emulate the behavior of diodes, the low-side MOSFET allows only partial negative current to flow when the inductor freewheeling current reaches negative. As the load current is further decreased, it takes longer and longer to discharge the output capacitor to the level that requires

the next "ON" cycle. The on-time is kept the same as that in heavy load condition. On the contrary, when the output current increases from light load to heavy load, the switching frequency increases to the preset value as the inductor current reaches the continuous condition. This is shown in Figure 1. The transition load point to the light load operation is calculated as follows :

$$I_{LOAD} \approx \frac{(V_{IN} - V_{OUT})}{2L} \times t_{ON}$$

where t_{ON} is the on-time.

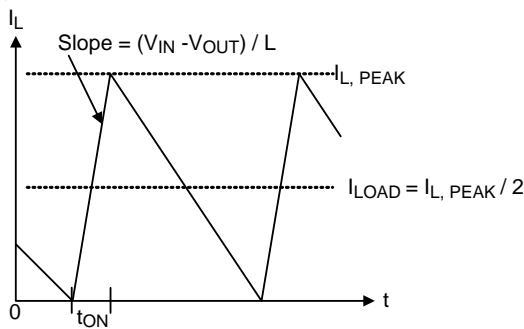

Figure 1. Boundary Condition of CCM/DCM

The switching waveforms may appear noisy and asynchronous when light loading causes diode-emulation operation, but this is a normal operating condition that results in high light load efficiency. Trade-offs in DEM noise vs. light load efficiency is made by varying the inductor value. Generally, low inductor values produce a broader efficiency vs. load curve, while higher values result in higher full load efficiency (assuming that the coil resistance remains fixed) and less output voltage ripple. The disadvantages for using higher inductor values include larger physical size and degraded load transient response (especially at low input voltage levels).

Forced-CCM Mode (FCCM)

The low noise, forced-CCM mode disables the zero-crossing comparator, which controls the low-side switch on-time. This causes the low-side gate drive waveform to become the complement of the high-side gate drive waveform. This in turn causes the inductor current to reverse at light loads as the PWM loop to maintain duty ratio V_{OUT}/V_{IN} . A fairly constant switching frequency is

the benefit of forced-CCM mode, but this comes at a cost. The no load battery current can be up to 10mA to 40mA, depending on the external MOSFETs.

Current Limit Setting (CS)

The RT8237E has a cycle-by-cycle current limit control. The current limit circuit employs a unique "valley" current sensing algorithm. If the magnitude of the current sense signal at PHASE is above the current limit threshold, the PWM is not allowed to initiate a new cycle (see Figure 2). In order to provide both good accuracy and a cost effective solution, the RT8237E supports temperature compensated MOSFET $R_{DS(ON)}$ sensing.

The CS pin of the RT8237E is a multiplexed pin for PWM enable/disable control and current limit threshold setting. Connect a setting resistor from this pin to GND via an N-MOSFET. When the N-MOSFET is turned off, the PWM is disabled. When the N-MOSFET is turned on, the PWM is enabled and the current limit threshold is equal to 1/8 of the voltage at this pin.

Choose a current limit resistor by following below equation:

$$R_{OC_SET} = \frac{V_{CS_OC}}{I_{CS}} = \frac{\left(I_{LOAD_OC} - \frac{I_{RIPPLE}}{2} \right) \times 8 \times R_{DS(ON)}}{I_{CS}}$$

Inductor current is monitored by the voltage between the GND and PHASE pins, so the PHASE pin should be connected to the Drain terminal of the low-side MOSFET. I_{CS} has a temperature coefficient to compensate the temperature dependency of the $R_{DS(ON)}$. GND is used as the positive current sensing node, so GND should be connected to the Source terminal of the low-side MOSFET.

As the comparison is being done during the OFF state, V_{LIMIT} (current limit threshold) sets the valley level of the inductor current. Thus, the load current at over current threshold, I_{LOAD_OC} , can be calculated as follows :

$$\begin{aligned} I_{LOAD_OC} &= \frac{V_{CS_OC}}{8 \times R_{DS(ON)}} + \frac{I_{RIPPLE}}{2} \\ &= \frac{V_{CS_OC}}{8 \times R_{DS(ON)}} + \frac{1}{2 \times L \times f} \times \frac{(V_{IN} - V_{OUT}) \times V_{OUT}}{V_{IN}} \end{aligned}$$

In an over current condition, the current to the load exceeds the current to the output capacitor. Thus, the output voltage falls and eventually crosses the under voltage protection threshold, inducing IC shutdown.

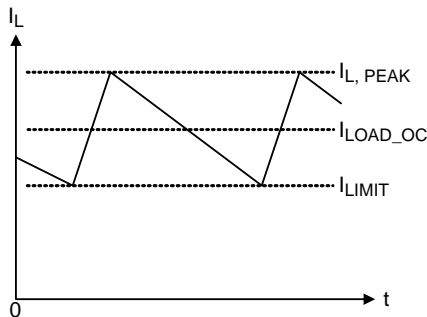

Figure 2. "Valley" Current Limit

When the device is operating in the FCCM, the negative current limit protects the external component. The negative current limit detect threshold is set as the same value as positive current limit but negative polarity. The threshold still is the valley value of the inductor current.

MOSFET Gate Driver

The high-side driver is designed to drive high current, low $R_{DS(ON)}$ N-MOSFET(s). When configured as a floating driver, 5V bias voltage is delivered from the VCC supply. The average drive current is proportional to the gate charge at $V_{GS} = 5V$ times switching frequency. The instantaneous drive current is supplied by the flying capacitor between the BOOT and PHASE pins. To prevent shoot through, a dead-time is internally generated between high-side MOSFET off to low-side MOSFET on, and low-side MOSFET off to high-side MOSFET on. The low-side driver is designed to drive high current low $R_{DS(ON)}$ N-MOSFET(s). The internal pull-down transistor that drives LGATE low is robust, with a 0.5Ω typical on-resistance. A 5V bias voltage is delivered from the VCC supply. The instantaneous drive current is supplied by the flying capacitor between VCC and GND.

For high current applications, certain combinations of high and low-side MOSFETs may cause excessive gate-drain coupling, which can lead to efficiency-killing, EMI-producing shoot-through currents. This is often remedied by adding a resistor in series with BOOT, which increases the turn-on time of the high-side MOSFET without degrading the turn-off time (see Figure 3).

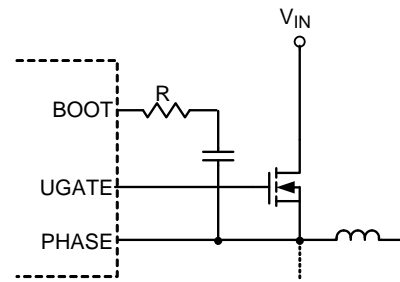

Figure 3. Reducing the UGATE Rise Time

Power Good Output (PGOOD)

The power good output is an open-drain output and requires a pull-up resistor. When the output voltage is 20% above or 10% below its set voltage, PGOOD will be pulled low. It is held low until the output voltage returns to within these tolerances once more. During soft-start, PGOOD is actively held low and is allowed to transition high only after soft-start is over and the output reaches 90% of its set voltage. There is a $2.5\mu s$ delay built into the PGOOD circuitry to prevent false transitions.

Output Over Voltage Protection (OVP)

The output voltage is continuously monitored for over voltage condition. When the output voltage exceeds 25% of its set voltage threshold, over voltage protection will be triggered and the low-side MOSFET is latched on. This activates the low-side MOSFET to discharge the output capacitor. The RT8237E is latched once OVP is triggered and can only be released by VCC or EN power on reset. There is a $5\mu s$ delay built into the over voltage protection circuit to prevent false transitions.

Output Under Voltage Protection (UVP)

The output voltage can be continuously monitored for under voltage condition. When the output voltage is less than 70% of its set voltage threshold, under voltage protection will be triggered and then both UGATE and LGATE gate drivers are forced low. There is a $2.5\mu s$ delay built into the under voltage protection circuit to prevent false transitions. During soft-start, the UVP blanking time is 3ms.

Thermal Shutdown (OTP)

The device implements an internal thermal shutdown to protect itself if junction temperature exceeds $150^\circ C$. When the junction temperature exceeds the thermal shutdown threshold that the OTP function will be triggered and the

RT8237E will shut down and enter Latch-Off Mode. In Latch-Off Mode, the RT8237E can be reset by EN or power input VCC.

Output Voltage Setting (FB)

The output voltage can be adjusted from 0.7V to 3.3V by setting the feedback resistors, R1 and R2 (see Figure 4). Choose R2 to be approximately 10kΩ and solve for R1 using the equation below :

$$V_{OUT} = V_{REF} \times \left(1 + \frac{R1}{R2}\right)$$

where V_{REF} is 0.704V (typ.).

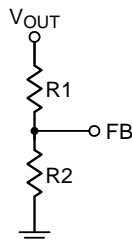

Figure 4. Setting V_{OUT} with a Resistive Voltage Divider

Inductor Selection

The inductor plays an important role in step-down converters because it stores the energy from the input power rail and then releases the energy to the load. From the viewpoint of efficiency, the dc resistance (DCR) of the inductor should be as small as possible to minimize the conduction loss. In addition, because the inductor takes up a significant portion of the board space, its size is also important. Low profile inductors can save board space especially when there is a height limitation. However, low DCR and low profile inductors are usually cost ineffective.

Additionally, larger inductance results in lower ripple current, which means lower power loss. The inductor current rising time increases with inductance value. This means the transient response will be slower. Therefore, the inductor design is a compromise between performance, size and cost.

In general, the inductance is designed such that the ripple current ranges between 20% to 40% of the full load current. The inductance can be calculated using the following equation :

$$L_{MIN} = \frac{V_{IN} - V_{OUT}}{f_{SW} \times k \times I_{OUT_rated}} \times \frac{V_{OUT}}{V_{IN}}$$

where k is the ratio between inductor ripple current and rated output current.

Input Capacitor Selection

Voltage rating and current rating are the key parameters in selecting an input capacitor. For a conservatively safe design, an input capacitor should generally have a voltage rating 1.5 times greater than the maximum input voltage.

The input capacitor is used to supply the input RMS current, which is approximately calculated using the following equation :

$$I_{RMS} = I_{OUT} \times \sqrt{\frac{V_{OUT}}{V_{IN}} \times \left(1 - \frac{V_{OUT}}{V_{IN}}\right)}$$

The next step is to select a proper capacitor for RMS current rating. Placing more than one capacitor with low Equivalent Series Resistance (ESR) in parallel to form a capacitor bank is a good design. Also, placing ceramic capacitor close to the Drain of the high-side MOSFET is helpful in reducing the input voltage ripple at heavy load.

Output Capacitor Selection

The output capacitor and the inductor form a low-pass filter in the buck topology. In steady-state condition, the ripple current that flows into or out of the capacitor results in ripple voltage. The output voltage ripples contains two components, ΔV_{OUT_ESR} and ΔV_{OUT_C}.

$$\Delta V_{OUT_ESR} = \Delta I_L \times ESR$$

$$\Delta V_{OUT_C} = \Delta I_L \times \frac{1}{8 \times C_{OUT} \times f_{SW}}$$

When load transient occurs, the output capacitor supplies the load current before the controller can respond. Therefore, the ESR will dominate the output voltage sag during load transient. The output voltage sag can be calculated using the following equation :

$$V_{OUT_sag} = ESR \times \Delta I_{OUT}$$

For a given output voltage sag specification, the ESR value can be determined.

Another parameter that has influence on the output voltage sag is the equivalent series inductance (ESL). A rapid change in load current results in di/dt during transient. Therefore, ESL contributes to part of the voltage sag. Use a capacitor that has low ESL to obtain better transient performance. Generally, using several capacitors in parallel will have better transient performance than using single capacitor for the same total ESR.

Unlike the electrolytic capacitor, the ceramic capacitor has relative low ESR and can reduce the voltage deviation during load transient. However, the ceramic capacitor can only provide low capacitance value. Therefore, use a mixed combination of electrolytic capacitor and ceramic capacitor for better transient performance.

MOSFET Selection

The majority of power loss in the step-down power conversion is due to the loss in the power MOSFETs. For low voltage high current applications, the duty cycle of the high-side MOSFET is small. Therefore, the switching loss of the high-side MOSFET is of concern. Power MOSFETs with lower total gate charge are preferred in such applications.

However, the small duty cycle means the low-side MOSFET is on for most of the switching cycle. Therefore, the conduction loss tends to dominate the total power loss of the converter. To improve the overall efficiency, MOSFETs with low $R_{DS(ON)}$ are preferred in circuit design. In some cases, more than one MOSFET are connected in parallel to further decrease the on-state resistance. However, this depends on the low-side MOSFET driver capability and the budget.

Thermal Considerations

The junction temperature should never exceed the absolute maximum junction temperature $T_{J(MAX)}$, listed under Absolute Maximum Ratings, to avoid permanent damage to the device. The maximum allowable power dissipation depends on the thermal resistance of the IC package, the PCB layout, the rate of surrounding airflow, and the difference between the junction and ambient temperatures. The maximum power dissipation can be calculated using the following formula :

$$P_{D(MAX)} = (T_{J(MAX)} - T_A) / \theta_{JA}$$

where $T_{J(MAX)}$ is the maximum junction temperature, T_A is the ambient temperature, and θ_{JA} is the junction-to-ambient thermal resistance.

For continuous operation, the maximum operating junction temperature indicated under Recommended Operating Conditions is 125°C. The junction-to-ambient thermal resistance, θ_{JA} , is highly package dependent. For a

WDFN-10L 3x3 package, the thermal resistance, θ_{JA} , is 30.5°C/W on a standard JEDEC 51-7 high effective-thermal-conductivity four-layer test board. The maximum power dissipation at $T_A = 25^\circ\text{C}$ can be calculated as below :

$$P_{D(MAX)} = (125^\circ\text{C} - 25^\circ\text{C}) / (30.5^\circ\text{C/W}) = 3.28\text{W for a WDFN-10L 3x3 package.}$$

The maximum power dissipation depends on the operating ambient temperature for the fixed $T_{J(MAX)}$ and the thermal resistance, θ_{JA} . The derating curves in Figure 5 allows the designer to see the effect of rising ambient temperature on the maximum power dissipation.

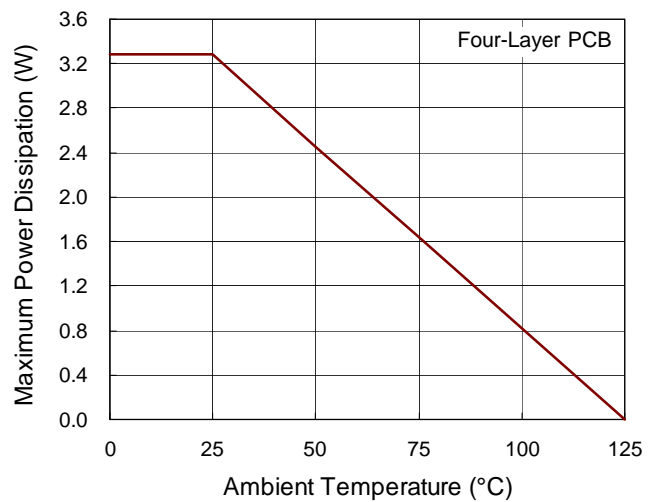

Figure 5. Derating Curve of Maximum Power Dissipation

Layout Considerations

Layout is very important in high frequency switching converter design. If designed improperly, the PCB may radiate excessive noise and contribute to converter instability. Certain points must be considered before starting a layout for the RT8237E.

- ▶ Connect an RC low pass filter for VCC; 1µF and 10Ω are recommended. Place the filter capacitor close to the IC.
- ▶ Keep current limit setting network as close to the IC as possible. Routing of the network should avoid coupling to high voltage switching node.
- ▶ Connections from the drivers to the respective gate of the high-side or the low-side MOSFET should be as short as possible to reduce stray inductance.

- ▶ All sensitive analog traces and components such as FB, GND, EN, CS, PGOOD, VCC, and RF should be placed away from high voltage switching nodes such as PHASE, LGATE, UGATE, or BOOT nodes to avoid coupling. Use internal layer(s) as ground plane(s) and shield the feedback trace from power traces and components.
- ▶ Current sense connections must always be made using Kelvin connections to ensure an accurate signal, with the current limit resistor located at the device.
- ▶ Power sections should connect directly to ground plane(s) using multiple vias as required for current handling (including the chip power ground connections). Power components should be placed close to the IC to minimize loops and reduce losses.

Outline Dimension

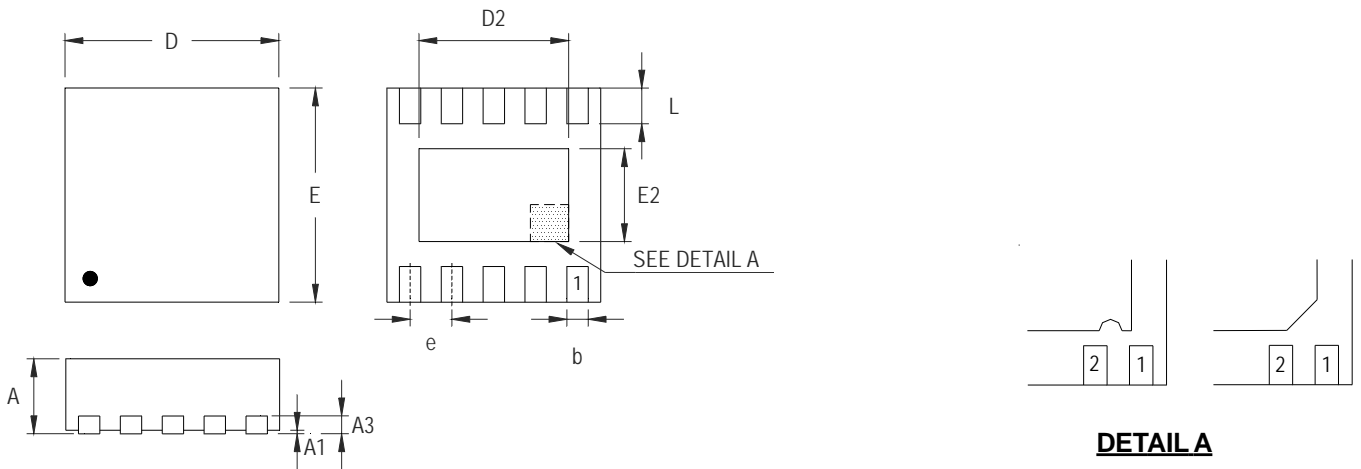

DETAIL A

Pin #1 ID and Tie Bar Mark Options

Note : The configuration of the Pin #1 identifier is optional, but must be located within the zone indicated.

Symbol	Dimensions In Millimeters		Dimensions In Inches	
	Min	Max	Min	Max
A	0.700	0.800	0.028	0.031
A1	0.000	0.050	0.000	0.002
A3	0.175	0.250	0.007	0.010
b	0.180	0.300	0.007	0.012
D	2.950	3.050	0.116	0.120
D2	2.300	2.650	0.091	0.104
E	2.950	3.050	0.116	0.120
E2	1.500	1.750	0.059	0.069
e	0.500		0.020	
L	0.350	0.450	0.014	0.018

W-Type 10L DFN 3x3 Package

Richtek Technology Corporation

14F, No. 8, Tai Yuen 1st Street, Chupei City
 Hsinchu, Taiwan, R.O.C.
 Tel: (8863)5526789



Richtek products are sold by description only. Richtek reserves the right to change the circuitry and/or specifications without notice at any time. Customers should obtain the latest relevant information and data sheets before placing orders and should verify that such information is current and complete. Richtek cannot assume responsibility for use of any circuitry other than circuitry entirely embodied in a Richtek product. Information furnished by Richtek is believed to be accurate and reliable. However, no responsibility is assumed by Richtek or its subsidiaries for its use; nor for any infringements of patents or other rights of third parties which may result from its use. No license is granted by implication or otherwise under any patent or patent rights of Richtek or its subsidiaries.

单击下面可查看定价，库存，交付和生命周期等信息

[>>Richtek\(台湾立锜\)](#)