

## 6A, 18V, 700kHz ACOT™ Synchronous Step-Down Converter with VID Control

### General Description

The RT6203F is an adaptive on-time mode synchronous Buck converter. The main control loop of the RT6203F uses an adaptive on-time mode control which provides a very fast transient response with no external components. The RT6203F operates from 4.5V to 18V VIN input. After the initial power-up, the output voltage can be changed by codes sent into the IC via an I<sup>2</sup>C compatible VID control bus. There are special codes which can be used to program current limit level and thermal shutdown level. Shutdown and startup can be also programmed by special codes. The device also features an internal soft-start time. Output voltage is adjustable by VID code setting. V<sub>OUT</sub> range is between 0.6V to 1.62V

### Pin Configuration

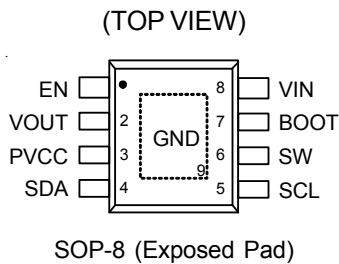

### Features

- VID Control Range Via I<sup>2</sup>C Compatible Interface :
  - 0.6V to 0.7V in 20mV Steps
  - 0.7V to 1.2V in 10mV Steps
  - 1.2V to 1.62V in 20mV Steps
- Adjustable Current Limit
- Adjustable Thermal Shutdown
- Fast Transient Response
- Steady 700kHz Switching Frequency
- Optimized for All Ceramic Capacitors
- Internal Soft-Start
- Input Under-Voltage Lockout
- Thermal Shutdown
- RoHS Compliant and Halogen Free

### Applications

- Industrial and Commercial Low Power Systems
- Computer Peripherals
- LCD Monitors and TVs
- Green Electronics/Appliances
- Point of Load Regulation for High-Performance DSPs, FPGAs, and ASICs

### Simplified Application Circuit

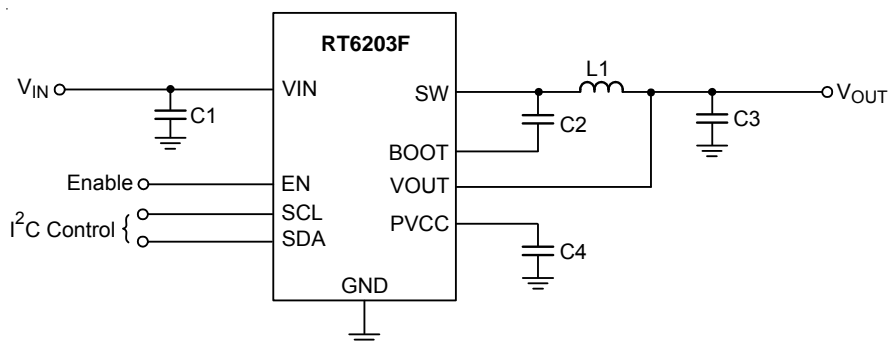

## Ordering Information

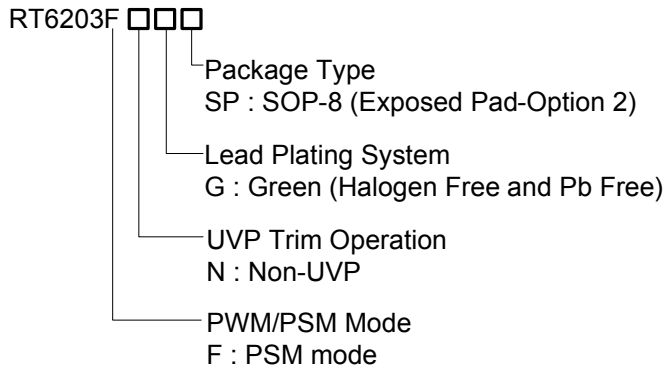

## Marking Information

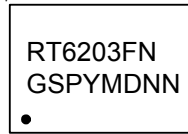

RT6203FNGSP : Product Number  
YMDNN : Date Code

Note :

Richtek products are :

- ▶ RoHS compliant and compatible with the current requirements of IPC/JEDEC J-STD-020.
- ▶ Suitable for use in SnPb or Pb-free soldering processes.

## Functional Pin Description

Pin No.	Pin Name	Pin Function
1	EN	Enable control input. Connect this pin to logic high can enable the device and connect this pin to GND can disable the device.
2	VOUT	Output voltage controlled by VID.
3	PVCC	5V power supply output. A capacitor (typical 1μF) should be connected to GND.
4	SDA	Data I/O pin.
5	SCL	Clock I/O pin.
6	SW	Switch output.
7	BOOT	Bootstrap. This capacitor is needed to drive the power switch's gate above the supply voltage. It is connected between SW and BOOT pins to form a floating supply across the power switch driver. A 0.1μF capacitor is recommended for use.
8	VIN	Power input and connected to high-side MOSFET drain.
9 (Exposed Pad)	GND	GND. The exposed pad must be soldered to a large PCB and connected to GND for maximum thermal dissipation.

**Functional Block Diagram**

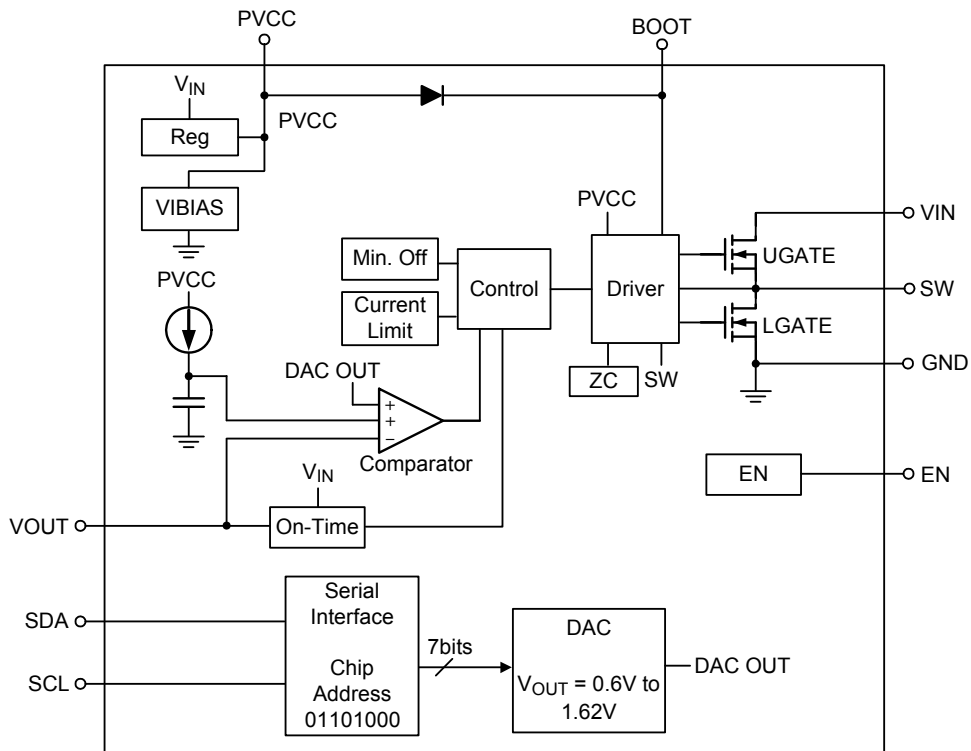

## Operation

The RT6203F is a high-efficiency, synchronous step-down DC-DC converter that can deliver up to 6A output current from a 4.5V to 18V input supply.

### Advanced Constant On-Time Control and PWM Operation

The RT6203F adopts ACOT™ control for its ultrafast transient response, low external component counts and stable with low ESR MLCC output capacitors. When the feedback voltage falls below the feedback reference voltage, the minimum off-time one-shot (230ns, typ.) has timed out and the inductor current is below the current limit threshold, then the internal on-time one-shot circuitry is triggered and the high-side switch is turn-on. Since the minimum off-time is short, the device exhibits ultrafast transient response and enables the use of smaller output capacitance.

The on-time is inversely proportional to input voltage and directly proportional to output voltage to achieve pseudo-fixed frequency over the input voltage range. After the on-time one-shot timer expired, the high-side switch is turn-off and the low-side switch is turn-on until the on-time one-shot is triggered again. To achieve stable operation with low-ESR ceramic output capacitors, an internal ramp signal is added to the feedback reference voltage to simulate the output voltage ripple.

### Power Saving Mode

The RT6203F automatically enters power saving mode (PSM) at light load to maintain high efficiency. As the load current decreases and eventually the inductor current ripple valley touches the zero current, which is the boundary between continuous conduction and discontinuous conduction modes. The low-side switch is turned off when the zero inductor current is detected. As the load current is further decreased, it takes longer time to discharge the output capacitor to the level that requires the next on-time. The switching frequency decreases and is proportional to the load current to maintain high efficiency at light load.

### Enable Control

The RT6203F provides an EN pin, as an external chip enable control, to enable or disable the device. If  $V_{EN}$  is held below a logic-low threshold voltage ( $V_{IL}$ ) of the enable input (EN), the converter will disable output voltage, that is, the converter is disabled and switching is inhibited even if the VIN voltage is above VIN under-voltage lockout threshold ( $V_{UVLO}$ ). During shutdown mode, the supply current can be reduced to  $I_{SHDN}$  (10µA or below). If the EN voltage rises above the logic-high threshold voltage ( $V_{IH}$ ) while the VIN voltage is higher than UVLO threshold, the device will be turned on, that is, switching being enabled and soft-start sequence being initiated. This EN pin is a high voltage pin and has an internal pull-high current to implement automatic start-up.

### Soft-Start (SS)

The RT6203F provides an internal soft-start feature for inrush control. At power up, the internal capacitor is charged by an internal current source to generate a soft-start ramp voltage as a reference voltage to the PWM comparator. The device will initiate switching and the output voltage will smoothly ramp up to its targeted regulation voltage only after this ramp voltage is greater than the target voltage to ensure the converters have a smooth start-up from pre-biased output. The output voltage starts to rise in 0.6ms from EN rising, and the soft-start ramp-up time ( $V_{OUT}$  from 0V to 0.95V) is 0.95ms.

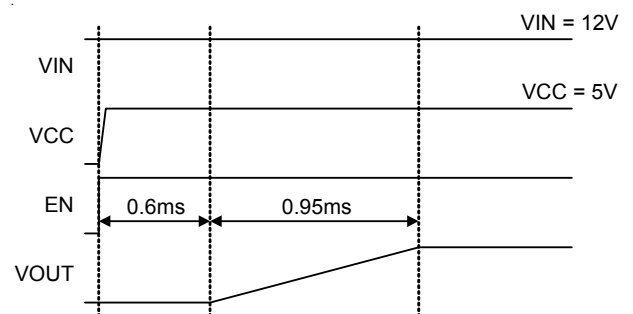

**Input Under-Voltage Lockout**

In addition to the EN pin, the RT6203F also provides enable control through the VIN pin. It features an under-voltage lockout (UVLO) function that monitors the internal linear regulator. If  $V_{EN}$  rises above  $V_{IH}$  first, switching will still be inhibited until the VIN voltage rises above  $V_{UVLO}$ . It is to ensure that the internal regulator is ready so that operation with not-fully-enhanced internal MOSFET switches can be prevented. After the device is powered up, if the input voltage VIN goes below the UVLO falling threshold voltage ( $V_{UVLO} - \Delta V_{UVLO}$ ), this switching will be inhibited; if VIN rises above the UVLO rising threshold ( $V_{UVLO}$ ), the device will resume normal operation with a complete soft-start.

**The Over-Current Protection**

The RT6203F features cycle-by-cycle current-limit protection on low-side MOSFETs and prevents the device from the catastrophic damage in output short circuit and over current.

The low-side MOSFET over-current protection is achieved by measuring the inductor current through the synchronous rectifier (low-side switch) during the low-side on-time. Once the current rises above the low-side switch valley current limit ( $I_{LIM\_L}$ ), the on-time one-shot will be inhibited until the inductor current ramps down to the current limit level ( $I_{LIM\_L}$ ), that is, another on-time can only be triggered when the inductor current goes below the low-side current limit. If the output load current exceeds the available inductor current (clamped by the low-side current limit), the output capacitor needs to supply the extra current such that the output voltage will begin to drop.

**Thermal Shutdown**

The RT6203F includes an over-temperature protection (OTP) circuitry to prevent overheating due to excessive power dissipation. The OTP will shut down switching operation when junction temperature exceeds a thermal shutdown threshold ( $T_{SD}$ ). Once the junction temperature cools down by a thermal shutdown hysteresis (20°C, typically), the IC will resume normal operation with a complete soft-start.

Note that the over temperature protection is intended to protect the device during momentary overload conditions.

The protection is activated outside of the absolute maximum range of operation as a secondary fail-safe and therefore should not be relied upon operationally. Continuous operation above the specified absolute maximum operating junction temperature may impair device reliability or permanently damage the device.

## Absolute Maximum Ratings (Note 1)

- Supply Voltage, VIN ----- -0.3V to 20V
- Switch Voltage, SW ----- -0.3V to 20.3V  
   <50ns ----- -5V to 25V
- BOOT Voltage ----- -0.3V to 26.3V
- Enable Voltage, EN ----- -0.3V to 20V
- BOOT to Switch Voltage, BOOT – SW ----- -0.3V to 6V
- Other Pins ----- -0.3V to 6V
- Power Dissipation, P<sub>D</sub> @ T<sub>A</sub> = 25°C  
   SOP-8 (Exposed Pad) ----- 3.44W
- Package Thermal Resistance (Note 2)  
   SOP-8 (Exposed Pad), θ<sub>JA</sub> ----- 29°C/W  
   SOP-8 (Exposed Pad), θ<sub>JC</sub> ----- 2°C/W
- Junction Temperature ----- 150°C
- Lead Temperature (Soldering, 10 sec.) ----- 260°C
- Storage Temperature Range ----- -65°C to 150°C
- ESD Susceptibility (Note 3)  
   HBM (Human Body Model) ----- 2kV

## Recommended Operating Conditions (Note 4)

- Supply Voltage, VIN ----- 4.5V to 18V
- Junction Temperature Range ----- -40°C to 125°C
- Ambient Temperature Range ----- -40°C to 85°C

## Electrical Characteristics

(V<sub>IN</sub> = 12V, T<sub>A</sub> = 25°C, unless otherwise specified)

Parameter		Symbol	Test Conditions	Min	Typ	Max	Unit
<b>Supply Current</b>							
Shutdown Current		I <sub>SHDN</sub>	V <sub>EN</sub> = 0V	--	1.5	10	μA
Shutdown Current by VID		I <sub>SHDN_VID</sub>	Special code = 1110110	--	75	105	μA
Quiescent Current		I <sub>Q</sub>	V <sub>EN</sub> = 2V, V <sub>FB</sub> = 1V	--	0.55	1.2	mA
<b>Logic Threshold</b>							
EN Input Voltage	Logic-Low	V <sub>IL</sub>		--	--	0.4	V
	Logic-High	V <sub>IH</sub>		1.6	--	--	
EN Pull-High Current				--	1	--	μA
<b>Output Voltage</b>							
Output Voltage		V <sub>OUT</sub>	RT6203F	0.94	0.95	0.96	V
Output Voltage		V <sub>OUT</sub>	I <sup>2</sup> C mode	Ideal V <sub>OUT</sub> -1.5%	Ideal V <sub>OUT</sub>	Ideal V <sub>OUT</sub> +1.5%	V
Minimum Output Voltage Rising Time per 10mV		V <sub>OUT</sub>	Special code = 1100001 (default) V <sub>OUT</sub> range between 0.7 to 1.2V	--	1	--	μs

Parameter	Symbol	Test Conditions	Min	Typ	Max	Unit
Maximum Output Voltage Rising Time per 10mV	V <sub>OUT</sub>	Special code = 1101000 V <sub>OUT</sub> range between 0.7 to 1.2V	--	8	--	μs
<b>VPVCC Output</b>						
V <sub>VPVCC</sub> Output Voltage	V <sub>VPVCC</sub>	6V = V <sub>IN</sub> = 18V, 0 < I <sub>VPVCC</sub> < 5mA	4.8	5	5.2	V
Line Regulation	ΔV <sub>LINE</sub>	6V = V <sub>IN</sub> = 18V, I <sub>VPVCC</sub> = 5mA	--	--	20	mV
Load Regulation	ΔV <sub>LOAD</sub>	0 < I <sub>VPVCC</sub> < 5mA	--	--	30	mV
Output Current	I <sub>VPVCC</sub>	V <sub>IN</sub> = 6V, V <sub>VPVCC</sub> = 4V	100	210	--	mA
<b>RDS(ON)</b>						
Switch-On Resistance	R <sub>D(S)ON_H</sub>	V <sub>BOOT</sub> – V <sub>SW</sub> = 5V	--	48	100	mΩ
	R <sub>D(S)ON_L</sub>		--	25	50	
<b>Current Limit</b>						
Low-Side Switch Current Limit	I <sub>LIM_L</sub>	Special code = 1110000 (default)	8.5	10	11.5	A
		Special code = 1110001	5.72	7.15	8.6	
		Special code = 1110010	3.44	4.3	5.16	
<b>On-Time Timer Control</b>						
Switching Frequency	f <sub>SW</sub>		--	700	--	kHz
Minimum On-Time	t <sub>ON_MIN</sub>		--	60	--	ns
Minimum Off-Time	t <sub>OFF_MIN</sub>		--	230	--	ns
<b>Soft-Start</b>						
Soft-Start Time	t <sub>SS</sub>		--	950	--	μs
<b>UVLO</b>						
UVLO Threshold	V <sub>UVLO</sub>	Wake up V <sub>VPVCC</sub>	3.55	3.85	4.15	V
	ΔV <sub>UVLO</sub>	Hysteresis	--	0.4	--	
<b>Thermal Shutdown</b>						
Thermal Shutdown Threshold	T <sub>SD</sub>	Special code = 1110011 (default)	--	150	--	°C
		Special code = 1110100	--	130	--	
		Special code = 1110101	--	170	--	

**Note 1.** Stresses beyond those listed under “Absolute Maximum Ratings” may cause permanent damage to the device. These are stress ratings only, and functional operation of the device at these or any other conditions beyond those indicated in the operational sections of the specifications is not implied. Exposure to absolute maximum rating conditions may affect device reliability.

**Note 2.** θ<sub>JA</sub> is measured under natural convection (still air) at T<sub>A</sub> = 25°C with the component mounted on a high effective-thermal-conductivity four-layer test board on a JEDEC 51-7 thermal measurement standard. θ<sub>JC</sub> is measured at the exposed pad of the package.

**Note 3.** Devices are ESD sensitive. Handling precaution is recommended.

**Note 4.** The device is not guaranteed to function outside its operating conditions.

## Typical Application Circuit

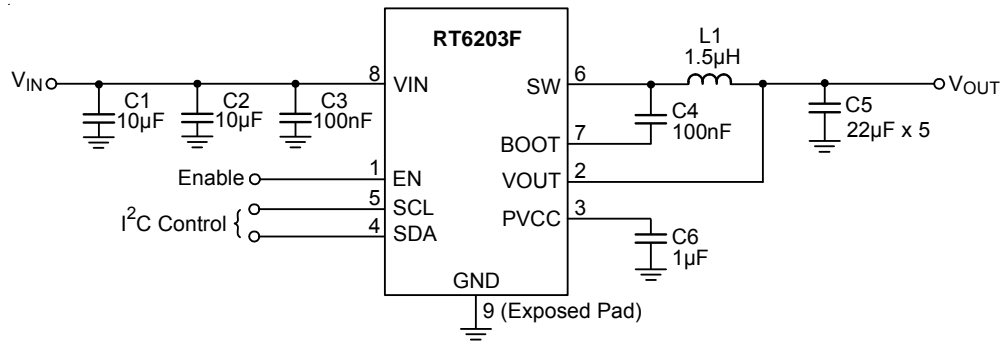

C1/C2 = GRM21BR61E106  
 L1 = WE744770015  
 C5 = GRM188R60J226



Typical Operating Characteristics

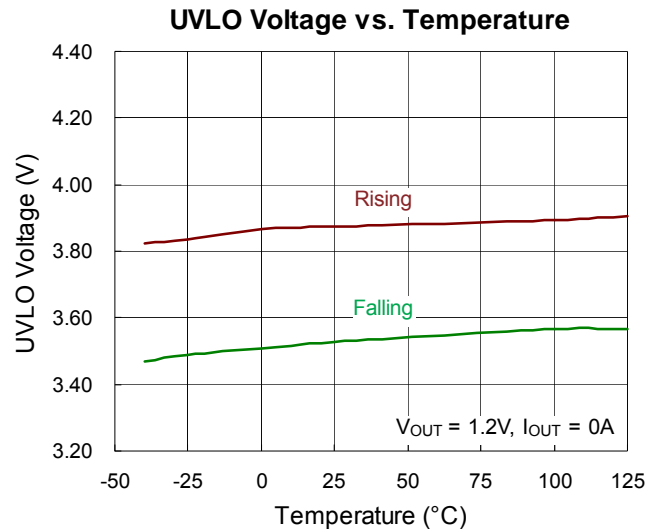
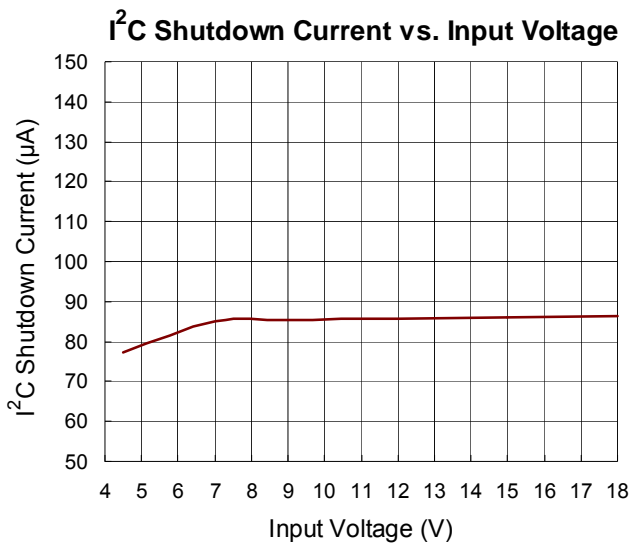
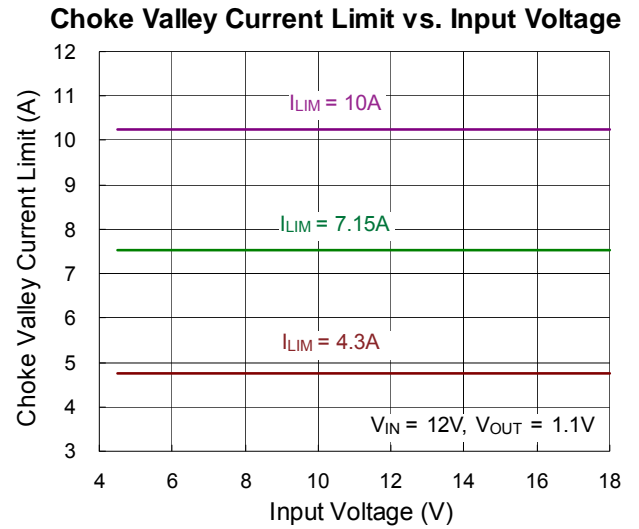
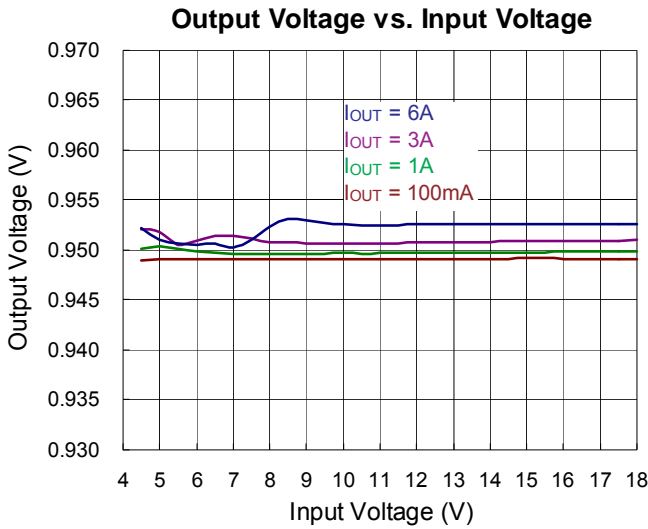
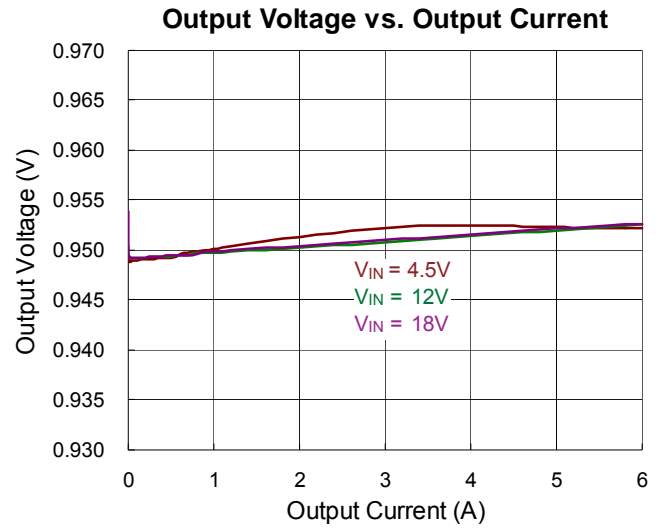
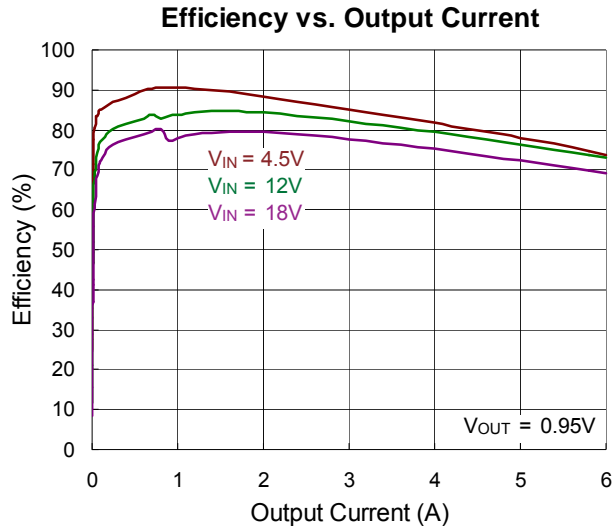

### EN Pin Threshold vs. Temperature

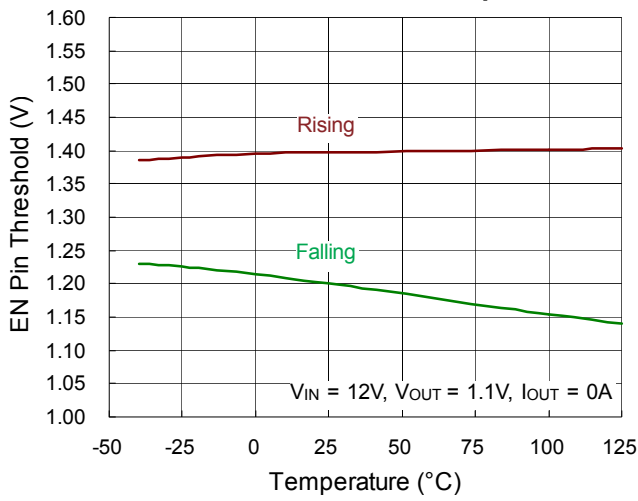

### Output Ripple

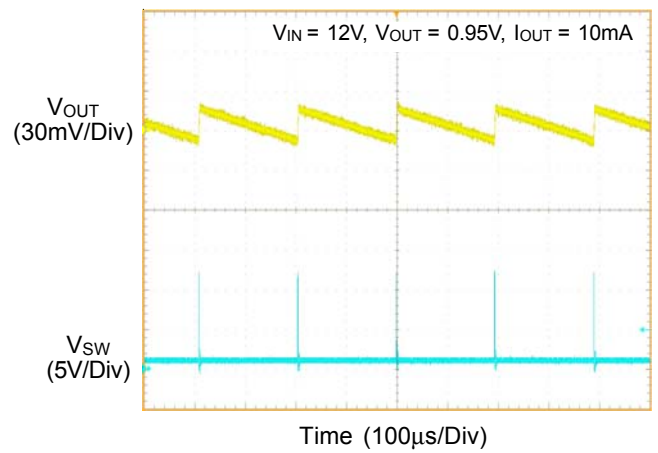

### Output Ripple

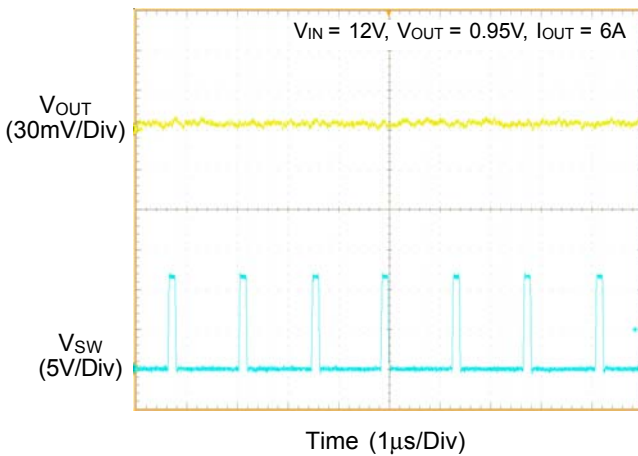

### Load Transient

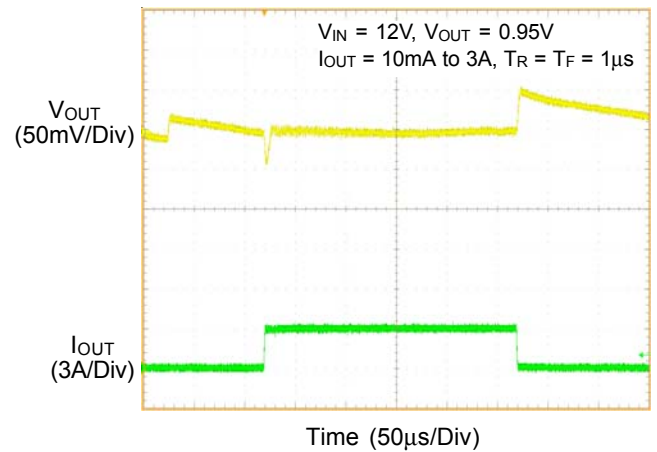

### Load Transient

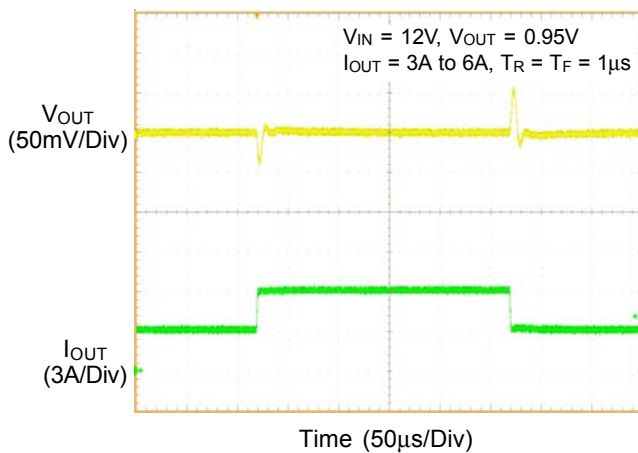

### Power On from EN

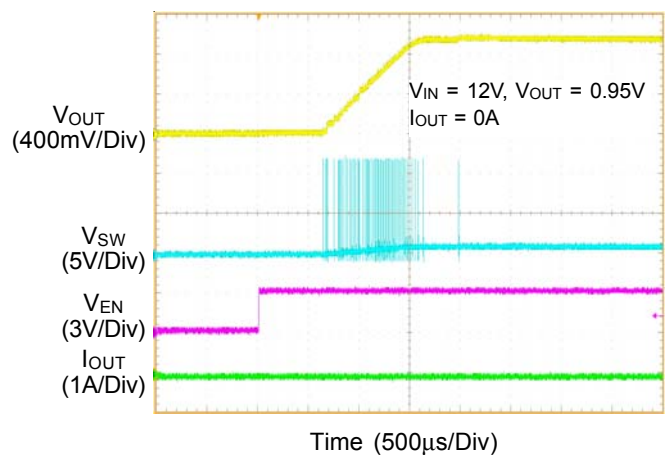

Power Off from EN

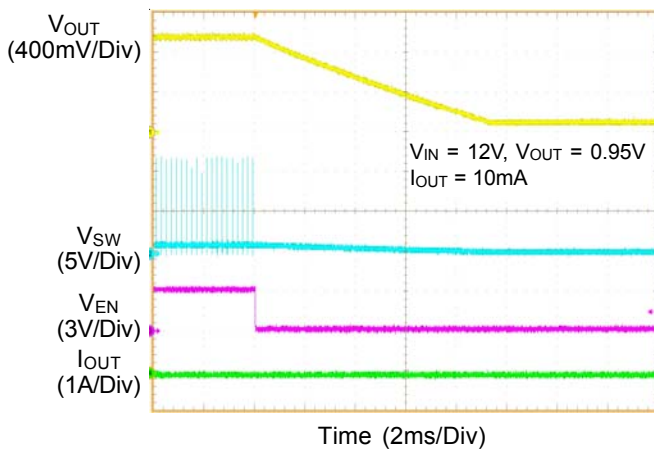

Power On from VIN

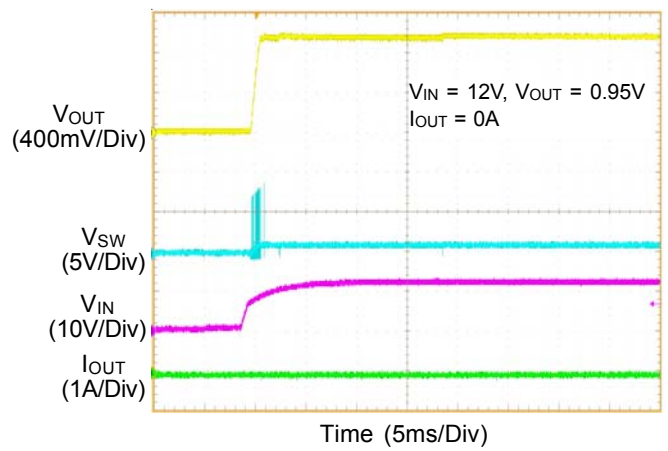

Power Off from VIN

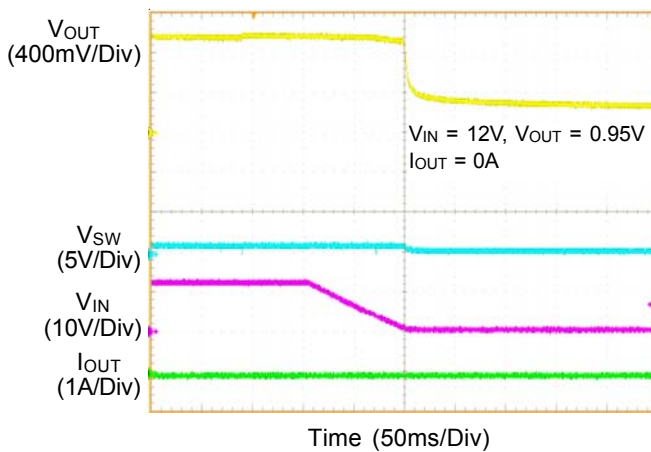

Power On than Short

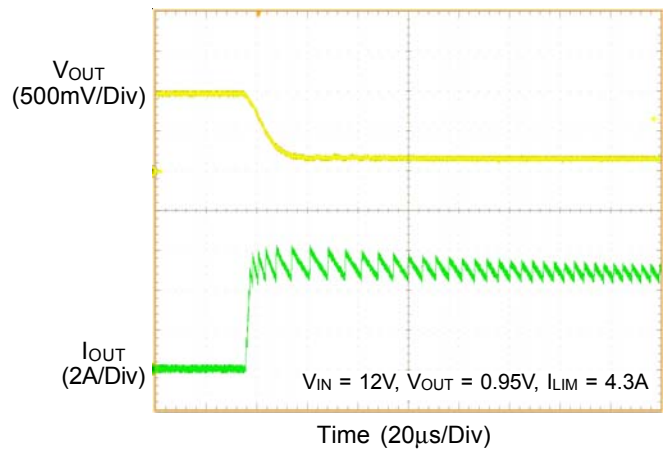

VID Rising

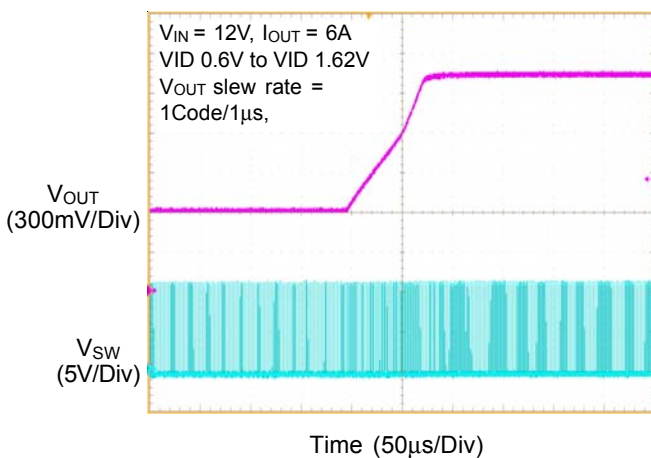

VID Falling

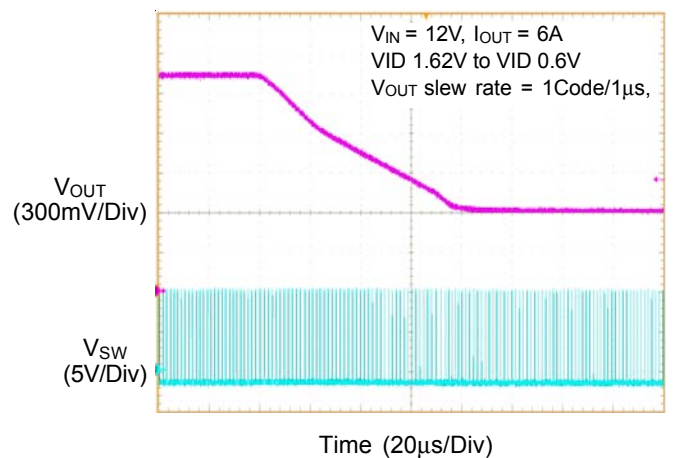

**Application Information**

**I<sup>2</sup>C Interface Function**

The RT6203F implements a subset of the I<sup>2</sup>C standard and provides a complete transaction command with a address byte followed by a single 8-bit data byte. Becasue there is no register address, the read function and multi-byte data transfer are not supported in this subset function. If the RT6203F fails to acknowledge for address byte or data byte, the master should issue a STOP command of ERROR and try again.

The 7-bit address of the RT6203F with a WRITE operation bit can become an 8 bits I<sup>2</sup>C address byte. (Address = 0b01101000). Table 1 is the structure of the RT6203F Data Byte. Bit0 to Bit6 are the 7-bit code for one of 77 output voltage and special function. After the soft-start time, Master can sent 8 bits data to control the V<sub>OUT</sub> of the RT6203F. The voltages can be selected from Table 2 and Table 3 shows how to use special function. The bit7 is check-sum bit and Master should set this bit to be the Exclusive-OR of [Bit6:Bit0]. In other words, the sum is even. If not, the RT6203F will not send an ACK bit.

**Table 1. Structure of the RT6203F Data Byte**

Bit7	Bit6	Bit5	Bit4	Bit3	Bit2	Bit1	Bit0
ChkSum	D6	D5	D4	D3	D2	D1	D0

**Table 2. VID Function**

Code	V <sub>OUT</sub>	Code	V <sub>OUT</sub>	Code	V <sub>OUT</sub>	Code	V <sub>OUT</sub>
0	0.6	10	0.75	20	0.85	30	0.95
1	0.62	11	0.76	21	0.86	31	0.96
2	0.64	12	0.77	22	0.87	32	0.97
3	0.66	13	0.78	23	0.88	33	0.98
4	0.68	14	0.79	24	0.89	34	0.99
5	0.7	15	0.8	25	0.9	35	1
6	0.71	16	0.81	26	0.91	36	1.01
7	0.72	17	0.82	27	0.92	37	1.02
8	0.73	18	0.83	28	0.93	38	1.03
9	0.74	19	0.84	29	0.94	39	1.04
Code	V <sub>OUT</sub>	Code	V <sub>OUT</sub>	Code	V <sub>OUT</sub>	Code	V <sub>OUT</sub>
40	1.05	50	1.15	60	1.3	70	1.5
41	1.06	51	1.16	61	1.32	71	1.52
42	1.07	52	1.17	62	1.34	72	1.54
43	1.08	53	1.18	63	1.36	73	1.56
44	1.09	54	1.19	64	1.38	74	1.58
45	1.1	55	1.2	65	1.4	75	1.6
46	1.11	56	1.22	66	1.42	76	1.62
47	1.12	57	1.24	67	1.44		
48	1.13	58	1.26	68	1.46		
49	1.14	59	1.28	69	1.48		

Table 3 shows special codes and relative function. Special codes are valid during the soft-start time.

1110000 to 1110010 : To change the over current limit level.

1110011 to 1110101 : To change the over-temperature protection level.

1110110 to 1110111 : To shut down and start up IC.

1100001 to 1101000 : To change the  $V_{OUT}$  slew rate.

**Table 3. Special Function**

Special Codes	Function
1110000	$I_{LIM} = 10A$ (default)
1110001	$I_{LIM} = 7.15A$
1110010	$I_{LIM} = 4.3A$
1110011	OT = 150°C (default)
1110100	OT = 130°C
1110101	OT = 170°C
1110110	Shutdown code
1110111	Start-up code
1100001	$V_{OUT}$ slew rate = Code /1 $\mu$ s (default)
1100010	$V_{OUT}$ slew rate = Code /2 $\mu$ s
1100011	$V_{OUT}$ slew rate = Code /3 $\mu$ s
1100100	$V_{OUT}$ slew rate = Code /4 $\mu$ s
1100101	$V_{OUT}$ slew rate = Code /5 $\mu$ s
1100110	$V_{OUT}$ slew rate = Code /6 $\mu$ s
1100111	$V_{OUT}$ slew rate = Code /7 $\mu$ s
1101000	$V_{OUT}$ slew rate = Code /8 $\mu$ s

The output stage of a synchronous buck converter is composed of an inductor and capacitor, which stores and delivers energy to the load, and forms a second-order low-pass filter to smooth out the switch node voltage to maintain a regulated output voltage.

### Inductor Selection

The inductor selection trade-offs among size, cost, efficiency, and transient response requirements. Generally, three key inductor parameters are specified for operation with the device: inductance value (L), inductor saturation current (I<sub>SAT</sub>), and DC resistance (DCR).

A good compromise between size and loss is to choose the peak-to-peak ripple current equals to 10% to 50% of the IC rated current. The switching frequency, input voltage, output voltage, and selected inductor ripple current determines the inductor value as follows :

$$L = \frac{V_{OUT} \times (V_{IN} - V_{OUT})}{V_{IN} \times f_{SW} \times \Delta I_L}$$

Once an inductor value is chosen, the ripple current ( $\Delta I_L$ ) is calculated to determine the required peak inductor current.

$$\Delta I_L = \frac{V_{OUT} \times (V_{IN} - V_{OUT})}{V_{IN} \times f_{SW} \times L} \text{ and } I_{L(PK)} = I_{OUT\_MAX} + \frac{\Delta I_L}{2}$$

I<sub>L(PK)</sub> should not exceed the minimum value of IC's upper current limit level. Besides, the current flowing through the inductor is the inductor ripple current plus the output current. During power up, faults or transient load conditions, the inductor current can increase above the calculated peak inductor current level calculated above. In transient conditions, the inductor current can increase up to the switch current limit of the device. For this reason, the most conservative approach is to specify an inductor with a saturation current rating equal to or greater than the switch current limit rather than the peak inductor current.

For more conservative, the rating for inductor saturation current must be equal to or greater than switch current limit of the device rather than the inductor peak current.

### Input Capacitor Selection

Input capacitance, C<sub>IN</sub>, is needed to filter the pulsating current at the drain of the high-side power MOSFET. C<sub>IN</sub> should be sized to do this without causing a large variation

in input voltage. The waveform of C<sub>IN</sub> ripple voltage and ripple current are shown in Figure 1. The peak-to-peak voltage ripple on input capacitor can be estimated as equation below :

$$\Delta V_{CIN} = D \times I_{OUT} \times \frac{1-D}{C_{IN} \times f_{SW}} + I_{OUT} \times ESR$$

where

$$D = \frac{V_{OUT}}{V_{IN} \times \eta}$$

For ceramic capacitors, the equivalent series resistance (ESR) is very low, the ripple which is caused by ESR can be ignored, and the minimum input capacitance can be estimated as equation below :

$$C_{IN\_MIN} = I_{OUT\_MAX} \times \frac{D(1-D)}{\Delta V_{CIN\_MAX} \times f_{SW}}$$

Where  $\Delta V_{CIN\_MAX} \leq 200mV$

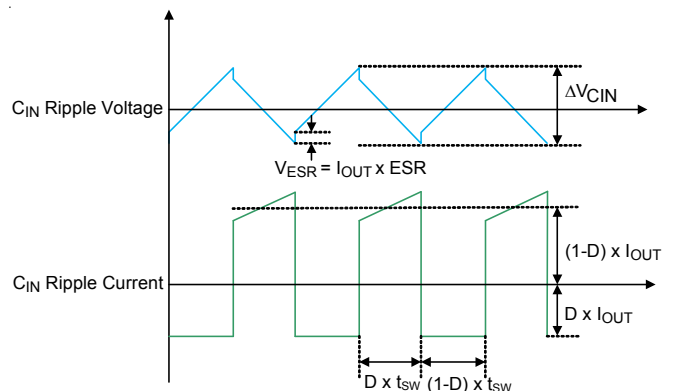

Figure 1. C<sub>IN</sub> Ripple Voltage and Ripple Current

In addition, the input capacitor needs to have a very low ESR and must be rated to handle the worst-case RMS input current of :

$$I_{RMS} \cong I_{OUT\_MAX} \times \frac{V_{OUT}}{V_{IN}} \times \sqrt{\frac{V_{IN}}{V_{OUT}} - 1}$$

It is commonly to use the worse  $I_{RMS} \cong I_{OUT}/2$  at  $V_{IN} = 2V_{OUT}$  for design. Note that ripple current ratings from capacitor manufacturers are often based on only 2000 hours of life which makes it advisable to further de-rate the capacitor, or choose a capacitor rated at a higher temperature than required.

Several capacitors may also be paralleled to meet size, height and thermal requirements in the design. For low input voltage applications, sufficient bulk input capacitance is needed to minimize transient effects during output load changes.

Ceramic capacitors are ideal for switching regulator applications due to its small, robust and very low ESR. However, care must be taken when these capacitors are used at the input. A ceramic input capacitor combined with trace or cable inductance forms a high quality (under damped) tank circuit. If the RT6203F circuit is plugged into a live supply, the input voltage can ring to twice its nominal value, possibly exceeding the device's rating. This situation is easily avoided by placing the low ESR ceramic input capacitor in parallel with a bulk capacitor with higher ESR to damp the voltage ringing.

The input capacitor should be placed as close as possible to the VIN pins, with a low inductance connection to the GND of the IC. In addition to a larger bulk capacitor, a small ceramic capacitors of 0.1µF should be placed close to the VIN and GND pin. This capacitor should be 0402 or 0603 in size.

**Output Capacitor Selection**

The RT6203F are optimized for ceramic output capacitors and best performance will be obtained using them. The total output capacitance value is usually determined by the desired output voltage ripple level and transient response requirements for sag (undershoot on load apply) and soar (overshoot on load release).

**Output Ripple**

The output voltage ripple at the switching frequency is a function of the inductor current ripple going through the output capacitor's impedance. To derive the output voltage ripple, the output capacitor with capacitance, C<sub>OUT</sub>, and its equivalent series resistance, R<sub>ESR</sub>, must be taken into consideration. The output peak-to-peak ripple voltage V<sub>RIPPLE</sub>, caused by the inductor current ripple ΔI<sub>L</sub>, is characterized by two components, which are ESR ripple V<sub>RIPPLE(ESR)</sub> and capacitive ripple V<sub>RIPPLE(C)</sub>, can be expressed as below :

$$V_{RIPPLE} = V_{RIPPLE(ESR)} + V_{RIPPLE(C)}$$

$$V_{RIPPLE(ESR)} = \Delta I_L \times R_{ESR}$$

$$V_{RIPPLE(C)} = \frac{\Delta I_L}{8 \times C_{OUT} \times f_{SW}}$$

If ceramic capacitors are used as the output capacitors, both the components need to be considered due to the extremely low ESR and relatively small capacitance.

**Output Transient Undershoot and Overshoot**

In addition to voltage ripple at the switching frequency, the output capacitor and its ESR also affect the voltage sag (undershoot) and soar (overshoot) when the load steps up and down abruptly. The ACOT™ transient response is very quick and output transients are usually small. The following section shows how to calculate the worst-case voltage swings in response to very fast load steps.

The output voltage transient undershoot and overshoot each have two components : the voltage steps caused by the output capacitor's ESR, and the voltage sag and soar due to the finite output capacitance and the inductor current slew rate. Use the following formulas to check if the ESR is low enough (typically not a problem with ceramic capacitors) and the output capacitance is large enough to prevent excessive sag and soar on very fast load step edges, with the chosen inductor value.

The amplitude of the ESR step up or down is a function of the load step and the ESR of the output capacitor :

$$V_{ESR\_STEP} = \Delta I_{OUT} \times R_{ESR}$$

The amplitude of the capacitive sag is a function of the load step, the output capacitor value, the inductor value, the input-to-output voltage differential, and the maximum duty cycle. The maximum duty cycle during a fast transient is a function of the on-time and the minimum off-time since the ACOT™ control scheme will ramp the current using on-times spaced apart with minimum off-times, which is as fast as allowed. Calculate the approximate on-time (neglecting parasites) and maximum duty cycle for a given input and output voltage as :

$$t_{ON} = \frac{V_{OUT}}{V_{IN} \times f_{SW}} \text{ and } D_{MAX} = \frac{t_{ON}}{t_{ON} + t_{OFF\_MIN}}$$

The actual on-time will be slightly longer as the IC compensates for voltage drops in the circuit, but we can neglect both of these since the on-time increase compensates for the voltage losses. Calculate the output voltage sag as :

$$V_{SAG} = \frac{L \times (\Delta I_{OUT})^2}{2 \times C_{OUT} \times (V_{IN(MIN)} \times D_{MAX} - V_{OUT})}$$

The amplitude of the capacitive soar is a function of the load step, the output capacitor value, the inductor value and the output voltage :

$$V_{SOAR} = \frac{L \times (\Delta I_{OUT})^2}{2 \times C_{OUT} \times V_{OUT}}$$

Due to some modern digital loads can exhibit nearly instantaneous load changes, the amplitude of the ESR step up or down should be taken into consideration.

### Enable Operation (EN)

EN is a high voltage input pin. For automatic start-up, the EN pin can be connected to VIN directly. The inherent hysteresis makes EN useful as a simple timing delay. To add an additional time delay, the EN pin can be connected to GND through a capacitor C<sub>EN</sub>, as shown in Figure 2. The additional time delay for switching operation to start can be calculated with the EN's internal logic threshold. (typically 2V).

An external MOSFET can be added to implement an logic-controlled EN pin, as shown in Figure 3. The MOSFET Q1 can provide the logic control on the EN pin, pulling it down. To prevent enabling circuit when V<sub>IN</sub> is smaller than the V<sub>OUT</sub> target value or some other desired voltage level, a resistive divider can be placed to control the EN voltage as the additional input under voltage lockout function, as shown in Figure 4.

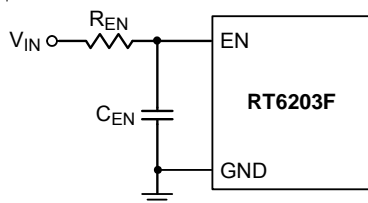

Figure 2. Enable Timing Control

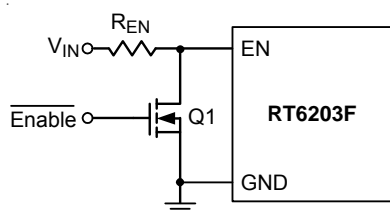

Figure 3. Logic Control for the EN Pin

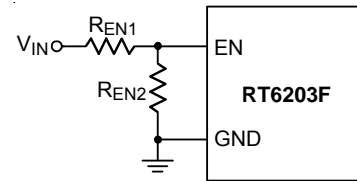

Figure 4. Resistor Divider for Lockout Threshold Setting

### External Bootstrap Diode

Connect a 0.1μF low ESR ceramic capacitor between the BOOT and SW pins. This capacitor provides the gate driver voltage for the high-side MOSFET. It is recommended to add an external bootstrap diode between an external 5V and BOOT pin for efficiency improvement when input voltage is lower than 5.5V. The bootstrap diode can be a low cost one such as IN4148 or BAT54. The external 5V can be a 5V fixed input from system or a 5V output of the RT6203F. Note that the external boot voltage must be lower than 5.5V.

### External BOOT Capacitor Series Resistor

The internal power MOSFET gate driver is not only optimized to turn the switch on fast enough to minimize switching loss, but also slow enough to reduce EMI. Since the switch rapidly turn-on will induce high di/dt noise which let EMI issue much worse. During switch turn-off, SW is discharged relatively slowly by the inductor current during the dead time between high-side and low-side switch on-times. In some cases it is desirable to reduce EMI further, at the expense of some additional power dissipation. The switch turn-on can be slowed by placing a small (<47Ω) resistance between BOOT and the external bootstrap capacitor. This will slow the high-side switch turn-on speed and V<sub>SW</sub>'s rise. The recommended external diode connection is shown in Figure 5, using external diode to charge the BOOT capacitor, and place a resistor between BOOT and the capacitor/diode connection to reduce turn-on speed for any EMI issue consideration.



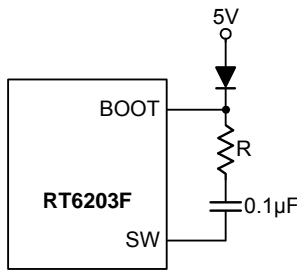

Figure 5. External Bootstrap Diode and BOOT Capacitor Series Resistor

**Thermal Considerations**

In many applications, the RT6203F does not generate much heat due to its high efficiency and low thermal resistance of its SOP-8 package. However, in applications in which the RT6203F is running at a high ambient temperature and high input voltage, the generated heat may exceed the maximum junction temperature of the part.

The RT6203F includes a programmable over-temperature protection (OTP) circuitry to prevent overheating due to excessive power dissipation. If the junction temperature reaches approximately 150°C(default), the RT6203F stop switching the power MOSFETs until the temperature drops about 20°C cooler.

Note that the over temperature protection is intended to protect the device during momentary overload conditions. The protection is activated outside of the absolute maximum range of operation as a secondary fail-safe and therefore should not be relied upon operationally. Continuous operation above the specified absolute maximum operating junction temperature may impair device reliability or permanently damage the device.

The maximum power dissipation can be calculated by the following formula :

$$P_{D(MAX)} = (T_{J(MAX)} - T_A) / \theta_{JA(EFFECTIVE)}$$

where  $T_{J(MAX)}$  is the maximum allowed junction temperature of the die. For recommended operating condition specifications, the maximum junction temperature is 125°C.  $T_A$  is the ambient operating temperature,  $\theta_{JA(EFFECTIVE)}$  is the system-level junction to ambient thermal resistance. It can be estimated from thermal modeling or measurements in the system.

The device thermal resistance depends strongly on the

surrounding PCB layout and can be improved by providing a heat sink of surrounding copper ground. The addition of backside copper with thermal vias, stiffeners, and other enhancements can also help reduce thermal resistance.

As an example, consider the case when the RT6203F is used in applications where  $V_{IN} = 12V$ ,  $I_{OUT} = 6A$ ,  $f_{SW} = 700kHz$ ,  $V_{OUT} = 0.95V$ . The efficiency at 0.95V, 6A is 73.1% by using WE -744770015 (1.5µH, 5mΩ DCR) as the inductor and measured at room temperature. The core loss can be obtained from its website of 35.1mW in this case. In this case, the power dissipation of the RT6203F is

$$P_{D, RT} = \frac{1-\eta}{\eta} \times P_{OUT} - (I_O^2 \times DCR + P_{CORE}) = 1.88W$$

Considering the system-level  $\theta_{JA(EFFECTIVE)}$  is 34.8°C/W (other heat sources are also considered), the junction temperature of the regulator operating in a 25°C ambient temperature is approximately :

$$T_J = 1.88W \times 34.8°C/W + 25°C = 90.5°C$$

Figure 6 shows the RT6203F  $R_{DS(ON)}$  versus different junction temperature. If the application calls for a higher ambient temperature, we might recalculate the device power dissipation and the junction temperature based on a higher  $R_{DS(ON)}$  since it increases with temperature.

Using 50°C ambient temperature as an example. Due to the variation of junction temperature is dominated by the ambient temperature, the  $T_J'$  at 50°C ambient temperature can be pre-estimated as

$$T_J' = 90.5°C + (50°C - 25°C) = 115.5°C$$

According to Figure 6, the increasing  $R_{DS(ON)}$  can be found as

$$\Delta R_{DS(ON)_H} = 61.8m\Omega \text{ (at } 115.5°C) - 56.7m\Omega \text{ ( } 90.5°C) = 5.1m\Omega$$

$$\Delta R_{DS(ON)_L} = 28.1m\Omega \text{ (at } 115.5°C) - 25.7m\Omega \text{ ( } 90.5°C) = 2.4m\Omega$$

The external power dissipation caused by the increasing  $R_{DS(ON)}$  at higher temperature can be calculated as

$$\Delta P_{D,RDS(ON)} = (6A)^2 \times \frac{0.95}{12} \times 5.1m\Omega + (6A)^2 \times \left(1 - \frac{0.95}{12}\right) \times 2.4m\Omega = 0.094W$$

As a result, the new power dissipation due to the variation of  $R_{DS(ON)}$  is 1.976W. Therefore, the estimated new junction temperature is

$$T_J' = 1.976W \times 34.8°C/W + 50°C = 118.8°C$$

If the application calls for a higher ambient temperature and may exceed the recommended maximum junction temperature of 125°C, care should be taken to reduce the temperature rise of the part by using a heat sink or air flow.

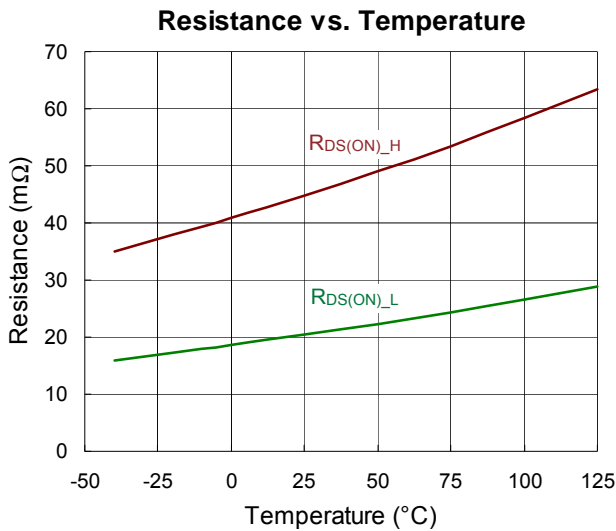

Figure 6. RT6203F R<sub>DS(ON)</sub> vs. Temperature

### Layout Considerations

Follow the PCB layout guidelines for optimal performance of the device.

- ▶ Keep the high-current paths short, especially at the ground terminals. This practice is essential for stable, jitter-free operation. The high current path comprising of input capacitor, high-side FET, inductor, and the output capacitor should be as short as possible. This practice is essential for high efficiency.
- ▶ Place the input MLCC capacitors as close to the VIN and GND pins as possible. The major MLCC capacitors should be placed on the same layer as the RT6203F.
- ▶ SW node is with high frequency voltage swing and should be kept at small area. Keep analog components away from the SW node to prevent stray capacitive noise pickup.
- ▶ Connect feedback network behind the output capacitors. Place the feedback components next to the FB pin.
- ▶ For better thermal performance, to design a wide and thick plane for GND pin or to add a lot of vias to GND plane.

An example of PCB layout guide is shown from Figure 7.

Four-layer or six-layer PCB with maximum ground plane is strongly recommended for good thermal performance.

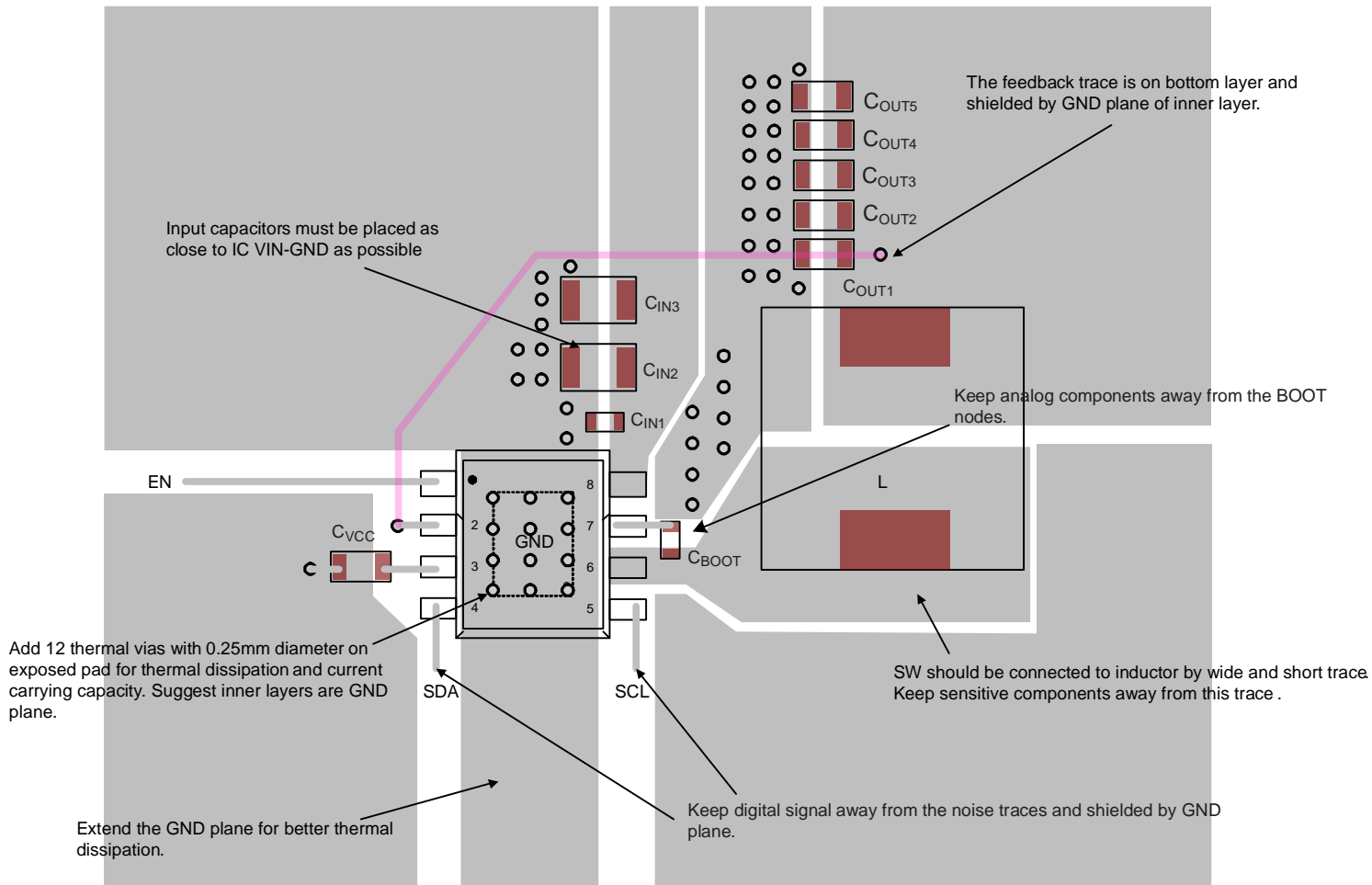
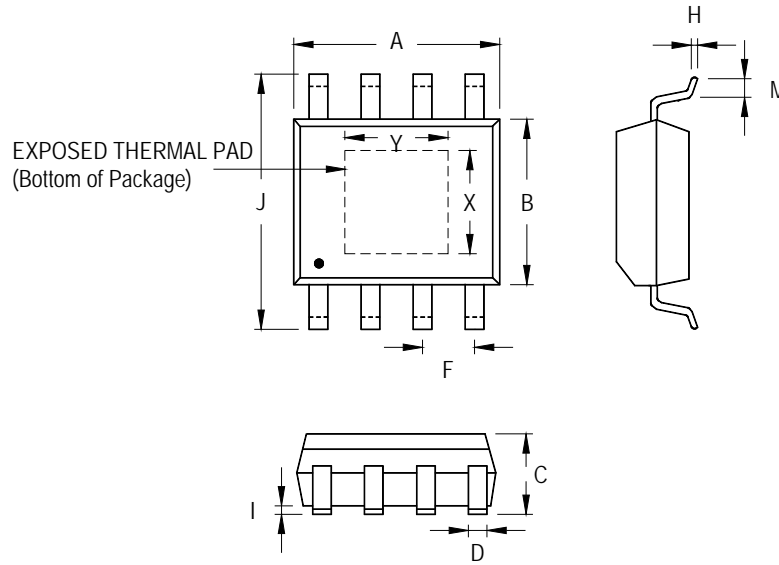

Figure 7. PCB Layout Guide

Outline Dimension



Symbol	Dimensions In Millimeters		Dimensions In Inches		
	Min	Max	Min	Max	
A	4.801	5.004	0.189	0.197	
B	3.810	4.000	0.150	0.157	
C	1.346	1.753	0.053	0.069	
D	0.330	0.510	0.013	0.020	
F	1.194	1.346	0.047	0.053	
H	0.170	0.254	0.007	0.010	
I	0.000	0.152	0.000	0.006	
J	5.791	6.200	0.228	0.244	
M	0.406	1.270	0.016	0.050	
Option 1	X	2.000	2.300	0.079	0.091
	Y	2.000	2.300	0.079	0.091
Option 2	X	2.100	2.500	0.083	0.098
	Y	3.000	3.500	0.118	0.138

8-Lead SOP (Exposed Pad) Plastic Package

**Footprint Information**

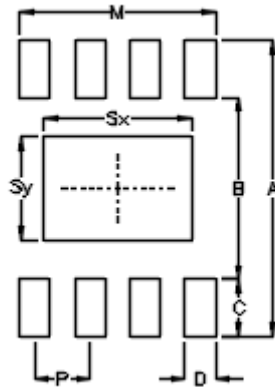

Package		Number of Pin	Footprint Dimension (mm)								Tolerance
			P	A	B	C	D	Sx	Sy	M	
PSOP-8	Option1	8	1.27	6.80	4.20	1.30	0.70	2.30	2.30	4.51	±0.10
	Option2							3.40	2.40		

**Richtek Technology Corporation**

14F, No. 8, Tai Yuen 1<sup>st</sup> Street, Chupei City  
 Hsinchu, Taiwan, R.O.C.  
 Tel: (8863)5526789

Richtek products are sold by description only. Customers should obtain the latest relevant information and data sheets before placing orders and should verify that such information is current and complete. Richtek cannot assume responsibility for use of any circuitry other than circuitry entirely embodied in a Richtek product. Information furnished by Richtek is believed to be accurate and reliable. However, no responsibility is assumed by Richtek or its subsidiaries for its use; nor for any infringements of patents or other rights of third parties which may result from its use. No license is granted by implication or otherwise under any patent or patent rights of Richtek or its subsidiaries.

单击下面可查看定价，库存，交付和生命周期等信息

[>>Richtek\(台湾立锜\)](#)