

RT7295CGJ6F Evaluation Board

Purpose

The RT7295C is a synchronous step-down converter with Advanced Constant On-Time (ACOT™) mode control. It can deliver up to 3.5A output current from a wide input voltage range of 4.3V to 18V. This document explains the function and use of the RT7295C evaluation board (EVB) and provides information to enable operation and modification of the evaluation board and circuit to suit individual requirements.

Table of Contents

PURPOSE.....	1
INTRODUCTION.....	2
KEY PERFORMANCE SUMMARY TABLE.....	2
BENCH TEST SETUP CONDITIONS.....	3
SCHEMATIC, BILL OF MATERIALS AND BOARD LAYOUT.....	5
MORE INFORMATION.....	10
IMPORTANT NOTICE FOR RICHTEK REFERENCE DESIGNS.....	10

Introduction

General Product Information

The RT7295C is a synchronous step-down converter with Advanced Constant On-Time (ACOT™) mode control. The ACOT™ provides a very fast transient response with few external components. The low impedance internal MOSFET supports high efficiency operation with wide input voltage range from 4.3V to 18V. The proprietary circuit of the RT7295C enables to support all ceramic capacitors. The output voltage can be adjusted between 0.6V and 8V. The RT7295C also provides output under voltage protection and thermal shutdown protection. The low current (<4μA) shutdown mode provides output disconnection, enabling easy power management in battery-powered systems. The RT7295C is available in TSOT-23-6 FCOL (Flip-Chip-On-Lead) package.

Product Feature

- ±1.5% High Accuracy Feedback Voltage
- 4.3V to 18V Input Voltage Range
- 3.5A Output Current
- Integrated N-MOSFET Switches
- ACOT™ mode control
- Fixed Frequency Operation : 500kHz
- Output Adjustable from 0.6V to 8V
- Up to 95% Efficiency
- Fast Transient Response
- Stable with Low-ESR Ceramic Output Capacitors
- Cycle-by-Cycle Over Current Protection
- Input Under Voltage Lockout
- Output Under Voltage Protection
- Thermal Shutdown Protection
- Thermal Improve FCOL package (Flip Chip On Lead)
- RoHS Compliant and Halogen Free

Key Performance Summary Table

Key Features	Evaluation Board Number: PCB007_V1
Default Input Voltage	12V
Max Output Current	3.5A
Default Output Voltage	1.2V
Default Marking & Package Type	RT7295CGJ6F, TSOT-23-6 (FCOL)
Operation Frequency	Steady 500kHz at all loads
Other Key Features	ACOT™ for Fast Transient Response FCOL for Thermal & Efficiency Improvement
Protection	Output Under-Voltage Protection (hiccup mode): Cycle-by-cycle Current Limit Thermal Shutdown

Bench Test Setup Conditions

Headers Description and Placement

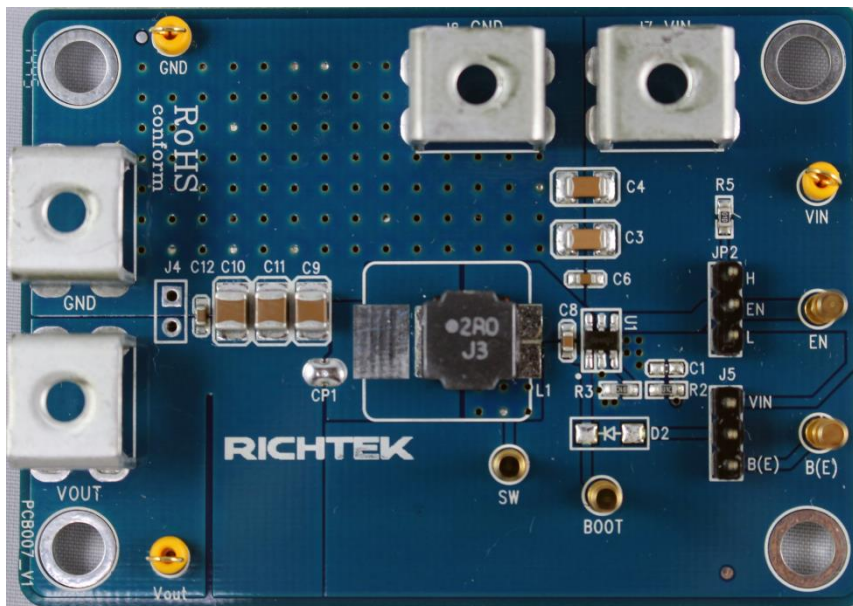

Please carefully inspect the EVB IC and external components, comparing them to the following Bill of Materials, to ensure that all components are installed and undamaged. If any components are missing or damaged during transportation, please contact the distributor or send e-mail to evb_service@richtek.com

Test Points

The EVB is provided with the test points and pin names listed in the table below.

Test point/ Pin name	Signal	Comment (expected waveforms or voltage levels on test points)
VIN	Input voltage	Input voltage range= 4.3V to 18V
VOUT	Output voltage	Default output voltage = 1.2V Output voltage range= 0.6V to 8V (see " Output Voltage Setting" section for changing output voltage level)
SW	Switching node test point	SW waveform
EN	Enable test point	Enable signal. Drive EN or install a shorting block on Jumper JP2 to enable operation or disable operation.
JP2	Chip enable control	Install jumper or drive EN directly to enable or disable operation
BOOT	Boot strap supply test point	Floating supply voltage for the high-side N-MOSFET switch
GND	Ground	Ground

Power-up & Measurement Procedure

1. Apply a 12V nominal input power supply ($4.3V < V_{IN} < 18V$) to the VIN and GND terminals.
2. The EN voltage is pulled to logic high by R5 (100kΩ to VIN) to enable operation. Drive EN high (>1.5V) to enable operation or low (<0.4V) to disable operation.
3. Verify the output voltage (approximately 1.2V) between VOUT and GND.
4. Connect an external load up to 3.5A to the VOUT and GND terminals and verify the output voltage and current.

Output Voltage Setting

Set the output voltage with the resistive divider (R2, R3) between VOUT and GND with the midpoint connected to FB. The output is set by the following formula:

$$V_{OUT} = 0.6 \times \left(1 + \frac{R2}{R3}\right)$$

The installed VOUT capacitors (C9, C10 and C11) are 22 μ F, 16V X5R ceramic types. Do not exceed their operating voltage range and consider their voltage coefficient (capacitance vs. bias voltage) and ensure that the capacitance is sufficient to maintain stability and provide sufficient transient response for your application. This can be verified by checking the output transient response as described in the RT7295C IC datasheet.

Schematic, Bill of Materials & Board Layout

EVB Schematic Diagram

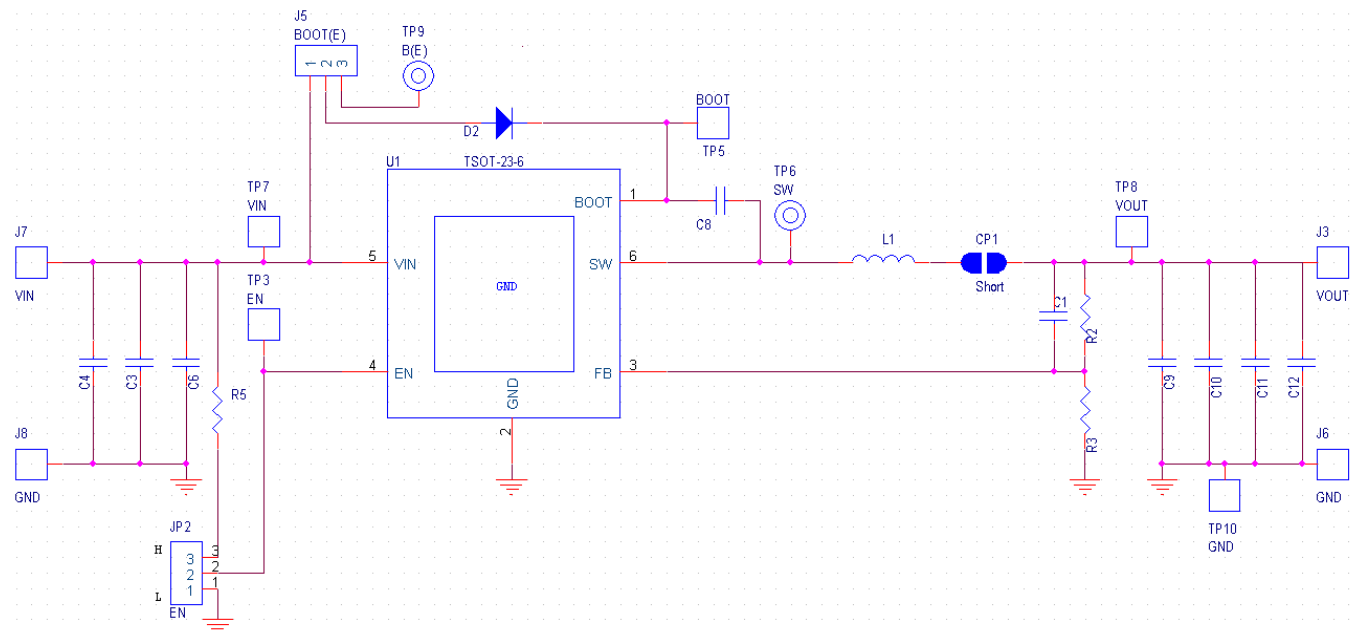

C3, C4: 10 μ F/50V/X5R, 1206, TDK C3216X5R1H106K
 C9, C10, C11: 22 μ F/16V/X5R, 1210, Murata GRM32ER61C226K
 L1: 2 μ H TAIYO YUDEN NR8040T2R0N, DCR=9m Ω

Bill of Materials

Reference	Qty	Part number	Description	Package	Manufacture
U1	1	RT7295CGJ6F	DC-DC Converter	TSOT-23-6 (FC)	RICHTEK
C3, C4	2	C3216X5R1H106K160AB	10uF/±10%/50V/X5R Ceramic Capacitor	1206	TDK
C9, C10, C11	3	GRM32ER61C226KE20#	22uF/±10%/16V/X5R Ceramic Capacitor	1210	Murata
C6, C8, C12	3	C1608X7R1H104K080AA	0.1uF/±10%/50V/X7R Ceramic Capacitor	0603	TDK
C1, D2	0		Not Installed	0603	
L1	1	NR8040T2R0N	2.0uH/7.4A/±30%, DCR=9mΩ, Inductor	8mmx8mmx4mm	TAIYO YUDEN
R2	1		10kΩ/±1%, Resistor	0603	
R3	1		10kΩ/±1%, Resistor	0603	
R5	1		100kΩ/±1%, Resistor	0603	
CP1	1		Short		
JP2, J5	2		3-Pin Header		
GP	4	EN, B(E), BOOT, SW	Golden Pin		
TP	3	Vout, GND, VIN	Test Pin		
J3, J6, J7, J8	4	VIN, VOUT, GND, GND	Test Pin		

EVB Layout

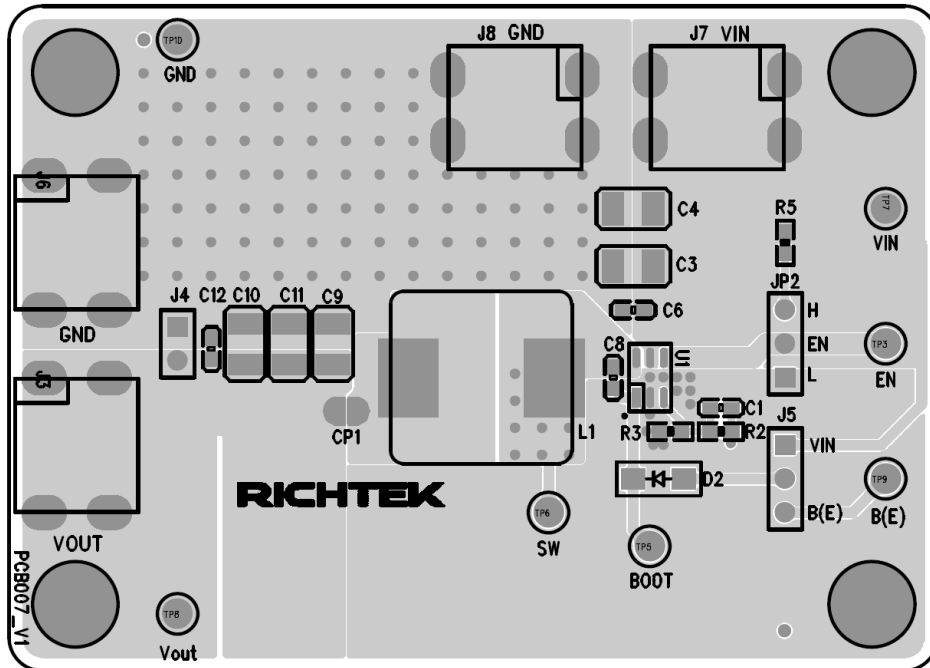

Top View (1st layer)

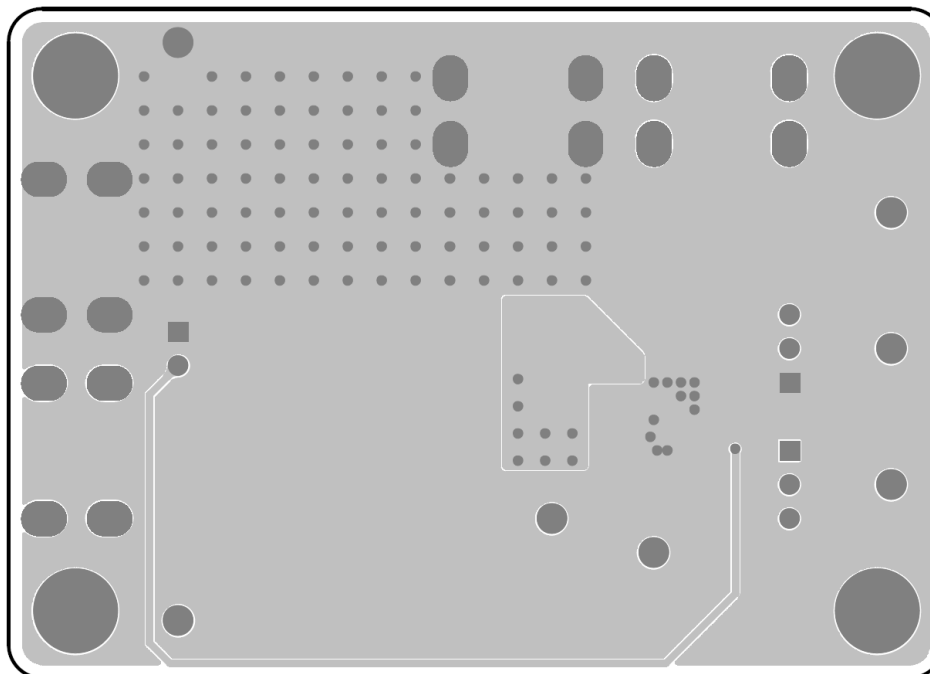

Bottom View (4th Layer)

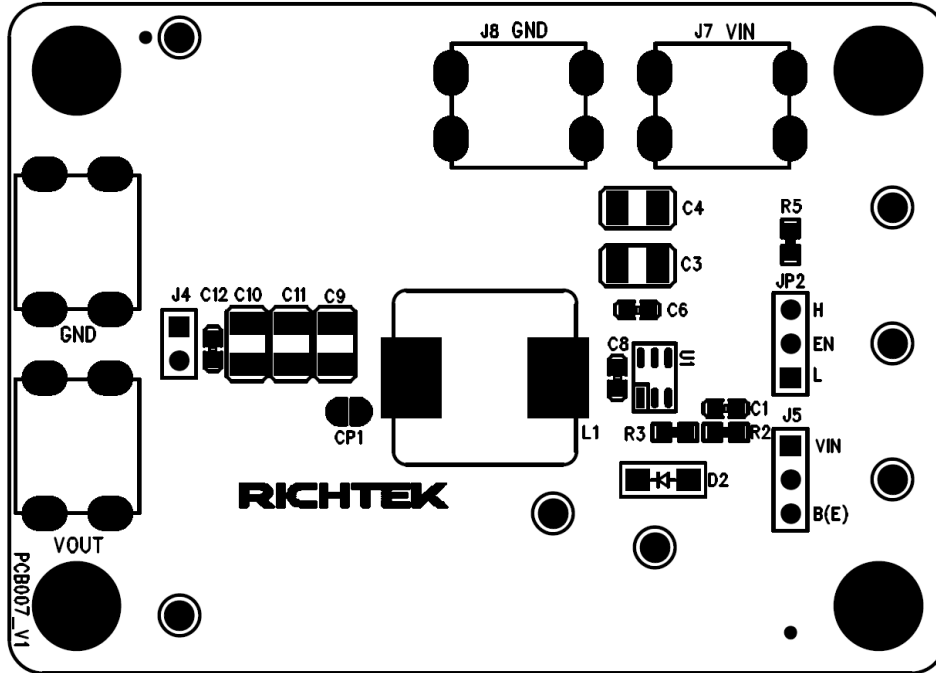

Component Placement Guide—Component Side (1st layer)

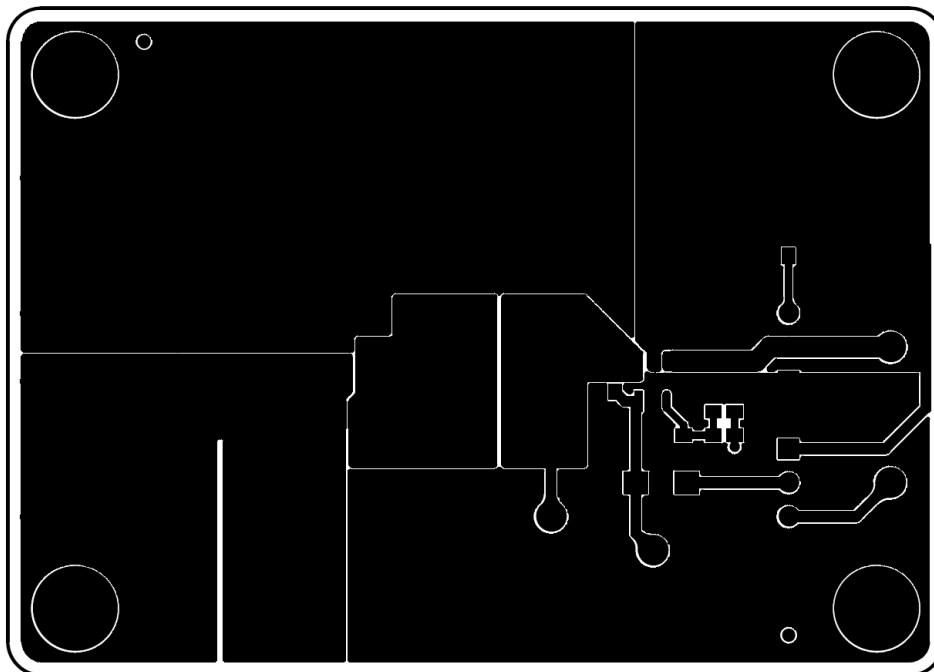

PCB Layout—Component Side (1st Layer)

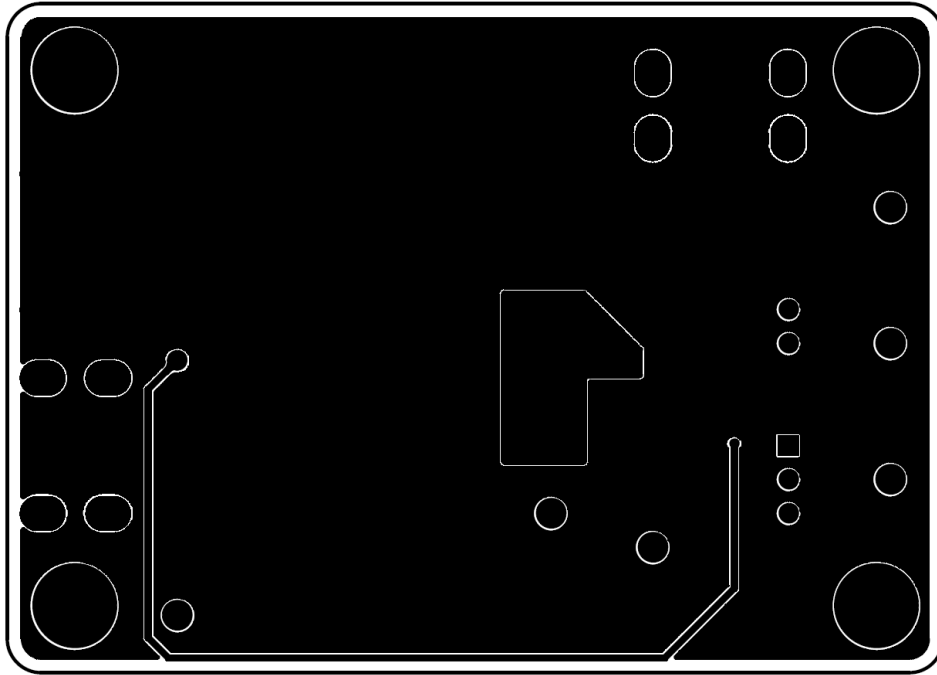

PCB Layout—Bottom Side (4th layer)

More Information

For more information, please find the related datasheet or application notes from Richtek website <http://www.richtek.com>.

Important Notice for Richtek Evaluation Board

THIS DOCUMENT IS FOR REFERENCE ONLY, NOTHING CONTAINED IN THIS DOCUMENT SHALL BE CONSTRUED AS RICHTEK'S WARRANTY, EXPRESS OR IMPLIED, UNDER CONTRACT, TORT OR STATUTORY, WITH RESPECT TO THE PRESENTATION HEREIN. IN NO EVENT SHALL RICHTEK BE LIABLE TO BUYER OR USER FOR ANY AND ALL DAMAGES INCLUDING WITHOUT LIMITATION TO DIRECT, INDIRECT, SPECIAL, PUNITIVE OR CONSEQUENTIAL DAMAGES.

单击下面可查看定价，库存，交付和生命周期等信息

[>>Richtek\(台湾立锜\)](#)