

Purpose

The RT8297B is a high-efficiency current mode synchronous step-down regulator that can deliver up to 1.5A output current from a wide input voltage range of 4V to 17V. This document explains the function and use of the RT8297B evaluation board (EVB) and provides information to enable operation and modification of the evaluation board and circuit to suit individual requirements.

Table of Contents

<i>Purpose</i>	1
<i>Introduction</i>	2
<i>General Product Information</i>	2
<i>Key Performance Summary Table</i>	3
<i>Bench Test Setup Conditions</i>	4
<i>Headers Description and Placement</i>	4
<i>Test Points</i>	4
<i>Power-up & Measurement Procedure</i>	5
<i>Output Voltage Setting</i>	5
<i>Schematic, Bill of Materials and Board Layout</i>	6
<i>EVB Schematic Diagram</i>	6
<i>Bill of Materials</i>	7
<i>EVB Layout</i>	8
<i>More Information</i>	12
<i>Important Notice for Richtek Evaluation Board</i>	12

Introduction

General Product Information

General Description

The RT8297B is a high efficiency, monolithic synchronous step-down DC/DC converter that operates at 800kHz and delivers up to 1.5A output current from a 4V to 17V input supply. The RT8297B's current mode architecture allows the transient response to be optimized. Cycle-by-cycle current limit provides protection against shorted outputs and soft-start eliminates input current surge during start-up. Fault conditions also include output under voltage protection, output over voltage protection, and thermal shutdown. The low current (<5 μ A) shutdown mode provides output disconnect, enabling easy power management in battery-powered systems. The RT8297B is available in a WDFN-8L 2x2 package.

Feature

- 4V to 17V Input Voltage Range
- 1.5A Output Current
- Internal N-MOSFETs
- Current Mode Control
- Fixed Frequency Operation : 800kHz
- Output Adjustable from 0.8V to 12V
- Up to 95% Efficiency
- Internal Compensation
- Stable with Low ESR Ceramic Output Capacitors
- Cycle-by-Cycle Over Current Protection
- Input Under Voltage Lockout
- Output Under Voltage Protection
- Output Over Voltage Protection
- Power Good Indicator
- Thermal Shutdown Protection

Key Performance Summary Table

Key features	Evaluation board number: PCB005_V1
Default Input Voltage	12V
Max Output Current	1.5A
Default Output Voltage	3.3V
Default Marking & Package Type	RT8297BZQW (WDFN-8L 2x2)
Operation Frequency	Steady 800kHz at all load currents
Other Key Features	4V to 17V Input Voltage Range Power Good Indicator Tiny WDFN-8L 2x2 package
Protection	Over Current Protection Hiccup Mode Output Under-Voltage & Over-Voltage Protection Thermal Shutdown

Bench Test Setup Conditions

Headers Description and Placement

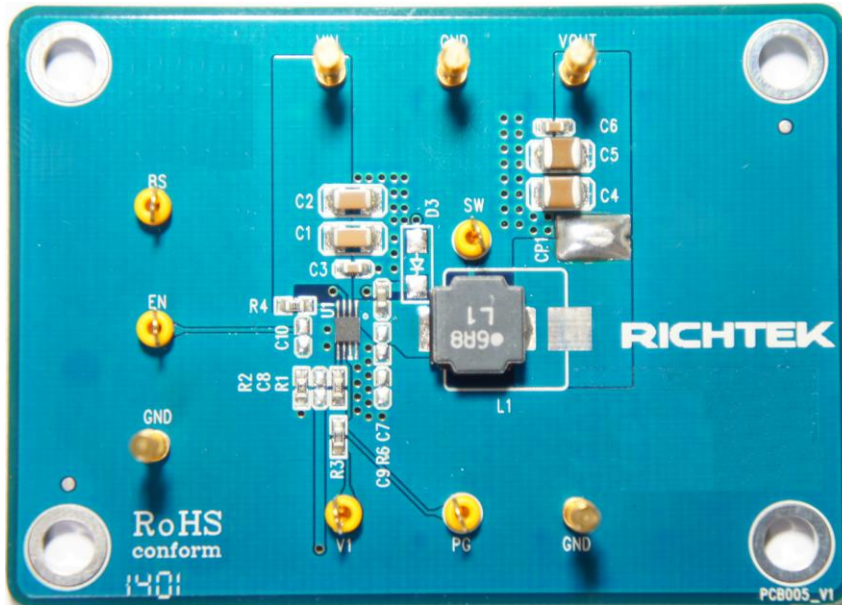

Please carefully inspect the EVB IC and external components, comparing them to the following Bill of Materials, to ensure that all components are installed and undamaged. If any components are missing or damaged during transportation, please contact the distributor or send e-mail to evb_service@richtek.com.

Test Points

The EVB is provided with the test points and pin names listed in the table below.

Test point/ Pin name	Signal	Comment (expected waveforms or voltage levels on test points)
VIN	Input voltage	Input voltage range= 4V to 17V
VOUT	Output voltage	Default output voltage = 3.3V Output voltage range= 0.8V to 12V (see " Output Voltage Setting" section for changing output voltage level)
SW	Switching node test point	SW waveform
EN	Enable test point	Enable signal. EN is automatically pulled high (by R4) to enable operation. Connect EN low to disable operation.
BS	Boot strap supply test point	Floating supply voltage for the high-side N-MOSFET switch
PG	Power Good test point	Power Good Indicator
V1	External Voltage for PG	External voltage terminal for PG pull-up voltage.
GND	Ground	Ground

Power-up & Measurement Procedure

1. Apply a 12V nominal input power supply ($4V < V_{IN} < 17V$) to the VIN and GND terminals.
2. The EN voltage is pulled to logic high by R4 (100k Ω to VIN) to enable operation. Drive EN high (>2.5V) to enable operation or low (<0.4V) to disable operation.
3. Verify the output voltage (approximately 3.3V) between VOUT and GND.
4. Connect an external load up to 1.5A to the VOUT and GND terminals and verify the output voltage and current.

Output Voltage Setting

Set the output voltage with the resistive divider (R1, R2) between VOUT and GND with the midpoint connected to FB. The output is set by the following formula:

$$V_{OUT} = 0.8 \times \left(1 + \frac{R1}{R2}\right) \quad V_{OUT} = 0.8 \times \left(1 + \frac{R1}{R2}\right)$$

The installed V_{OUT} capacitors (C4, C5) are 22 μ F, 16V X5R ceramic types. Do not exceed their operating voltage range and consider their voltage coefficient (capacitance vs. bias voltage) and ensure that the capacitance is sufficient to maintain stability and provide sufficient transient response for your application. This can be verified by checking the output transient response as described in the RT8297 IC datasheet.

Schematic, Bill of Materials and Board Layout

EVB Schematic Diagram

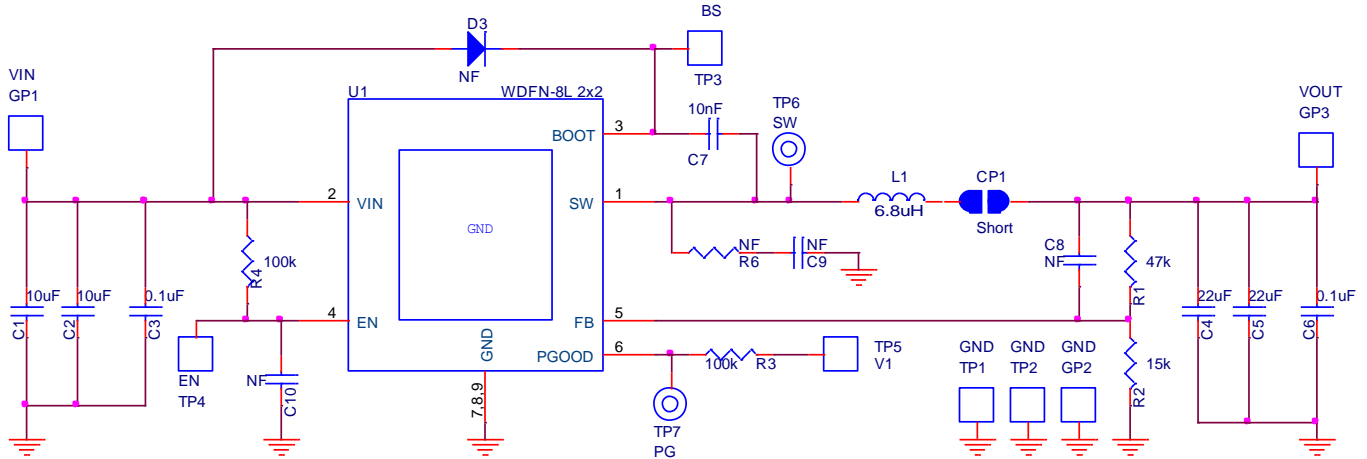

C1, C2: 10 μ F/50V/X5R, 1206, TDK C3216X5R1H106K

C4, C5: 22 μ F/16V/X5R, 1210, Murata GRM32ER61C226K

L1: 6.8 μ H TAIYO YUDEN NR8040T6R8N, DCR=25m Ω

Bill of Materials

Reference	Qty	Part number	Description	Package	Manufacture
U1	1	RT8297BZQW	DC-DC Converter	WDFN-8L 2x2	Richtek
C1, C2	2	C3216X5R1H106K160AB	10 μ F/ \pm 10%/50V/X5R Ceramic Capacitor	1206	TDK
C4, C5	2	GRM32ER61C226KE20#	22 μ F/ \pm 10%/16V/X5R Ceramic Capacitor	1210	Murata
C7	1	GRM32MR71H103KA01#	10nF/ \pm 10%/50V/X7R Ceramic Capacitor	0603	Murata
C3, C6	2	C1608X7R1H104K080AA	0.1 μ F/ \pm 10%/50V/X7R Ceramic Capacitor	0603	TDK
C8, C9, C10	0		Not Installed	0603	
L1	1	NR8040T6R8N	6.8uH/3.7A/ \pm 30%, DCR=25m Ω , Inductor	8mmx8mmx4mm	TAIYO YUDEN
R1	1		47k Ω / \pm 1%, Resistor	0603	
R2	1		15k Ω / \pm 1%, Resistor	0603	
R3, R4	1		100k Ω / \pm 1%, Resistor	0603	
CP1	1		Short		
D3, R6	0		Not Installed		
TP	6		Test Pin		
GP	4		Golden Pin		

EVB Layout

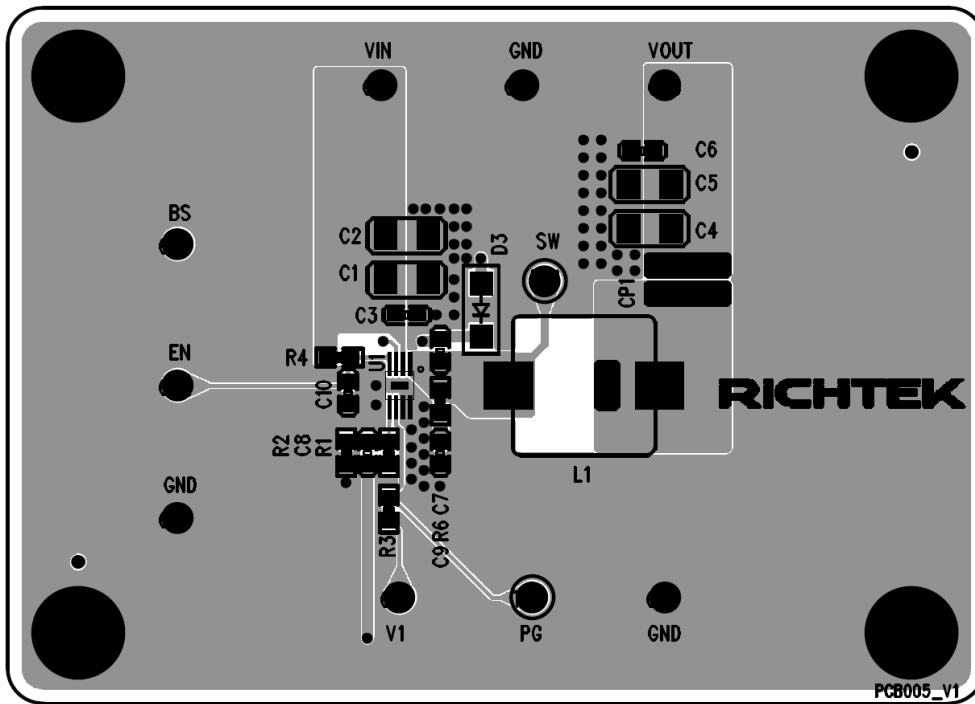

Top View (1st layer)

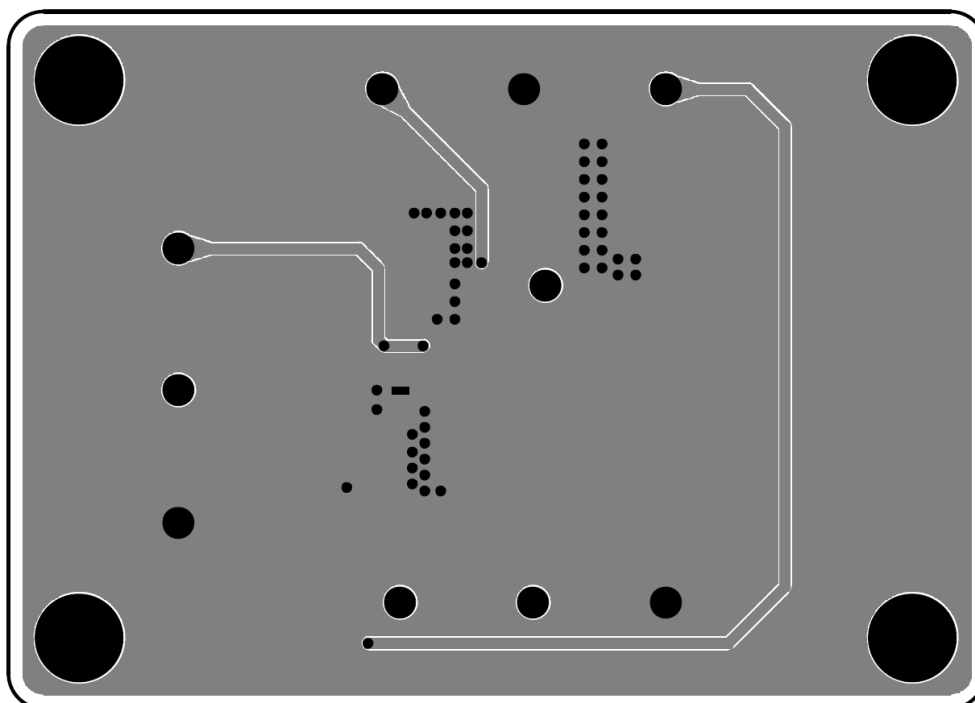

Bottom View (4th Layer)

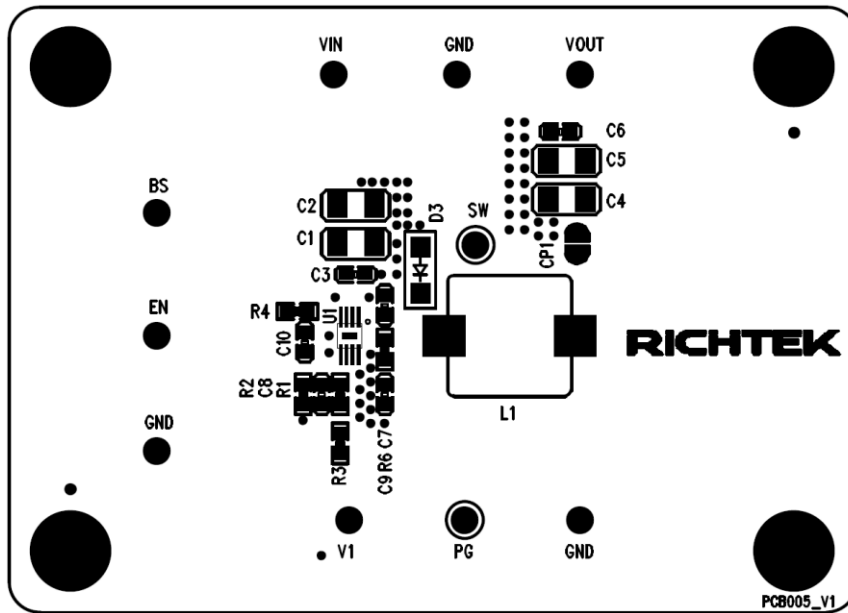

Component Placement Guide—Component Side (1st layer)

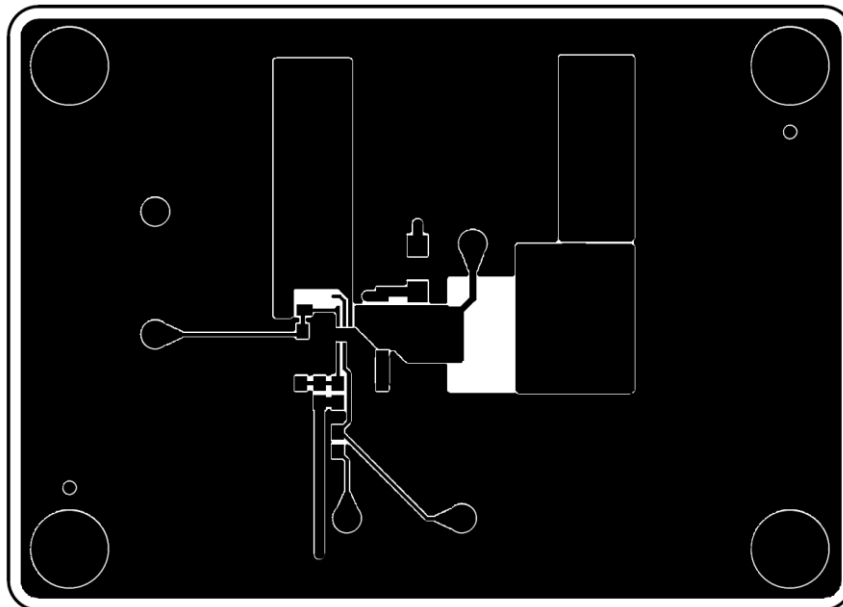

PCB Layout—Component Side (1st Layer)

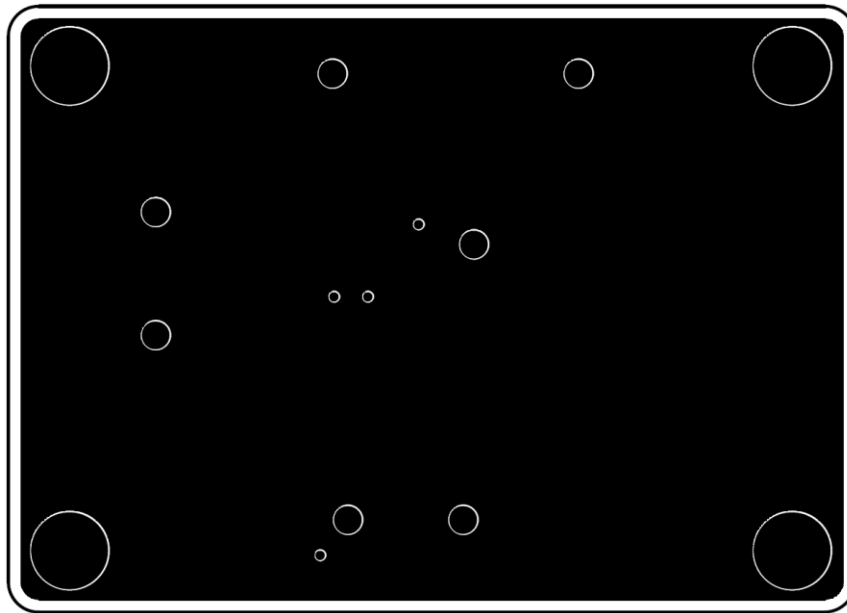

PCB Layout—Inner Side (2nd layer)

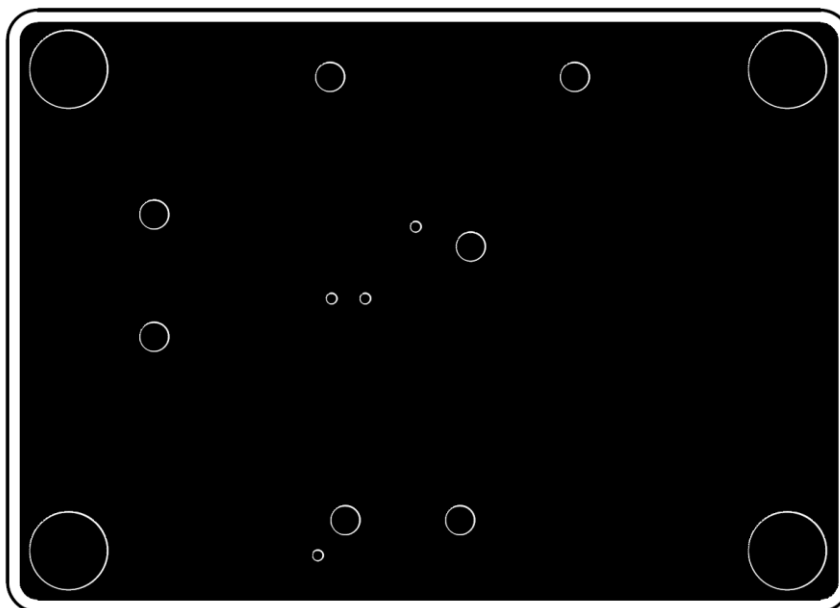

PCB Layout—Inner Side (3rd layer)

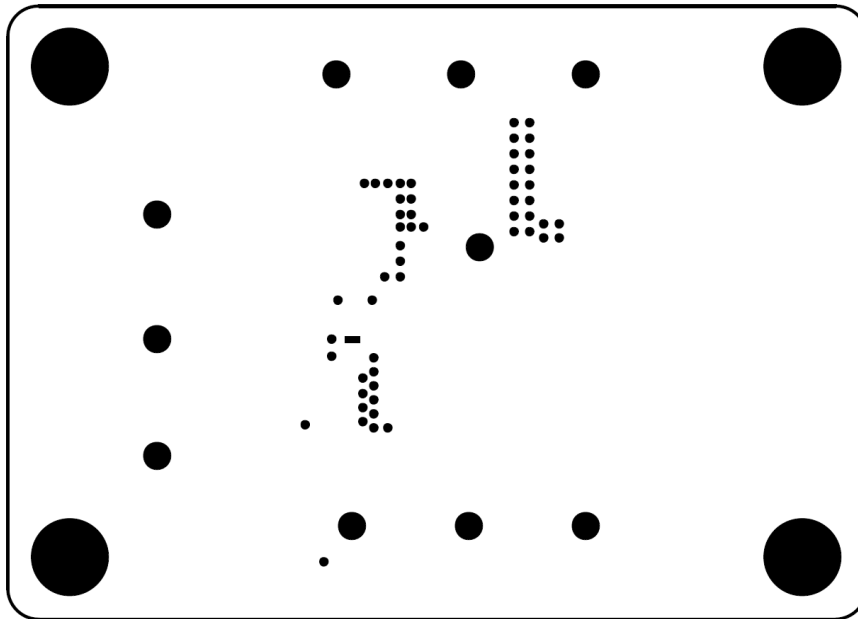

Component Placement Guide—Bottom Side (4th Layer)

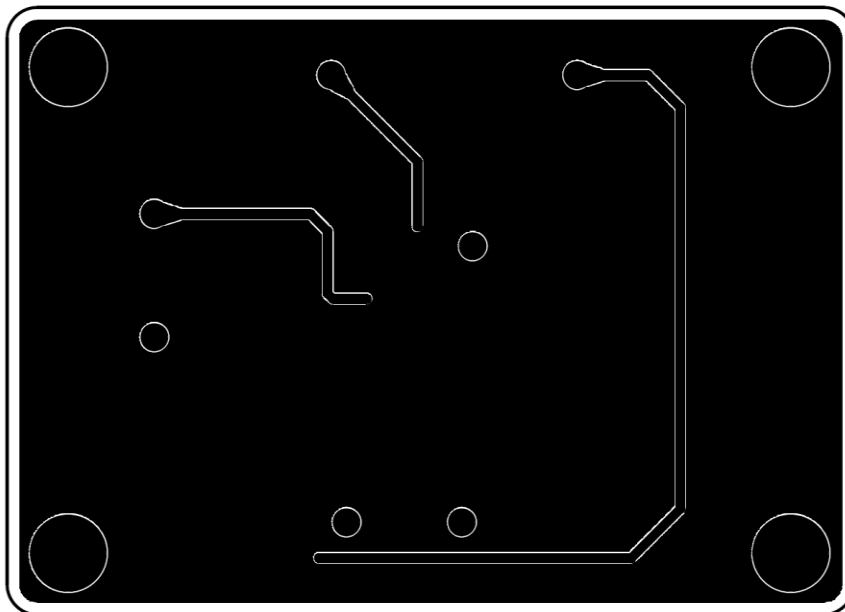

PCB Layout—Bottom Side (4th Layer)

More Information

For more information, please find the related datasheet or application notes from Richtek website <http://www.richtek.com>.

Important Notice for Richtek Evaluation Board

THIS DOCUMENT IS FOR REFERENCE ONLY, NOTHING CONTAINED IN THIS DOCUMENT SHALL BE CONSTRUED AS RICHTEK'S WARRANTY, EXPRESS OR IMPLIED, UNDER CONTRACT, TORT OR STATUTORY, WITH RESPECT TO THE PRESENTATION HEREIN. IN NO EVENT SHALL RICHTEK BE LIABLE TO BUYER OR USER FOR ANY AND ALL DAMAGES INCLUDING WITHOUT LIMITATION TO DIRECT, INDIRECT, SPECIAL, PUNITIVE OR CONSEQUENTIAL DAMAGES.

单击下面可查看定价，库存，交付和生命周期等信息

[>>Richtek\(台湾立锜\)](#)