

Synchronous Step-Down Converter's Evaluation Board for RT7238 Integrated Chip

Purpose

The RT7238B/C/D is an advance integrative chip, which includes a LDO regulator and a synchronous Buck converter. This document explains the function and use of the RT7238 evaluation board (EVB) and provides information to enable operation and modification of the evaluation board and circuit to suit individual requirements.

Table of Contents

Purpose	1
Introduction.....	2
Application.....	2
Key Performance Summary Table.....	2
Bench Test Setup Conditions	3
Schematic, Bill of Materials & Board Layout	5
More Information.....	9
Important Notice for Richtek Evaluation Board	9

Introduction

General Product Description

The RT7238B/C/D is an advanced constant on-time (ACOT™) mode synchronous step-down converter. The main control loop of RT7238B/C/D using an advanced constant on-time (ACOT™) mode control which provides a very fast transient response. The RT7238B/C/D operates from 8V to 23V input voltage. For the RT7238D, the output voltage can be adjusted between 0.6V to 5V. The RT7238B/C/D is available in the UQFN-10L 3x3 (FC) package.

Product Features

- Advanced Constant On-Time (ACOT) Control
- 8V to 23V (RT7238B/C/D) Input Voltage Range @ 8A Output Current
- ACOT™ Mode Performs Fast Transient Response
- ACOT™ Architecture to Enable all MLCC Output Capacitor Usage
- Fixed 500kHz Switching Frequency
- High Efficient Internal Power MOSFET Switch
 - ▶ 27mΩ (High-Side) and 10mΩ (Low-Side)
- Adjustable Output Voltage from 0.9V to 5V (RT7238D)
- Fixed 3.3V (RT7238B/D) or 5V (RT7238C) LDO Output Supplies 70mA
- Pre-biased Soft-Start Cycle-by-Cycle Over-Current Protection
- Input Under-Voltage Lockout
- Thermal Shutdown
- Output Over/Under-Voltage Protection

Application

- Industrial and Commercial Low Power Systems
- Computer Peripherals
- LCD Monitors and TVs
- Green Electronics/Appliances
- Point of Load Regulation for High-Performance DSPs, FPGAs, and ASICs

Key Performance Summary Table

Key Features	Evaluation Board Number : PCB029_V1
Default Input Voltage	8V to 23V
Max Output Current	8A
Default Output Voltage	3.3V (RT7238B) 5.1V (RT7238C) 1.05V (RT7238D)
Default Marking & Package Type	RT7238B/C/D, UQFN-10L 3x3 (FC)
Operation Frequency	500kHz

Bench Test Setup Conditions

Headers Description and Placement

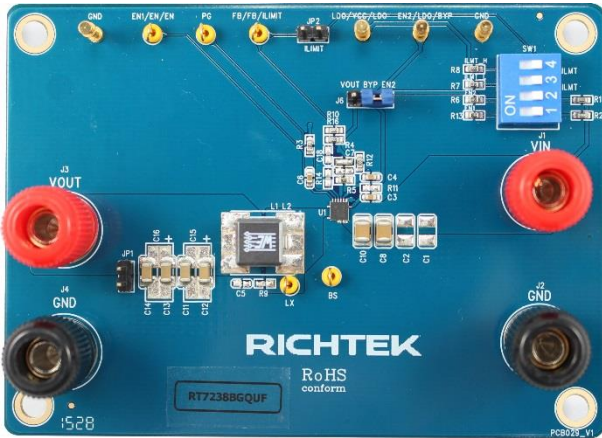

RT7238B Top View

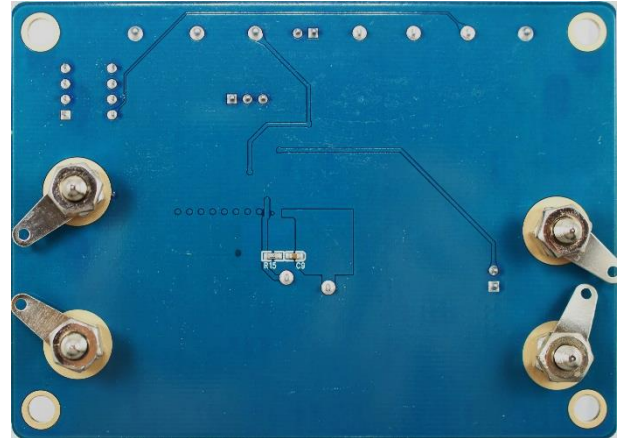

RT7238B Bottom View

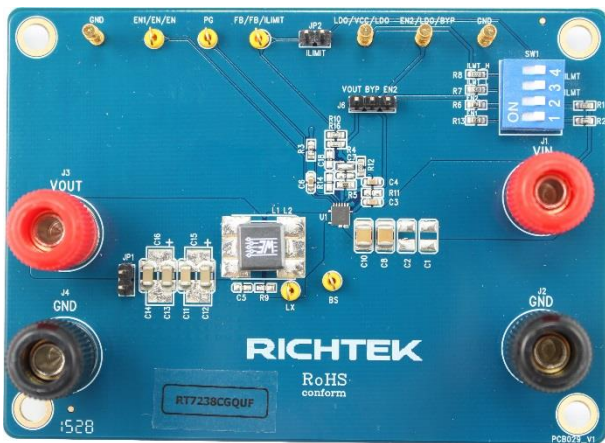

RT7238C Top View

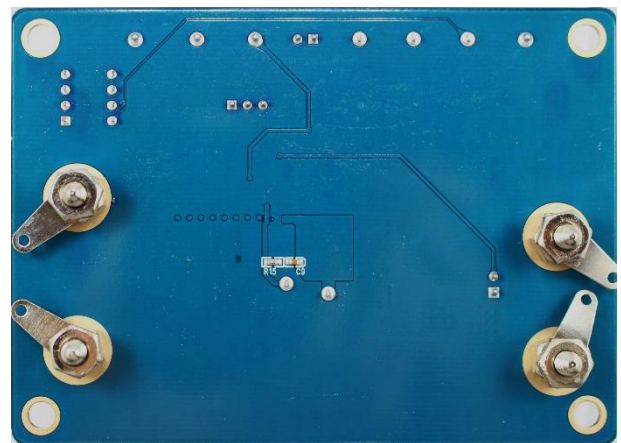

RT7238C Bottom View



RT7238D Top View

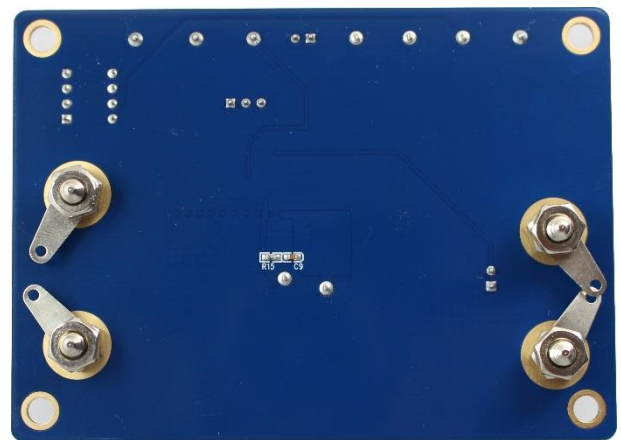

RT7238D Bottom View

Please carefully inspect the EVB IC and external components, comparing them to the following Bill of Materials, to ensure that all components are installed and undamaged. If any components are missing or damaged during transportation, please contact the distributor or send e-mail to evb_service@richtek.com

Test Points, Jumpers and Switches

The EVB is provided with the test points, jumpers, switches and individual names listed in the table below.

Test point/ name	Signal	Description (expected waveforms or voltage levels on test points)
VIN	Input voltage	Input voltage range 8V to 23V
VOUT	Output voltage	Output voltage 3.35V(RT7238B), 5.1V(RT7238C), adjustable(RT7238D)
LX	LX voltage	Switch Node
BS	BOOT voltage	Bootstrap supply for high-side gate driver.
EN2/LDO/BYP	EN2/LDO/BYP voltage	Enable Control Input of the IC and Internal LDO for RT7238B Internal 5V LDO Output for RT7238C Bypass Input for the Internal LDO for RT7238D
LDO/VCC/LDO	LDO/VCC/LDO voltage	Internal 3.3V LDO Output for RT7238B/D No Internal Connection for RT7238C
FB/FB/ILMIT	LDO/VCC/LDO voltage	Current Limit Setting for RT7238D No Internal Connection for RT7238B/C
PG	PG voltage	Power Good Indicator.This pin connect to LDO output through R3.
EN1/EN/EN	EN1/EN/EN voltage	Enable Control Input of the DC/DC Regulator.
GND	Ground	Ground

Jumpers/ name	Signal	Description (expected waveforms or voltage levels on test points)
JP1	Output voltage	Output voltage 3.35V(RT7238B), 5.1V(RT7238C), adjustable(RT7238D)
JP2	Current Limit Setting voltage	This jumper only provides current limit setting function for RT7238D Please remove R16, short R10 R14 C18 and short this jumper when setting the current limit.
JP3	VOUT/BYP/EN2 voltage	This jumper provides different settings for RT7238B/D. When this EVB applis for RT7238D, this jumper can provide BYP pin bypass to buck output voltage function as BYP shorting to VOUT.When this EVB applis for RT7238B, please short the BYP to EN2.

Switches/ name	Signal	Description (expected waveforms or voltage levels on test points)
SW1	EN1 voltage EN2 voltage ILMT_L voltage ILMT_H voltage	This switch provide EN1, EN2, and current limit setting functions. When this EVB applis for RT7238C/D/E, the EN1 switch is used to enable EN. When this EVB applis for RT7238D, it can set ILMIT pin to "floating" by turn off ILMT_L and ILMT_H, "0" by turn on ILMT_L and turn off ILMT_H and "1" by turn off ILMT_L and turn on ILMT_H. In order to avoid function fail. Please don't turn on ILMT_L and ILMT_H simultaneously.

Power-up & Operating Guideline

1. RT7238B starts work by providing VIN voltage then turn on EN1 and EN2 switches. In the RT7238B application, the BYP and VOUT of jumper JP3 must always short together and resistor R4 must always be shorted.
2. RT7238C starts work by providing VIN voltage then turn on EN1 switches. In the RT7238C application, the resistor R4 must always be shorted.
3. RT7238D starts work by providing VIN voltage then turn on EN1 switches. In the RT7238D application, the output voltage can be setted by individual resistor R4 and R5. Moreover, the current limit threshold can be chosen through ILMIT_L and ILMIT_H switches after the jumper J2 , resistor R14, R10 and capacitor C18 are shorted.

Schematic, Bill of Materials & Board Layout

EVB Schematic Diagram

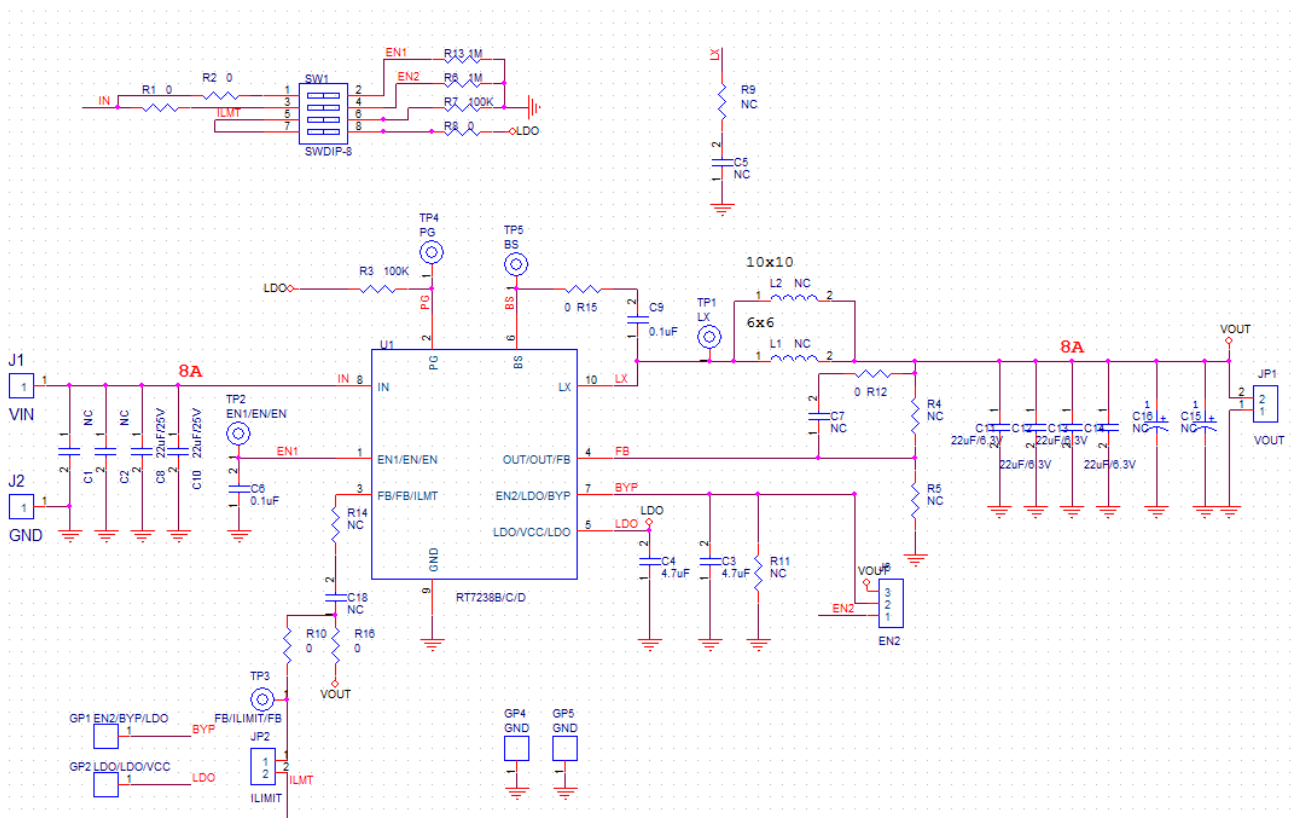

Bill of Materials

Reference	Q'ty	Part Number	Description	Package	Manufacture
C3, C4	2	C1608X5R0J475KT000N	4.7 μ F/6.3V/0603/X5R	0603	TDK
L1	1	7443340100	1 μ H for RT7238D 2.2 μ H for RT7238B/C	8 x 8 x 7.5 mm	GOTREND
C6, C9	2	C1608X7R1H104KT000N	0.1 μ F/50V/0603/X5R	0603	TDK
C8, C10	2	GRM31CR61A226KE19L	22 μ F/25V/1206/X5R	1206	muRata
C11, C12, C13, C14	4	C3225X5R1E226MT	22 μ F/25V/1210/X5R	1210	TDK
BYP/EN2/VCC	1	Gold PIN	Gold PIN	Gold PIN	Gold PIN
LDO/VCC/LDO	1	Gold PIN	Gold PIN	Gold PIN	Gold PIN
J1, J2, J3, J4	4	Connector	Connector	Connector	Connector
GND	2	Gold PIN	Gold PIN	Gold PIN	Gold PIN
JP1 ,JP2, J6	3	Jumper	Jumper	Jumper	Jumper
R1, R2, R8, R10, R12, R15, R16	7	Shorted	Shorted	Shorted	Shorted
R3, R7	2	0603 100K 1%	100k Ω /0603/1%	0603	WALSIN
R6, R13	2	0603 360K 1%	1m Ω /0603/1%	0603	WALSIN
R4	1	0603 15K0 1%	Shorted for RT7238B/C 15k Ω /0603/1% for RT7238D (VOUT 1.05V)	0603	WALSIN
R5	1	0603 20K0 1%	20k Ω /0603/1%	0603	WALSIN
SW1	1	SWITCHES	SWITCHES	SWITCHES	SWITCHES
EN1/EN/EN, PG, FB/FB/ILMIT, BS, LX	5	Test PIN	Test PIN	Test PIN	Test PIN
U1	1	RT7238B/C/D	RT7238B/C/D	UQFN-10L 3x3 (FC)	RICHTEK

PCB Layout

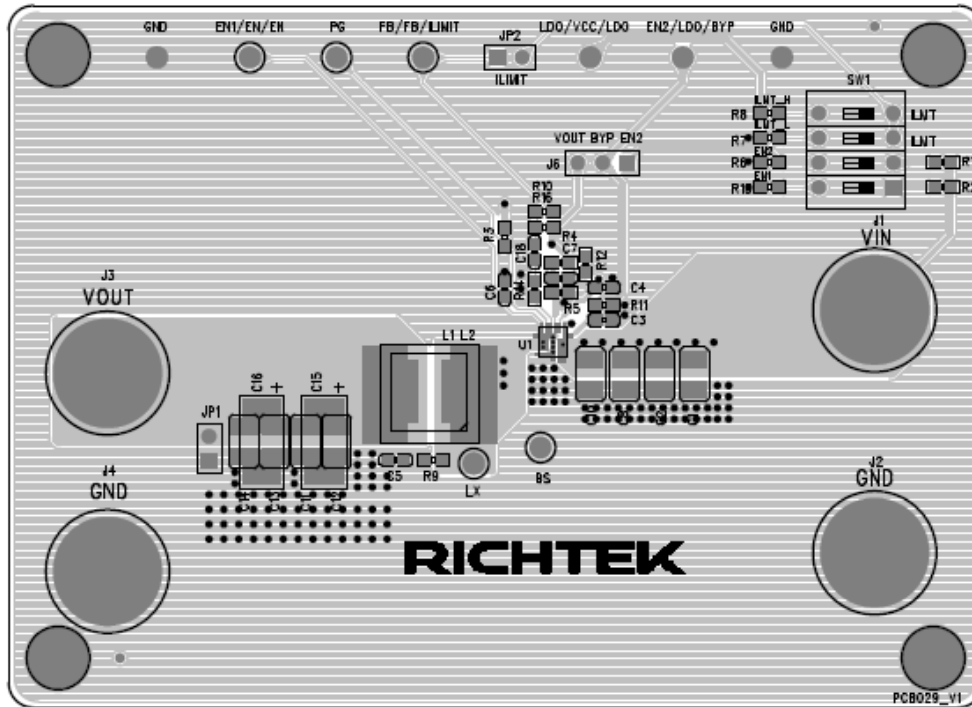

Top View (1st layer)

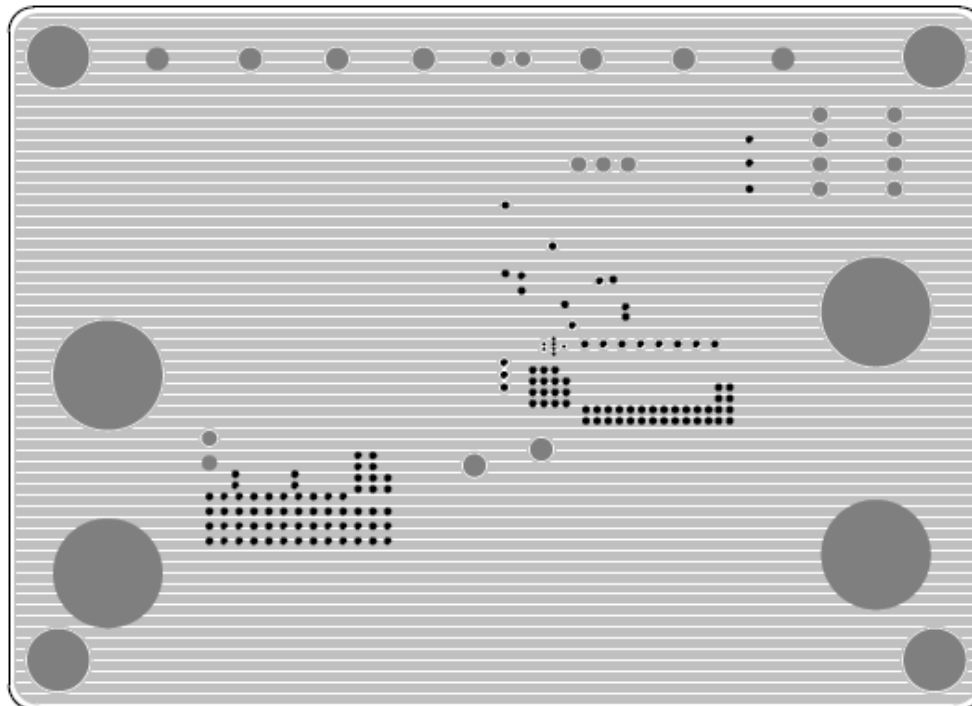

PCB Layout—Inner Side (2nd Layer)

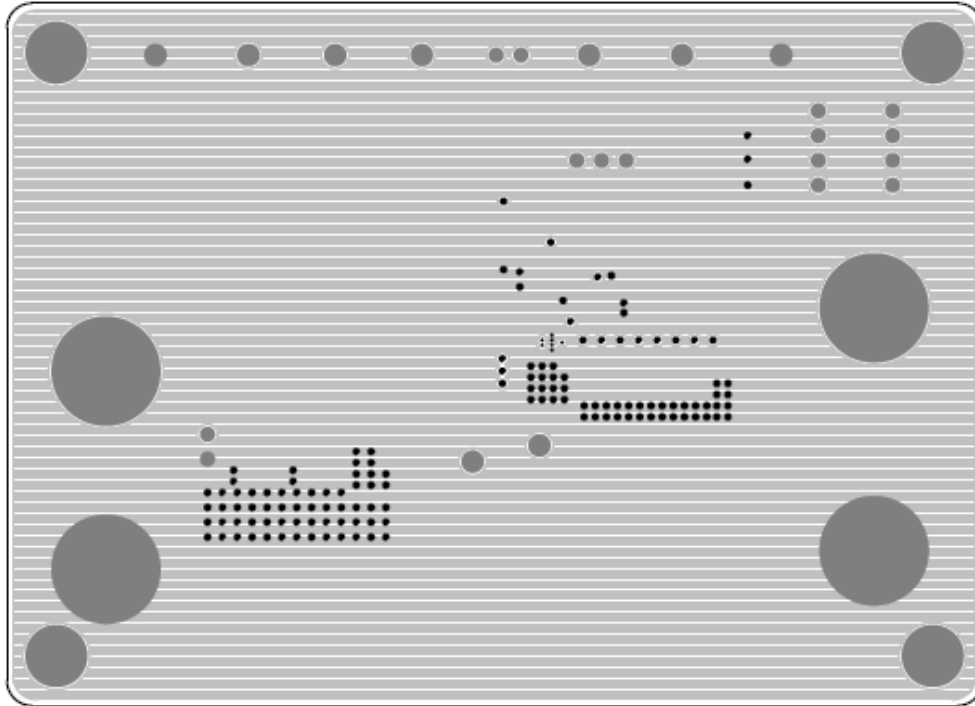

PCB Layout—Inner Side (3rd Layer)

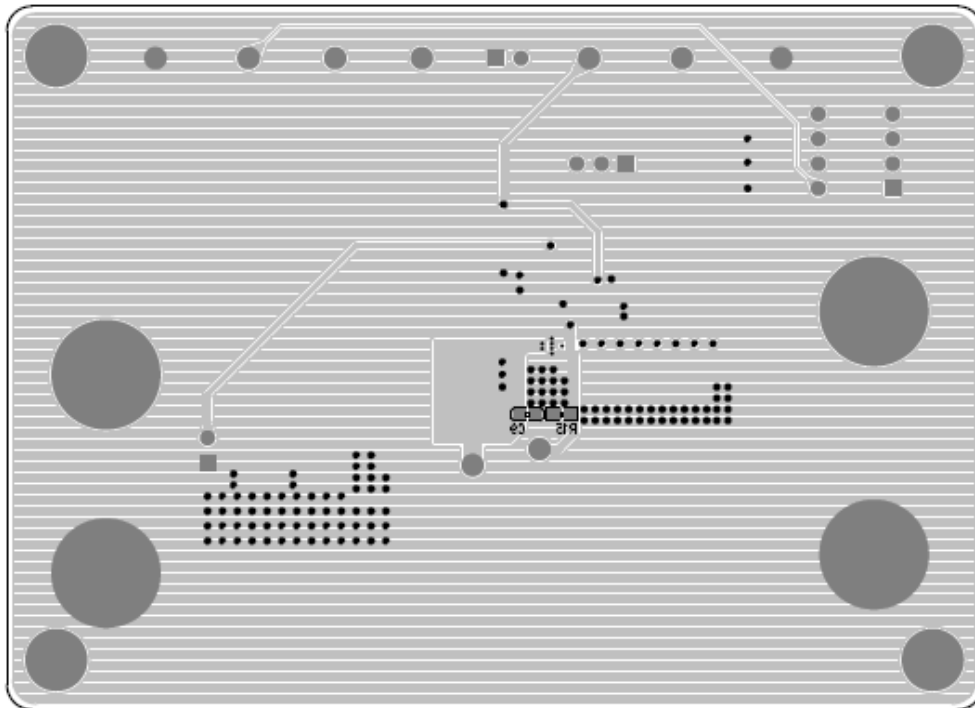

Bottom View (4th Layer)

More Information

For more information, please find the related datasheet or application notes from Richtek website <http://www.richtek.com>.

Important Notice for Richtek Evaluation Board

THIS DOCUMENT IS FOR REFERENCE ONLY, NOTHING CONTAINED IN THIS DOCUMENT SHALL BE CONSTRUED AS RICHTEK'S WARRANTY, EXPRESS OR IMPLIED, UNDER CONTRACT, TORT OR STATUTORY, WITH RESPECT TO THE PRESENTATION HEREIN. IN NO EVENT SHALL RICHTEK BE LIABLE TO BUYER OR USER FOR ANY AND ALL DAMAGES INCLUDING WITHOUT LIMITATION TO DIRECT, INDIRECT, SPECIAL, PUNITIVE OR CONSEQUENTIAL DAMAGES.

单击下面可查看定价，库存，交付和生命周期等信息

[>>Richtek\(台湾立锜\)](#)