

High Efficiency Single Synchronous Buck PWM Controller

Purpose

The RT8129A integrates a Constant-On-Time (COT) PWM controller and MOSFET driver so that the external circuit is easily designed and the components are reduced.

The controller provides the PWM signal which relies on the FB voltage comparing with internal reference voltage. The synchronous UGATE driver is turned on at the beginning of each cycle. After the internal one-shot timer expires, the UGATE driver will be turned off. The pulse width of this one-shot is determined by the controller's input voltage and the output voltage to keep the frequency fairly constant over the input voltage and output voltage range. Another one-shot sets a minimum off-time.

Table of Contents

Purpose	1
Introduction.....	2
Key Performance Summary Table	2
Bench Test Setup Conditions	3
Schematic, Bill of Materials & Board Layout	4
More Information.....	11
Important Notice for Richtek Evaluation Board	11

Introduction

General Product Information

The RT8129A is a high efficiency single phase synchronous buck controller with 5V/12V supply voltage. The RT8129A integrates a Constant-On-Time (COT) PWM controller and a MOSFET drivers with internal bootstrap diodes, which is specifically designed to improve converter efficiency at light load condition. At light load condition, it automatically operates in the diode emulation mode to reduce switching frequency and improve conversion efficiency. Other features include power good indication, enable/disable control and internal soft-start function. The RT8129A also provide protection functions including Over Voltage Protection (OVP), Under Voltage Protection (UVP), current limit and thermal shutdown.

This device uses lossless low-side MOSFET $R_{DS(ON)}$ current sense technique for current limit with adjustable threshold set by connecting a resistor between the LGATE/OCSET and GND.

With above functions, the RT8129A provides customers a cost-effective solution for high efficiency power conversion. The RT8129A is available in the WDFN-10L 3x3 package.

Product Feature

- Wide Input Voltage Range : 2.5V to 25V
- High Light Load Efficiency
- Integrated High Driving Capability N-MOSFET Gate
- Drivers and Embedded Switching Boot Diode
- Single IC Supply Voltage : 4.5V to 13.2V
- Power-Good Indicator
- Enable/Disable Control
- Internal Soft-Start
- Programmable Current Limit Threshold
- Under Voltage Protection
- Over Voltage Protection
- Thermal Shutdown

Key Performance Summary Table

Key Features	Evaluation Board Number : PCB047_V1
Input Voltage Range	2.5V to 25V
Max Output Current	Programmable
Default Output Voltage	1.5V
Default Marking & Package Type	RT8129AGQW, WDFN-10L 3x3
Operation Frequency	300kHz

Bench Test Setup Conditions

Headers Description and Placement

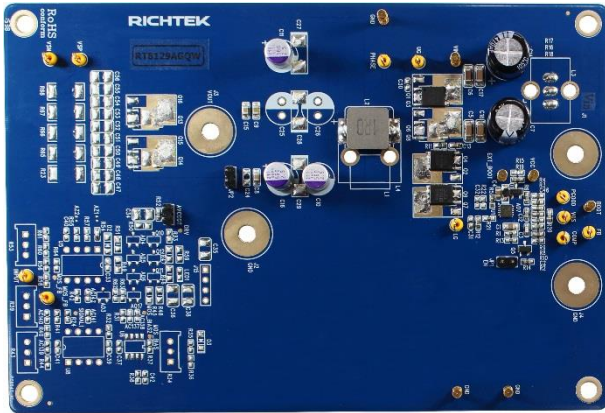

Top View

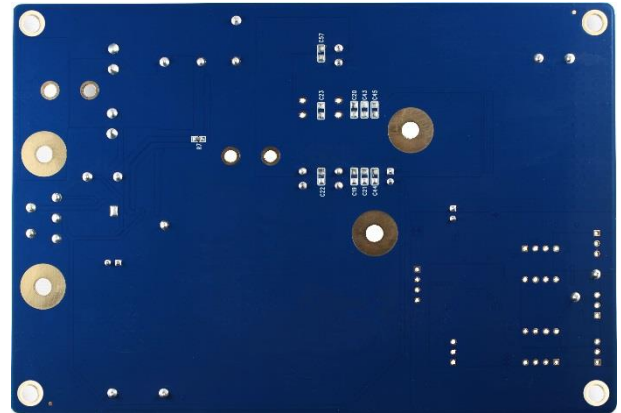

Bottom View

Please carefully inspect the EVB IC and external components, comparing them to the following Bill of Materials, to ensure that all components are installed and undamaged. If any components are missing or damaged during transportation, please contact the distributor or send e-mail to evb_service@richtek.com

Test Points

The EVB is provided with the test points and pin names listed in the table below.

Test point/ Pin name	Signal	Comment (expected waveforms or voltage levels on test points)
VIN	Input voltage	Power input. Support 2.5V to 25V Input Voltage. Must bypass with a suitable large ceramic capacitor at this pin.
COMP	Enable test point	High = Enable.
GND	Ground	Ground.
FB	Feedback voltage input	The pin is used to set the output voltage of the converter to regulate to the desired voltage via a resistive divider. Feedback reference = 0.8V.
VCC	Supply voltage input	5V bias supply input. Connect a 4.7 μ F capacitor to ground
BOOT	Bootstrap supply test point	Bootstrap supply for high-side gate driver. Connect a 0.1 μ F ceramic capacitor between the BOOT and PHASE pins.
PHASE	Switch node test point	Connect this pin to an external L-C filter.
UG	High-side switch node test point	High-side MOSFET gate driver output. Connect this pin to the Gate of high-side MOSFET.
LG	Low-side switch node test point	Low-side MOSFET gate driver output. Connect this pin to the Gate of low-side MOSFET.
PGOOD	Power good indication test point	The PGOOD voltage goes high to indicate the output voltage is in regulation.

Power-up & Measurement Procedure

1. Connect input power ($2.5V < V_{IN} < 25V$ and $4.5V < V_{CC} < 13.2V$).
2. Connect positive end and negative terminals of load to VOUT and GND test pins respectively.
3. EN pin is internal high, let JP1 open (JP1 short will turn off IC).
4. Verify the output voltage (VOUT approximately 1.5V, and FB approximately 0.8V) between VOUT to GND, and FB to GND.
5. Connect an external load up to 10A to the VOUT and GND terminals and verify the output voltage and current.

Output Voltage Setting

Set the output voltage with the resistive divider (R8, R10) between VOUT and GND with the midpoint connected to FB. The output is set by the following formula :

$$V_{OUT} = V_{FB} \times \left(1 + \frac{R8}{R10}\right)$$

Schematic, Bill of Materials & Board Layout

EVB Schematic Diagram

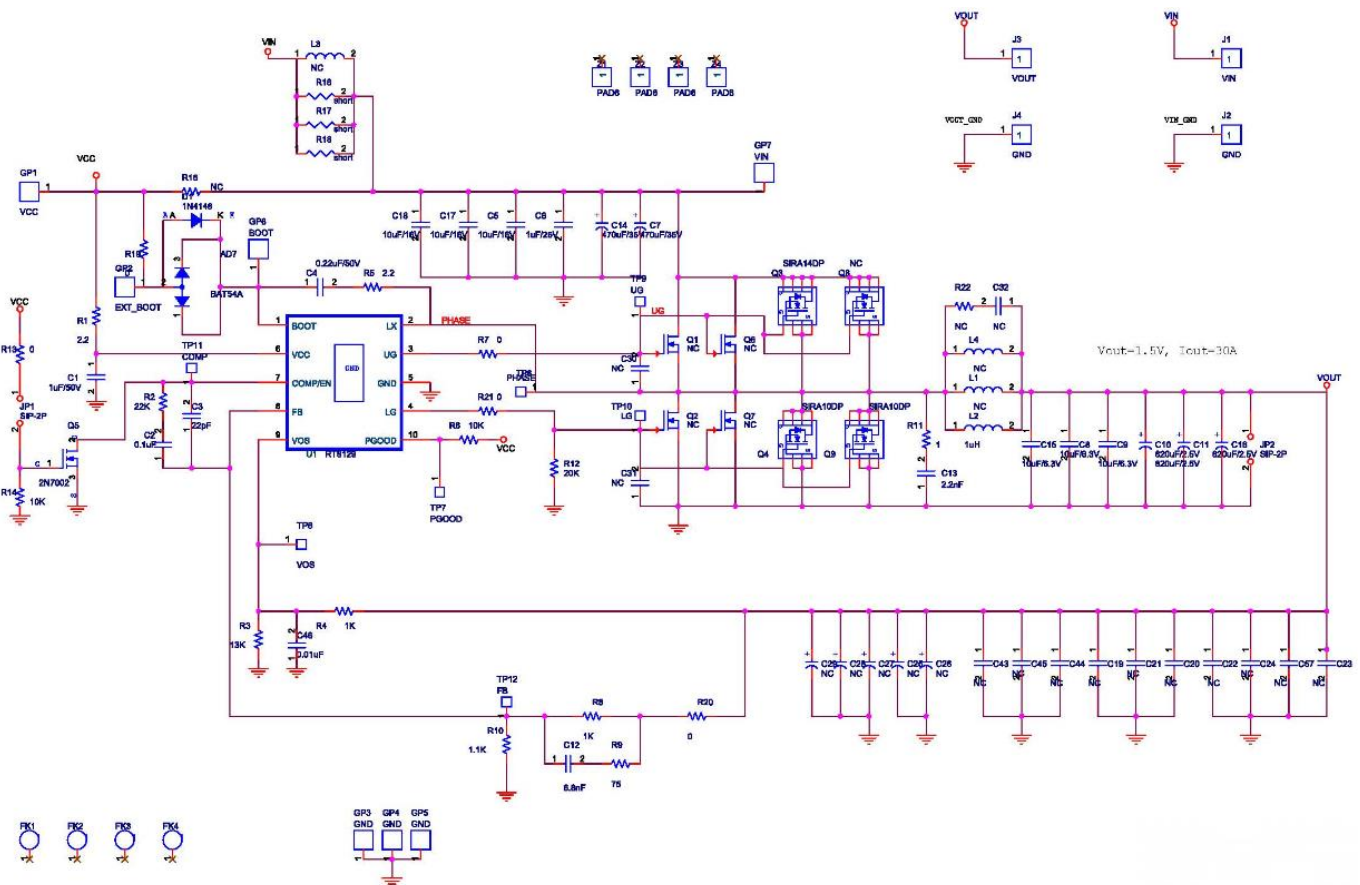

Bill of Materials

Reference	Qty	Part Number	Description	Package	Manufacture
AD7	1	BAT54A	BAT54A	SOT-23_123	
C1	1		1 μ F/50V	C-0805	
C2	1		0.1 μ F	C-0603	
C3	1		22pF	C-0603	
C4	1		0.22 μ F/50V	C-0603	
C5, C17, C18	3		10 μ F/16V	C-1206_3-3	
C6	1		1 μ F/16V	C-1206_3-3	
C7, C14	2		470 μ F/16V	EC-2P/10	
C8, C9, C15	3		10 μ F/6.3V	C-0805	
C10, C11, C16	3		820 μ F/2.5V	EC-2P_8_1	
C12	1		6.8nF	C-0603	
C13	1		2.2nF	C-0603	
C19, C20, C21, C22, C23, C24, C43, C44, C45, C57	10		NC	C-0805	
C25, C26	2		NC	EC-2P_8_1	
C27, C28, C29	3		NC	c-2512	
C30, C31, C32	3		NC	C-0603	
C46	1		0.01 μ F	C-0603	
D1	1	1N4148	1N4148	D-0805_2-3368	
FK1, FK2, FK3, FK4	4		SIP-1P-TP	FK_1	
GP1	1		VCC	SIP-1P-GP	
GP2	1		EXT_BOOT	SIP-1P-GP	
GP3, GP4, GP5	3		GND	SIP-1P-GP	
GP6	1		BOOT	SIP-1P-GP	
GP7	1		VIN	SIP-1P-GP	
JP1, JP2	2		SIP-2P	SIP-2P	
J1, J2, J3, J4	4		NC	sip-1p_p441d165	
J12, J13, J19, J20	4		NC	SIP-4P-PW-2	
L1	1		NC	L-2P/387	
L2	1		1 μ H	L-GSDRH127	
L3	1		NC	l-2p/9.82	
L4	1		NC	L-GMAR-V3R2-151311	
Q1, Q6	2	IPD09N03LA	IPD09N03LA	DPAK_GDS	
Q2, Q7	2	IPD06N03LA	IPD06N03LA	DPAK_GDS	
Q3, Q4, Q8, Q9	4		NC	Q-TDSON-8	
Q5	1		2N7002	SOT-23_123	
R1, R5	2		2.2	R-0603	
R2	1		22K	R-0603	

Reference	Qty	Part Number	Description	Package	Manufacture
R3	1		13K	R-0603	
R4, R8	2		1K	R-0603	
R6, R14	2		10K	R-0603	
R7, R13, R19, R20, R21	5		0	R-0603	
R9	1		75	R-0603	
R10	1		1.1K	R-0603	
R11	1		1	R-0603	
R12	1		20K	R-0603	
R15, R22	2		NC	R-0603	
R16, R17, R18	3		short	CP-0805C	
TP6	1		VOS	SIP-1P-TP	
TP7	1		PGOOD	SIP-1P-TP	
TP8	1		PHASE	SIP-1P-TP	
TP9	1		UG	SIP-1P-TP	
TP10	1		LG	SIP-1P-TP	
TP11	1		COMP	SIP-1P-TP	
TP12	1		FB	SIP-1P-TP	
U1	1	RT8129	RT8129	WDFN-10L 3x3	RICHTEK
Z1, Z2, Z3, Z4	4		PAD6	SIP-1P-M	

PCB Layout

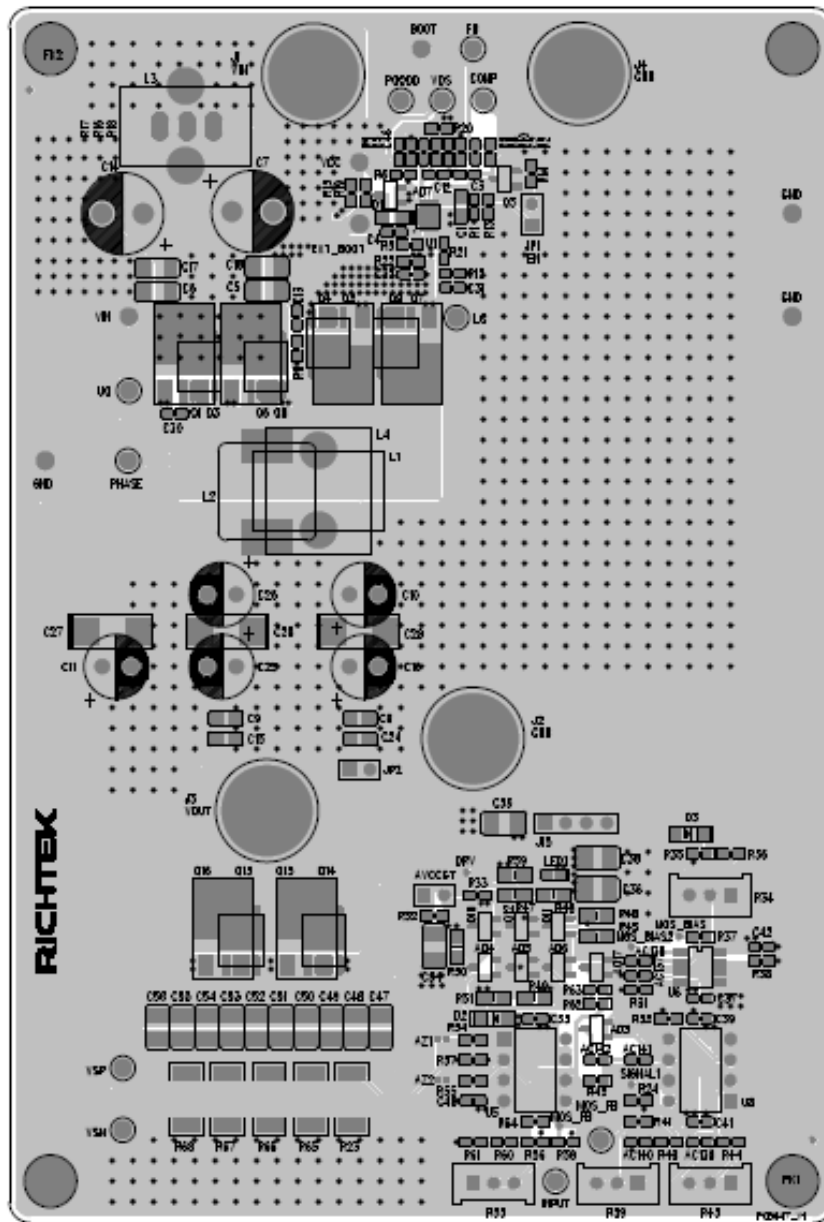

Top View (1st layer)

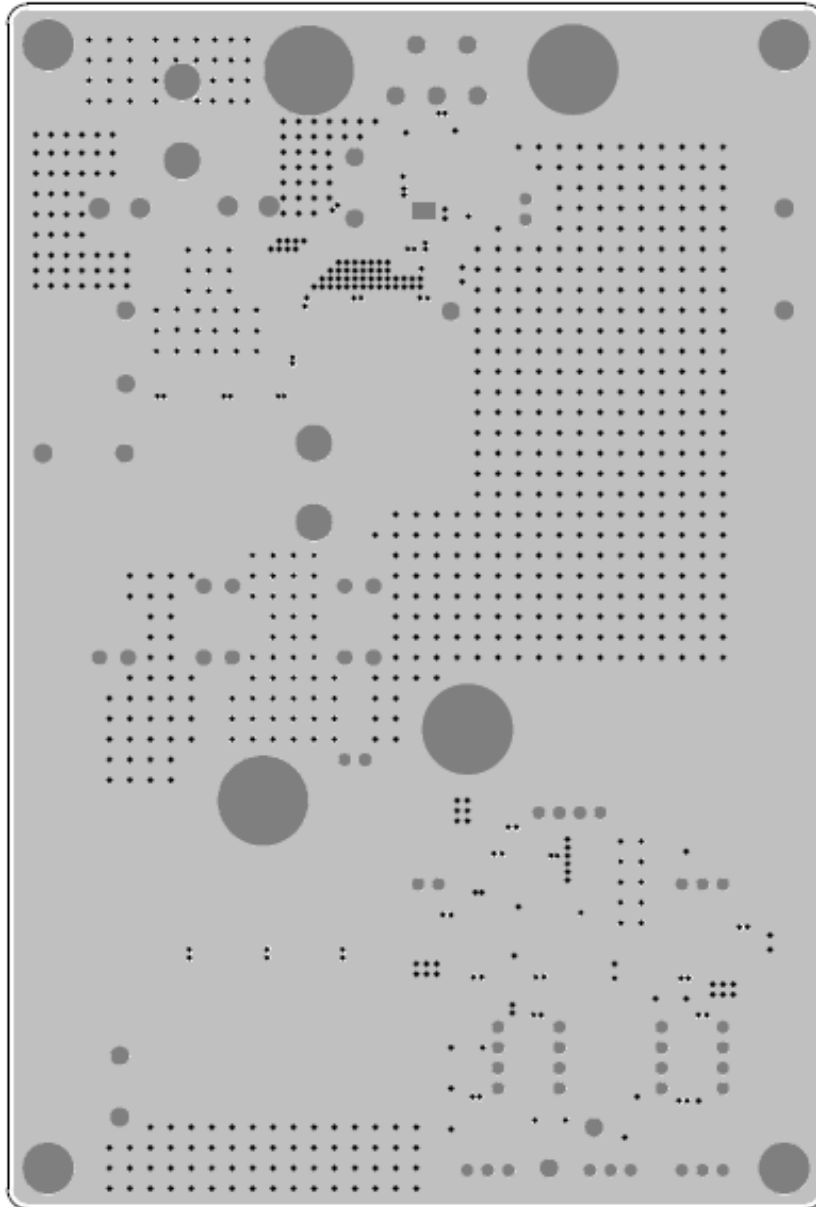

PCB Layout—Inner Side (2nd Layer)

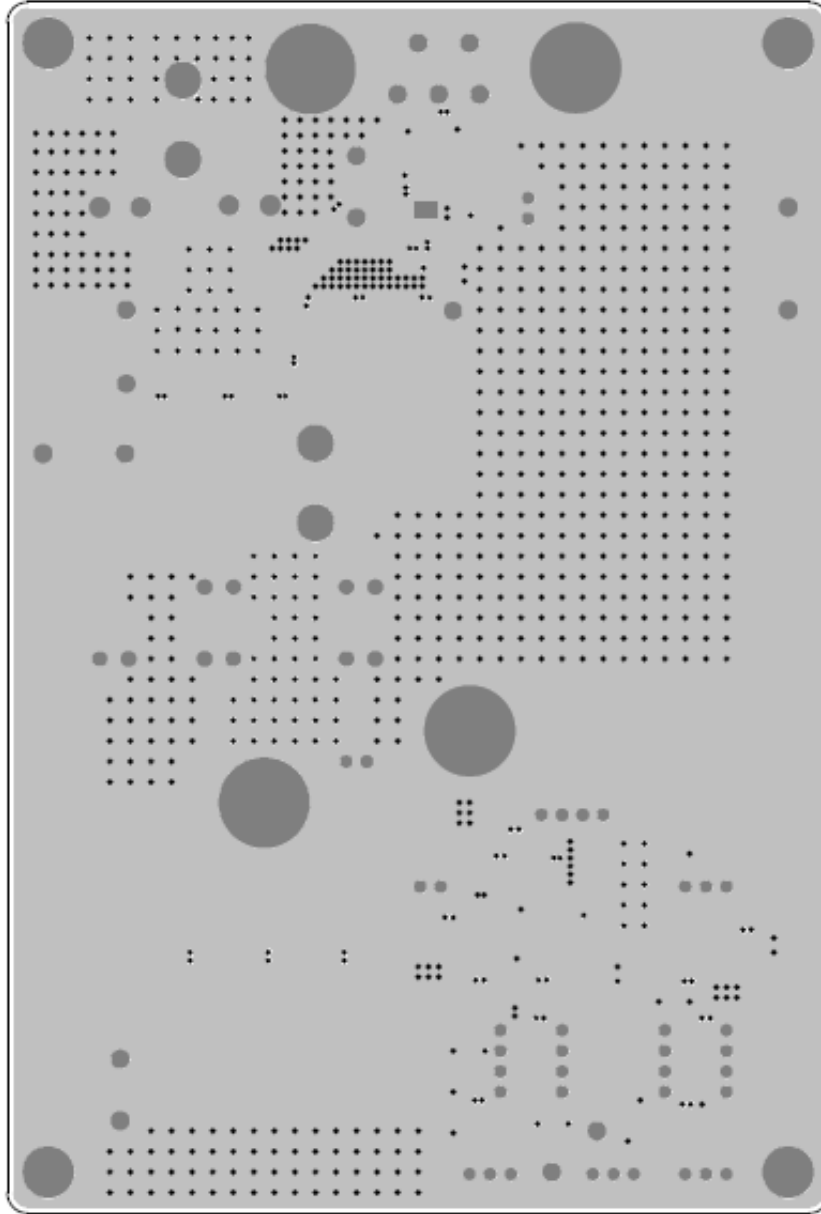

PCB Layout—Inner Side (3rd Layer)

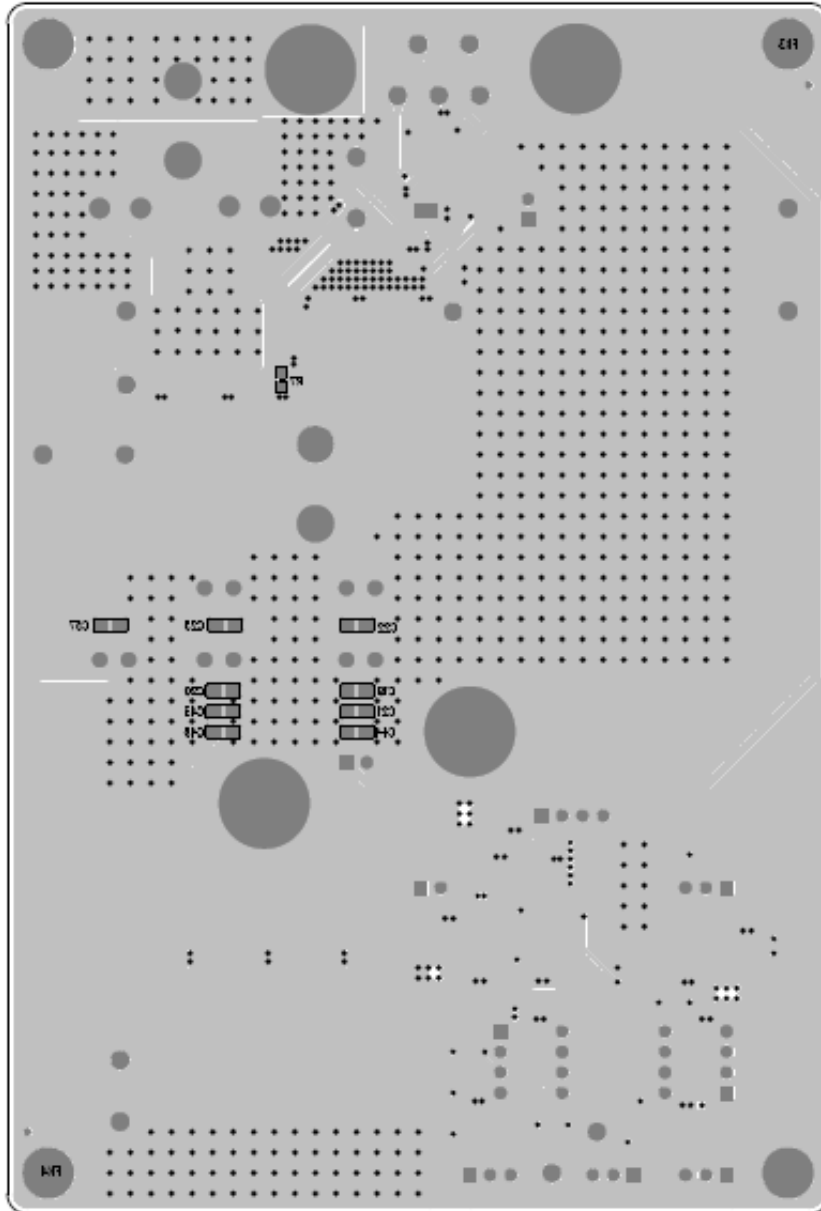

Bottom View (4th Layer)

More Information

For more information, please find the related datasheet or application notes from Richtek website <http://www.richtek.com>.

Important Notice for Richtek Evaluation Board

THIS DOCUMENT IS FOR REFERENCE ONLY, NOTHING CONTAINED IN THIS DOCUMENT SHALL BE CONSTRUED AS RICHTEK'S WARRANTY, EXPRESS OR IMPLIED, UNDER CONTRACT, TORT OR STATUTORY, WITH RESPECT TO THE PRESENTATION HEREIN. IN NO EVENT SHALL RICHTEK BE LIABLE TO BUYER OR USER FOR ANY AND ALL DAMAGES INCLUDING WITHOUT LIMITATION TO DIRECT, INDIRECT, SPECIAL, PUNITIVE OR CONSEQUENTIAL DAMAGES.

单击下面可查看定价，库存，交付和生命周期等信息

[>>Richtek\(台湾立锜\)](#)