

I²C Programmable Linear Single Cell Li-Ion Battery Charger with Auto Power-Path Management and USB/AV Switch

General Description

The RT9528 is a programmable single-cell Li-ion battery charger with I²C programmable control I/F, Auto Power-Path Management IC and USB/AV Switch. For the RT9528, there is no need to use external MOSFET. The RT9528 enters sleep mode when supplies are removed. The RT9528 optimizes the charging task by using a control algorithm including pre-charge mode, fast charge mode and constant voltage mode. The RT9528 includes termination, timer, charge current and V_{sys} settings via a serial I²C control I/F.

The RT9528 provides protections for the battery pack, charger and input circuitry such as over current, under voltage, over voltage, thermal regulation and thermal protection. Status can be monitored via the serial port for charge state and fault conditions.

The internal thermal feedback circuitry regulates the die temperature to optimize the charge rate for all ambient temperatures.

Ordering Information

RT9528	□□
	Package Type
	QW : WQFN-28L 4x4 (W-Type)
	Lead Plating System
	G : Green (Halogen Free and Pb Free)

Note :

Richtek products are :

- ▶ RoHS compliant and compatible with the current requirements of IPC/JEDEC J-STD-020.
- ▶ Suitable for use in SnPb or Pb-free soldering processes.

Marking Information

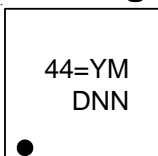

44= : Product Code
YMDNN : Date Code

Features

- 28V Maximum Rating for AC Adapter
- Auto Power Path Management (APPM)
- High-Speed USB Operation
- USB/Audio/Video Switches
- Negative Rail Audio Signal Path
- I²C controlled Interface
- Integrated 3.3V LDO for TS Circuitry
- Integrated Power MOSFETs
- Interrupt Status Indicator
- Power Good and Charge Status Indicators
- Under/Over Voltage Protection
- Thermal Feedback Optimizing Charge Rate
- 28-Lead WQFN Package
- RoHS Compliant and Halogen Free

Applications

- Digital Cameras
- PDAs and Smart Phones
- Portable Instruments

Pin Configurations

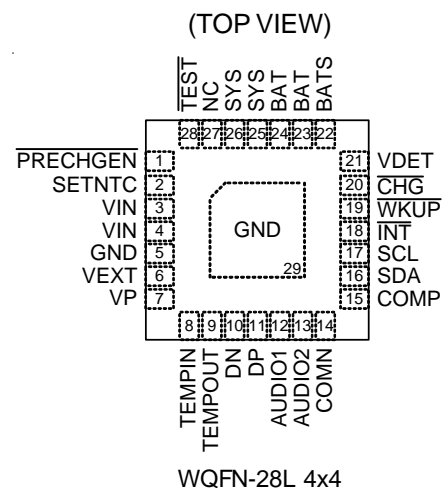

Typical Application Circuit

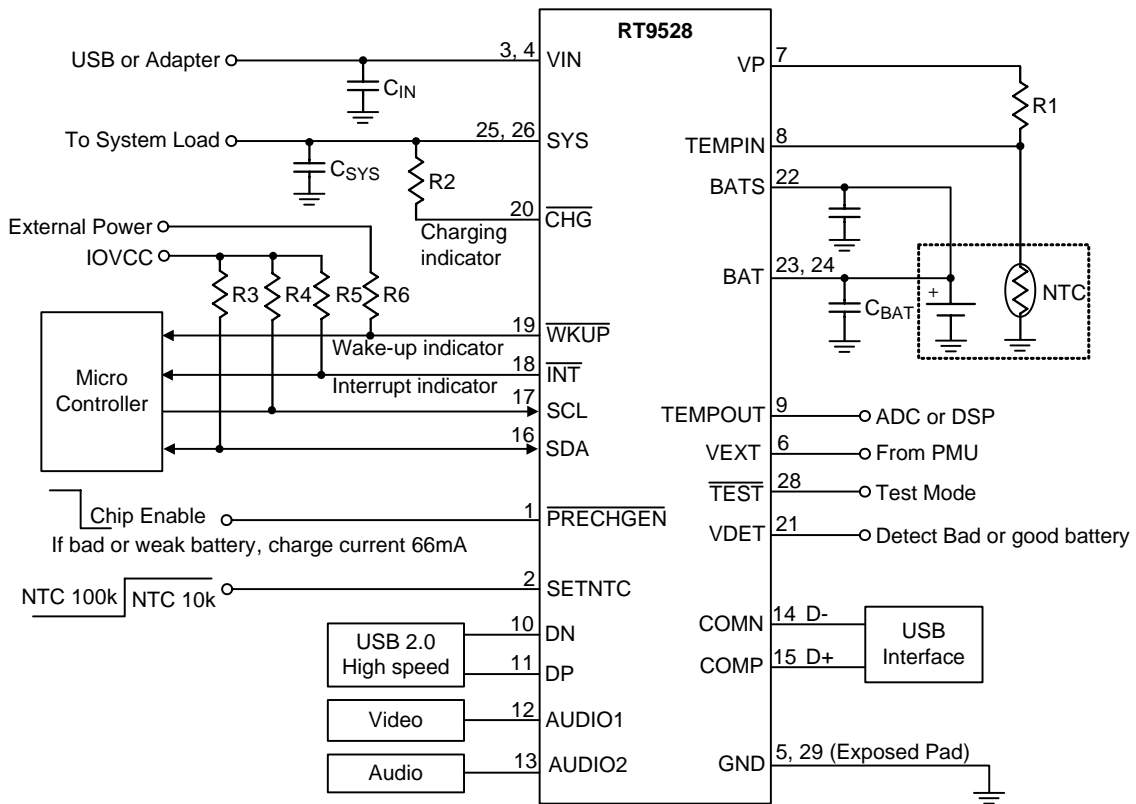

Functional Pin Description

Pin No.	Pin Name	Pin Function
1	$\overline{\text{PRECHGEN}}$	66mA auto charging enable for weak and dead battery. H = disable, L = enable 200k Ω pull low.
2	SETNTC	Set NTC Initial Condition Input. H = NTC resistor 10k Ω , L = NTC resistor 100k Ω . 200k Ω pull low.
3, 4	VIN	Power Input.
5, 29 (Exposed Pad)	GND	Ground. The exposed pad must be soldered to a large PCB and connected to GND for maximum power dissipation.
6	VEXT	External power for the power of TS LDO. Note the power of TS_LDO will choose maximum voltage between VEXT and VDDA.
7	VP	3.3V LDO Output. The regulator only provides thermistor with resistor power.
8	TEMPIN	Detect the Presence of Battery. Connect TEMPIN to NTC thermistor.
9	TEMPOUT	Connect to ADC of DSP.
10	DN	USB Input for D-.
11	DP	USB Input for D+.
12	AUDIO1	Audio or Video Input.
13	AUDIO2	Audio or Video Input.
14	COMN	Common Output N. Connect to D- on mini/micro USB connector.
15	COMP	Common Output P. Connect to D+ on min/micro USB connector.
16	SDA	I ² C Serial Data Input/Output. Connect an external pull up resistor.
17	SCL	I ² C Serial Clock Input. Connect an external pull up resistor.
18	$\overline{\text{INT}}$	Interrupt Status Open-Drain Output. Connect an external pull up resistor. Initial active low.
19	$\overline{\text{WKUP}}$	Power Good Status Open-Drain Output. Connect an external pull up resistor. Active low.
20	$\overline{\text{CHG}}$	Charging Status Open-Drain Output. Connect an external pull up resistor. Active low.
21	VDET	Voltage Detection Input.
22	BATS	Battery Sense. Connect battery.
23, 24	BAT	Battery Charge Current Output.
25, 26	SYS	Connect this pin to a system with a minimum 10 μ F ceramic capacitor to GND.
27	NC	No Internal Connection.
28	$\overline{\text{TEST}}$	Test Mode. Internal 200k Ω pull up. H : Normal, L : Test mode, USB switch turn on and set USB 500mA mode. If $\overline{\text{TEST}}$ = L, RT9528 will set PRECHGEN = 1 internally.

Function Block Diagram

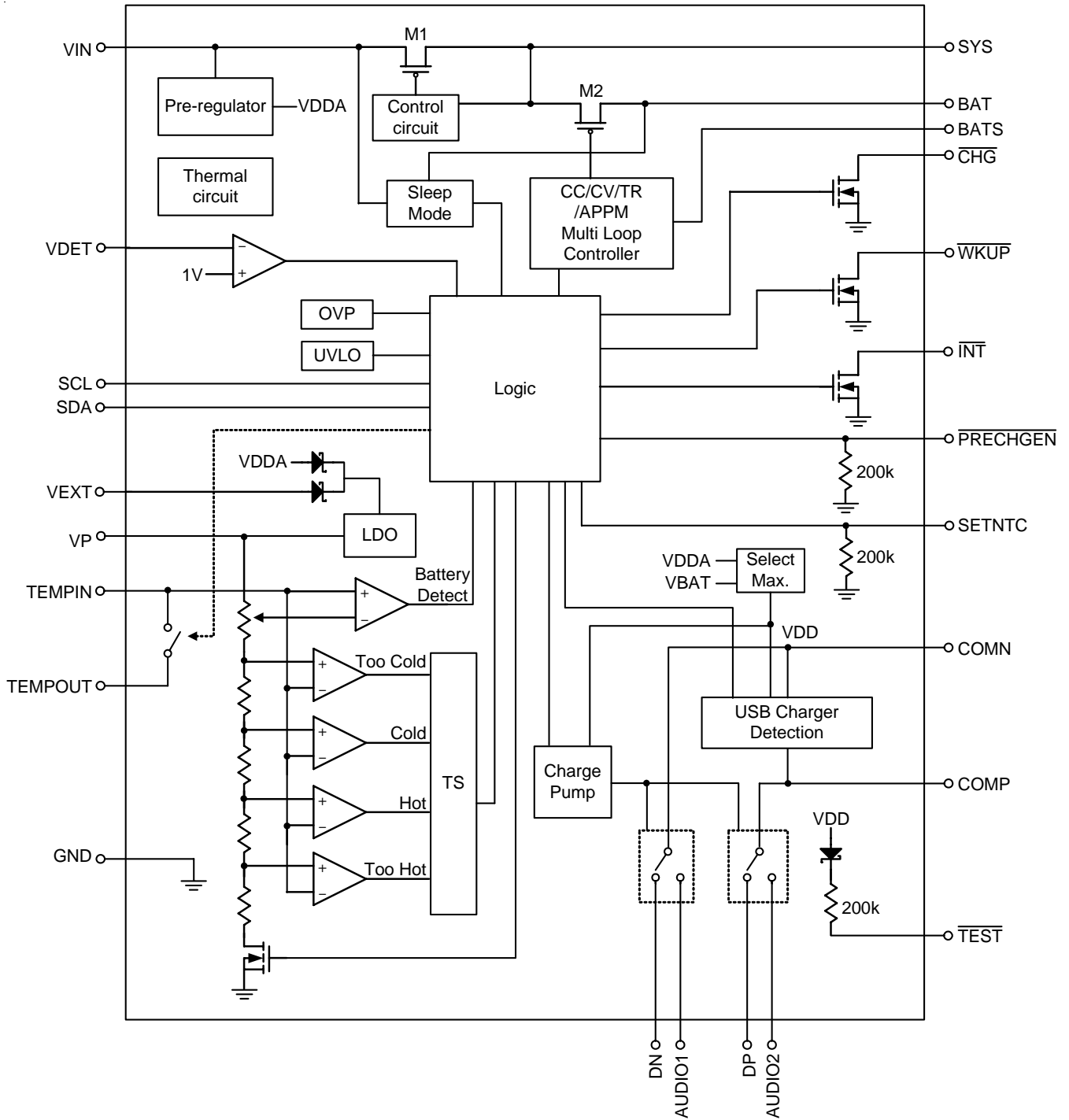

Absolute Maximum Ratings (Note 1)

- Supply Input Voltage, V_{IN} ----- -0.3V to 28V
- SETNTC, PRECHGEN ----- -0.3V to 28V
- Other Pins ----- -0.3V to 6V
- BAT Continuous Current (between BAT and SYS pins) (Note 2) ----- 2.5A
- Power Dissipation, P_D @ $T_A = 25^\circ C$
 WQFN-28L 4x4 ----- 1.923W
- Package Thermal Resistance (Note 3)
 WQFN-28L 4x4, θ_{JA} ----- $52^\circ C/W$
 WQFN-28L 4x4, θ_{JC} ----- $7^\circ C/W$
- Lead Temperature (Soldering, 10 sec.) ----- $260^\circ C$
- Junction Temperature ----- $150^\circ C$
- Storage Temperature Range ----- $-65^\circ C$ to $150^\circ C$
- ESD Susceptibility (Note 4)
 HBM (Human Body Mode) ----- 2kV
 MM (Machine Mode) ----- 200V

Recommended Operating Conditions (Note 5)

- Supply Input Voltage Range, V_{IN} (ISETL = 1) ----- 4.35V to 6V
- Supply Input Voltage Range, V_{IN} (ISETL = 0) ----- 4.45V to 6V
- Supply Input Voltage Range, V_{EXT} (If VIN No Use) ----- 4V to 5.5V
- Junction Temperature Range ----- $-40^\circ C$ to $125^\circ C$
- Ambient Temperature Range ----- $-40^\circ C$ to $85^\circ C$

Electrical Characteristics

($V_{IN} = 5V$, $V_{BAT} = 4V$, $T_A = 25^\circ C$, unless otherwise specified)

Parameter	Symbol	Test Conditions	Min	Typ	Max	Unit
Supply Input Voltage						
VIN Under Voltage Lockout Threshold	V_{UVLO}		3.1	3.3	3.5	V
VIN Under Voltage Lockout Hysteresis	V_{UVLO_HYS}		--	240	--	mV
VIN-BAT VOS Rising	V_{OS_H}		--	100	200	mV
VIN-BAT VOS Falling	V_{OS_L}		10	50	--	mV
Voltage Regulation						
Battery Regulation Voltage	V_{REG}	Set by I^2C , 20mV/step	3.5	--	4.26	V
Battery Regulation Voltage Accuracy	V_{REG2}	$V_{REG} = 4.2V$, $0^\circ C$ to $85^\circ C$	4.16	4.2	4.23	V
System Regulation Voltage	V_{SYS1}	Set by I^2C , $I_{SYS} = 800mA$	4.3	4.4	4.5	V
System Regulation Voltage	V_{SYS2}	$V_{IN} = 6V$, Set by I^2C , $I_{SYS} = 800mA$	5.3	5.5	5.7	V
APPM Regulation Voltage	V_{APPM}	ISETL = 0, ISETU = 1	3.85	3.95	4.05	V
DPM Regulation Voltage	V_{DPM}	ISETL = 0, ISETU = X	4.3	4.4	4.5	V

Parameter	Symbol	Test Conditions	Min	Typ	Max	Unit
VIN to VSYS MOSFET Ron	R _{DS(ON)}	I _{VIN} = 1A, ISETL = 1	--	0.25	0.5	Ω
BAT to VSYS MOSFET Ron	R _{DS(ON)}	V _{BAT} = 4.2V, I _{SYS} = 1A	--	0.05	0.1	Ω
Re-charge Threshold	ΔV _{RECHG}	V _{REG} – Recharge level	60	100	140	mV
Current Regulation						
Charge Current Setting Range	I _{CHG}	Set by I ² C, 16 steps	66	--	1200	mA
Charge Current Setting Range 2	I _{CHG2}	I _{CHG} = 600mA	570	600	630	mA
VIN Current Limit	I _{VIN}	ISETL = 1, (1.5A mode)	1.2	1.5	1.8	A
		ISETL = 0, ISETU = 1 (500mA mode)	450	475	500	mA
		ISETL = 0, ISETU = 0 (100mA mode)	90	95	100	mA
Pre-Charge						
BAT Pre-Charge to Fast-Charge Threshold	V _{PRECH-R}	Set by I ² C, V _{BAT} Rising	2.4	--	3.1	V
BAT Pre-Charge to Fast-Charge Threshold 2	V _{PRECH-R2}	V _{BAT} = 3V, V _{BAT} Rising	2.9	3	3.1	V
BAT Pre-Charge Threshold Hysteresis	ΔV _{PRECH}	V _{BAT} Falling	--	200	--	mV
Pre-Charge Current	I _{PRECH}	Set by I ² C, V _{BAT} = 2V,	40	--	100	mA
Pre-Charge Current 2	I _{PRECH2}	I _{PRECH} = 60mA, V _{BAT} = 2V,	48	60	72	mA
Charge Termination Detection						
Termination Current Ratio to Fast Charge	I _{TERM}	Set by I ² C	0	--	35	%
Termination Current Ratio to Fast Charge 2	I _{TERM2}	I _{TERM} = 10%	5	10	15	%
Timer						
Time Out (Pre-Charge)	t _{PCHG}	Set by I ² C	30	--	60	Min.
Time Out (Fast-Charge)	t _{FCHG}	Set by I ² C	240	--	480	Min.
Time Out for Pre-Charge (Stand-alone)	t _{PCHG1}	Time (Pre) = 30min	22.5	30	37.5	Min.
Time Out for Fast-Charge (Stand-alone)	t _{FCHG1}	Time (Fast) = 240min	180	240	300	Min.
WKUP Deglitch Time	t _{WKUP}	$\overline{\text{PRECHGEN}} = \text{H}$	--	--	1	s
Input Over Voltage Blanking Time	t _{OVP}		--	50	--	μs
Pre-Charge to Fast-Charge Deglitch Time	t _{PF}		--	25	--	ms
Fast-Charge to Pre-Charge Deglitch Time	t _{FP}		--	25	--	ms
Termination Deglitch Time	t _{TERMI}		--	25	--	ms
Recharge Deglitch Time	t _{RECHG}		--	100	--	ms
Input Power Loss to SYS LDO Turn-Off Delay Time	t _{No-in}	V _{IN} > V _{UVLO} , V _{IN} falling until less than V _{BAT}	--	25	--	ms
Pack Temperature Fault Detection Deglitch Time	t _{TS}		--	25	--	ms

Parameter	Symbol	Test Conditions	Min	Typ	Max	Unit
Short-Circuit, Deglitch Time	t _{SHORT}		--	256	--	μs
Short-Circuit, Recovery Time	t _{SHORT_R}		--	64	--	ms
Session valid to connect for PD with Dead or Week Battery	t _{SVLD_Con_WKB}		15	--	45	Min.
Login Input/Output						
$\overline{\text{INT}}$ Pull Down Voltage	V _{INT}	I _{INT} = 5mA	--	200	--	mV
$\overline{\text{CHG}}$ Pull Down Voltage	V _{CHG}	I _{CHG} = 5mA	--	200	--	mV
$\overline{\text{WKUP}}$ Pull Down Voltage	V _{WKUP}	I _{WKUP} = 5mA	--	200	--	mV
$\overline{\text{PRECHGEN}}$, $\overline{\text{SETNTC}}$, $\overline{\text{TEST}}$ Threshold	V _{LH}		1.5	--	--	V
	V _{LL}		--	--	0.4	V
$\overline{\text{PRECHGEN}}$ Pull Low Resistor	R _{PRECHGEN}		--	200	--	kΩ
$\overline{\text{SETNTC}}$ Pull Low Resistor	R _{SETNTC}		--	200	--	kΩ
Digital Signals (SCL, SDA) for I²C						
Logic Input Voltage	Logic-High	V _{IH}	1.5	--	--	V
	Logic-Low	V _{IL}	--	--	0.4	
Input Leakage Current	I _{INLEAK}		-1	--	1	μA
Open Drain Low for SDA	V _{ODLO}	I _{SINK} = 1mA	--	--	0.4	V
Protection						
Thermal Regulation	T _{REG}		--	125	--	°C
Thermal Shutdown Temperature	T _{SD}		--	155	--	°C
Thermal Shutdown Hysteresis	ΔT _{SD}		--	20	--	°C
OVP SET Voltage	V _{OVP}	V _{IN} Rising	6.25	6.5	6.75	V
OVP Hysteresis	V _{OVP_Hys}		--	100	--	mV
VDET	V _{DET}	V _{DET} Falling	0.98	1	1.02	V
BATON	V _{BATON}	V _{TEMPIN} Rising	93	95	97	%VP
Output Short-Circuit Detection Threshold	V _{SHORT}	V _{BAT} - V _{SYS}	--	300	--	mV
VP						
VP (internal used only)	VP	V _{IN} = 5V or V _{IN} = 0V (V _{EXT} > 4V), I _{VP} = 1mA, T _A = 0 to 85°C	3.2	3.3	3.4	V
RNTC = 100kΩ (0, 10, 45, 58°C) NCP15WF104F03RC						
Too Cold temperature Fault Threshold voltage	V _{Too_Cold}	Rising Threshold	--	78	--	%VP
		Hysteresis	--	1	--	
Cold temperature Fault Threshold voltage	V _{Cold}	Rising Threshold	--	67.5	--	%VP
		Hysteresis	--	1	--	
Hot temperature Fault Threshold voltage	V _{Hot}	Falling Threshold	--	29	--	%VP
		Hysteresis	--	1.5	--	
Too Hot temperature Fault Threshold voltage	V _{Too_Hot}	Falling Threshold	--	19.5	--	%VP
		Hysteresis	--	1.5	--	

Parameter	Symbol	Test Conditions	Min	Typ	Max	Unit
RNTC = 10kΩ (0, 10, 45, 58°C) NCP15XH103F03RC						
Too Cold temperature Fault Threshold Voltage	V _{Too_Cold}	Rising Threshold	--	73	--	%VP
		Hysteresis	--	1	--	
Cold temperature Fault Threshold Voltage	V _{Cold}	Rising Threshold	--	64	--	%VP
		Hysteresis	--	1	--	
Hot temperature Fault Threshold Voltage	V _{Hot}	Falling Threshold	--	33	--	%VP
		Hysteresis	--	1.5	--	
Too Hot temperature Fault Threshold Voltage	V _{Too_Hot}	Falling Threshold	--	24.5	--	%VP
		Hysteresis	--	1.5	--	
USB/ Audio/ Video Switches and Charger Detect						
Internal Switch Supplies	V _{SWPOS}		--	3	--	V
Internal Switch Supplies	V _{SWNEG}		--	-2	--	V
VBAT UVLO	V _{BAT_UVLO}		1.3	1.8	2.3	V
VBAT Supply Current	I _{VBAT}	V _{BAT} = 4.2V, V _{IN} = 0V, CP_EN = 0, SDA = SCL = 0V	--	5	10	μA
	I _{VBAT2}	V _{BAT} = 4.2V, V _{IN} = 0V, CP_EN = 1, SDA = SCL = 0V	--	30	--	
VIN Supply Current by Suspend	I _{VIN_USUS}	V _{IN} = 5V, V _{BAT} = 0V, CP_EN = 1, USUS = 1, LDO_TS = 0, TS = 0	--	--	300	μA
VDP_SRC Voltage	V _{DP_SRC}	With I _{DAT_SRC} = 0 to 250μA	0.5	--	0.7	V
VDM_SRC Voltage	V _{DM_SRC}	With I _{DAT_SRC} = 0 to 250μA	0.5	--	0.7	V
V _{DAT_REF} Voltage	V _{DAT_REF}		0.25	--	0.4	V
VLGC Voltage	V _{LGC}		0.8	--	2	V
IDM_SINK Current	I _{DM_SINK}	V _{COMN} = 0.6V	50	--	150	μA
IDP_SINK Current	I _{DP_SINK}	V _{COMP} = 0.6V	50	--	150	μA
RDM_DWN	R _{DM_DWN}		14.25	--	24.8	kΩ
IDP_SRC	I _{DP_SRC}	V _{COMP} = 0.8V	1	--	13	μA
V _{COMP_DCD}	V _{COMP_DCD}	In DCD flow, V _{COMP} = Float	2	--	--	V
USB Analog Switch (DN1, DP2)						
Analog Signal Range	V _{DN1} , V _{DP2}	CP_EN = 0	0	--	V _{SWPOS}	V
		CP_EN = 1	V _{SWNEG}	--	V _{SWPOS}	
On-Resistance	R _{ONUSB}	V _{IN} = 5V, V _{BAT} = 3V, CP_EN = 1, I _{COM} = 10mA, V _{COM} = 0V to 3V	--	4	--	Ω
On-Resistance Match Between Channels	ΔR _{ONUSB}	V _{IN} = 5V, V _{BAT} = 3V, CP_EN = 1, I _{COM} = 10mA, V _{COM} = 400mV	--	0.5	--	Ω
Off Leakage Current	I _{USB(OFF)}	V _{IN} = 5V, V _{BAT} = 4.2V, Switch open, V _{DN1} or V _{DP2} = 0.3V, 2.5V, V _{COM} = 2.5V, 0.3V	-360	--	360	nA
On Leakage Current	I _{USB(ON)}	V _{IN} = 5V, V _{BAT} = 4.2V, Switch closed, V _{DN1} or V _{DP2} = 0.3V, 2.5V, V _{COM} and V _{AUD} = Float	-360	--	360	nA

Parameter	Symbol	Test Conditions	Min	Typ	Max	Unit
Audio Analog Switch (AUD1, AUD2)						
Analog Signal Range	V _{AUDIO}	CP_EN = 0	0	--	V _{SWPOS}	Ω
		CP_EN = 1	V _{SWNEG}	--	V _{SWPOS}	
On-Resistance Match Between Channels	ΔR _{DS(ON)A}	V _{IN} = 0V, V _{BAT} = 3V, CP_EN = 1, I _{COM} = 10mA, V _{COM} = 0V	--	0.2	--	Ω
On-Resistance Flatness	R _{FLATA}	V _{IN} = 0V, V _{BAT} = 3V, CP_EN = 1, I _{COM} = 10mA, V _{COM} = -2 to 2V	--	1.5	--	Ω
Off Leakage Current	I _{LA(OFF)}	V _{IN} = 0V, V _{BAT} = 4.2V, Switch open, V _{AUD} = -0.5V, 0.5V, V _{COM} = -0.5 to 0.5V	-360	--	360	nA
On Leakage Current	I _{LA(ON)}	V _{IN} = 0V, V _{BAT} = 4.2V, Switch closed, V _{AUD} = -2V, 2V, V _{COM} and V _{DX} = Float	-360	--	360	nA
Shunt Resistor	R _{SHUNT}		30	100	200	Ω
Dynamic						
I ² C Max Clock	F _{I2CCLK}		--	--	400	kHz
CP_EN delay time	t _{CP_EN}	Not production tested	--	--	1	ms
Analog Switch Turn On Time	t _{ON}	I ² C Stop to Switch On, R _L = 32Ω	--	--	1	ms
Analog Switch Turn Off Time	t _{OFF}	I ² C Stop to Switch Off, R _L = 32Ω	--	--	1	ms
Break-Before-Make Delay Time	t _D	R _L = 32Ω	>0	--	--	μs
Data Contact Detect Debounce	t _{DCD_DBNC}		20	--	40	ms
DCD Time-OUT	t _{DCD_TO}		300	--	900	ms
V _{DATA} _SRC ON Time	t _{DP_SRC_ON}		40	--	--	ms
Off-Isolation(DN, DP)	V _{ISO}	R _L = 32Ω, f = 20kHz, V _{COM} = 2V _{p-p} ,	--	TBD	--	dB
Off-Isolation(AUDIO1/2)	V _{ISO}	R _L = 32Ω, f = 20kHz, V _{COM} = 0.5V _{p-p} ,	--	TBD	--	dB
Cross-talk	V _{CT}	R _L = 32Ω, f = 20kHz, V _{COM} = 1V _{RMS}	--	-11 0	--	dB
Total Harmonic Distortion for Audio	T _{HD}	F = 20Hz to 20kHz, V _{COM} = 2V _{p-p} , R _L = 32Ω, DC bias = 0	--	0.1	--	%
Capacitance (Note 2)						
DP/Audio2 , DN/Audio1 ON Capacitance	C _{ON} (DP/Audio2, DN/Audio1)	USB on, f = 240MHz	--	4.5	--	pF
		Audio on, f = 1Mhz	--	9	--	pF
USB Input source OFF Capacitance	C _{OFF} (DP/DN)	f = 1MHz	--	1.5	--	pF
Audio(Audio2/Audio1)	C _{OFF} (Audio2/Audio1)	f = 1MHz	--	3	--	pF

Note 1. Stresses beyond those listed “Absolute Maximum Ratings” may cause permanent damage to the device. These are stress ratings only, and functional operation of the device at these or any other conditions beyond those indicated in the operational sections of the specifications is not implied. Exposure to absolute maximum rating conditions may affect device reliability.

Note 2. Guaranteed by design.

Note 3. θ_{JA} is measured at $T_A = 25^\circ\text{C}$ on a high effective thermal conductivity four-layer test board per JEDEC 51-7. θ_{JC} is measured at the exposed pad of the package.

Note 4. Devices are ESD sensitive. Handling precaution is recommended.

Note 5. The device is not guaranteed to function outside its operating conditions.

Typical Operating Characteristics

$V_{IN} = 5V$, unless otherwise specified.

Standard Downstream Port

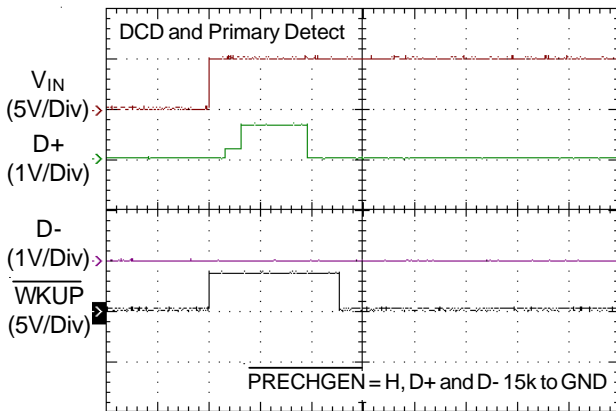

Time (100ms/Div)

Floating

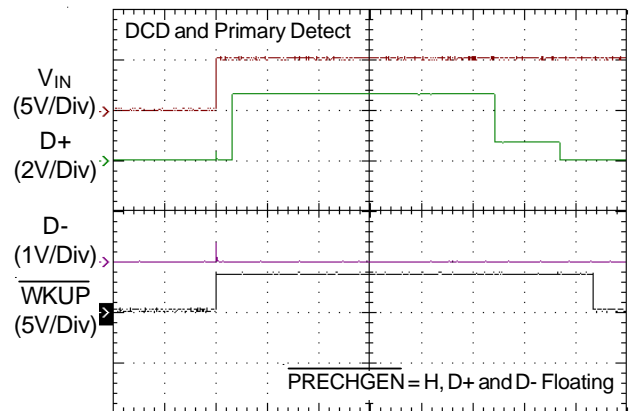

Time (100ms/Div)

Dedicated Charging Port

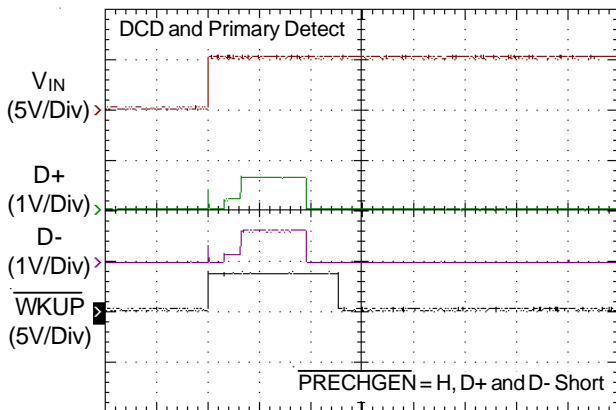

Time (100ms/Div)

Dedicated Charging Port

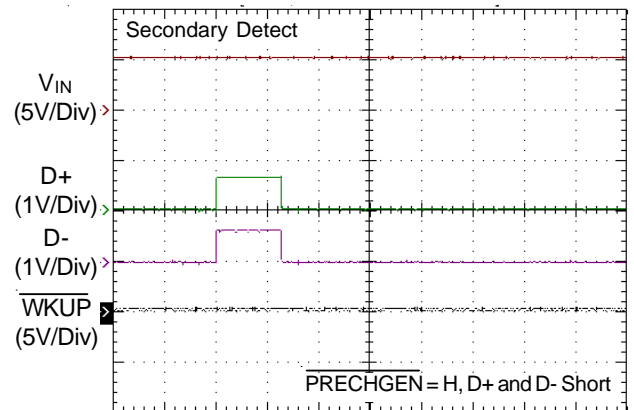

Time (100ms/Div)

In The Dead Battery Flow

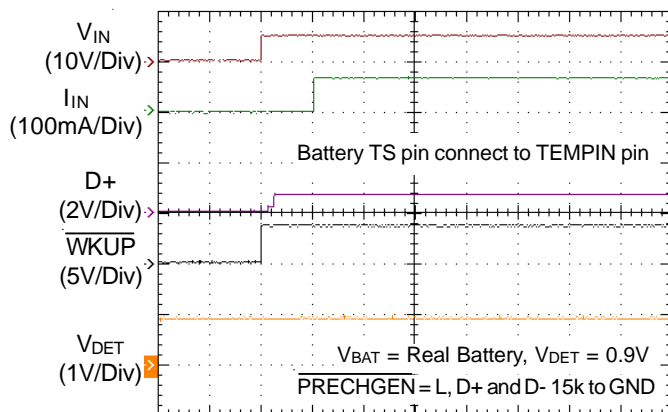

Time (250ms/Div)

Finish Dead Battery Flow

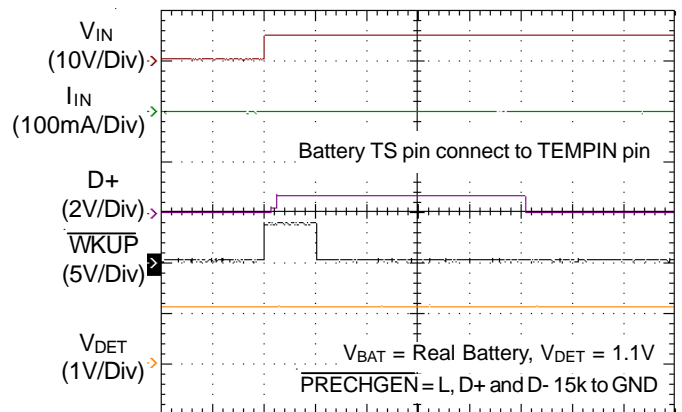

Time (250ms/Div)

Standard 500mA Mode

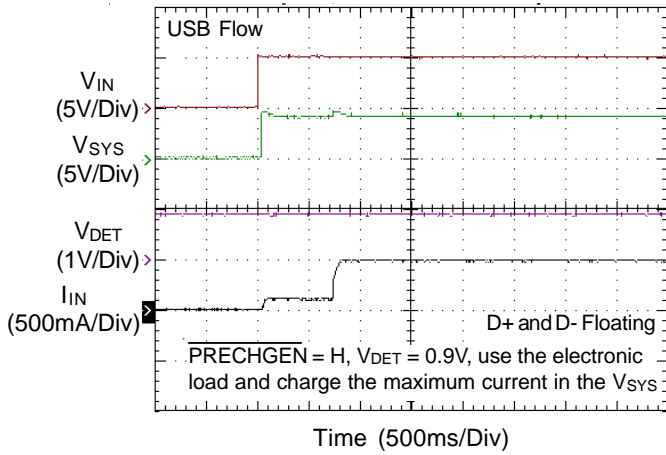

Standard USUS

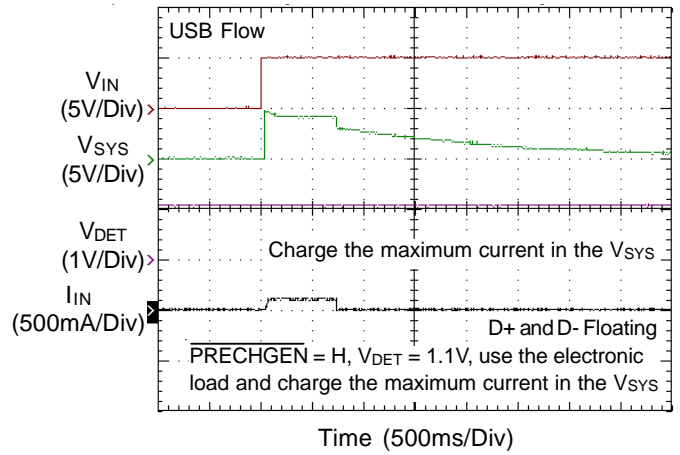

Dedicated Charging Port

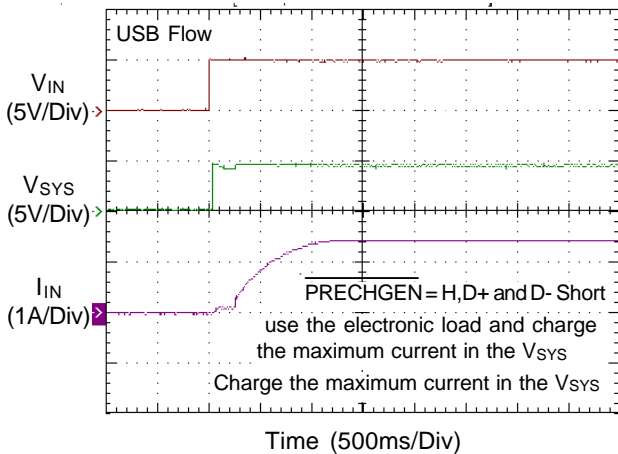

Charge on/Off Control by I²C

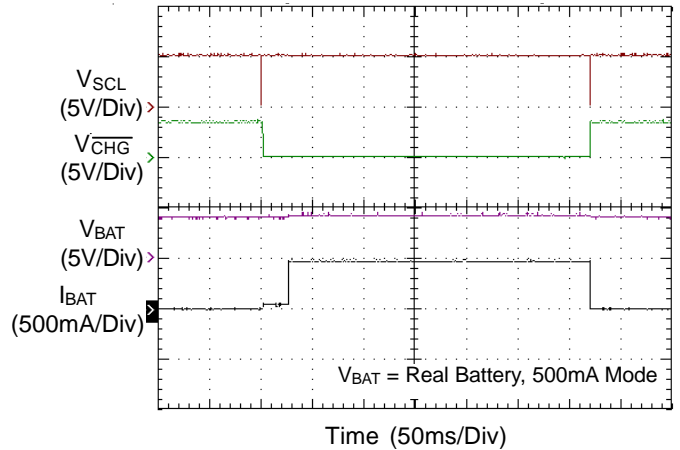

TEMPIN On/Off

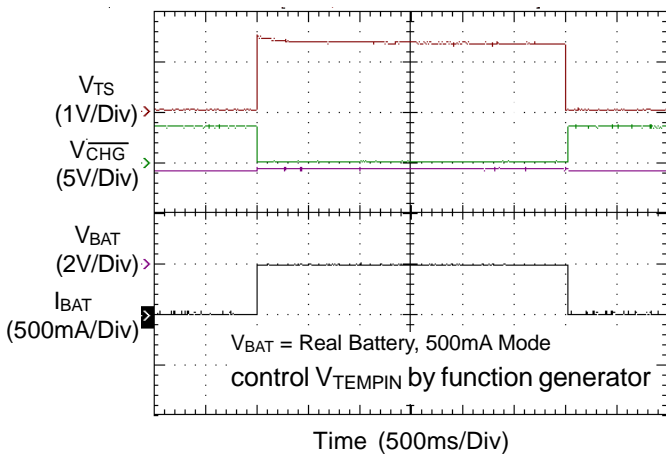

VIN Removal

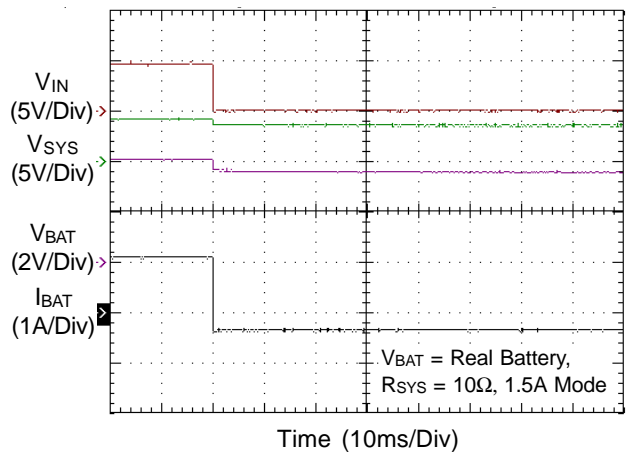

V_{IN} Over Voltage Protection

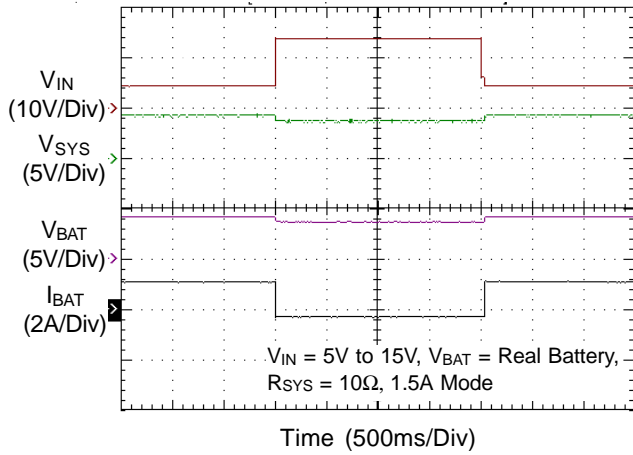

Battery with NTC Resistor Plug-In

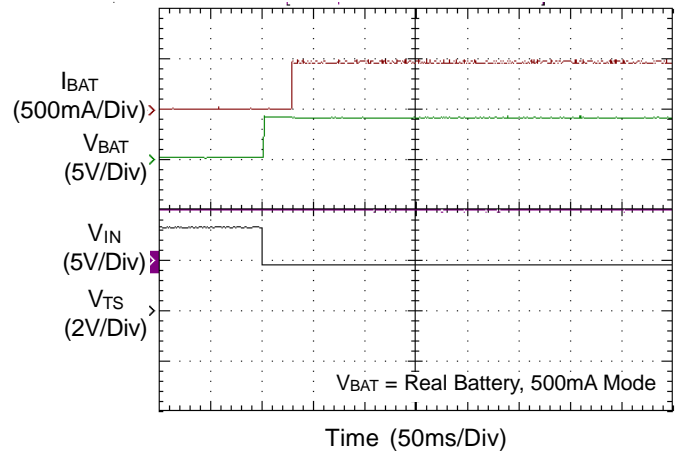

Battery with NTC Resistor Plug-Out

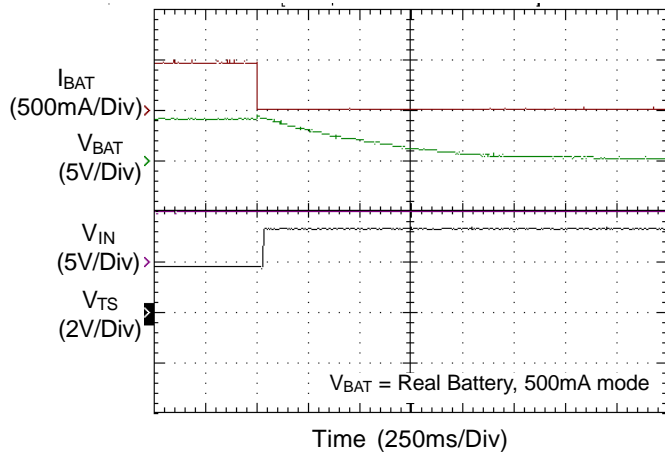

With Battery without NTC Resistor

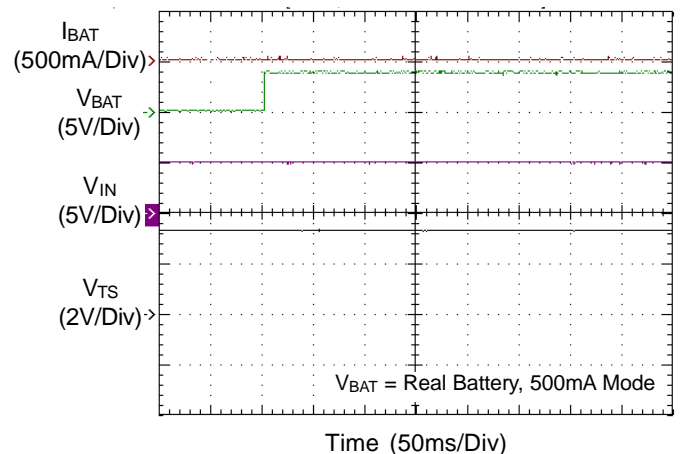

With NTC Resistor without Battery

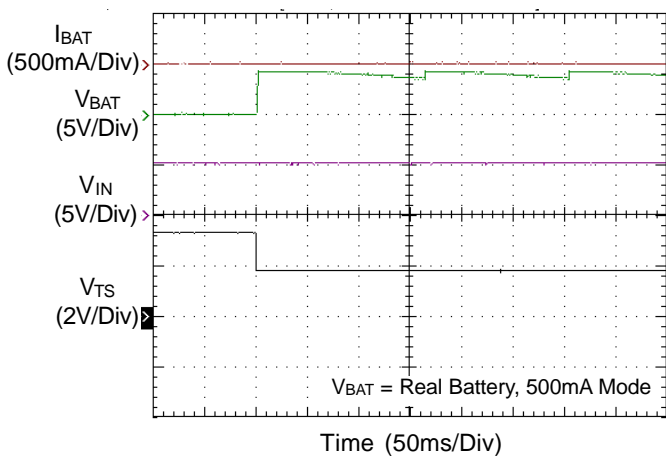

V_{IN} Exist then Negative Battery

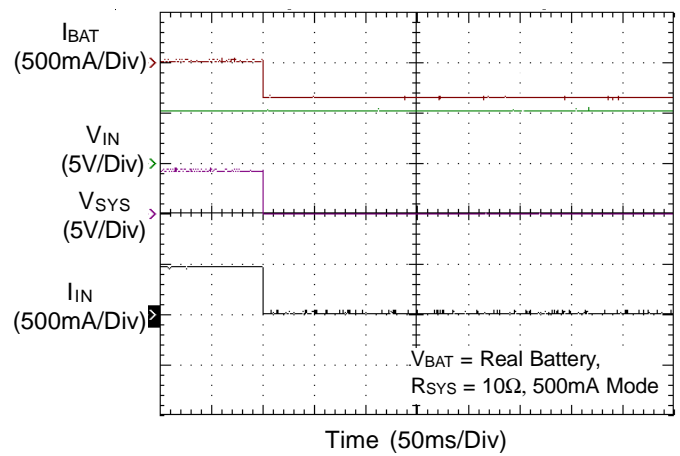

Negative Battery then V_{IN} Plug-In

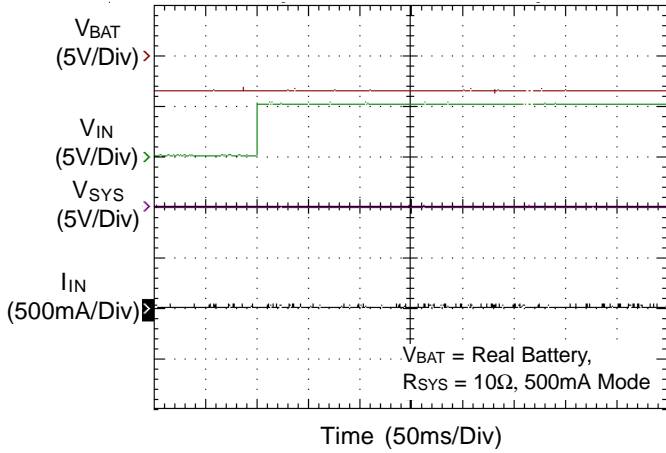

The Temperature of Battery Status

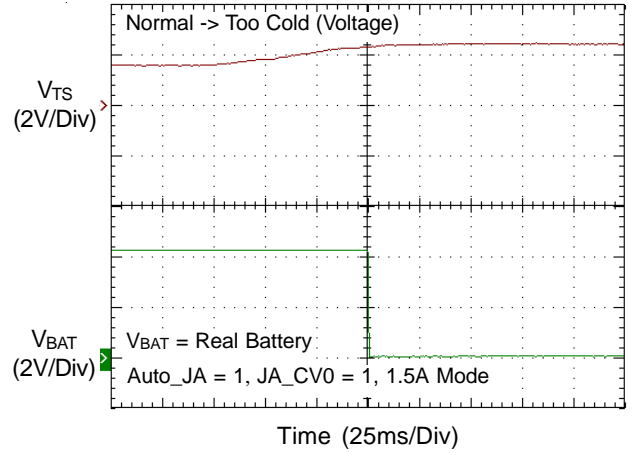

The Temperature of Battery Status

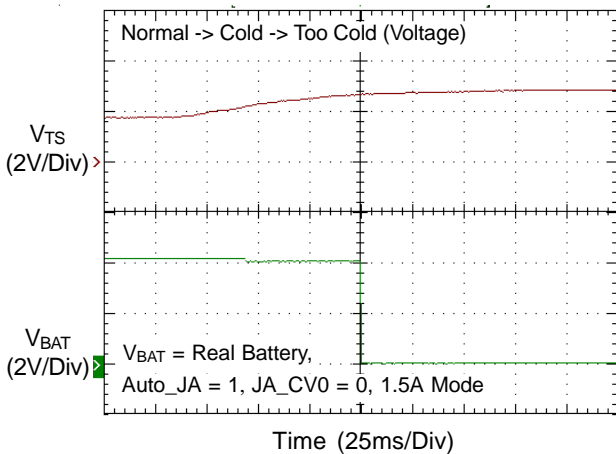

The Temperature of Battery Status

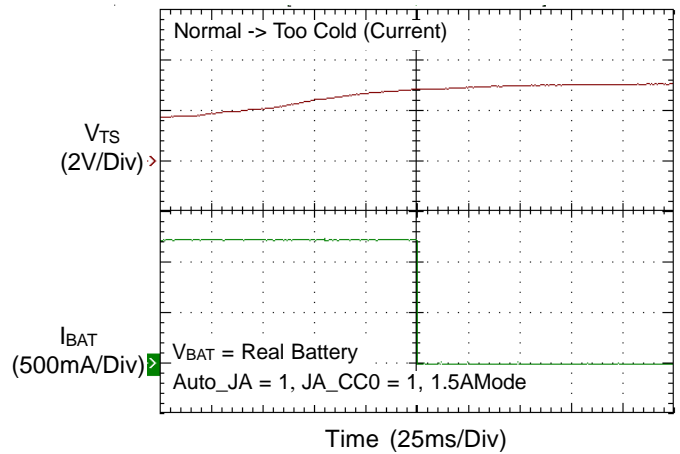

The Temperature of Battery Status

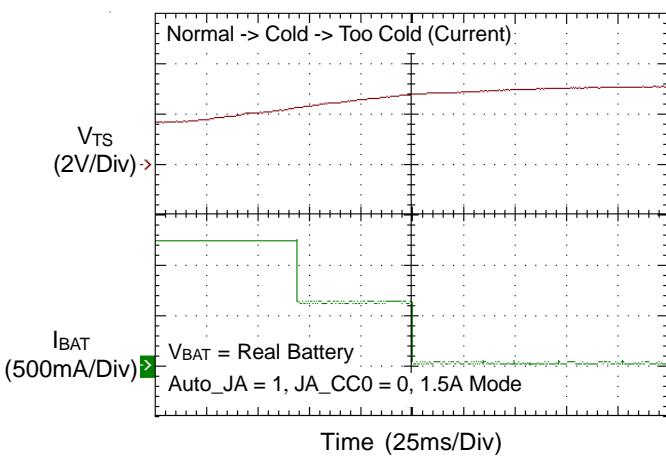

The Temperature of Battery Status

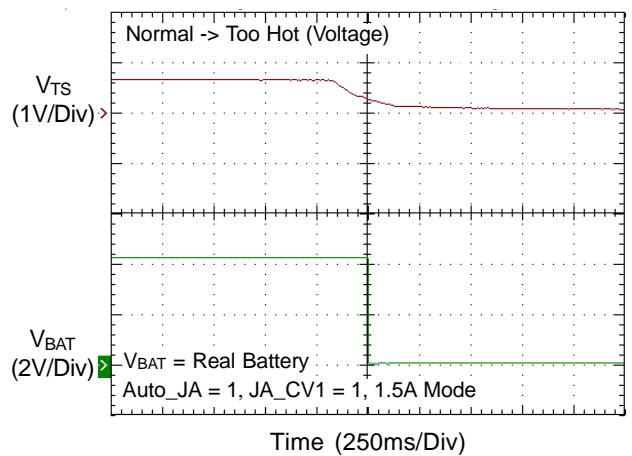

The Temperature of Battery Status

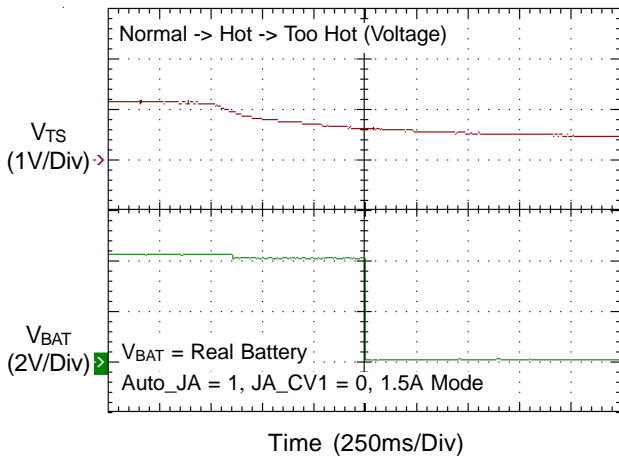

The Temperature of Battery Status

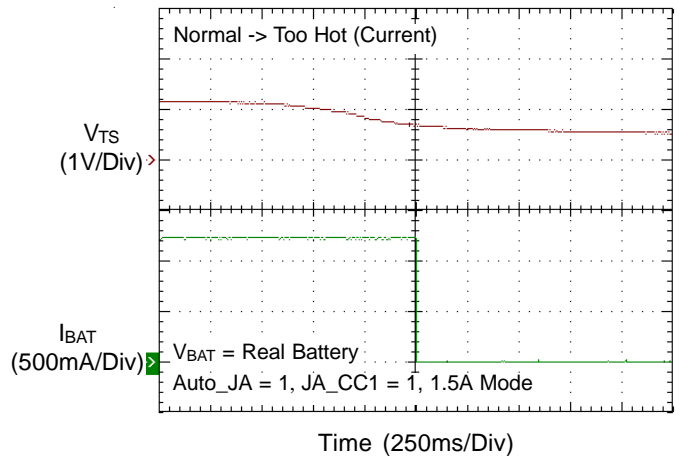

The Temperature of Battery Status

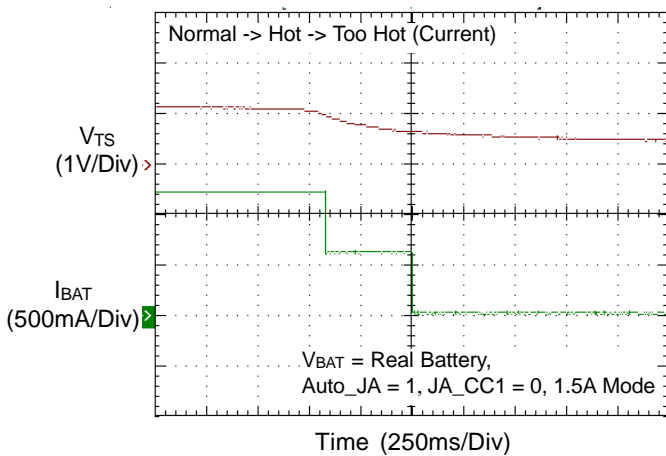

Interrupt Happen

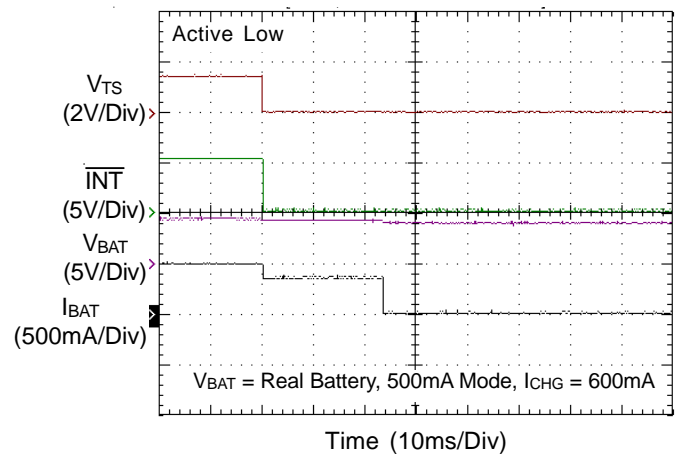

Interrupt Release

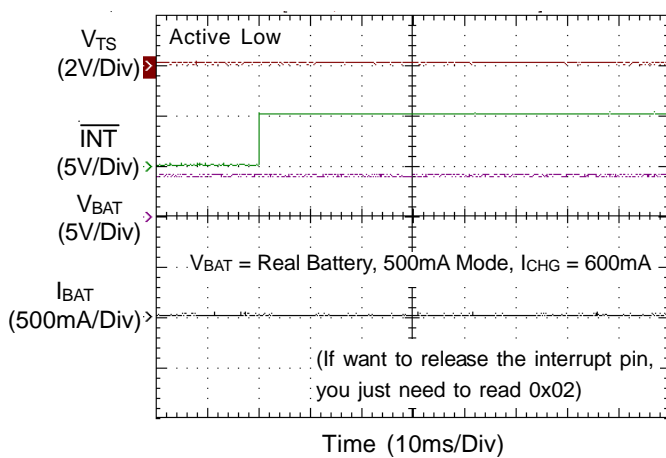

Interrupt Happen

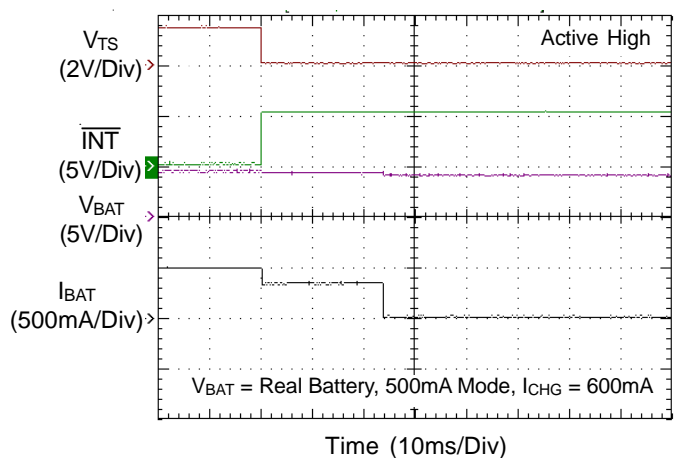

Interrupt Release

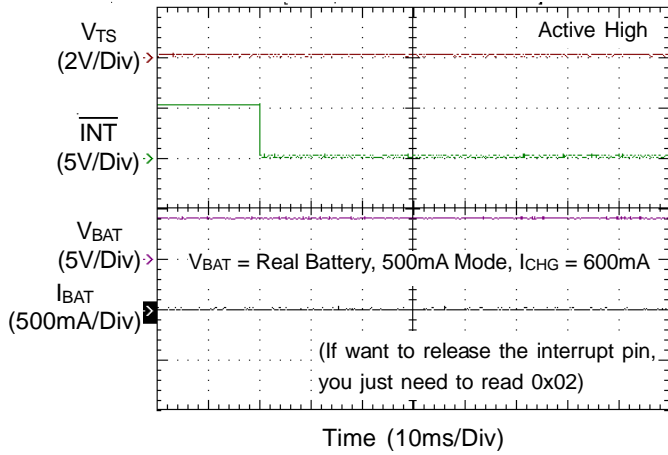

TEST Pin Function

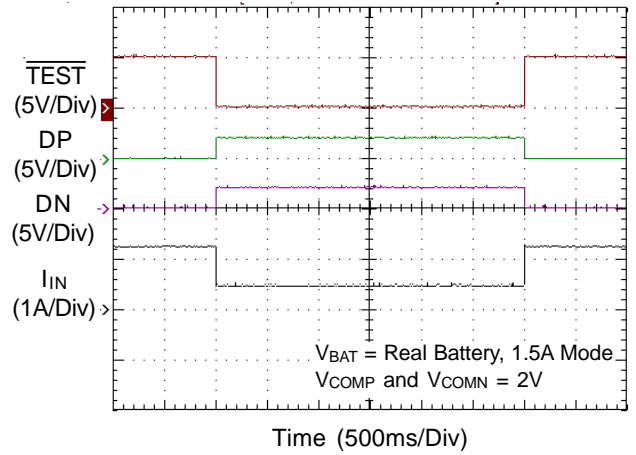

APPM

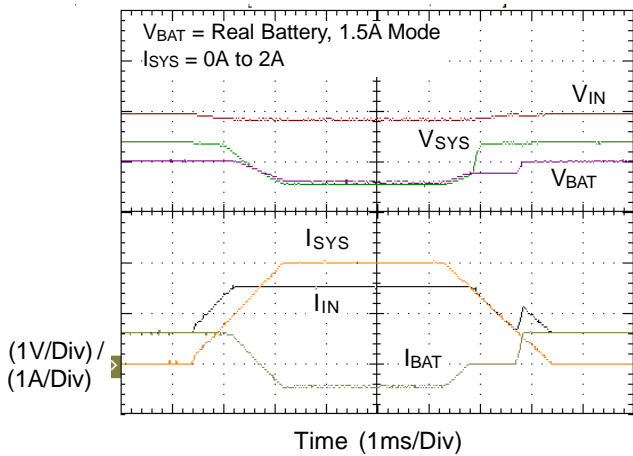

System Regulation Voltage vs. Temperature

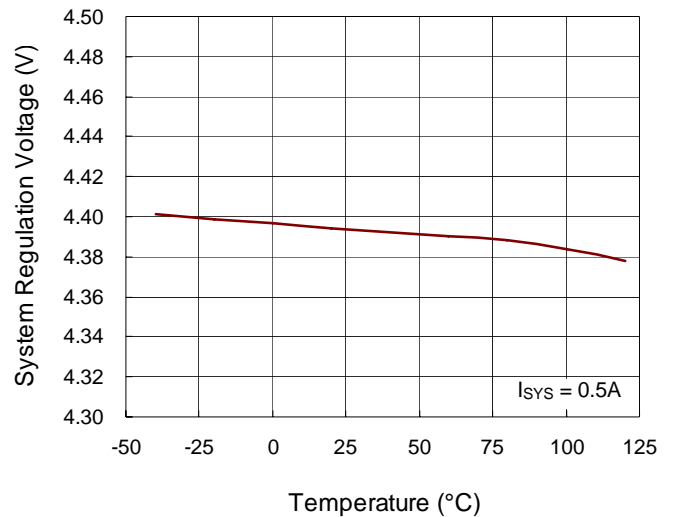

OVP Threshold Voltage vs. Temperature

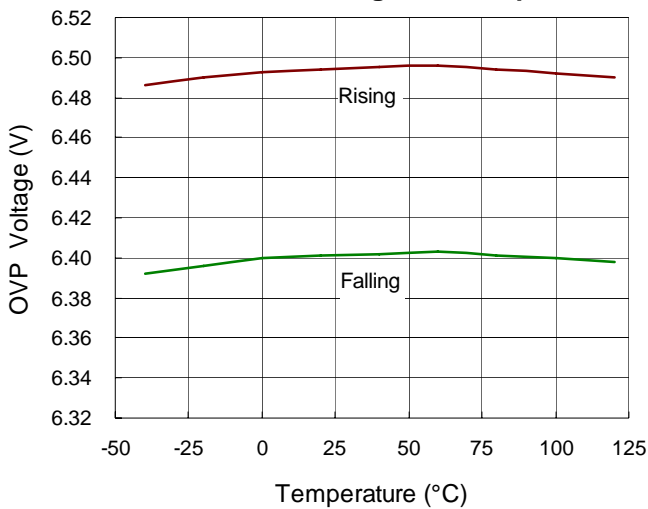

V_{IN} - V_{sys} Dropout Voltage vs. Temperature

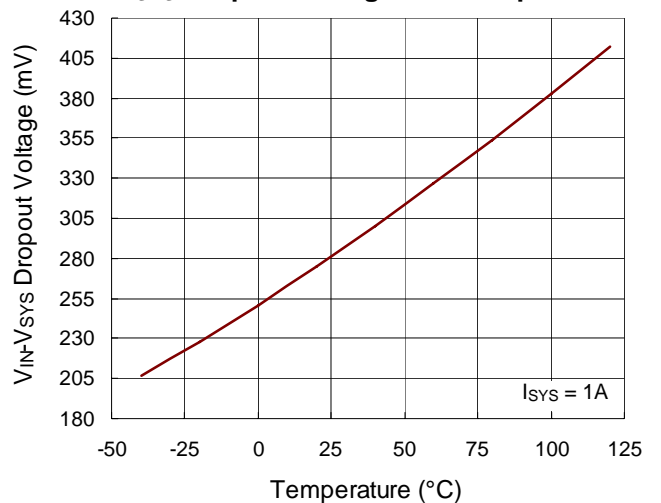

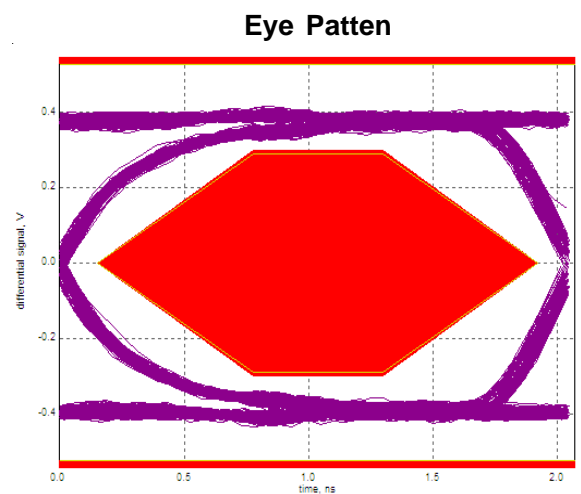
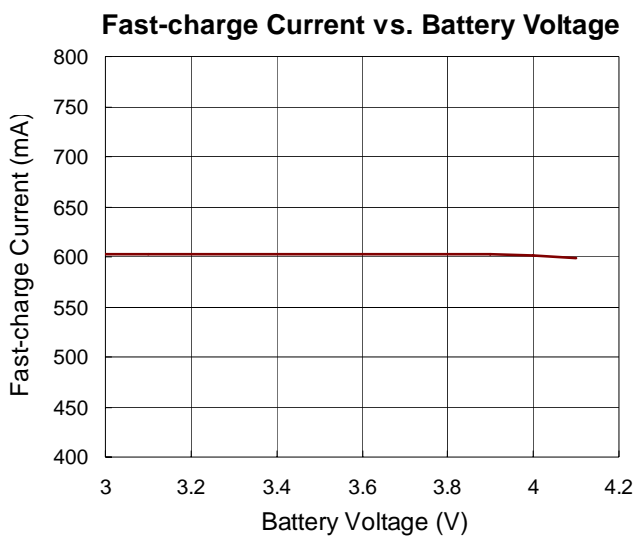
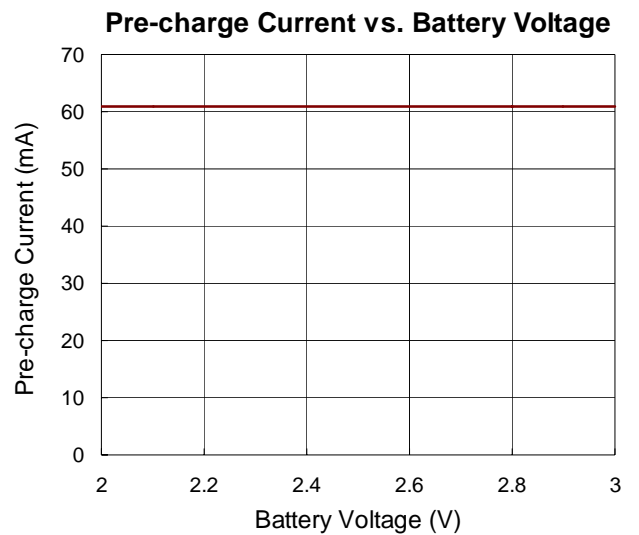
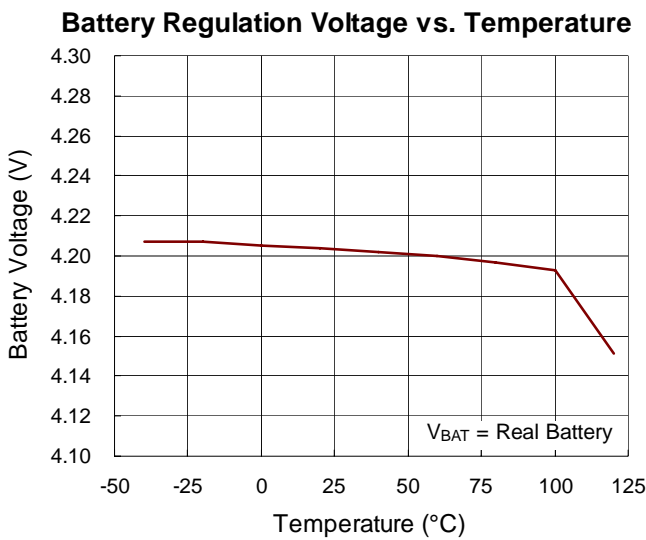
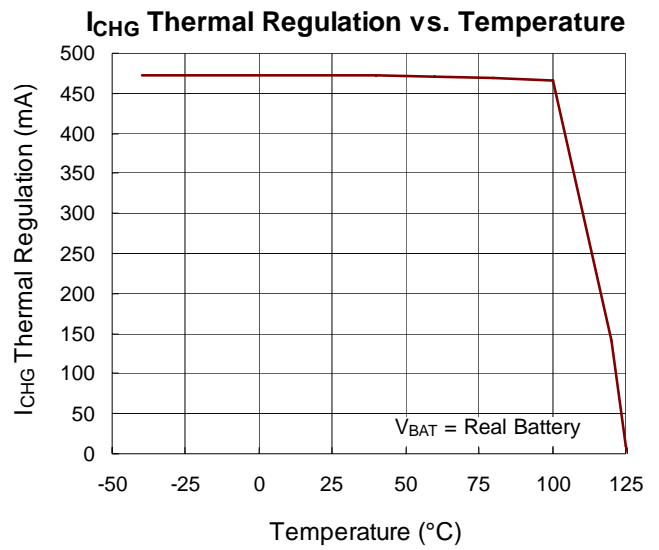
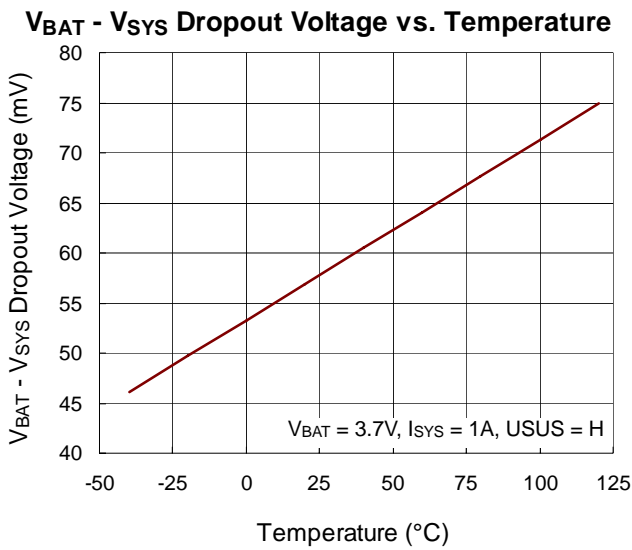

I²C Register Information

Address : 1000101x

Address	Name	Bit7	Bit6	Bit5	Bit4	Bit3	Bit2	Bit1	Bit0
0x00	Base_SET1	USUS	ISETL	ISETU	VSYS_set	Reserved	CHG_EN	Reserved	Reserved
	Reset Value	0	0	0	0	0	0	0	0
	Read/Write	R/W	R/W	R/W	R/W	R/W	R/W	R/W	R/W
Address	Name	Bit7	Bit6	Bit5	Bit4	Bit3	Bit2	Bit1	Bit0
0x01	Base_SET2	INT_OUT	INT_EN	TS	LDO_TS	TS_switch	ASET	NC	Auto_JA
	Reset Value	0	0	1	1	0	1	1	1
	Read/Write	R/W	R/W	R/W	R/W	R/W	R/W	R/W	R/W
Address	Name	Bit7	Bit6	Bit5	Bit4	Bit3	Bit2	Bit1	Bit0
0x02	INT_status	CHGDET	DCD_T	PG2	Termination	TS_change	Battery_absent	Time_fault	VDET_status
	Reset Value	N/A	N/A	N/A	N/A	N/A	N/A	N/A	N/A
	Read/Write	R	R	R	R	R	R	R	R
Address	Name	Bit7	Bit6	Bit5	Bit4	Bit3	Bit2	Bit1	Bit0
0x03	Status1	DCPORT	CHPORT	OVP	UVLO	SLEEP	NC	Pre_CHG	Fast_CHG
	Reset Value	N/A	N/A	N/A	N/A	N/A	N/A	N/A	N/A
	Read/Write	R	R	R	R	R	R	R	R
Address	Name	Bit7	Bit6	Bit5	Bit4	Bit3	Bit2	Bit1	Bit0
0x04	Status2	TS_flag			BAT_NEG	TS_fault	Reserved	Reserved	Reserved
	Reset Value	N/A	N/A	N/A	N/A	N/A	N/A	N/A	N/A
	Read/Write	R	R	R	R	R	R	R	R
Address	Name	Bit7	Bit6	Bit5	Bit4	Bit3	Bit2	Bit1	Bit0
0x05	CTR1	VREG						JA_CV1	JA_CV0
	Reset Value	1	0	0	0	1	1	0	1
	Read/Write	R/W	R/W	R/W	R/W	R/W	R/W	R/W	R/W
Address	Name	Bit7	Bit6	Bit5	Bit4	Bit3	Bit2	Bit1	Bit0
0x06	CTR2	ICHG				IPRE_CHG		JA_CC1	JA_CC0
	Reset Value	0	0	0	0	0	0	1	0
	Read/Write	R/W	R/W	R/W	R/W	R/W	R/W	R/W	R/W
Address	Name	Bit7	Bit6	Bit5	Bit4	Bit3	Bit2	Bit1	Bit0
0x07	CTR3	Itermi			VPRE			Time_out	
	Reset Value	0	0	1	1	1	0	0	0
	Read/Write	R/W	R/W	R/W	R/W	R/W	R/W	R/W	R/W
Address	Name	Bit7	Bit6	Bit5	Bit4	Bit3	Bit2	Bit1	Bit0
0x08	CTR4	RNTC Type		Too Cold			Cold		
	Reset Value	0	0	1	0	0	1	0	0
	Read/Write	R/W	R/W	R/W	R/W	R/W	R/W	R/W	R/W

Address	Name	Bit7	Bit6	Bit5	Bit4	Bit3	Bit2	Bit1	Bit0
0x09	CTR5	CHG_IND_DIS	I ² Cctl	Hot			Too Hot		
	Reset Value	0	0	1	0	0	1	0	0
	Read/Write	R/W	R/W	R/W	R/W	R/W	R/W	R/W	R/W
Address	Name	Bit7	Bit6	Bit5	Bit4	Bit3	Bit2	Bit1	Bit0
0x0a	Bast_SET3	COMP		COMN		CP_EN	CP_AUD	CHG_TYP	USB_CHGDET
	Reset Value	1	1	1	1	0	0	0	1
	Read/Write	R/W	R/W	R/W	R/W	R/W	R/W	R/W	R/W

I²C Table (Detail)

Base_SET1

Address	Name	Bit7	Bit6	Bit5	Bit4	Bit3	Bit2	Bit1	Bit0
0x00	Base_SET1	USUS	ISETL	ISETU	VSYS_set	Reserved	CHG_EN	Reserved	Reserved
	Reset Value	0	0	0	0	0	0	0	0
	Read/Write	R/W	R/W	R/W	R/W	R/W	R/W	R/W	R/W
	USUS	VIN Suspend Control. Turn off M1 LDO and charger function 0 : Disable Suspend function. M1 LDO turn on 1 : Enable Suspend function. M1 LDO turn off							
	ISETL	VIN Current Limit Control. 0 : See ISETU set 1 : 1.5A current limit							
	ISETU	VIN Current Limit Control 0 : 95mA current limit 1 : 475mA current limit							
	VSYS_set	SYS Voltage regulation control 0 : V _{SYS} = 4.4V 1 : V _{SYS} = 5.5V							
	CHG_EN	Charger enable control 0 : Disable charger function 1 : Enable charger function							

Base_SET2

Address	Name	Bit7	Bit6	Bit5	Bit4	Bit3	Bit2	Bit1	Bit0
0x01	Base_SET2	$\overline{\text{INT_OUT}}$	INT_EN	TS	LDO_TS	TS_switch	ISET	NC	Auto_JA
	Reset Value	0	0	1	1	0	1	1	1
	Read/Write	R/W	R/W	R/W	R/W	R/W	R/W	R/W	R/W
	$\overline{\text{INT_OUT}}$	This bit sets the interrupt polarity 0 : Active low 1 : Active High							
	INT_EN	Enables interrupt generation. When set to disabled, it will mask $\overline{\text{INT}}$ pin out. If $\overline{\text{INT_OUT}} = 0$ and INT_EN = 0, $\overline{\text{INT}}$ pin is high impedance. If $\overline{\text{INT_OUT}} = 1$ and INT_EN = 0, INT pin is low. 0 : Disable Interrupt 1 : Enable Interrupt							
	TS	Thermal Sense function and check battery absent function 0 : Disable TS function and check battery absent function 1 : Enable TS function and check battery absent function							
	LDO_TS	The LDO for Thermal Sense 0 : Disable LDO_TS 1 : Enable LDO_TS							
	TS_switch	The switch between TEMPIN and TEMPOUT 0 : Open 1 : Short							
	ISET	SET charge current (If Auto_JA = 1 , ISET can not control charge current) 0 : Half of charge current 1 : Full of charge current							
	Auto_JA	Auto control charge current and voltage by battery temperature 0 : Disable 1 : Enable							

INT_Status

Address	Name	Bit7	Bit6	Bit5	Bit4	Bit3	Bit2	Bit1	Bit0
0x02	INT_status	CHGDET	DCD_T	PG2	Termination	TS_change	Battery_absent	Time_fault	VDET_status
	Reset Value	N/A	N/A	N/A	N/A	N/A	N/A	N/A	N/A
	Read/Write	R	R	R	R	R	R	R	R
	CHGDET	Output of USB Charger detection comparator. This bit will set to one if COMP > VDAT_REF for longer than 20ms. Any change in this bit triggers an interrupt. 0 : COMN < VDAT_REF or COMN > VLGC (High-current charger not detected) 1 : VLGC > COMN > VDAT_REF (High-current charger detected)							
	DCD_T	Data Contact Detect Time Wait. (Interrupt generated for 0 to 1 transition) 0 : Data Contact Detect timer not expired 1 : Data Contact Detect running for >512ms							
	PG2	PG2_status bit. Any change in this bit triggers an interrupt. 0 : No power good. 1 : Power good (no OVP & no UVLO & no SLEEP)							
	Termination	Charge termination bit (latch type, one time, use EN or USUS re-toggle reset) Any change in this bit triggers an interrupt. 0 : Normal 1 : Termination							
	TS_change	TS change bit. (Interrupt generated for 0 to 1 transition) TS_change = 1 triggers an interrupt. After 0x02 is read, TS_change will be set to 0. 0 : Normal 1 : When 0x04 register bit5 to bit7 (TS_flag) status have some changes.							
	Battery_absent	Battery absent bit. Any change in this bit triggers an interrupt. 0 : Normal 1 : Battery absent happen							
	Time_fault	Charger timer fault bit. Any change in this bit triggers an interrupt. 0 : Normal 1 : Time Fault							
	VDET_status	VDET state bit. Any change in this bit triggers an interrupt. 0 : VDET < 1V 1 : VDET > 1V							

I²C_Status1

Address	Name	Bit7	Bit6	Bit5	Bit4	Bit3	Bit2	Bit1	Bit0
0x03	Status1	DCPORT	CHPORT	OVP	UVLO	SLEEP	NC	Pre_CHG	Fast_CHG
	Reset Value	N/A	N/A	N/A	N/A	N/A	N/A	N/A	N/A
	Read/Write	R	R	R	R	R	R	R	R
	DCPORT	Indicates if a Dedicated USB Charger is Connected 0 : No dedicated Charger 1 : Dedicated Charger Detected							
	CHPORT	Indicates if a High Current Host/Hub is Connected 0 : No dedicated HCHH 1 : HCHH Detected							
	OVP	OVP_state bit 0 : VIN Voltage is lower than OVP Threshold Voltage 1 : VIN Voltage is higher than OVP Threshold Voltage							
	UVLO	UVLO_state bit 0 : VIN Voltage is higher than UVLO Threshold Voltage 1 : VIN Voltage is lower than UVLO Threshold Voltage							
	SLEEP	SLEEP_state bit 0 : No sleep , (VIN – 100mV) > V _{BAT} 1 : Sleep state, (VIN – 50mV) < V _{BAT}							
	Pre_CHG	Pre-charge status. If CHG_EN is disabled, Pre_CHG = 0 0 : Not Pre-charge 1 : Pre-charge							
	Fast_CHG	Fast-charge status. If CHG_EN is disabled, Fast_CHG = 0 0 : Not Fast-charge 1 : Fast-charge							

I²C_Status2

Address	Name	Bit7	Bit6	Bit5	Bit4	Bit3	Bit2	Bit1	Bit0
0x04	Status2	TS_flag			BAT_NEG	TS_fault	Reserved	Reserved	Reserved
	Reset Value	N/A	N/A	N/A	N/A	N/A	N/A	N/A	N/A
	Read/Write	R	R	R	R	R	R	R	R
	TS_flag	TS_flag state bit 000 : < (Too Cold) 001 : (Too Cold) ~ (Cold) 010 : Normal 011 : (Hot) ~ (Too Hot) 100 : > (Too Hot) 101 ~ 111 : Reserved Note : Let (Too Cold) < (Cold) < (Hot) < (Too Hot)							
	BAT_NEG	Battery negative status bit 0 : Normal 1 : BAT pin is negative voltage							
	TS_fault	TS_fault 0 : Normal 1 : Too Cold or Too Hot							

I²C_CTR1

Address	Name	Bit7	Bit6	Bit5	Bit4	Bit3	Bit2	Bit1	Bit0
0x05	CTR1	VREG						JA_CV1	JA_CV0
	Reset Value	1	0	0	0	1	1	0	1
	Read/Write	R/W	R/W	R/W	R/W	R/W	R/W	R/W	R/W
	VREG	Setting of Battery Regulation Voltage (Range : 3.5V to 4.26V, Default = 4.2V) If Auto_JA = 1, these bits will not control.							
		000000	3.50V	010000	3.82V	100000	4.14V	110000	4.26V
		000001	3.52V	010001	3.84V	100001	4.16V	110001	4.26V
		000010	3.54V	010010	3.86V	100010	4.18V	110010	4.26V
		000011	3.56V	010011	3.88V	100011	4.20V	110011	4.26V
		000100	3.58V	010100	3.90V	100100	4.22V	110100	4.26V
		000101	3.60V	010101	3.92V	100101	4.24V	110101	4.26V
		000110	3.62V	010110	3.94V	100110	4.26V	110110	4.26V
		000111	3.64V	010111	3.96V	100111	4.26V	110111	4.26V
		001000	3.66V	011000	3.98V	101000	4.26V	111000	4.26V
		001001	3.68V	011001	4.00V	101001	4.26V	111001	4.26V
		001010	3.70V	011010	4.02V	101010	4.26V	111010	4.26V
		001011	3.72V	011011	4.04V	101011	4.26V	111011	4.26V
		001100	3.74V	011100	4.06V	101100	4.26V	111100	4.26V
		001101	3.76V	011101	4.08V	101101	4.26V	111101	4.26V
		001110	3.78V	011110	4.10V	101110	4.26V	111110	4.26V
		001111	3.80V	011111	4.12V	101111	4.26V	111111	4.26V
	JA_CV1	If Auto_JA = 1, JA_CV1 controls charge voltage, Hot ~ Too Hot 0 : Hot ~ Too Hot : 4.06V 1 : Hot ~ Too Hot : 4.2V							
	JA_CV0	If Auto_JA = 1, JA_CV0 controls charge voltage, Cold ~ Too Cold 0 : Cold ~ Too Cold : 4.06V 1 : Cold ~ Too Cold : 4.2V							

I²C_CTR2

Address	Name	Bit7	Bit6	Bit5	Bit4	Bit3	Bit2	Bit1	Bit0
0x06	CTR2	ICHG				IPRE_CHG		JA_CC1	JA_CC0
	Reset Value	0	0	0	0	0	0	1	0
	Read/Write	R/W	R/W	R/W	R/W	R/W	R/W	R/W	R/W
ICHG	Setting of Fast Charge Current (Range : 66mA to 1000mA, Default = 66mA)								
	0000	66mA							
	0001	100mA							
	0010	200mA							
	0011	250mA							
	0100	300mA							
	0101	350mA							
	0110	400mA							
	0111	450mA							
	1000	500mA							
	1001	600mA							
	1010	700mA							
	1011	800mA							
	1100	900mA							
	1101	1000mA							
1110	1100mA								
1111	1200mA								
IPre_CHG	Setting of Pre-charge Current (Range : 40 to 100mA, Default = 40mA)								
	00	40mA							
	01	60mA							
	10	80mA							
	11	100mA							
JA_CC1	If Auto_JA = 1, JA_CC1 controls the current , Hot ~ Too Hot 0 : Hot ~ Too Hot : 50% charge current 1 : Hot ~ Too Hot : 100% charge current								
JA_CC0	If Auto_JA = 1, JA_CC0 controls the current , Cold ~ Too Cold 0 : Cold ~ Too Cold : 50% charge current 1 : Cold ~ Too Cold : 100% charge current								

I²C_CTR3

Address	Name	Bit7	Bit6	Bit5	Bit4	Bit3	Bit2	Bit1	Bit0	
0x07	CTR3	Itermi			VPRE			Time_out		
	Reset Value	0	0	1	1	1	0	0	0	
	Read/Write	R/W	R/W	R/W	R/W	R/W	R/W	R/W	R/W	
Itermi		Setting of charger termination Ratio (Range : 5 to 35%, Default = 10%)								
		000	5%							
		001	10%							
		010	15%							
		011	20%							
		100	25%							
		101	35%							
		110	Reserved							
VPre to Fast		Setting of Pre to Fast charge (Range : 2.4 to 3.1V, Default = 3V)								
		000	2.4V							
		001	2.5V							
		010	2.6V							
		011	2.7V							
		100	2.8V							
		101	2.9V							
		110	3.0V							
Time-out		Setting of Time out Pre/Fast (Range : 30min/240min to 60min/480min, Default = 30min/240min)								
		00	Pre / Fast = 30min / 240min							
		01	Pre / Fast= 45min / 360min							
		10	Pre / Fast = 60min / 480min							
		11	Disable							

I²C_CTR4

Address	Name	Bit7	Bit6	Bit5	Bit4	Bit3	Bit2	Bit1	Bit0
0x08	CTR4	RNTC Type		Too Cold			Cold		
	Reset Value	0	0	1	0	0	1	0	0
	Read/Write	R/W	R/W	R/W	R/W	R/W	R/W	R/W	R/W
	RNTC Type	RNTC Type set 00 : See SETNTC Pin 01 : RNTC = 100kΩ 10 : RNTC = 10kΩ 11 : Reserved(same as 00)							
	Too Cold	Setting of charger Too Cold Temperature (Range : -10 to 15°C, Default = 0°C) 000 : -10°C 001 : -10°C 010 : -10°C 011 : -5°C 100 : 0°C 101 : 5°C 110 : 10°C 111 : 15°C							
	Cold	Setting of charger Cold Temperature (Range : -10 to 25°C, Default = 10°C) 000 : -10°C 001 : -5°C 010 : 0°C 011 : 5°C 100 : 10°C 101 : 15°C 110 : 20°C 111 : 25°C							

I²C_CTR5

Address	Name	Bit7	Bit6	Bit5	Bit4	Bit3	Bit2	Bit1	Bit0
0x09	CTR5	CHG_IND_DIS	I ² C_ctl	Hot			Too Hot		
	Reset Value	0	0	1	0	0	1	0	0
	Read/Write	R/W	R/W	R/W	R/W	R/W	R/W	R/W	R/W
	CHG_IND_DIS	CHG pin control : 0 : CHG pin is normal. (Default) 1 : $\overline{\text{CHG}}$ pin is high impedance							
	I ² C_ctl	When VIN is no power force RT9528 wake-up. 0 : Disable 1 : Enable							
	Hot	Setting of charger Hot Temperature (Range : 25 to 58°C, Default = 45°C) 000 : 25°C 001 : 30°C 010 : 35°C 011 : 40°C 100 : 45°C 101 : 50°C 110 : 55°C 111 : 58°C							
	Too Hot	Setting of charger Too Hot Temperature (Range : 40 to 58°C, Default = 58°C) 000 : 40°C 001 : 45°C 010 : 50°C 011 : 55°C 100 : 58°C 101 : 58°C 110 : 58°C 111 : 58°C							

Base_SET3

Address	Name	Bit7	Bit6	Bit5	Bit4	Bit3	Bit2	Bit1	Bit0
0x0a	Base_SET3	COMP		COMN		CP_EN	CP_AUD	CHG_TYP	USB_CHGDET
	Reset Value	1	1	1	1	0	0	0	1
	Read/Write	R/W	R/W	R/W	R/W	R/W	R/W	R/W	R/W
	COMP	The bit sets the position of the mux switch connected to COMP 00 : COMP Connected to DP 01 : COMP Connected to AUDIO2 10 : High Impedance 11 : High Impedance							
	COMN	The bit sets the position of the mux switch connected to COMN 00 : COMN Connected to DN 01 : COMN Connected to AUDIO1 10 : High Impedance 11 : High Impedance							
	CP_EN	Enables the charge pump required for analog switch operation. Set to 1 when any signal is passed through the switch. When set to disable, there must be no signal connected to an audio input which goes below ground. 0 : Disabled 1 : Enabled							
	CP_AUD	The bit sets the position of the click/pop resistor on both AUDIO1 and AUDIO2 0 : Disabled 1 : Enabled							
	CHG_TYP	Enables Charger Type Detection. Set this bit to determine between Dedicated USB charger and High Current Host/Hub Chargers. 0 : Disabled 1 : Enabled							
	USB_CHGDET	Enables the USB Charger Detection. 0 : Disabled 1 : Enabled							

Application Information

J_A Initial State

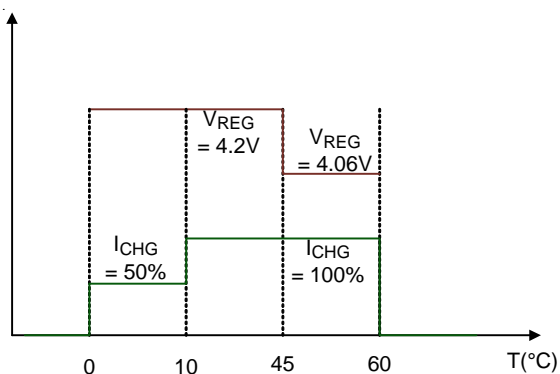

VDET

If VIN power is good, 0x02 VDET_status works normally.
 If Only Battery plugs in, 0x02 VDET_status = 1

WKUP

WKUP keeps Hi-Z without VIN.

Interrupt Chart flow

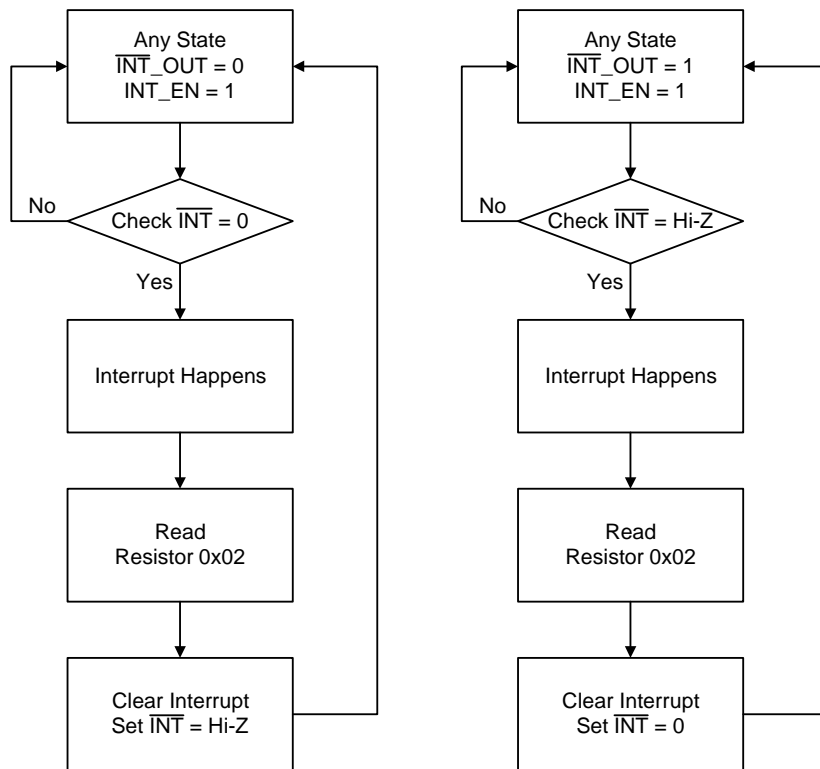

Note 1 :

If Set INT_EN = 0, it just mask the INT signal.
 When INT_EN = 1, interrupt still happens.

Note 2 :

If INT_OUT = 0 and INT_EN = 0, INT pin is high impedance.
 If INT_OUT = 1 and INT_EN = 0, INT pin is low.

Charger Initial Flow Chart

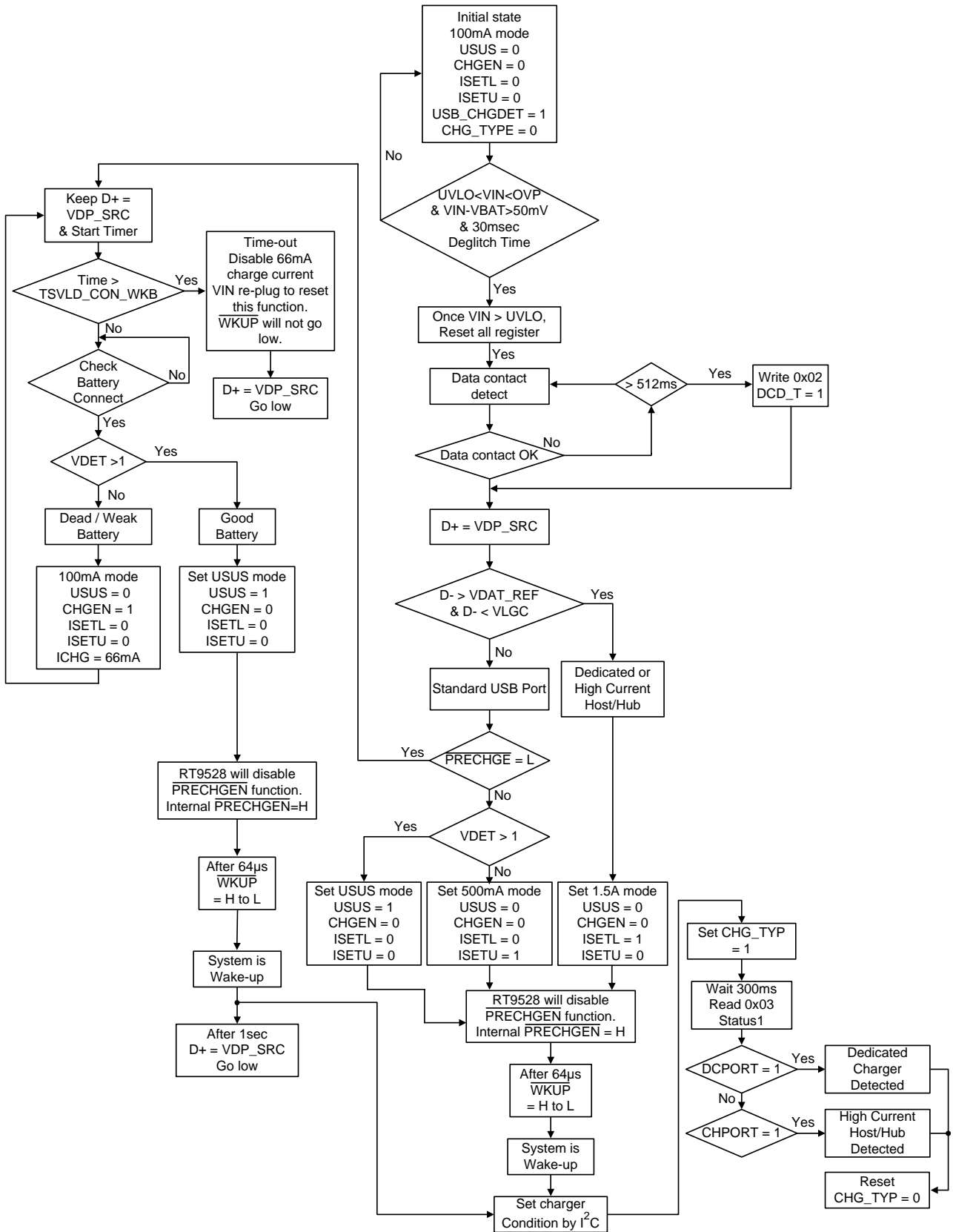

After WKUP from H go L, system can do DCD and CHGDET again as below

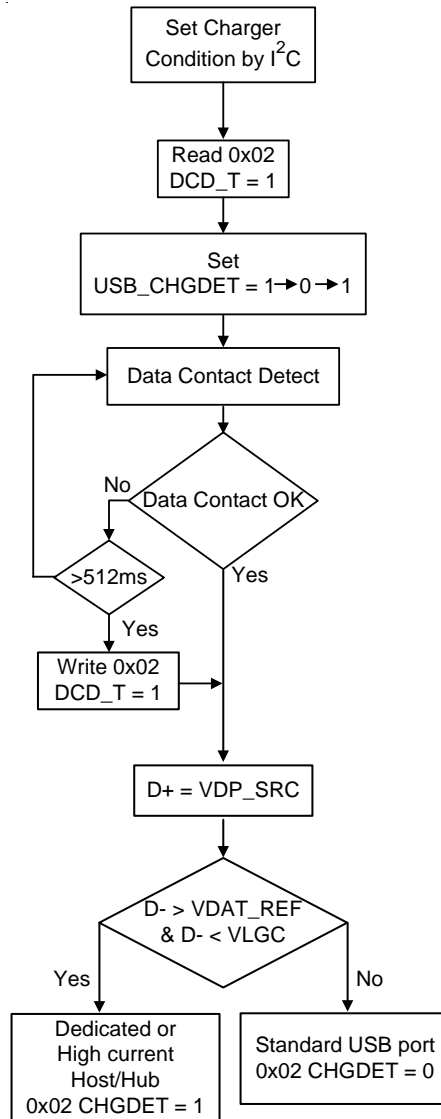

NTC Ratio

NCP15WF104F03RC_100kΩ

T (°C)	R1 (kΩ)	RNTC (kΩ)	Ratio (%)
-10	100	528.988	84
-5	100	471.632	82.5
0	100	357.012	78
5	100	272.5	73
10	100	209.71	67.5
15	100	162.651	62
20	100	127.08	56
25	100	100	50
30	100	79.222	44
35	100	63.167	38.5
40	100	50.677	33.5
45	100	40.904	29
50	100	33.195	25
55	100	27.091	21.5
58	100	24.1708	19.5

NCP15XH103F03RC_10kΩ

T (°C)	R1 (kΩ)	RNTC (kΩ)	Ratio (%)
-10	10	42.5062	81
-5	10	33.8922	77
0	10	27.2186	73
5	10	22.0211	69
10	10	17.9255	64
15	10	14.6735	59.5
20	10	12.0805	54.5
25	10	10	50
30	10	8.3145	45.5
35	10	6.9479	41
40	10	5.8336	37
45	10	4.9169	33
50	10	4.1609	29.5
55	10	3.535	26
58	10	3.22258	24.5

I²C Write and Read

Write

RT9528 1 support byte writing as below. If you want to write another data byte, you must follow as below again.

- Writing 1 Byte of Data to RT

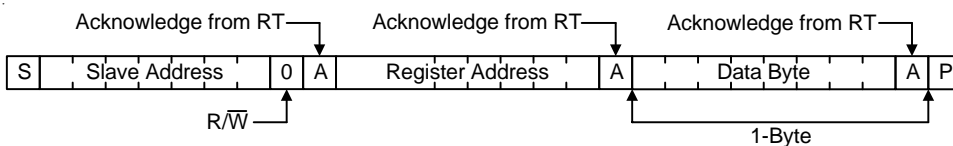

Read

RT9528 1 support byte reading as below. If you want to read another data byte, you must follow as below again.

- Reading 1 Byte of Data from RT

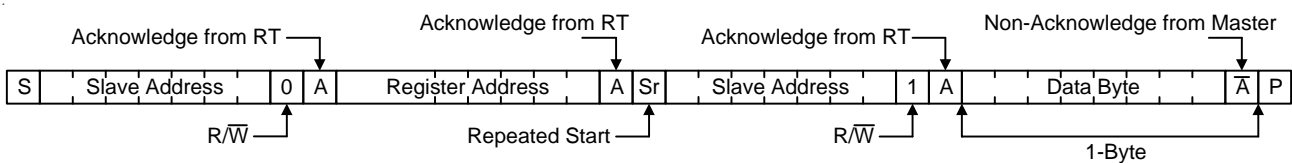

$\overline{\text{INT}}$ Release

- $\overline{\text{INT}}$ release, $\overline{\text{INT_OUT}} = 0$ and $\text{INT_EN} = 1$

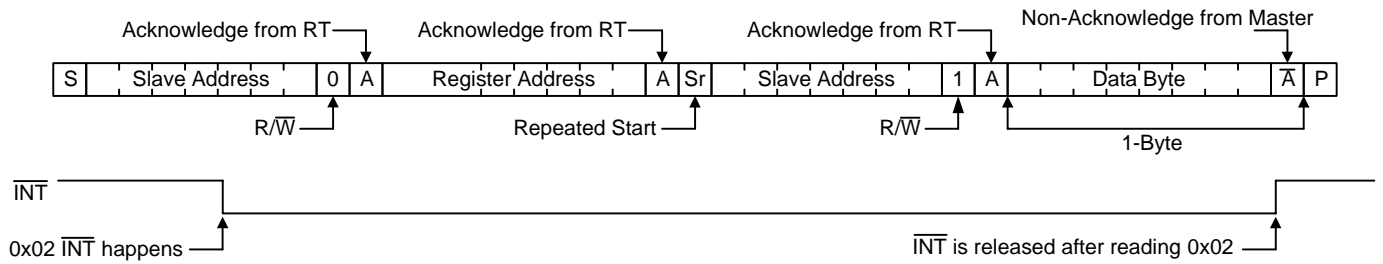

Data Pin Contact Timing

DCD Timing, Contact After Start

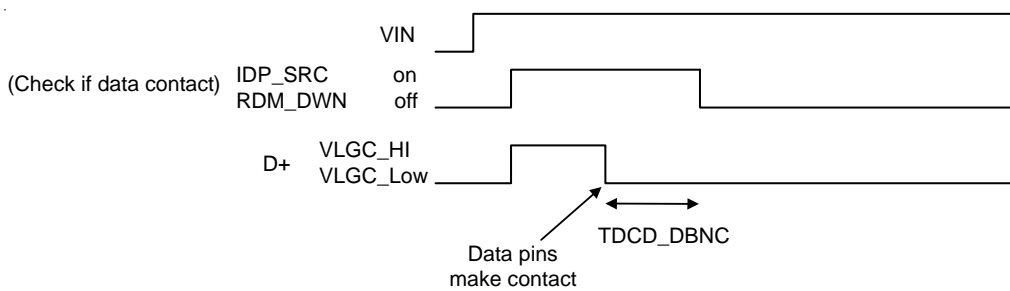

DCD Timing, Contact Before Start

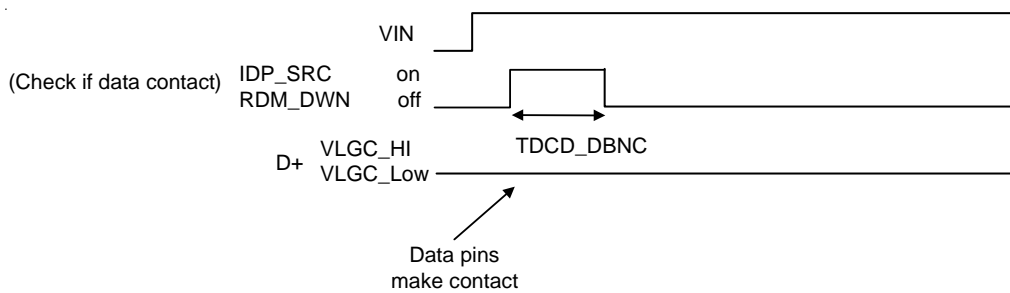

DCD Timing, non Contact

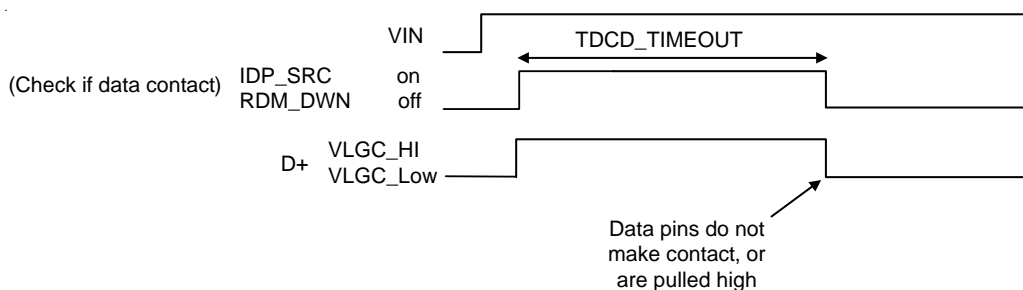

Waveform for PRECHGEN

PRECHGEN = H

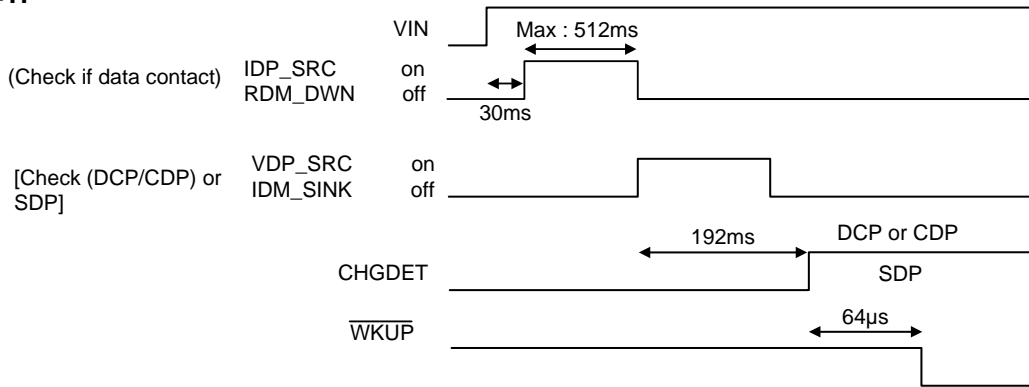

SDP : Standard Downstream Port
 CDP : Charging Downstream Port
 DCP : Dedicated Charging Port

PRECHGEN = L

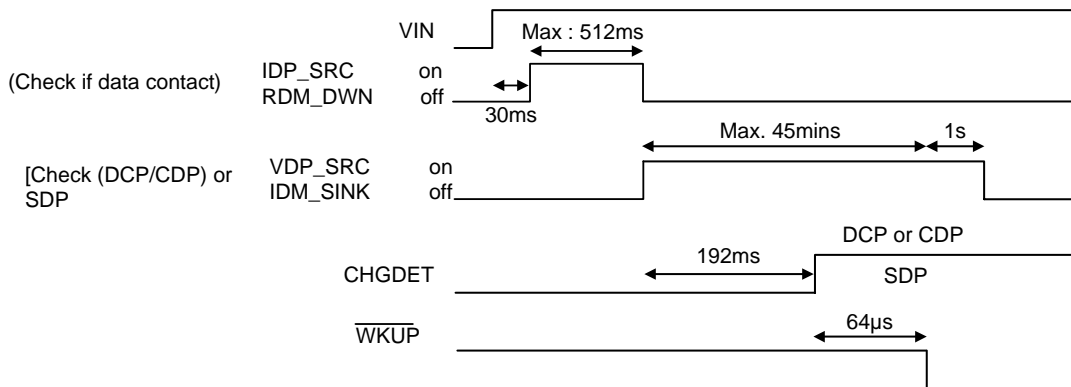

SDP : Standard Downstream Port
 CDP : Charging Downstream Port
 DCP : Dedicated Charging Port

ISET

For dead battery flow or pre-charge flow, charge current will not be half, even if 0x01 ISET = 0.

For fast charge flow, if ISET = 1, charge current = 1 x (I²C set); if ISET = 0, charge current = 0.5 x (I²C set).

Time-Out

(1) For dead battery flow : (regardless of Auto-JA)

If 0x01 ISET = 1 (default)

Timeout = 30min, even if too cold or too hot.

If 0x01 ISET = 0

Timeout = 30min, even if too cold or too hot.

During the timeout period, the $\overline{\text{CHG}}$ pin is high impedance.

(2) For pre-charge flow : (regardless of Auto-JA)

If 0x01 ISET = 1 (default)

Timeout = 1 x (I²C set), even if too cold or too hot.

If 0x01 ISET = 0

Timeout = 1 x (I²C set), even if too cold or too hot.

During the timeout period, the $\overline{\text{CHG}}$ pin is flashed by 2Hz.

(3) For fast-charge flow :

(3_1) 0x01 Auto-JA = 0

If 0x01 ISET = 1 (default)

Timeout = 1 x (I²C set), even if too cold or too hot.

If 0x01 ISET = 0

Timeout = 2 x (I²C set), even if too cold or too hot.

(3_2) 0x01 Auto-JA = 1

The charge current is set according to 0x06 JA_CC1 and JA_CC0 setting.

If Auto-JA makes charge current to be half for cold or hot condition, Timeout = 2 x (I²C set), and timeout will be still the same (= 2 x (I²C set)) if too cold or too hot.

During the timeout period, the $\overline{\text{CHG}}$ pin is flashed by 2Hz.

$\overline{\text{CHG}}$ Indicator

In dead battery or normal charge flow, the following cases make the $\overline{\text{CHG}}$ pin to be high impedance : no battery, too hot too cold, 0x00 USUS = 1, 0x00 CHG_EN = 0, charge termination, time-out in dead battery flow, 0x09 CHG_IND_DIS = 1, or 0x02 PG2 = 0 in normal charge flow.

Battery absent function and TS function

If VIN plugs in, 0x01 TS = 1 and 0x01 LDO_TS = 1, battery absent function and TS function will work normally.

If only battery plugs in, battery absent function and TS function will not work due to battery leakage current request (IBAT < 5μA). And 0x02 Battery absent = 1 even if battery plugs in. 0x04 TS_flag [bit7, bit6, bit5] = [010] even if battery temperature changes. If you need battery absent function and TS function, you can set 0x09 I²C_ctl = 1, VEXT pin > 3.8V, 0x01 TS = 1, and 0x01 LDO_TS = 1. However, these functions will sink current from battery. If you want to suspend battery current, you can set 0x09 I²C_ctl = 0 and VEXT pin = 0V.

By the way, if VIN and battery plug in and 0x02 USUS = 1 or CHG_EN = 0, the 0x04 TS_fault bit will be set at 1. After setting USUS = 0 and CHG_EN = 1, the 0x04 TS_fault bit can work normally. When 0x09 I²C_ctl = 1, the 0x04 TS_fault bit will work normally even if USUS = 1 or CHG_EN = 0.

Upside Down Battery Function

If battery is inserted upside down, it causes that the voltage of BAT pin is negative. RT9528 will disable charger function until battery voltage is normal. If battery is inserted upside down, 0x04 bit4 BAT_NEG will be 1.

USB Switch

If VIN is not good power (VIN > OVP, VIN < UNLO, or VIN-VBA < 50mV), USB switch will be turned off even if set 0x0a COMP = (0,0) COMN = (0,0).

I²C Register Reset

If VIN plugs in, all I²C register will reset.

Thermal Considerations

For continuous operation, do not exceed absolute maximum junction temperature. The maximum power dissipation depends on the thermal resistance of the IC package, PCB layout, rate of surrounding airflow, and difference between junction and ambient temperature. The maximum power dissipation can be calculated by the following formula :

$$P_{D(MAX)} = (T_{J(MAX)} - T_A) / \theta_{JA}$$

where T_{J(MAX)} is the maximum junction temperature, T_A is the ambient temperature, and θ_{JA} is the junction to ambient thermal resistance.

For recommended operating condition specifications, the maximum junction temperature is 125°C. The junction to ambient thermal resistance, θ_{JA}, is layout dependent. For WQFN-28L 4x4 package, the thermal resistance, θ_{JA}, is 52°C/W on a standard JEDEC 51-7 four-layer thermal test board. The maximum power dissipation at T_A = 25°C can be calculated by the following formula :

$$P_{D(MAX)} = (125^\circ\text{C} - 25^\circ\text{C}) / (52^\circ\text{C/W}) = 1.923\text{W for}$$

WQFN-28L 4x4 package

The maximum power dissipation depends on the operating ambient temperature for fixed T_{J(MAX)} and thermal resistance, θ_{JA}. The derating curve in Figure 1 allows the designer to see the effect of rising ambient temperature on the maximum power dissipation.

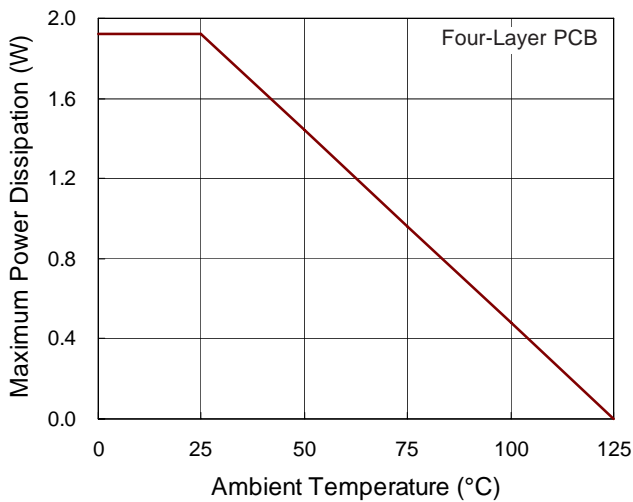

Figure 1. Derating Curve of Maximum Power Dissipation

Layout Considerations

The RT9528 is a fully integrated low cost single cell Li-ion battery charger ideal for portable applications. Careful PCB layout is necessary. For best performance, place all peripheral components as close to the IC as possible. A short connection is highly recommended. The following guidelines should be strictly followed when designing a PCB layout for the RT9528.

- ▶ Input and output capacitor should be placed as close to the IC as possible and connected to ground plane. The input trace on the PCB should be placed far away from sensitive devices and shielded by the ground.
- ▶ The GND and exposed pad should be connected to a strong ground plane for heat sinking and noise protection.
- ▶ DN pin and DP pin should be placed as close to the USB controller as possible. Distance of the DN/DP pin to USB controller must be less than 25mm. A short wire is recommended to prevent EMI and noise coupling.
- ▶ The trace of DN pin and DP pin avoids using via for low impedance of the transmission line.
- ▶ The trace of DN pin and DP pin is as symmetrical as possible to improve performance.
- ▶ The trace of USB function avoids using cross line for noise coupling.

Outline Dimension

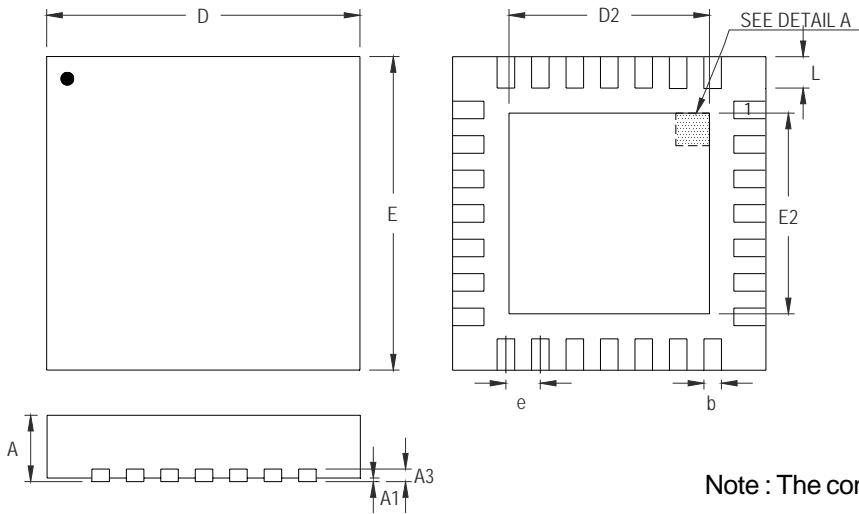

DETAIL A

Pin #1 ID and Tie Bar Mark Options

Note : The configuration of the Pin #1 identifier is optional, but must be located within the zone indicated.

Symbol	Dimensions In Millimeters		Dimensions In Inches	
	Min	Max	Min	Max
A	0.700	0.800	0.028	0.031
A1	0.000	0.050	0.000	0.002
A3	0.175	0.250	0.007	0.010
b	0.150	0.250	0.006	0.010
D	3.900	4.100	0.154	0.161
D2	2.350	2.450	0.093	0.096
E	3.900	4.100	0.154	0.161
E2	2.350	2.450	0.093	0.096
e	0.400		0.016	
L	0.350	0.450	0.014	0.018

W-Type 28L QFN 4x4 Package

Richtek Technology Corporation

5F, No. 20, Taiyuen Street, Chupei City
 Hsinchu, Taiwan, R.O.C.
 Tel: (8863)5526789

Richtek products are sold by description only. Richtek reserves the right to change the circuitry and/or specifications without notice at any time. Customers should obtain the latest relevant information and data sheets before placing orders and should verify that such information is current and complete. Richtek cannot assume responsibility for use of any circuitry other than circuitry entirely embodied in a Richtek product. Information furnished by Richtek is believed to be accurate and reliable. However, no responsibility is assumed by Richtek or its subsidiaries for its use; nor for any infringements of patents or other rights of third parties which may result from its use. No license is granted by implication or otherwise under any patent or patent rights of Richtek or its subsidiaries.

单击下面可查看定价，库存，交付和生命周期等信息

[>>Richtek\(台湾立锜\)](#)