

## Rail-to-Rail Operational Amplifier

### General Description

The RT9133A/B consist low cost, high slew rates, single-supply rail-to-rail input and output operation amplifiers. The RT9133A contains a single amplifier and RT9133B contains two amplifiers. The RT9133A/B have high slew rates (12V/us), 35mA continuous output current, 120mA peak output current and offset voltage below 10mV. The RT9133A/B are ideal for Thin Film Transistor Liquid Crystal Displays (TFT-LCD).

The RT9133A is available in SOT-23-5 and WDFN-6L 2x2 packages. The RT9133B is available in MSOP-8 package. The RT9133A/B are specified for operation over the full -40°C to +85°C temperature range.

### Ordering Information

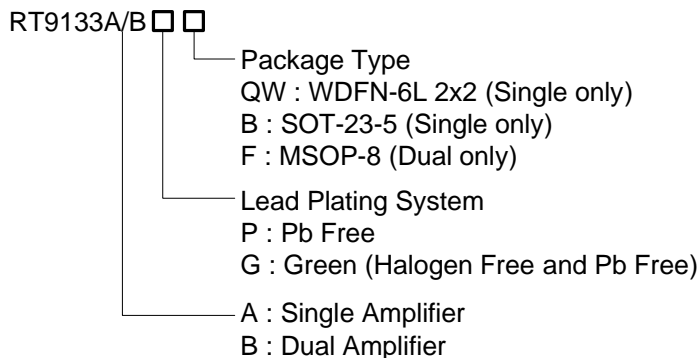

Note :

Richtek products are :

- ▶ RoHS compliant and compatible with the current requirements of IPC/JEDEC J-STD-020.
- ▶ Suitable for use in SnPb or Pb-free soldering processes.

### Marking Information

For marking information, contact our sales representative directly or through a Richtek distributor located in your area.

### Features

- Rail-to-Rail Output Swing
- Supply Voltage : 4.5V to 15V
- Continuous Output Current : 35mA
- Peak Output Current : 120mA
- High Slew Rate : 12V/us
- Offset Voltage : 10mV
- RoHS Compliant and 100% Lead (Pb)-Free

### Applications

- TFT-LCD Gamma / V<sub>COM</sub> Buffer
- Portable Electronic Product
- Communications Product

### Pin Configurations

(TOP VIEW)

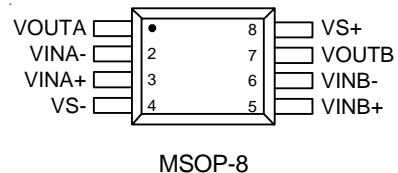
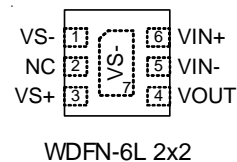
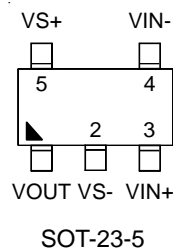

## Function Block Diagram

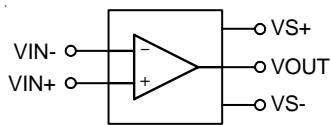

**RT9133A**

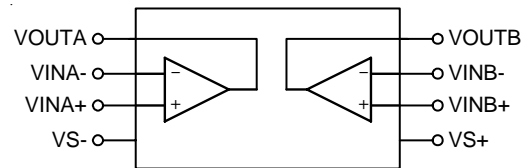

**RT9133B**

## Functional Pin Description

### Single

Pin No.		Pin Name	Pin Function
SOT-23-5	WDFN-6L 2x2		
1	4	VOUT	Amplifier Output.
--	2	NC	No Internal Connection.
2	1, 7 (Exposed Pad)	VS-	Negative Power Supply.
3	6	VIN+	Amplifier Non-Inverting Input.
4	5	VIN-	Amplifier Inverting Input.
5	3	VS+	Positive Power Supply.

### Dual

Pin No.	Pin Name	Pin Function
1	VOUTA	Amplifier A Output.
2	VINA-	Amplifier A Inverting Input.
3	VINA+	Amplifier A Non-Inverting Input.
4	VS-	Negative Power Supply.
5	VINB+	Amplifier B Non-Inverting Input.
6	VINB-	Amplifier B Inverting Input.
7	VOUTB	Amplifier B Output.
8	VS+	Positive Power Supply.

**Absolute Maximum Ratings** (Note 1)

- Supply Voltage ----- 17V
- Power Dissipation,  $P_D$  @  $T_A = 25^\circ\text{C}$ 
  - SOT-23-5 ----- 500mW
  - WDFN-6L 2x2 ----- 758mW
  - MSOP-8 ----- 781mW
- Package Thermal Resistance (Note 2)
  - SOT-23-5,  $\theta_{JA}$  -----  $250^\circ\text{C/W}$
  - WDFN-6L 2x2,  $\theta_{JA}$  -----  $165^\circ\text{C/W}$
  - MSOP-8,  $\theta_{JA}$  -----  $160^\circ\text{C/W}$
- Differential Input Voltage -----  $V_S$
- Lead Temperature (Soldering, 10 sec.) -----  $260^\circ\text{C}$
- Storage Temperature Range -----  $-65^\circ\text{C}$  to  $+150^\circ\text{C}$
- ESD Susceptibility (Note 3)
  - HBM (Human Body Mode) ----- 2kV
  - MM (Machine Mode) ----- 200V

**Recommended Operating Conditions** (Note 4)

- Input Voltage -----  $-0.5\text{V}$  to  $V_S+0.5\text{V}$
- Junction Temperature Range -----  $-65^\circ\text{C}$  to  $+150^\circ\text{C}$
- Ambient Temperature Range -----  $-40^\circ\text{C}$  to  $+85^\circ\text{C}$

**Note 1.** Stresses listed as the above “Absolute Maximum Ratings” may cause permanent damage to the device. These are for stress ratings. Functional operation of the device at these or any other conditions beyond those indicated in the operational sections of the specifications is not implied. Exposure to absolute maximum rating conditions for extended periods may remain possibility to affect device reliability.

**Note 2.**  $\theta_{JA}$  is measured in the natural convection at  $T_A = 25^\circ\text{C}$  on a low effective thermal conductivity test board (single layer, 1S) of JEDEC 51-3 thermal measurement standard.

**Note 3.** Devices are ESD sensitive. Handling precaution is recommended.

**Note 4.** The device is not guaranteed to function outside its operating conditions.

**Electrical Characteristics**

( $V_S = \pm 5V$ ,  $V_S = -5V$ ,  $R_L = 10k\Omega$  and  $C_L = 10pF$  to  $0V$ ,  $T_A = 25^\circ C$ , unless otherwise specified)

Parameter	Symbol	Test Conditions	Min	Typ	Max	Unit
<b>Input Characteristics</b>						
Input Offset Voltage	$V_{OS}$	$V_{CM} = 0$	--	2	15	mV
Average Offset Voltage Drift	$\Delta V_{OS}/\Delta T$	$-40^\circ C \leq T_A \leq 85^\circ C$	--	5	--	$\mu V/^\circ C$
Input Bias Current	$I_B$	$V_{CM} = 0$	--	2	50	nA
Input Impedance	$R_{IN}$		--	1	--	$G\Omega$
Input Capacitance	$C_{IN}$		--	1.35	--	pF
Common-Mode Input Range	CMIR		-5.5	--	+5.5	V
Common-Mode Rejection Ratio	CMRR	For $V_{IN}$ from $-5.5V$ to $+5.5V$	50	80	--	dB
Open-Loop Gain	$A_{VOL}$	$-4.5V \leq V_{OUT} \leq +4.5V$	75	95	--	dB
<b>Output Characteristics</b>						
Output swing Low	$V_{OL}$	$I_L = -5mA$	--	-4.92	-4.85	V
Output swing High	$V_{OH}$	$I_L = +5mA$	4.85	4.92	--	V
Continuous $V_{COM}$ Buffer Output current	$I_{OC}$		--	$\pm 35$	--	mA
Peak $V_{COM}$ Buffer Output current	$I_{PC}$		--	$\pm 120$	--	mA
<b>Power Supply</b>						
Supply Voltage	$V_S$		4.5	--	15	V
Power Supply Rejection Ratio	PSRR	$V_S$ is moved from $\pm 2.25V$ to $\pm 7.75V$	60	70	--	dB
Supply Current/Amplifier	$I_{SY}$	No Load	--	500	750	$\mu A$
<b>Dynamic Performance</b>						
Slew Rate(Note)	SR	$-4.0V \leq V_{OUT} \leq +4.0V$ , 20% to 80%	--	12	--	V/ $\mu s$
Setting to $\pm 0.1\%$ ( $A_V = +1$ )	$t_S$	( $A_V = +1$ ), $V_{OUT} = 2V$ step	--	500	--	ns
-3dB Bandwidth	BW	$R_L = 10k\Omega$ , $C_L = 10 pF$	--	12	--	MHz
Gain-Bandwidth Product	GBWP	$R_L = 10k\Omega$ , $C_L = 10 pF$	--	5	--	MHz
Phase Margin	PM	$R_L = 10k\Omega$ , $C_L = 10 pF$	--	50	--	$^\circ$
Channel Separation	CS	$f = 5MHz$	--	75	--	dB

Note: Slew rate is measured on rising and falling edges.

( $V_{S+}=+2.5V$ ,  $V_{S-} = -2.5V$ ,  $R_L = 10k\Omega$  and  $C_L = 10pF$  to 2.5V,  $T_A = 25^\circ C$ , unless otherwise specified)

Parameter	Symbol	Test Conditions	Min	Typ	Max	Unit
<b>Input Characteristics</b>						
Input Offset Voltage	$V_{OS}$	$V_{CM} = 2.5V$	--	2	15	mV
Average Offset Voltage Drift	$\Delta V_{OS}/\Delta T$	$-40^\circ C \leq T_A \leq 85^\circ C$	--	5	--	$\mu V/^\circ C$
Input Bias Current	$I_B$	$V_{CM} = 2.5V$	--	2	50	nA
Input Impedance	$R_{IN}$		--	1	--	$G\Omega$
Input Capacitance	$C_{IN}$		--	1.35	--	pF
Common-Mode Input Range	CMIR		-0.5	--	+5.5	V
Common-Mode Rejection Ratio	CMRR	For $V_{IN}$ from -0.5V to +5.5V	45	65	--	dB
Open-Loop Gain	$A_{VOL}$	$0.5V \leq V_{OUT} \leq +4.5V$	75	95	--	dB
<b>Output Characteristics</b>						
Output swing Low	$V_{OL}$	$I_L = -5mA$	--	-2.42	-2.35	mV
Output swing High	$V_{OH}$	$I_L = +5mA$	2.35	2.42	--	V
Continuous $V_{COM}$ Buffer Output current	$I_{OC}$		--	$\pm 35$	--	mA
Peak $V_{COM}$ Buffer Output current	$I_{PC}$		--	$\pm 90$	--	mA
<b>Power Supply</b>						
Power Supply Rejection Ratio	PSRR	$V_S$ is moved from $\pm 2.25V$ to $\pm 7.75V$	45	70	--	dB
Supply Current/Amplifier	$I_{SY}$	No Load	--	500	750	$\mu A$
<b>Dynamic Performance</b>						
Slew Rate(Note)	SR	$-4V \leq V_{OUT} \leq +4V$ , 20% to 80%	--	12	--	V/ $\mu s$
Setting to $\pm 0.1\%$ ( $A_V = +1$ )	$t_s$	( $A_V = +1$ ), $V_{OUT} = 2V$ step	--	500	--	ns
-3dB Bandwidth	BW	$R_L = 10k\Omega$ , $C_L = 10 pF$	--	12	--	MHz
Gain-Bandwidth Product	GBWP	$R_L = 10k\Omega$ , $C_L = 10 pF$	--	5	--	MHz
Phase Margin	PM	$R_L = 10k\Omega$ , $C_L = 10 pF$	--	50	--	$^\circ$
Channel Separation	CS	$f = 5MHz$	--	75	--	dB

Note: Slew rate is measured on rising and falling edges.

Typical Operating Characteristics

Quiescent Current vs. Supply Voltage

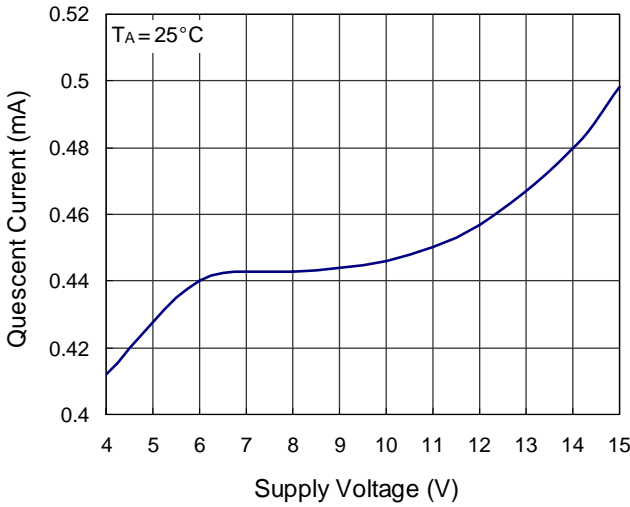

Quiescent current vs. Temperature

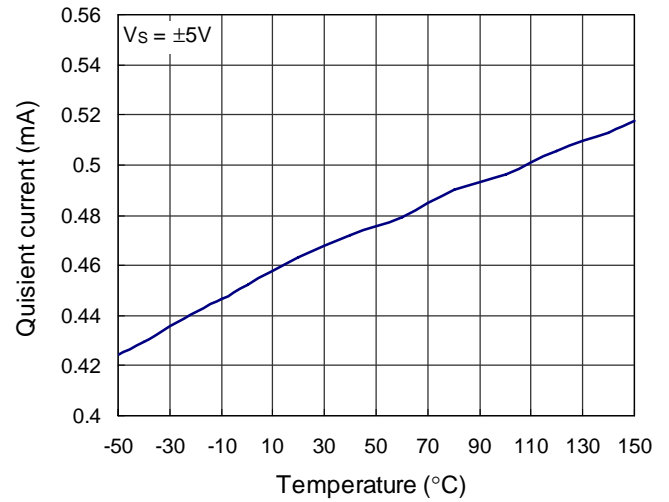

Output High Voltage vs. Temperature

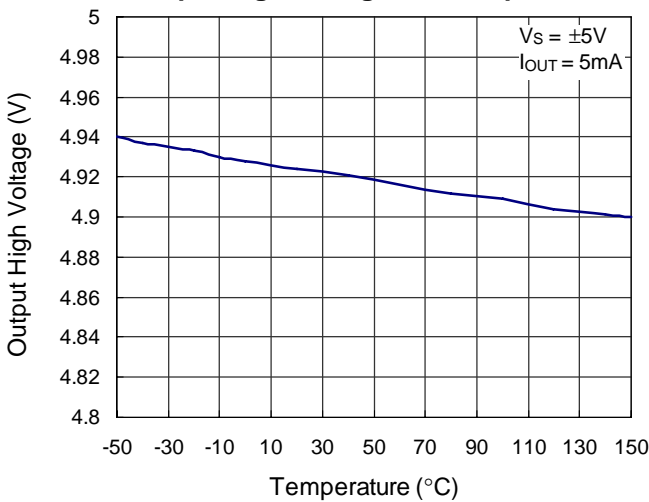

Output Low Voltage vs. Temperature

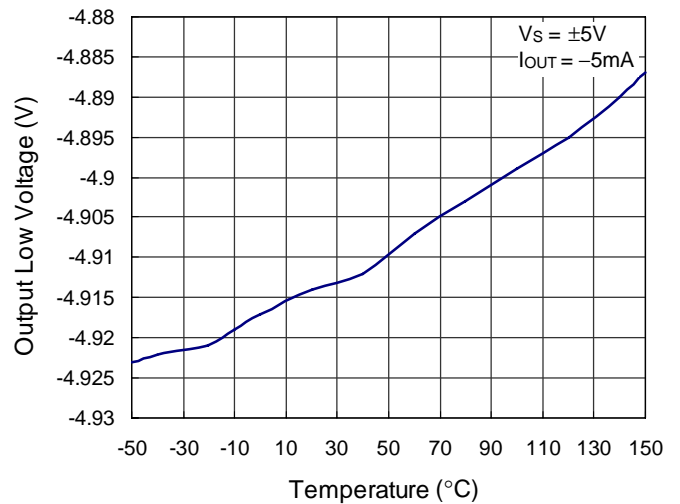

Slew Rate vs. Temperature

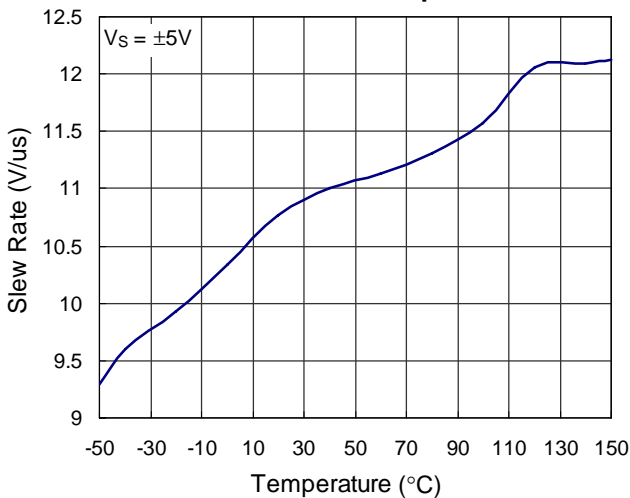

Frequency Response for Various RL

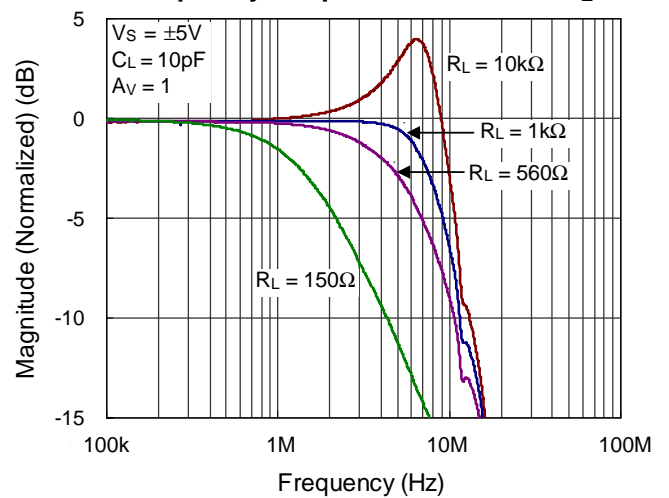

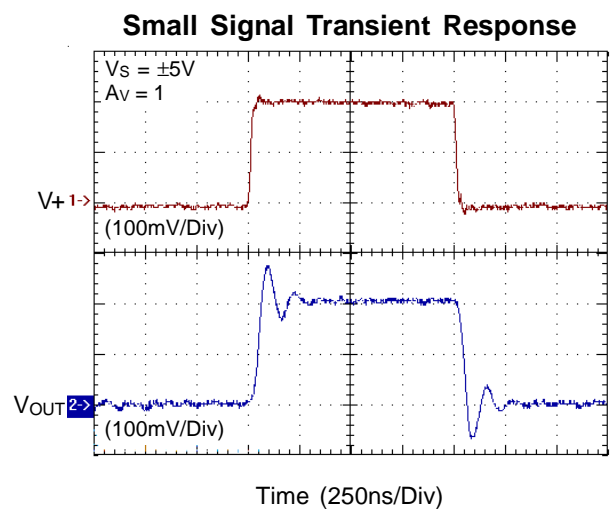
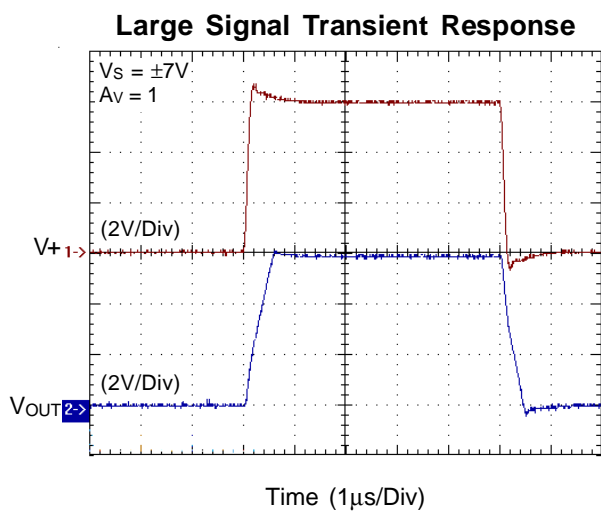
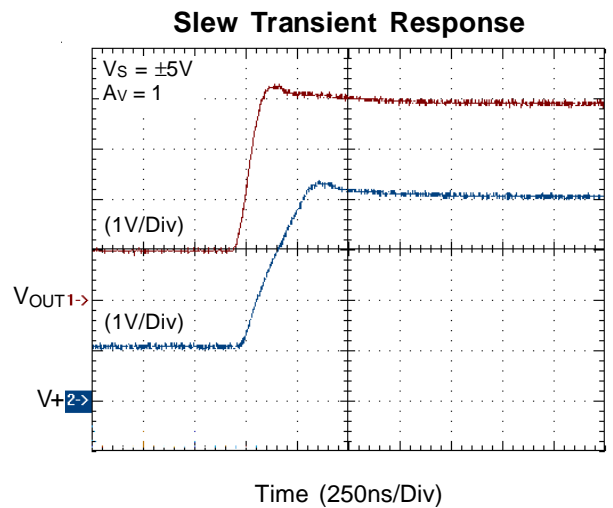
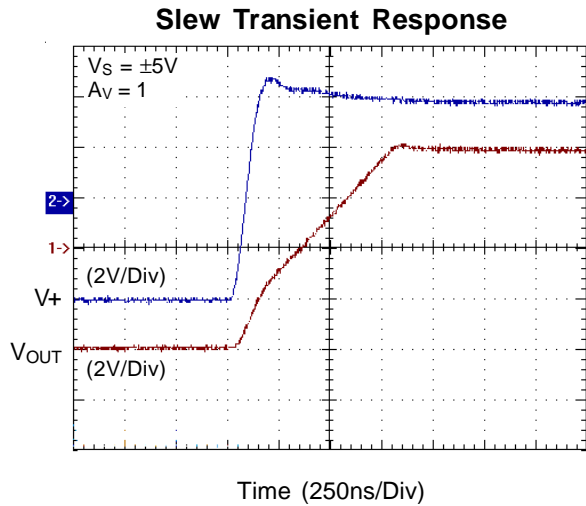
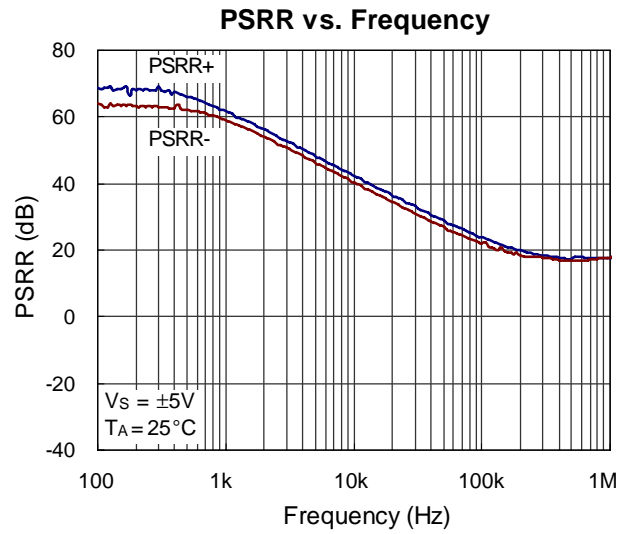
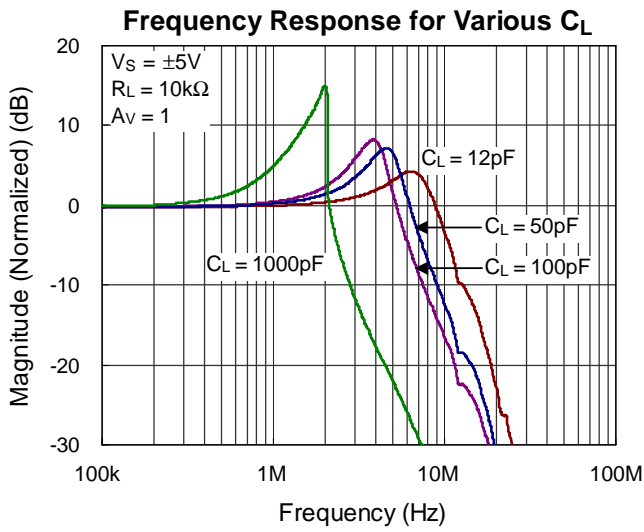

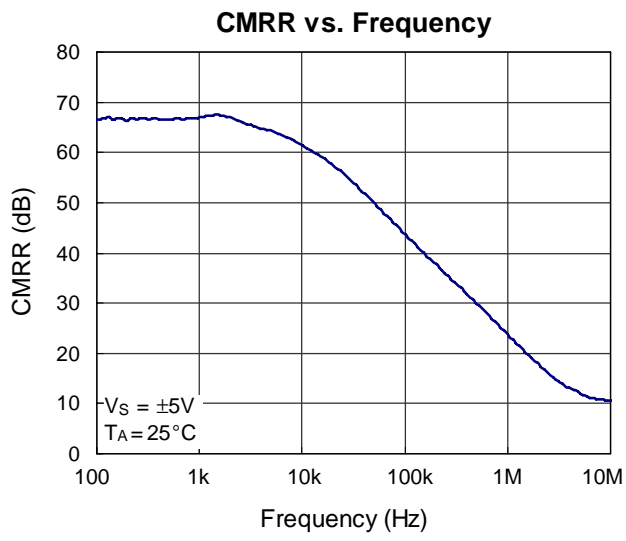



## Applications Information

The RT9133A/B has high performance to drive large load for different application. High slew rates, rail-to-rail input and output capability and low power consumption are the features to make the RT9133A/B ideal for LCD applications. The RT9133A/B also has wide bandwidth and phase margin to drive a load of 10kΩ and 10pF.

### Operating Voltage

The RT9133A/B is specified with single supply voltage from 5V to 15V. According to the electrical characteristics, the total supply voltage range is guaranteed from 4.5V to 15V. To refer the typical operational curves can get stable specifications in wide range of temperature and operating voltage.

The output swing of the RT9133A/B typically extends to within 80mV of positive/negative supply rails with 5mA load current source/sink. Decreasing the load current will get output swing even closer to the supply rails. Figure 1 shows the rail-to-rail input and output waveforms in the unit gain configuration without load current. The supply rails are +/-5V. Applying an input 10Vp\_p sinusoidal waveform results in a 9.8Vp\_p output voltage as shown in Figure 1.

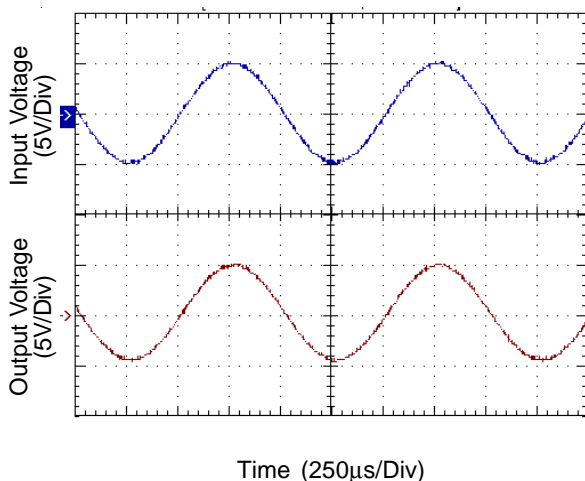

Figure 1. Operation with Rail-to-Rail Input and Output

### Power Dissipation

The maximum power dissipation depends on the thermal resistance of IC package, PCB layout, the rate of surroundings airflow and temperature difference between

junction to ambient. The maximum power dissipation can be calculated by following formula:

$$P_{D(MAX)} = (T_{J(MAX)} - T_A) / \theta_{JA}$$

Where

$T_{J(MAX)}$ : The maximum operation junction temperature 150°C

$T_A$ : The ambient temperature.

$\theta_{JA}$ : The junction to ambient thermal resistance.

The recommended operating condition of RT9133A/B is below the maximum junction temperature 150°C of the die. The junction to ambient thermal resistance for SOT-23-5 package is 250°C/W, WDFN-6L 2x2 package is 165°C/W and MSOP-8 package is 160°C/W on the standard JEDEC 51-3 single layer thermal test board. The maximum power dissipation at  $T_A = 25^\circ\text{C}$  can be calculated by following formula:

$$P_{D(MAX)} = (150^\circ\text{C} - 25^\circ\text{C}) / 250 = 500\text{mW (SOT-23-5)}$$

$$P_{D(MAX)} = (150^\circ\text{C} - 25^\circ\text{C}) / 165 = 758\text{mW (WDFN-6L 2x2)}$$

$$P_{D(MAX)} = (150^\circ\text{C} - 25^\circ\text{C}) / 160 = 781\text{mW (MSOP-8)}$$

For continuous operation, do not exceed absolute maximum operation junction temperature 150°C. The power dissipation definition for the RT9133A/B is as following:

$$P_D = (V_S - V_{OUT}) \times I_{Load}$$

$V_S$ : the supply voltage

$V_{OUT}$ : the output voltage

$I_{Load}$ : the output load current

The maximum power dissipation depends on operating ambient temperature for fixed  $T_{J(MAX)}$  and thermal resistance  $\theta_{JA}$ . Figure 2 shows the power dissipation derating curves of the RT9133A/B with different packages. As the ambient temperature increases, the maximum power dissipation decreases linearly to keep the junction temperature below 150°C.

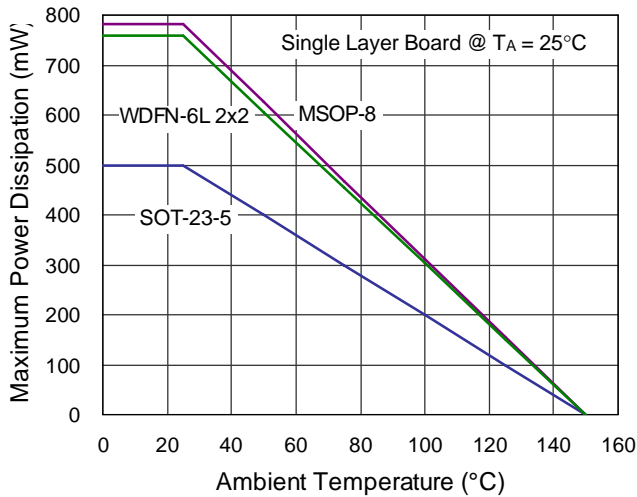

Figure 2. Derating Curves for the RT9133A/B Package

**Short Circuit Condition**

An internal short-circuit protection circuit is implemented to protect the device from output short circuit. The RT9133A/B limits the short circuit current to  $\pm 120\text{mA}$  if the output is directly shorted to positive/negative supply rails. For maximum reliability, the maximum continuous output current more than  $\pm 35\text{mA}$  is not recommended.

**Unused Amplifier**

It is recommended to connect the unused amplifier as a unit gain circuit. The negative input is directly connected to the output and the positive input should be connected to the ground.

**LCD Panel Applications**

The RT9133A/B is mainly designed for LCD gamma and V-com buffer. OP Amplifier has 120mA instantaneous source/sink peak current. To test the performance of the RT9133A/B for LCD driving capability, the test circuit is to simulate the V-com driver as shown Figure 3. Series capacitors and resistors connected to the output of the OP simulate the load of LCD panel. The  $300\Omega$  and  $3\text{k}\Omega$  feedback resistors are used to improve the settling time. This circuit is the worst case for a V-com buffer. Figure 4 shows the waveforms of the output peak current capability.

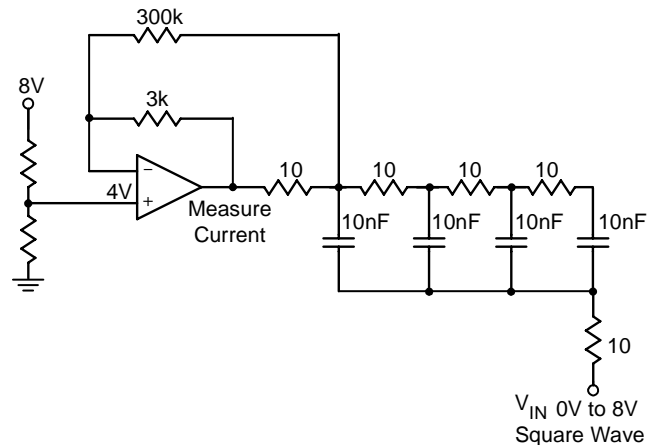

Figure 3. V-com Test Circuit

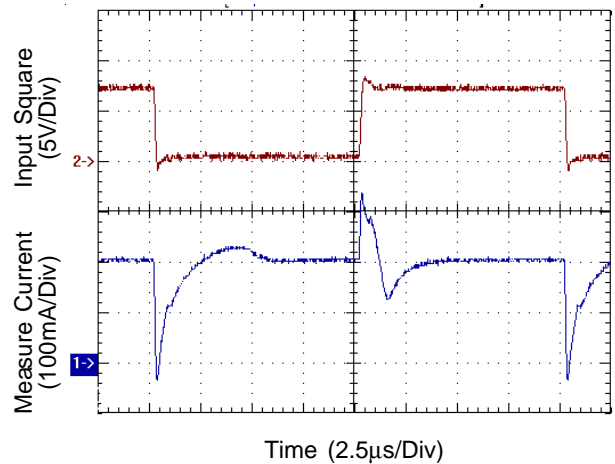
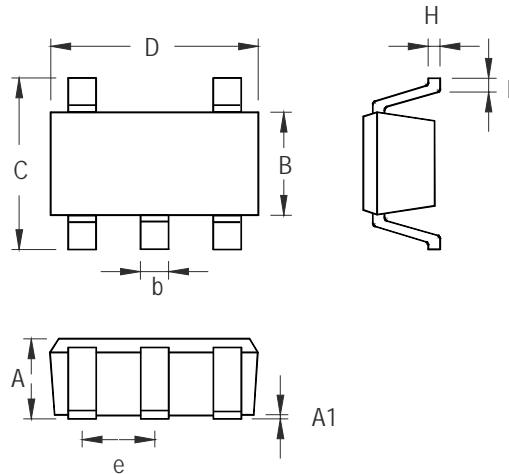

Figure 4. Scope Photo of the V-com Peak Current

**Outline Dimension**



Symbol	Dimensions In Millimeters		Dimensions In Inches	
	Min	Max	Min	Max
A	0.889	1.295	0.035	0.051
A1	0.000	0.152	0.000	0.006
B	1.397	1.803	0.055	0.071
b	0.356	0.559	0.014	0.022
C	2.591	2.997	0.102	0.118
D	2.692	3.099	0.106	0.122
e	0.838	1.041	0.033	0.041
H	0.080	0.254	0.003	0.010
L	0.300	0.610	0.012	0.024

**SOT-23-5 Surface Mount Package**

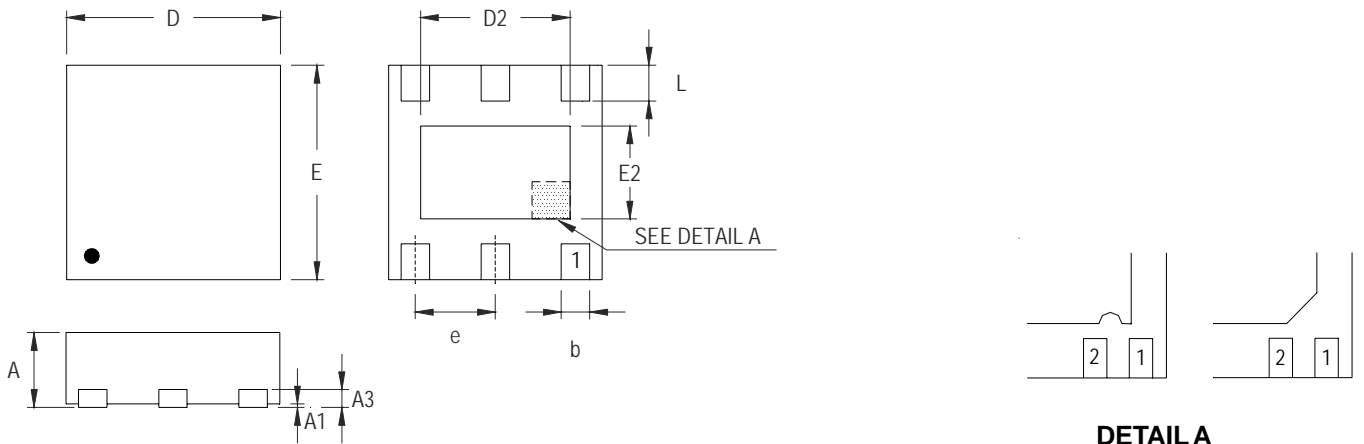

**DETAIL A**

Pin #1 ID and Tie Bar Mark Options

Note : The configuration of the Pin #1 identifier is optional, but must be located within the zone indicated.

Symbol	Dimensions In Millimeters		Dimensions In Inches	
	Min	Max	Min	Max
A	0.700	0.800	0.028	0.031
A1	0.000	0.050	0.000	0.002
A3	0.175	0.250	0.007	0.010
b	0.200	0.350	0.008	0.014
D	1.950	2.050	0.077	0.081
D2	1.000	1.450	0.039	0.057
E	1.950	2.050	0.077	0.081
E2	0.500	0.850	0.020	0.033
e	0.650		0.026	
L	0.300	0.400	0.012	0.016

**W-Type 6L DFN 2x2 Package**

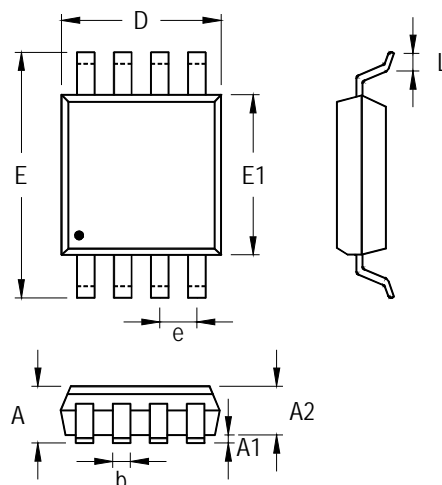

Symbol	Dimensions In Millimeters		Dimensions In Inches	
	Min	Max	Min	Max
A	0.810	1.100	0.032	0.043
A1	0.000	0.150	0.000	0.006
A2	0.750	0.950	0.030	0.037
b	0.220	0.380	0.009	0.015
D	2.900	3.100	0.114	0.122
e	0.650		0.026	
E	4.800	5.000	0.189	0.197
E1	2.900	3.100	0.114	0.122
L	0.400	0.800	0.016	0.031

**8-Lead MSOP Plastic Package**

**Richtek Technology Corporation**

Headquarter  
 5F, No. 20, Taiyuen Street, Chupei City  
 Hsinchu, Taiwan, R.O.C.  
 Tel: (8863)5526789 Fax: (8863)5526611

**Richtek Technology Corporation**

Taipei Office (Marketing)  
 5F, No. 95, Minchiuan Road, Hsintien City  
 Taipei County, Taiwan, R.O.C.  
 Tel: (8862)86672399 Fax: (8862)86672377  
 Email: marketing@richtek.com

Information that is provided by Richtek Technology Corporation is believed to be accurate and reliable. Richtek reserves the right to make any change in circuit design, specification or other related things if necessary without notice at any time. No third party intellectual property infringement of the applications should be guaranteed by users when integrating Richtek products into any application. No legal responsibility for any said applications is assumed by Richtek.

单击下面可查看定价，库存，交付和生命周期等信息

[>>Richtek\(台湾立锜\)](#)