

# 300mA, 0.5% Accuracy Low Dropout, Ultra Low Noise Voltage Regulator

## General Description

The RT9050 is a high-performance, 300mA LDO regulator, offering extremely high PSRR and ultra-low dropout. The RT9050 is ideal for portable RF and wireless applications with demanding performance and space requirements.

The RT9050 provides quiescent current to be as low as 25µA to extend the battery life. The RT9050 also works with low-ESR ceramic capacitors, reducing the amount of board space necessary for power applications, especially for hand-held wireless devices.

The RT9050 consumes typical 0.7µA in shutdown mode and has fast turn-on time to be less than 40µs. The other features include ultra-low dropout voltage, high output accuracy, current limiting protection, and high ripple rejection ratio. The RT9050 is available in the SOT-23-5 package.

## Ordering Information

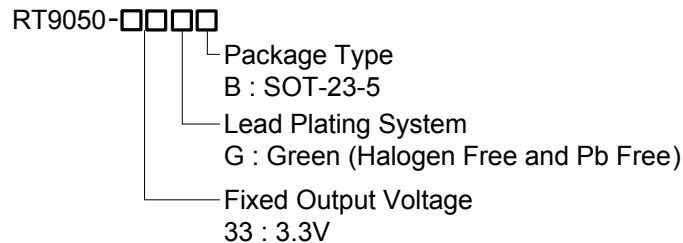

Note :

Richtek products are :

- ▶ RoHS compliant and compatible with the current requirements of IPC/JEDEC J-STD-020.
- ▶ Suitable for use in SnPb or Pb-free soldering processes.

## Marking Information

For marking information, contact our sales representative directly or through a Richtek distributor located in your area.

## Features

- Wide Operating Voltage Range : 3.8V to 5.5V
- Low Dropout : 150mV at 300mA
- Ultra-Low-Noise without Bypass Capacitor
- Ultra-Fast in Line/Load Transient Response
- Current Limit Protection
- Thermal Shutdown Protection
- High Power Supply Rejection Ratio
- Only 1µF Output Capacitor Required for Stability
- TTL-Logic-Controlled Shutdown Input
- RoHS Compliant and Halogen Free

## Applications

- CDMA/GSM Cellular Handsets
- Portable Information Appliances
- Laptop, Palmtops, Notebook Computers
- Hand-Held Instruments
- Mini PCI & PCI-Express Cards
- PCMCIA & New Cards

## Pin Configurations

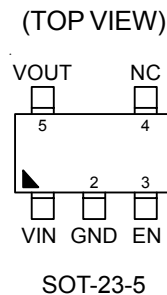

## Typical Application Circuit

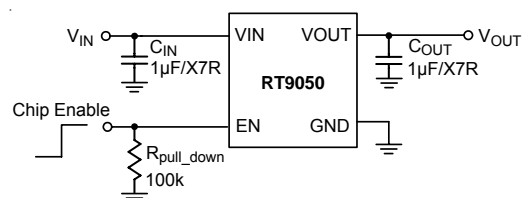

**Functional Pin Description**

Pin No.	Pin Name	Pin Function
1	VIN	Power Supply Input.
2	GND	Ground Pin.
3	EN	Chip Enable (Active High). It is recommended to add a 100kΩ resistor between the EN and GND.
4	NC	No Internal Connection.
5	VOUT	Regulator Output.

**Function Block Diagram**

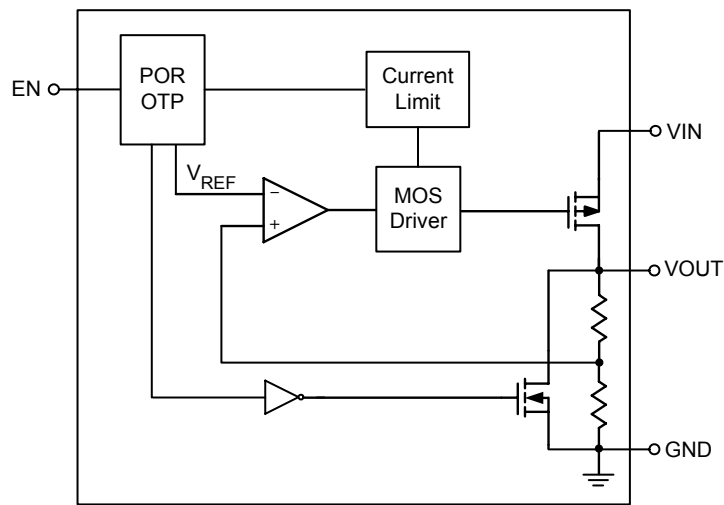

**Absolute Maximum Ratings** (Note 1)

- Supply Input Voltage ----- 6V
- EN Input Voltage ----- 6V
- Power Dissipation, P<sub>D</sub> @ T<sub>A</sub> = 25°C
  - SOT-23-5 ----- 0.4W
- Package Thermal Resistance (Note 2)
  - SOT-23-5, θ<sub>JA</sub> ----- 250°C/W
- Lead Temperature (Soldering, 10 sec.) ----- 260°C
- Junction Temperature ----- 150°C
- Storage Temperature Range ----- -65°C to 150°C
- ESD Susceptibility (Note 3)
  - HBM ----- 2kV
  - MM ----- 200V

**Recommended Operating Conditions** (Note 4)

- Supply Input Voltage ----- 3.8V to 5.5V
- Junction Temperature Range ----- -40°C to 125°C
- Ambient Temperature Range ----- -40°C to 85°C

**Electrical Characteristics**

( $V_{IN} = V_{OUT} + 0.5V$ ,  $V_{EN} = V_{IN}$ ,  $C_{IN} = C_{OUT} = 1\mu F/X7R$  (Ceramic),  $T_A = 25^\circ C$ , unless otherwise specified)

Parameter	Symbol	Test Conditions	Min	Typ	Max	Unit
Output Noise Voltage	$V_{ON}$		--	30	--	$\mu V_{RMS}$
Output Voltage Accuracy	$\Delta V_{OUT}$	$1mA \leq I_{OUT} \leq 150mA$ , $T_J = 25^\circ C$	-0.5	0	+0.5	%
Quiescent Current (Note 5)	$I_Q$	$I_{OUT} = 0mA$	--	25	50	$\mu A$
Shutdown Current	$I_{SHDN}$	$V_{EN} = 0V$	--	0.7	1.5	$\mu A$
Current Limit	$I_{LIM}$	$R_{LOAD} = 0\Omega$	300	400	600	mA
Dropout Voltage (Note 6)	$V_{DROP}$	$I_{OUT} = 300mA$	--	125	240	mV
Load Regulation (Note 7)	$\Delta V_{LOAD}$	$1mA < I_{OUT} < 300mA$	--	--	1	%
EN Threshold	Logic-Low Voltage	$V_{IL}$	0	--	0.6	V
	Logic-High Voltage	$V_{IH}$	1.6	--	5.5	
Enable Pin Current	$I_{EN}$		--	0.1	1	$\mu A$
Power Supply Rejection Rate	PSRR	$I_{OUT} = 100mA$ , $f = 10kHz$	--	-50	--	dB
Line Regulation	$\Delta V_{LINE}$	$V_{IN} = (V_{OUT} + 0.5V)$ to 5.5V, $I_{OUT} = 1mA$	--	0.01	0.2	%/V
Thermal Shutdown Temperature	$T_{SD}$		--	170	--	$^\circ C$
Thermal Shutdown Hysteresis	$\Delta T_{SD}$		--	30	--	

**Note 1.** Stresses listed as the above "Absolute Maximum Ratings" may cause permanent damage to the device. These are for stress ratings. Functional operation of the device at these or any other conditions beyond those indicated in the operational sections of the specifications is not implied. Exposure to absolute maximum rating conditions for extended periods may remain possibility to affect device reliability.

**Note 2.**  $\theta_{JA}$  is measured in the natural convection at  $T_A = 25^\circ C$  on a low effective thermal conductivity single layer test board of JEDEC 51-3 thermal measurement standard.

**Note 3.** Devices are ESD sensitive. Handling precaution is recommended.

**Note 4.** The device is not guaranteed to function outside its operating conditions.

**Note 5.** Quiescent, or ground current, is the difference between input and output currents. It is defined by  $I_Q = I_{IN} - I_{OUT}$  under no load condition ( $I_{OUT} = 0mA$ ). The total current drawn from the supply is the sum of the load current plus the ground pin current.

**Note 6.** The dropout voltage is defined as  $V_{IN} - V_{OUT}$ , which is measured when  $V_{OUT}$  is  $V_{OUT(NORMAL)} - 100mV$ .

**Note 7.** Regulation is measured at constant junction temperature by using a 2ms current pulse. Devices are tested for load regulation in the load range from 10mA to 300mA.

**Note 8.** The output voltage variation is typical  $\pm 0.5\%$  within recommended operating temperature range.

Typical Operating Characteristics

( $C_{IN} = C_{OUT} = 1\mu/X7R$ , unless otherwise specified)

Output Voltage vs. Temperature

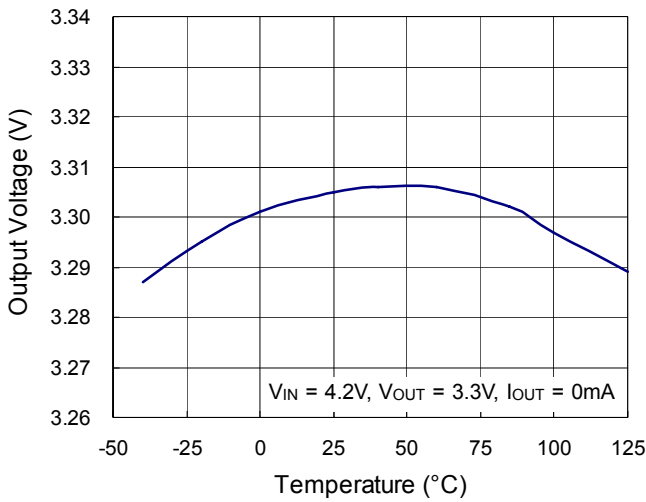

Quiescent Current vs. Temperature

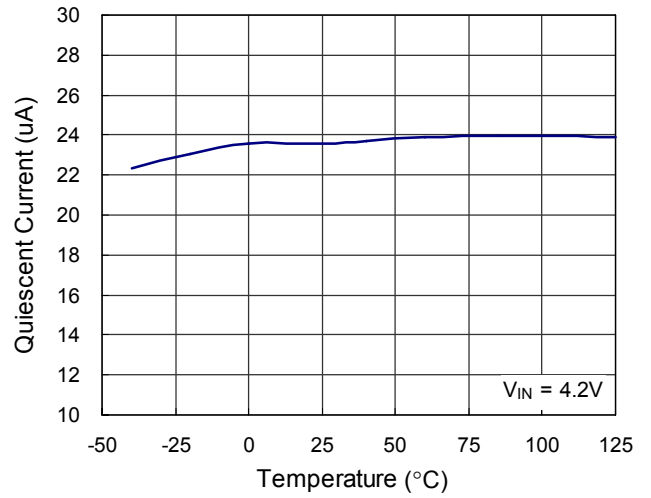

Dropout Voltage vs. Load Current

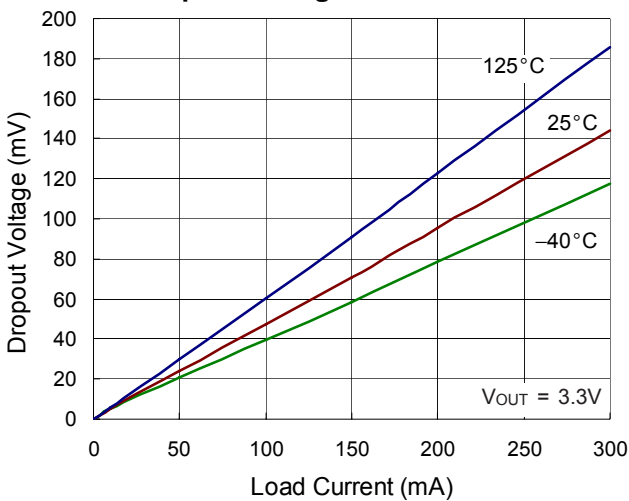

EN Pin Shutdown Response

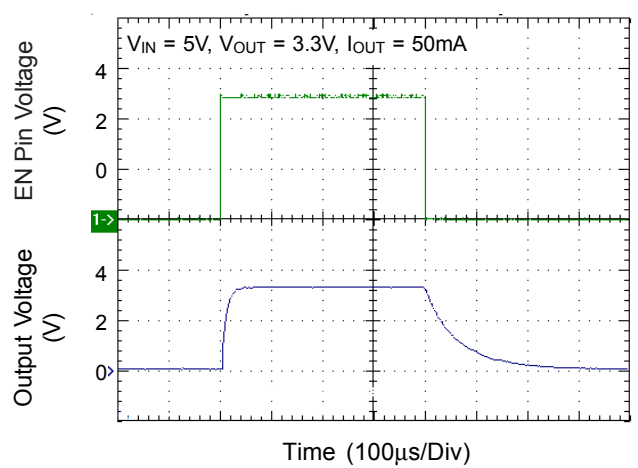

Start Up

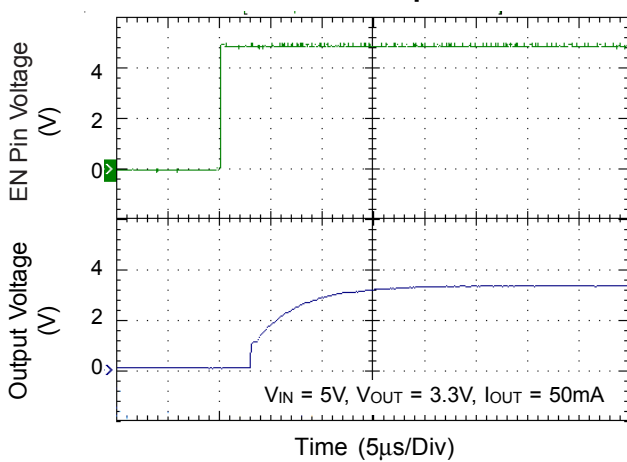

Line Transient Response

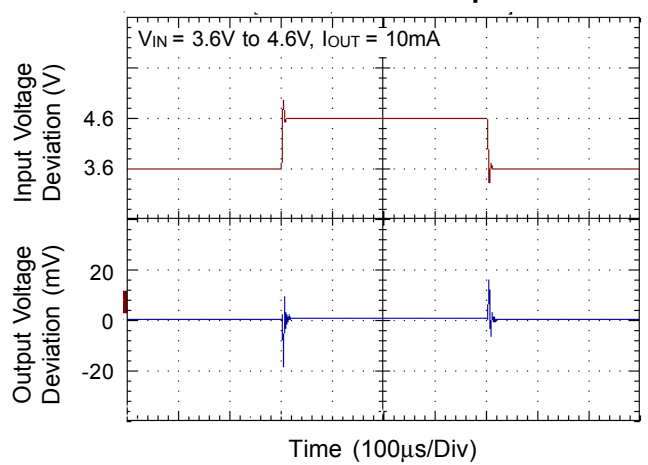

Line Transient Response

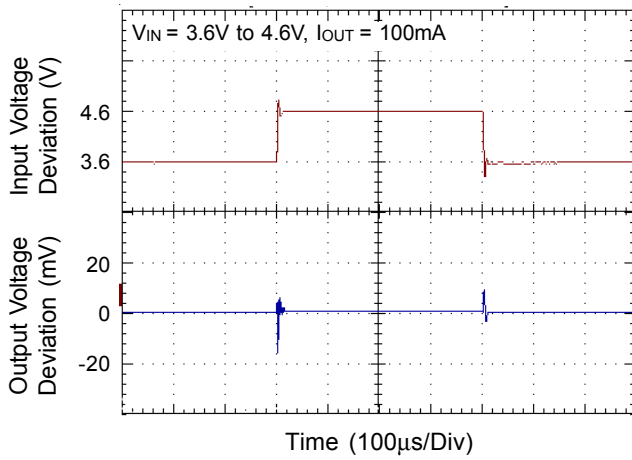

Noise

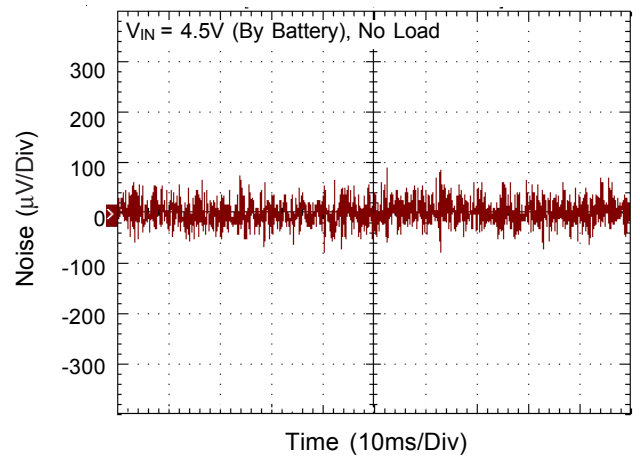

Noise

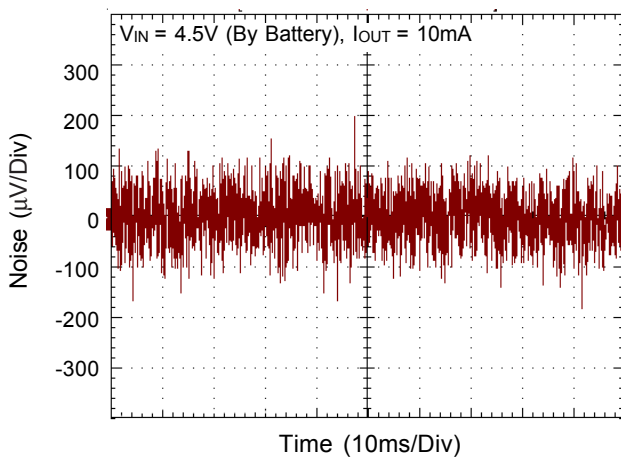

PSRR

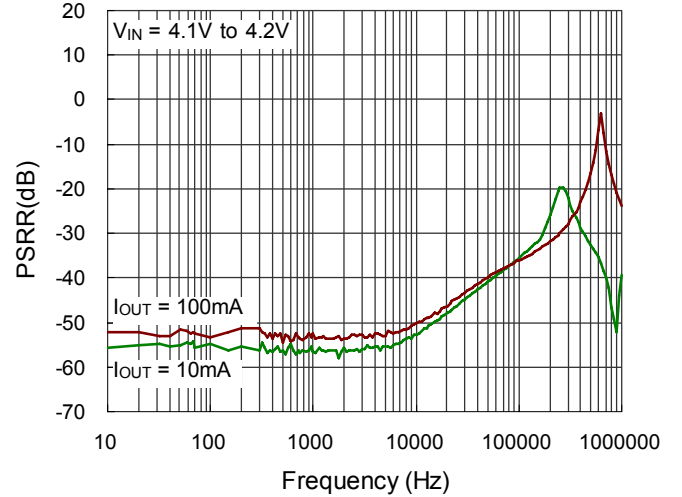

Load Transient Response

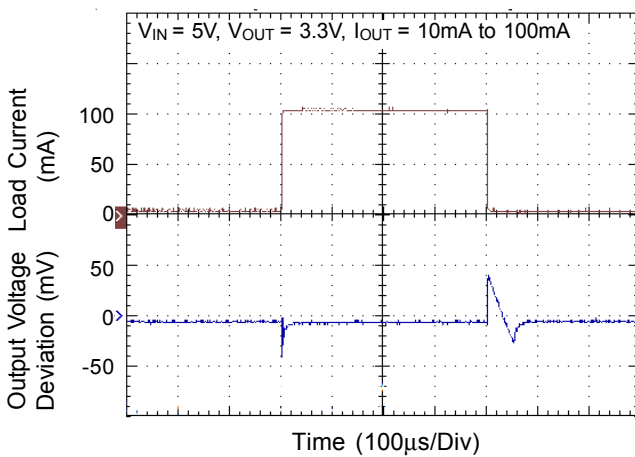

Load Transient Response

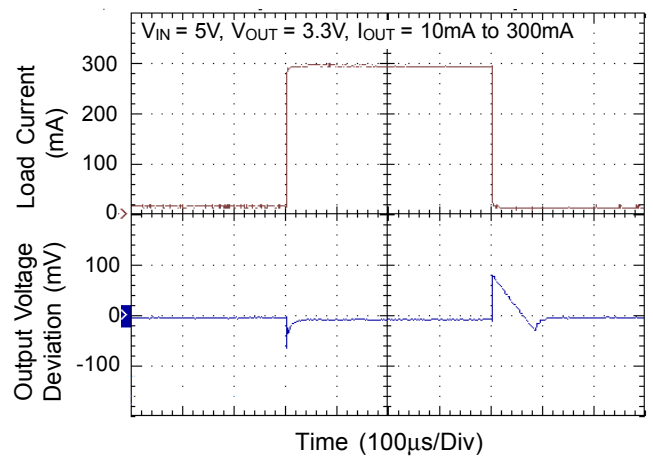

**Applications Information**

Like any low-dropout regulator, the external capacitors used with the RT9050 must be carefully selected for regulator stability and performance. Using a capacitor whose value is  $> 1\mu\text{F} / X7R$  on the RT9050 input and the amount of capacitance can be increased without limit. The input capacitor must be located at a distance of not more than 0.5 inch from the input pin of the IC and returned to a clean analog ground. Any good quality ceramic can be used for this capacitor. The capacitor with larger value and lower ESR (equivalent series resistance) provides better PSRR and line-transient response.

The output capacitor must meet both requirements for minimum amount of capacitance and ESR in all LDOs application. The RT9050 is designed specifically to work with low ESR ceramic output capacitor in space-saving and performance consideration. Using a ceramic capacitor whose value is at least  $1\mu\text{F}$  with ESR is  $> 20\text{m}\Omega$  on the RT9050 output ensures stability. The RT9050 still works well with output capacitor of other types due to the wide stable ESR range. Figure 1. shows the curves of allowable ESR range as a function of load current for various output capacitor values. Output capacitor of larger capacitance can reduce noise and improve load transient response, stability, and PSRR. The output capacitor should be located at not more than 0.5 inch from the VOUT pin of the RT9050 and returned to a clean analog ground.

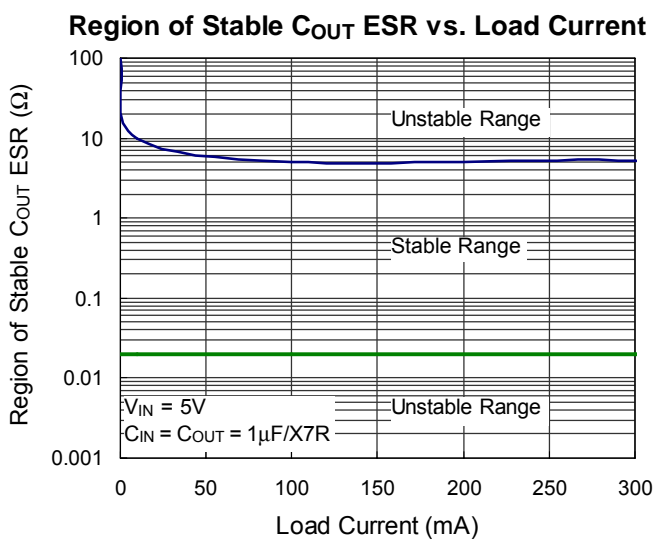

Figure 1

**Enable**

The RT9050 goes into sleep mode when the EN pin is in a logic low condition. During this condition, the RT9050 has an EN pin to turn on or turn off the regulator, When the EN pin is in logic high, the regulator will be turned on. The shutdown current is  $0.7\mu\text{A}$  typical. The EN pin may be directly tied to  $V_{IN}$  to keep the part on. The Enable input is CMOS logic and cannot be left floating.

**PSRR**

The power supply rejection ratio (PSRR) is defined as the gain from the input to output divided by the gain from the supply to the output. The PSRR is found to be

$$PSRR = 20 \times \log \left( \frac{\Delta \text{Gain Error}}{\Delta \text{Supply}} \right)$$

Note that in heavy load measuring,  $\Delta \text{supply}$  will cause  $\Delta \text{temperature}$ . And  $\Delta \text{temperature}$  will cause  $\Delta \text{output voltage}$ . So the temperature effect is include in heavy load PSRR measuring.

**Current Limit**

The RT9050 contains an independent current limiter, which monitors and controls the pass transistor's gate voltage, limiting the output current to  $0.4\text{A}$  (typ.). The output can be shorted to ground indefinitely without damaging the part.

**Thermal Considerations**

Thermal protection limits power dissipation in the RT9050. When the operation junction temperature exceeds  $170^\circ\text{C}$ , the OTP circuit starts the thermal shutdown function and turns the pass element off. The pass element will be turned on again after the junction temperature cools by  $30^\circ\text{C}$ .

For continuous operation, do not exceed absolute maximum operation junction temperature  $125^\circ\text{C}$ . The power dissipation definition in the device is calculated as follows :

$$P_D = (V_{IN} - V_{OUT}) \times I_{OUT} + V_{IN} \times I_Q$$

The maximum power dissipation depends on the thermal resistance of IC package, PCB layout, the rate of surroundings airflow and temperature difference between junction to ambient. The maximum power dissipation can be calculated by following formula :

$$P_{D(MAX)} = ( T_{J(MAX)} - T_A ) / \theta_{JA}$$

Where  $T_{J(MAX)}$  is the maximum operation junction temperature,  $T_A$  is the ambient temperature and the  $\theta_{JA}$  is the junction to ambient thermal resistance.

For recommended operating conditions specification of the RT9050, the maximum junction temperature is 125°C. The junction to ambient thermal resistance for SOT-23-5 package is 250°C/W on the standard JEDEC 51-3 single-layer thermal test board. The maximum power dissipation at  $T_A = 25^\circ\text{C}$  can be calculated by following formula :

$$P_{D(MAX)} = ( 125^\circ\text{C} - 25^\circ\text{C} ) / ( 250^\circ\text{C/W} ) = 0.4\text{W for SOT-23-5 package}$$

The maximum power dissipation depends on operating ambient temperature for fixed  $T_{J(MAX)}$  and thermal resistance  $\theta_{JA}$ . For RT9050 package, the Figure 2 of derating curve allows the designer to see the effect of rising ambient temperature on the maximum power dissipation allowed.

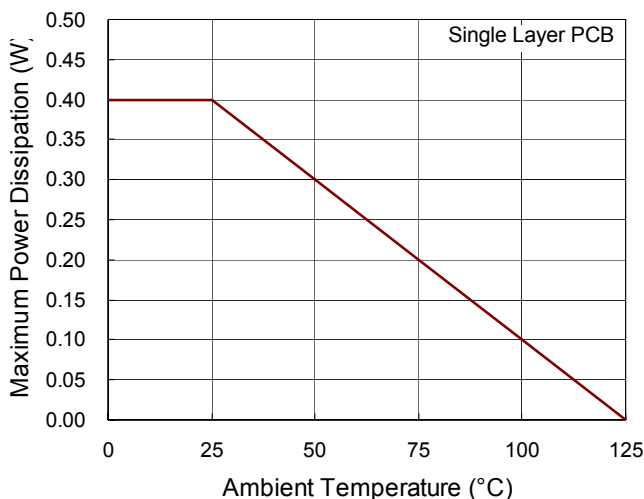
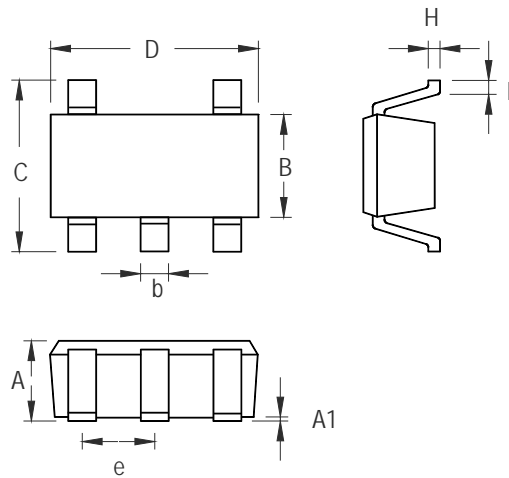

Figure 2. Derating Curve for RT9050 Package

Outline Dimension



Symbol	Dimensions In Millimeters		Dimensions In Inches	
	Min	Max	Min	Max
A	0.889	1.295	0.035	0.051
A1	0.000	0.152	0.000	0.006
B	1.397	1.803	0.055	0.071
b	0.356	0.559	0.014	0.022
C	2.591	2.997	0.102	0.118
D	2.692	3.099	0.106	0.122
e	0.838	1.041	0.033	0.041
H	0.080	0.254	0.003	0.010
L	0.300	0.610	0.012	0.024

SOT-23-5 Surface Mount Package

**Richtek Technology Corporation**

Headquarter  
 5F, No. 20, Taiyuen Street, Chupei City  
 Hsinchu, Taiwan, R.O.C.  
 Tel: (8863)5526789 Fax: (8863)5526611

**Richtek Technology Corporation**

Taipei Office (Marketing)  
 5F, No. 95, Minchiuan Road, Hsintien City  
 Taipei County, Taiwan, R.O.C.  
 Tel: (8862)86672399 Fax: (8862)86672377  
 Email: marketing@richtek.com

Information that is provided by Richtek Technology Corporation is believed to be accurate and reliable. Richtek reserves the right to make any change in circuit design, specification or other related things if necessary without notice at any time. No third party intellectual property infringement of the applications should be guaranteed by users when integrating Richtek products into any application. No legal responsibility for any said applications is assumed by Richtek.



单击下面可查看定价，库存，交付和生命周期等信息

[>>Richtek\(台湾立锜\)](#)