

2A, 24V, 500kHz, ACOT™ Step-Down Converter

General Description

The RT6215E is a high-efficiency, monolithic synchronous step-down DC-DC converter that can deliver up to 2A output current from a 4.5V to 24V input supply. The RT6215E adopts advanced constant on-time (ACOT™) architecture to provides a very fast transient response with few external components and keep in constant frequency. Cycle-by-cycle current limit provides protection against shorted outputs and soft-start eliminates input current surge during start-up. Input under-voltage lock-out, output under-voltage protection, over-current protection, and over-temperature protection offer completely safe and smooth operation in all applied conditions.

Ordering Information

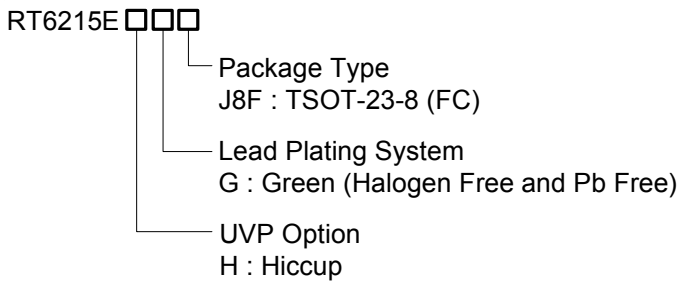

Note :

Richtek products are :

- ▶ RoHS compliant and compatible with the current requirements of IPC/JEDEC J-STD-020.
- ▶ Suitable for use in SnPb or Pb-free soldering processes.

Features

- 4.5V to 24V Input Voltage Range
- 2A Output Current
- 500kHz Switching Frequency
- Advanced Constant On-Time Control
- Fast Transient Response
- Stable with Low ESR Ceramic Output Capacitors
- Adjustable Output Voltage from 0.791V to 5V
- Integrated 100mΩ/85mΩ MOSFETs
- Monotonic Start-Up into Pre-Biased Outputs
- Enable Control
- Cycle-by-Cycle Over Current Limit Protection
- Input Under-Voltage Lockout
- Output Under-Voltage Protection with Hiccup Mode
- Over-Temperature Protection
- RoHS Compliant and Halogen Free

Applications

- Set Top Box
- Portable TV
- Access Point Router
- DSL Modem
- LCD TV

Marking Information

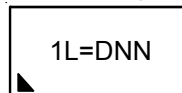

1L : Product Code
DNN : Date Code

Simplified Application Circuit

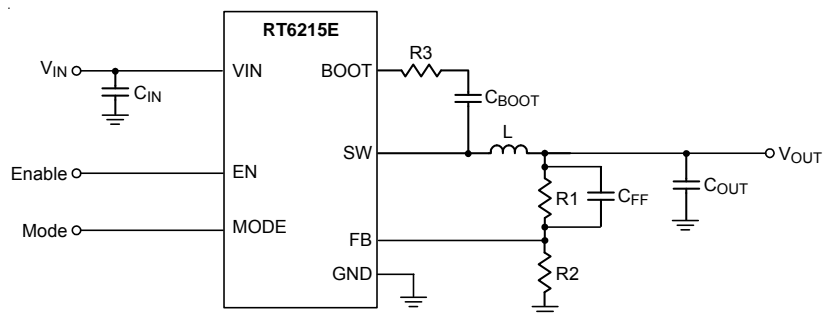

Pin Configuration

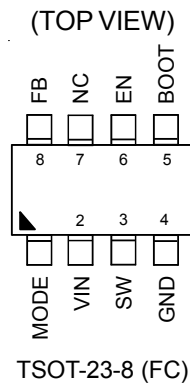

Functional Pin Description

Pin No.	Pin Name	Pin Function
1	MODE	Mode selection input. Set MODE pin high will force the RT6215E into CCM. Connect MODE to VIN with a 100kΩ resistor for CCM application. Connect MODE pin to ground to force the RT6215E into Pulse Skipping Mode for light load. Do not float MODE pin.
2	VIN	Input voltage. Support 4.5 to 24V input voltage. Must bypass with a suitable large ceramic capacitor at this pin.
3	SW	Switch node. Connected to external L-C filter.
4	GND	System ground.
5	BOOT	Bootstrap supply for high-side gate driver. Connect a 0.1μF ceramic capacitor between the BOOT and SW pins.
6	EN	Buck enable. High = enable.
7	NC	This pin is left to float.
8	FB	Feedback input. The pin is used to set the output voltage of the converter to regulate to the desired via a resistive divider.

Functional Block Diagram

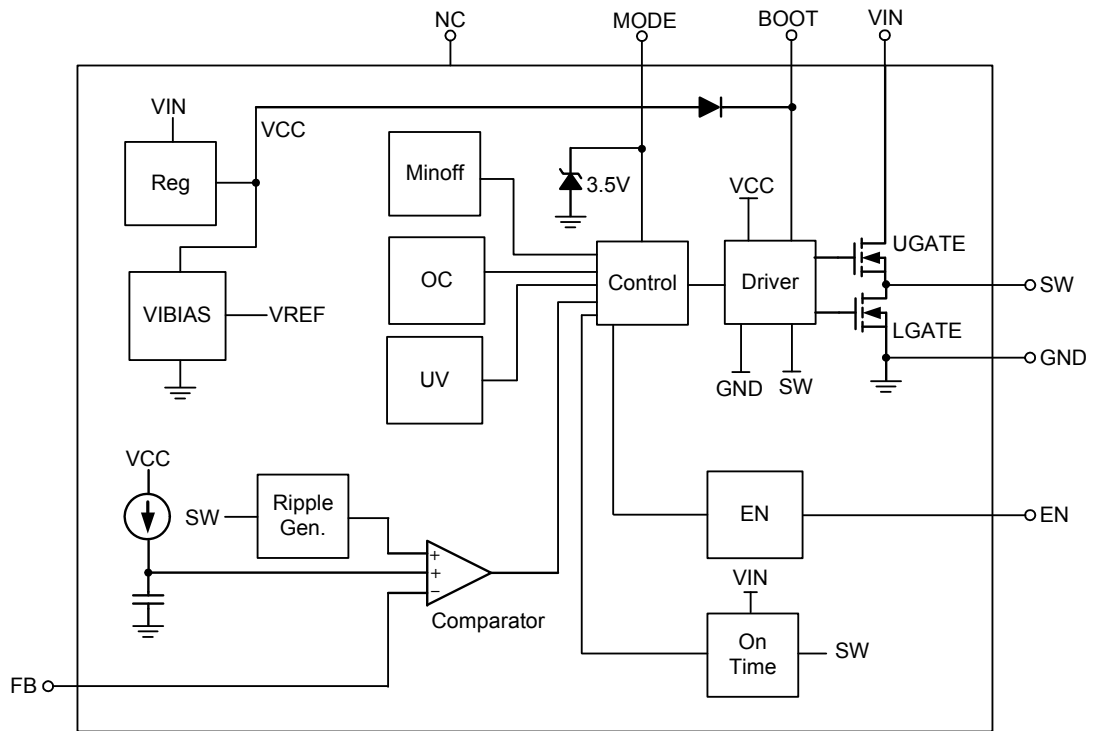

Operation

The RT6215E is a high-efficiency, monolithic synchronous step-down DC-DC converter that can deliver up to 2A output current from a 4.5V to 24V input supply. Using the ACOT™ control mode can reduce the output capacitance and perform fast transient response. It can minimize the component size without additional external compensation network.

Current Protection

The inductor current is monitored via the internal switches cycle-by-cycle. Once the output voltage drops under UV threshold, the RT6215E will enter hiccup mode.

Hiccup Mode

The RT6215E use hiccup mode for UVP. When the protection function is triggered, the IC will shut down for a period of time and then attempt to recover automatically. Hiccup mode allows the circuit to operate safely with low input current and power dissipation, and then resume normal operation as soon as the overload or short circuit is removed.

Input Under-Voltage Lockout

To protect the chip from operating at insufficient supply voltage, the UVLO is needed. When the input voltage of VIN is lower than the UVLO falling threshold voltage, the device will be lockout.

Shut-Down, Start-Up and Enable (EN)

The enable input (EN) has a logic-low level. When V_{EN} is below this level the IC enters shutdown mode. When V_{EN} exceeds its logic-high level the IC is fully operational.

External Bootstrap Capacitor

Connect a 0.1 μ F low ESR ceramic capacitor between BOOT and SW. This bootstrap capacitor provides the gate driver supply voltage for the high-side N-channel MOSFET switch.

Over-Temperature Protection

The RT6215E includes an over-temperature protection (OTP) circuitry to prevent overheating due to excessive power dissipation. The OTP will shut down switching

operation when the junction temperature exceeds the OTP threshold value. Once the junction temperature cools down and is lower than the OTP lower threshold, the IC will resume normal operation.

UVP Protection

The RT6215E detects under-voltage conditions by monitoring the feedback voltage on FB pin. When the feedback voltage is lower than 50% of the target voltage, the UVP comparator will go high to turn off both internal high-side and low-side MOSFETs.

Absolute Maximum Ratings (Note 1)

- Supply Input Voltage and EN Voltage, V_{IN} , EN ----- -0.3V to 28V
- Switch Voltage, SW ----- -0.3V to 28V
- SW ($t \leq 10\text{ns}$) ----- -5V to 30V
- BOOT to SW, $V_{BOOT} - V_{SW}$ ----- -0.3V to 6V
- BOOT Voltage ----- -0.3V to 34V
- Other Pins ----- -0.3V to 6V
- Power Dissipation, P_D @ $T_A = 25^\circ\text{C}$
- TSOT-23-8 (FC) ----- 1.428W
- Package Thermal Resistance (Note 2)
- TSOT-23-8 (FC), θ_{JA} ----- 70°C/W
- TSOT-23-8 (FC), θ_{JC} ----- 15°C/W
- Junction Temperature ----- 150°C
- Lead Temperature (Soldering, 10 sec.) ----- 260°C
- Storage Temperature Range ----- -65°C to 150°C
- ESD Susceptibility (Note 3)
- HBM (Human Body Model) ----- 2kV

Recommended Operating Conditions (Note 4)

- Supply Input Voltage ----- 4.5V to 24V
- Junction Temperature Range ----- -40°C to 125°C
- Ambient Temperature Range ----- -40°C to 85°C

Electrical Characteristics

($V_{IN} = 12\text{V}$, $T_A = 25^\circ\text{C}$, unless otherwise specified)

Parameter	Symbol	Test Conditions	Min	Typ	Max	Unit
Supply Voltage						
VIN Supply Input Operating Voltage	V_{IN}		4.5	--	24	V
VIN Under-Voltage Lockout Threshold	V_{UVLO}	V_{IN} rising	3.9	4.1	4.3	V
VIN Under-Voltage Lockout Threshold-Hysteresis	ΔV_{UVLO}		--	550	--	mV
Supply Current						
Supply Current (Shutdown)	I_{SHDN}	$V_{EN} = 0\text{V}$	--	--	10	μA
Supply Current (Quiescent)	I_Q	$V_{EN} = 2\text{V}$, $V_{FB} = 1\text{V}$	--	170	270	μA
Soft-Start						
Internal Soft-Start Period	t_{SS}	V_{FB} from 0% to 100%	--	1500	--	μs
Enable Voltage						
EN Rising Threshold	V_{ENH}		1.2	1.4	1.6	V
EN Falling Threshold	V_{ENL}		1.1	1.25	1.4	V
Feedback Voltage						
Feedback Threshold Voltage	V_{FB}		779	791	803	mV

Parameter	Symbol	Test Conditions	Min	Typ	Max	Unit
Internal MOSFET						
High-Side Switch-On Resistance	R _{DS(ON)_H}	V _{BOOT} -V _{SW} = 4.8V	--	100	--	mΩ
Low-Side Switch-On Resistance	R _{DS(ON)_L}		--	85	--	mΩ
Current Limit						
Low-Side Switch Valley Current Limit	I _{LIM_L}		2.2	2.7	--	A
High-Side Switch Peak Current Limit	I _{LIM_H}		--	4	--	A
Switching Frequency						
Switching Frequency	f _{SW}		--	500	--	kHz
On-Time Timer Control						
Maximum Duty Cycle	D _{MAX}		--	90	--	%
Minimum On-Time	t _{ON(MIN)}		--	60	--	ns
Thermal Shutdown						
Thermal Shutdown	T _{SD}		--	160	--	°C
Thermal Hysteresis	ΔT _{SD}		--	25	--	°C
Output Under-Voltage Protection						
UVP Trip Threshold		UVP detected	--	50	--	%
		Hysteresis	--	10	--	%

Note 1. Stresses beyond those listed “Absolute Maximum Ratings” may cause permanent damage to the device. These are stress ratings only, and functional operation of the device at these or any other conditions beyond those indicated in the operational sections of the specifications is not implied. Exposure to absolute maximum rating conditions may affect device reliability.

Note 2. θ_{JA} is measured under natural convection (still air) at T_A = 25°C with the component mounted on a high effective-thermal-conductivity four-layer test board on a JEDEC 51-7 thermal measurement standard. The first layer is filled with copper. θ_{JC} is measured at the lead of the package.

Note 3. Devices are ESD sensitive. Handling precaution is recommended.

Note 4. The device is not guaranteed to function outside its operating conditions.

Typical Application Circuit

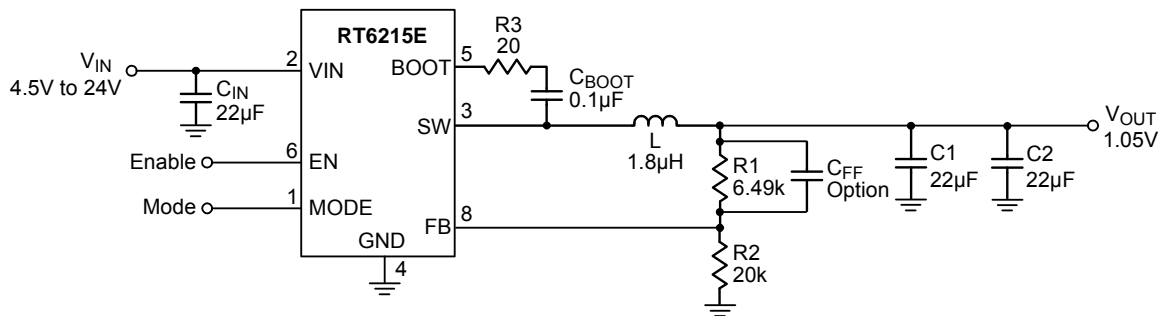

Table 1. Suggested Component Values

V _{OUT} (V)	R ₁ (kΩ)	R ₂ (kΩ)	L (µH)	C _{OUT} (µF)	C _{FF} (pF)
1.05	6.49	20	1.8	44	--
1.2	10.5	20	2.2	44	--
1.8	25.5	20	3.6	44	--
2.5	43.2	20	4.7	44	22 to 68
3.3	63.4	20	4.7	44	22 to 68
5	107	20	6.8	44	22 to 68

Note :

- (1) All the input and output capacitors are the suggested values, referring to the effective capacitances, subject to any de-rating effect, like a DC bias.
- (2) For low output voltage application, it can optimize the load transient response of the device by adding feedforward capacitor (C_{FF}, 22pF to 68pF).

Typical Operating Characteristics

Efficiency vs. Output Current

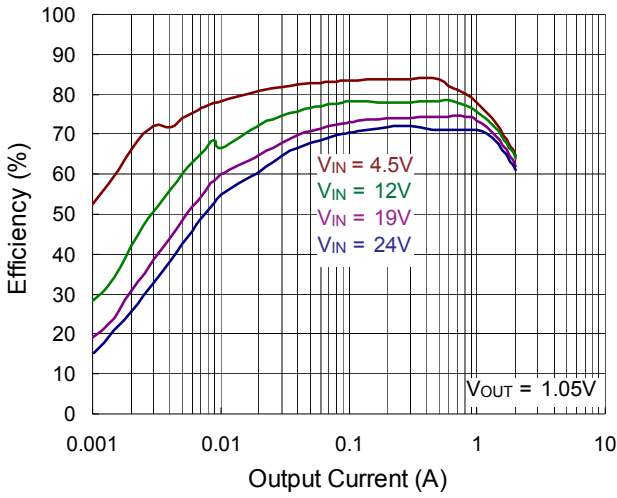

Output Voltage vs. Output Current

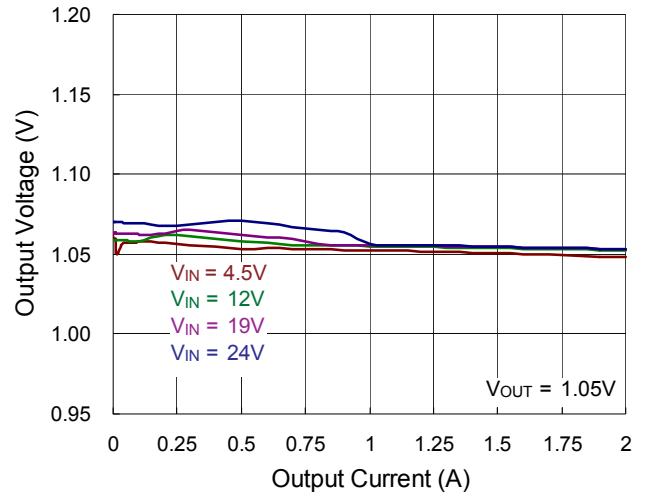

Load Transient Response

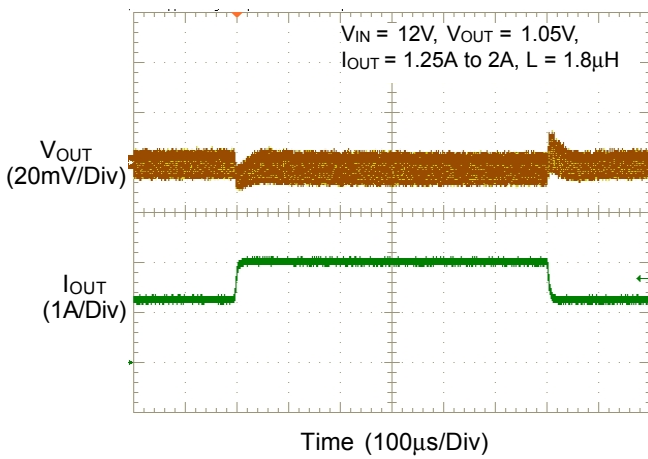

Output Ripple Voltage

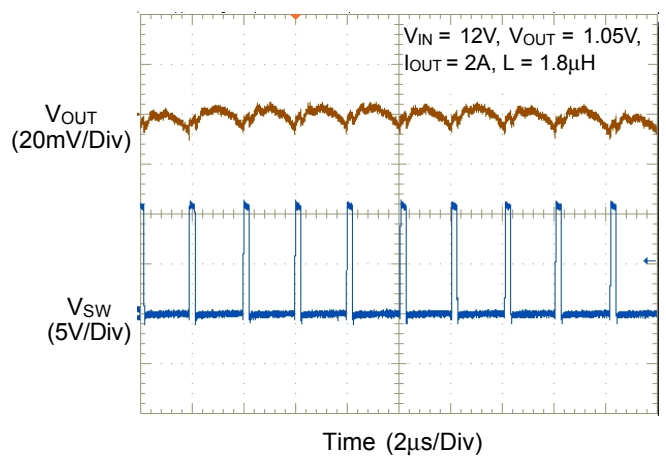

Power On from EN

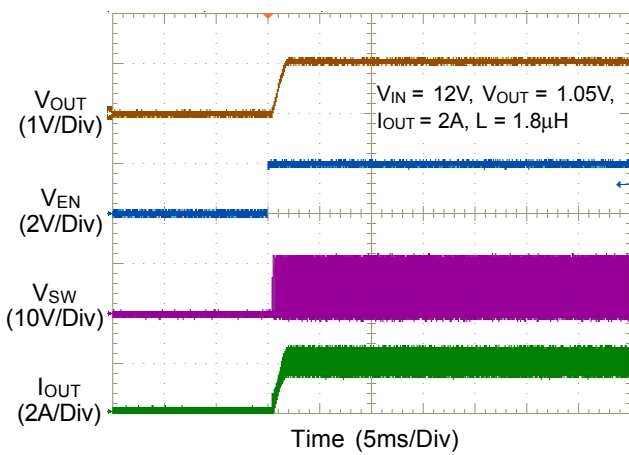

Power Off from EN

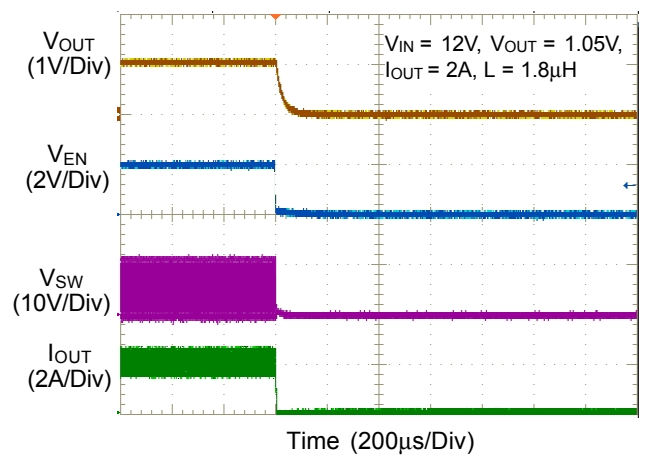

Power On from VIN

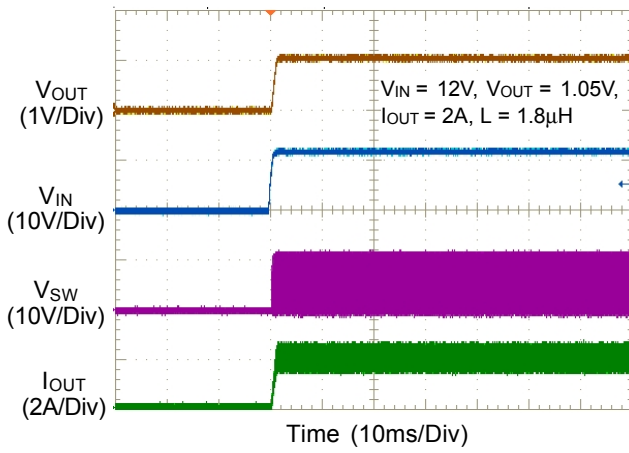

Power Off from VIN

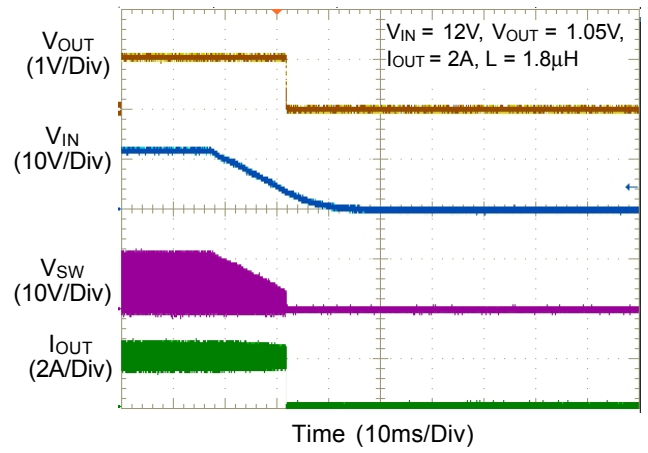

Application Information

Inductor Selection

The consideration of inductor selection includes inductance, RMS current rating and, saturation current rating. The inductance selection is generally flexible and is optimized for the low cost, low physical size, and high system performance.

Choosing lower inductance to reduce physical size and cost, and it is useful to improve the transient response. However, it causes the higher inductor peak current and output ripple voltage to decrease system efficiency. Conversely, higher inductance increase system efficiency, but the physical size of inductor will become larger and transient response will be slow because more transient time is required to change current (up or down) by inductor. A good compromise between size, efficiency, and transient response is to set a inductor ripple current (ΔI_L) about 20% to 50% of the desired full output load current.

Calculate the approximate inductance by the input voltage, output voltage, switching frequency (f_{SW}), maximum rated output current ($I_{OUT(MAX)}$) and inductor ripple current (ΔI_L).

$$L = \frac{V_{OUT} \times (V_{IN} - V_{OUT})}{V_{IN} \times f_{SW} \times \Delta I_L}$$

Once the inductance is chosen, the inductor ripple current (ΔI_L) and peak inductor current can be calculated.

$$\Delta I_L = \frac{V_{OUT} \times (V_{IN} - V_{OUT})}{V_{IN} \times f_{SW} \times L}$$

$$I_{L(PEAK)} = I_{OUT(MAX)} + \frac{1}{2} \Delta I_L$$

$$I_{L(VALLY)} = I_{OUT(MAX)} - \frac{1}{2} \Delta I_L$$

For the typical operating circuit design, the output voltage is 1.05V, maximum rated output current is 2A, input voltage is 12V, and inductor ripple current is 1A which is 50% of the maximum rated output current, the calculated inductance value is :

$$L = \frac{1.05 \times (12 - 1.05)}{12 \times 500 \times 10^3 \times 1} = 1.92 \mu H$$

The inductor ripple current set at 1A and so we select 1.8 μ H inductance. The actual inductor ripple current and required peak current is shown as below :

$$\Delta I_L = \frac{1.05 \times (12 - 1.05)}{12 \times 500 \times 10^3 \times 1.8 \times 10^{-6}} = 1.06 A$$

$$I_{L(PEAK)} = I_{OUT(MAX)} + \frac{1}{2} \Delta I_L = 2 + \frac{1.06}{2} = 2.53 A$$

Inductor saturation current should be chosen over IC's current limit.

Input Capacitor Selection

The input filter capacitors are needed to smooth out the RMS input ripple current drawn from the input power source and ripple voltage seen at the input of the converter. The voltage rating of the input filter capacitors must be greater than the maximum input voltage. It's also important to consider the ripple current capabilities of capacitors.

The RMS input ripple current (I_{RMS}) is a function of the input voltage (V_{IN}), output voltage (V_{OUT}), and rated output current (I_{OUT}) :

$$I_{RMS} = I_{OUT(MAX)} \times \frac{V_{OUT}}{V_{IN}} \sqrt{\frac{V_{IN}}{V_{OUT}} - 1}$$

The maximum RMS input ripple current occurs at maximum output load and it needs to be concerned about the ripple current capabilities of capacitors at maximum output load.

Ceramic capacitors are most often used because of their low cost, small size, high RMS current ratings, and robust surge current capabilities. It should pay attention that value of capacitors change as temperature, bias voltage, and operating frequency change. For example the capacitance value of a capacitor decreases as the dc bias across the capacitor increases.

However, take care when these capacitors are used at the input of circuits supplied by a wall adapter or other supply connected through long and thin wires. Current surges through the inductive wires can induce ringing at the IC's power input which could potentially cause large, damaging voltage spikes at VIN pin. If this phenomenon is observed, some bulk input capacitance may be required. Ceramic capacitors can be placed in parallel with

other types such as tantalum, electrolytic, or polymer to reduce voltage ringing and overshoot.

Choose capacitors rated at higher temperatures than required. Several ceramic capacitors may be paralleled to meet the RMS current, size, and height requirements of the application. The typical operating circuit use 22μF and one 0.1μF low ESR ceramic capacitors on the input.

Output Capacitor Selection

The RT6215E is optimized for output terminal with ceramic capacitors application and best performance will be obtained using them. The total output capacitance value is usually determined by the desired output ripple voltage level and transient response requirements for sag which is undershoot on positive load steps and soar which is overshoot on negative load steps.

Output Ripple Voltage

Output ripple voltage at the switching frequency is caused by the inductor current ripple and its effect on the output capacitor's ESR and stored charge. These two ripple components are called ESR ripple and capacitive ripple.

Since ceramic capacitors have extremely low ESR and relatively little capacitance, both components are similar in amplitude and both should be considered if ripple is critical.

$$V_{RIPPLE} = V_{RIPPLE(ESR)} + V_{RIPPLE(C)}$$

$$V_{RIPPLE(ESR)} = \Delta I_L \times R_{ESR}$$

$$V_{RIPPLE(C)} = \frac{\Delta I_L}{8 \times C_{OUT} \times f_{SW}}$$

Output Transient Undershoot and Overshoot

In addition to output ripple voltage at the switching frequency, the output capacitor and its ESR also affect the voltage sag (undershoot) and soar (overshoot) when the load steps up and down abruptly. The ACOT™ transient response is very quick and output transients are usually small. However, the combination of small ceramic output capacitors (with little capacitance), low output voltages (with little stored charge in the output capacitors), and low duty cycle applications (which require high inductance to get reasonable ripple currents with high input voltages) increases the size of voltage variations in response to

very quick load changes. Typically, load changes occur slowly with respect to the IC's 500kHz switching frequency.

But some modern digital loads can exhibit nearly instantaneous load changes and the following section shows how to calculate the worst-case voltage swings in response to very fast load steps.

The output voltage transient undershoot and overshoot each have two components : the voltage steps caused by the output capacitor's ESR, and the voltage sag and soar due to the finite output capacitance and the inductor current slew rate. Use the following formulas to check if the ESR is low enough (typically not a problem with ceramic capacitors) and the output capacitance is large enough to prevent excessive sag and soar on very fast load step edges, with the chosen inductor value.

The amplitude of the ESR step up or down is a function of the load step and the ESR of the output capacitor :

$$V_{ESR_STEP} = \Delta I_{OUT} \times R_{ESR}$$

The amplitude of the capacitive sag is a function of the load step, the output capacitor value, the inductor value, the input-to-output voltage differential, and the maximum duty cycle. The maximum duty cycle during a fast transient is a function of the on-time and the minimum off-time since the ACOT™ control scheme will ramp the current using on-times spaced apart with minimum off-times, which is as fast as allowed. Calculate the approximate on-time (neglecting parasitics) and maximum duty cycle for a given input and output voltage as :

$$t_{ON} = \frac{V_{OUT}}{V_{IN} \times f_{SW}} \text{ and } D_{MAX} = \frac{t_{ON}}{t_{ON} + t_{OFF(MIN)}}$$

The actual on-time will be slightly longer as the IC compensates for voltage drops in the circuit, but we can neglect both of these since the on-time increase compensates for the voltage losses. Calculate the output voltage sag as :

$$V_{SAG} = \frac{L \times (\Delta I_{OUT})^2}{2 \times C_{OUT} \times (V_{IN(MIN)} \times D_{MAX} - V_{OUT})}$$

The amplitude of the capacitive soar is a function of the load step, the output capacitor value, the inductor value and the output voltage :

$$V_{SOAR} = \frac{L \times (\Delta I_{OUT})^2}{2 \times C_{OUT} \times V_{OUT}}$$

Feed-Forward Capacitor (C_{FF})

The RT6215E is optimized for ceramic output capacitors and for low duty cycle applications. However for high-output voltages, with high feedback attenuation, the circuit's transient response can be slowed. The high-output voltage circuits transient response could be improved by adding a small "feedforward" capacitor (C_{FF}) across the upper FB divider resistor (Figure 1). Choose a suitable capacitor value that following suggested component BOM.

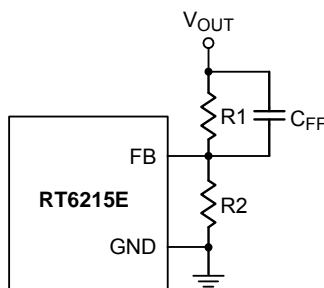

Figure 1. C_{FF} Capacitor Setting

Enable Operation (EN)

There is an internal 1MEG resistor from EN to GND. For automatic start-up the high-voltage EN pin can be connected to V_{IN}, through a 100kΩ resistor. Its large hysteresis band makes EN useful for simple delay and timing circuits. EN can be externally pulled to V_{IN} by adding a resistor-capacitor delay (R_{EN} and C_{EN} in Figure 2). Calculate the delay time using EN's internal threshold where switching operation begins.

An external MOSFET can be added to implement digital control of EN when no system voltage above 2V is available (Figure 3). In this case, a 100kΩ pull-up resistor, R_{EN}, is connected between V_{IN} and the EN pin. MOSFET Q1 will be under logic control to pull down the EN pin. To prevent enabling circuit when V_{IN} is smaller than the V_{OUT} target value or some other desired voltage level, a resistive voltage divider can be placed between the input voltage and ground and connected to EN to create an additional input under voltage lockout threshold (Figure 4).

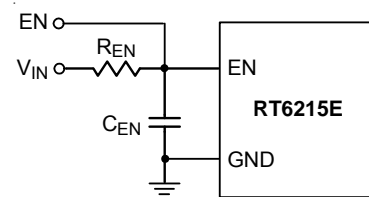

Figure 2. External Timing Control

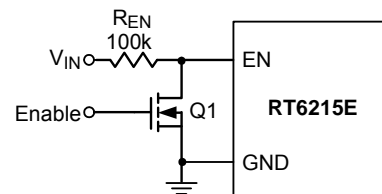

Figure 3. Digital Enable Control Circuit

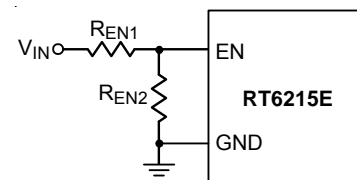

Figure 4. Resistor Divider for Lockout Threshold Setting

Output Voltage Setting

Set the desired output voltage using a resistive divider from the output to ground with the midpoint connected to FB. The output voltage is set according to the following equation :

$$V_{OUT} = 0.791V \times \left(1 + \frac{R1}{R2}\right)$$

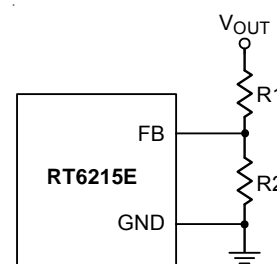

Figure 5. Output Voltage Setting

Place the FB resistors within 5mm of the FB pin. To minimize power consumption without excessive noise pick-up, considering typical application, fix $R_2 = 20k\Omega$ and calculate R_1 as follows :

$$R_1 = \frac{R_2 \times (V_{OUT} - V_{REF})}{V_{REF}}$$

For output voltage accuracy, use divider resistors with 1% or better tolerance.

External BOOT Bootstrap Diode

When the input voltage is lower than 5.5V it is recommended to add an external bootstrap diode between VIN and the BOOT pin to improve enhancement of the internal MOSFET switch and improve efficiency. The bootstrap diode can be a low cost one such as 1N4148 or BAT54.

External BOOT Capacitor Series Resistance

The internal power MOSFET switch gate driver is optimized to turn the switch on fast enough for low power loss and good efficiency, but also slow enough to reduce EMI. Switch turn-on is when most EMI occurs since V_{SW} rises rapidly. During switch turn-off, SW is discharged relatively slowly by the inductor current during the dead time between high-side and low-side switch on-times. In some cases it is desirable to reduce EMI further, at the expense of some additional power dissipation. The switch turn-on can be slowed by placing a small ($<47\Omega$) resistance between BOOT and the external bootstrap capacitor. This will slow the high-side switch turn-on and V_{SW} 's rise. To remove the resistor from the capacitor charging path (avoiding poor enhancement due to undercharging the BOOT capacitor), use the external diode shown in Figure 6 to charge the BOOT capacitor and place the resistance between BOOT and the capacitor/diode connection.

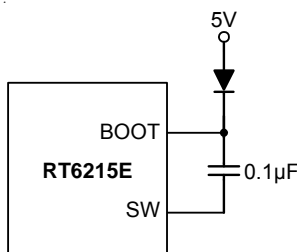

Figure 6. External Bootstrap Diode

Mode Selection setting

The RT6215E has MODE Selection function to set Pulse Skipping Mode for light load. To connect MODE pin to ground to force the RT6215E into Pulse Skipping Mode for light load efficiency improvement. Pulling the MODE pin high (i.e. $> 2V$) will force the RT6215E into CCM. In order to avoid the abnormal operation caused by noise, MODE pin can't be floated.

Thermal Considerations

The junction temperature should never exceed the absolute maximum junction temperature $T_{J(MAX)}$, listed under Absolute Maximum Ratings, to avoid permanent damage to the device. The maximum allowable power dissipation depends on the thermal resistance of the IC package, the PCB layout, the rate of surrounding airflow, and the difference between the junction and ambient temperatures. The maximum power dissipation can be calculated using the following formula :

$$P_{D(MAX)} = (T_{J(MAX)} - T_A) / \theta_{JA}$$

where $T_{J(MAX)}$ is the maximum junction temperature, T_A is the ambient temperature, and θ_{JA} is the junction-to-ambient thermal resistance.

For continuous operation, the maximum operating junction temperature indicated under Recommended Operating Conditions is $125^\circ C$. The junction-to-ambient thermal resistance, θ_{JA} , is highly package dependent. For a TSOT-23-8 (FC) package, the thermal resistance, θ_{JA} , is $70^\circ C/W$ on a standard JEDEC 51-7 high effective-thermal-conductivity four-layer test board. The maximum power dissipation at $T_A = 25^\circ C$ can be calculated as below :

$$P_{D(MAX)} = (125^\circ C - 25^\circ C) / (70^\circ C/W) = 1.428W \text{ for a TSOT-23-8 (FC) package.}$$

The maximum power dissipation depends on the operating ambient temperature for the fixed $T_{J(MAX)}$ and the thermal resistance, θ_{JA} . The derating curves in Figure 7 allows the designer to see the effect of rising ambient temperature on the maximum power dissipation.

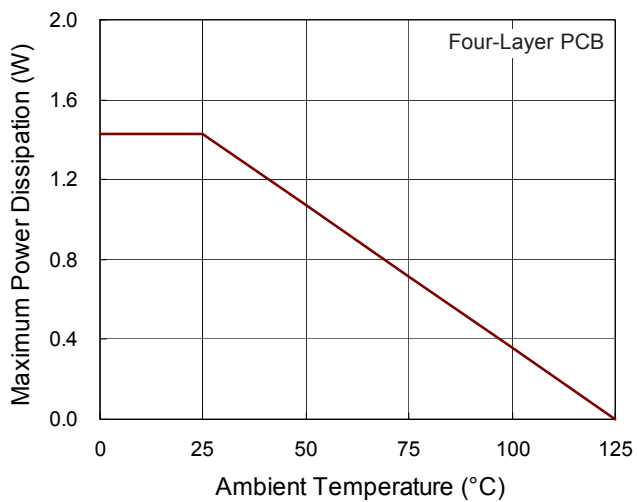
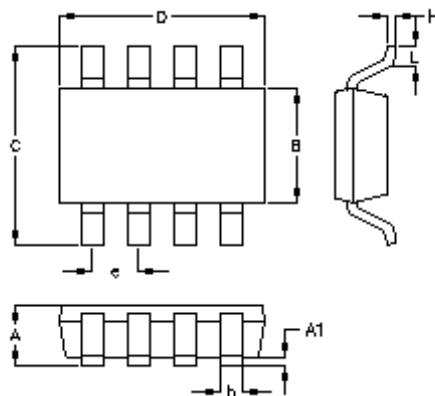

Figure 7. Derating Curve of Maximum Power Dissipation

Outline Dimension



Symbol	Dimensions In Millimeters		Dimensions In Inches	
	Min.	Max.	Min.	Max.
A	0.700	1.000	0.028	0.039
A1	0.000	0.100	0.000	0.004
B	1.397	1.803	0.055	0.071
b	0.220	0.380	0.009	0.015
C	2.591	3.000	0.102	0.118
D	2.692	3.099	0.106	0.122
e	0.585	0.715	0.023	0.028
H	0.080	0.254	0.003	0.010
L	0.300	0.610	0.012	0.024

TSOT-23-8 (FC) Surface Mount Package

Richtek Technology Corporation

14F, No. 8, Tai Yuen 1st Street, Chupei City
 Hsinchu, Taiwan, R.O.C.
 Tel: (8863)5526789

Richtek products are sold by description only. Richtek reserves the right to change the circuitry and/or specifications without notice at any time. Customers should obtain the latest relevant information and data sheets before placing orders and should verify that such information is current and complete. Richtek cannot assume responsibility for use of any circuitry other than circuitry entirely embodied in a Richtek product. Information furnished by Richtek is believed to be accurate and reliable. However, no responsibility is assumed by Richtek or its subsidiaries for its use; nor for any infringements of patents or other rights of third parties which may result from its use. No license is granted by implication or otherwise under any patent or patent rights of Richtek or its subsidiaries.

单击下面可查看定价，库存，交付和生命周期等信息

[>>Richtek\(台湾立锜\)](#)