

High Voltage 4-CH LED Driver

General Description

The RT8577A is an 4-CH LED driver capable of delivering 120mA for each channel. The RT8577A is a current mode boost converter with an adjustable switching frequency via the RT pin from 200kHz to 2.1MHz and a wide VIN range from 5.5V to 40V.

The PWM output voltage loop selects and regulates the LED pin with the highest voltage string to 0.6V, hence allowing voltage mismatches between LED strings. The RT8577A automatically detects and disconnects any unconnected and/or broken strings during operation from PWM loop to prevent V_{OUT} from over voltage. The 1.5% matched LED currents on all channels are simply programmed with a resistor. A very high contrast ratio true digital PWM dimming can be achieved by driving the PWM pin with a PWM signal.

When an abnormal situation (OVP/short/OTP) occurs, a status signal will be sent to the system to shut down the IC.

Ordering Information

RT8577A □ □

- Package Type
QW : WQFN-20L 5x5 (W-Type)
- Lead Plating System
G : Green (Halogen Free and Pb Free)

Note :

Richtek products are :

- ▶ RoHS compliant and compatible with the current requirements of IPC/JEDEC J-STD-020.
- ▶ Suitable for use in SnPb or Pb-free soldering processes.

Marking Information

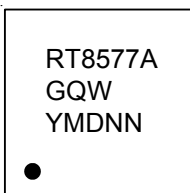

RT8577AGQW : Product Number
YMDNN : Date Code

Features

- Wide Input Supply Voltage Range : 5.5V to 40V
- Adjustable Boost Controller Switching Frequency from 200kHz to 2.1MHz
- Programmable Channel Current
- Channel Current Matching : ±1.5%
- External Dimming Control
- Boost MOSFET Over Current Protection
- Automatic LED Open/Short Protection to Avoid Output Over Voltage
- VCC Under Voltage Lockout
- Adjustable Over Voltage Protection
- Thermal Shutdown Protection
- Abnormal Status Indicator for OVP/Short/OTP Condition
- AEC-Q100 Grade 3 Certification
- RoHS Compliant and Halogen Free

Applications

- Automotive Infotainment
- LCD TV, Monitor Display Backlight
- LED Driver Application
- General Purpose Constant Current Source

Pin Configurations

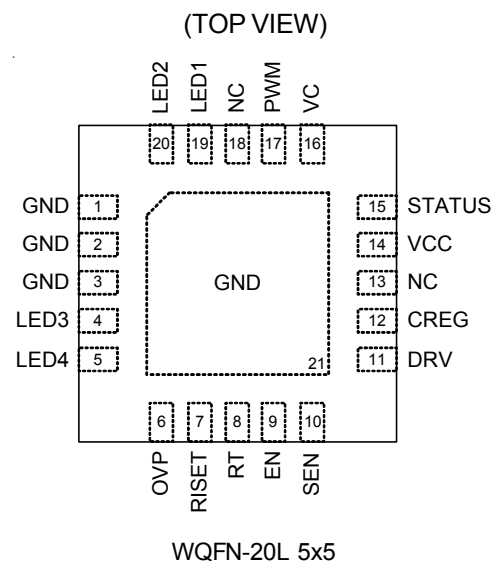

Functional Pin Description

Pin No.	Pin Name	Pin Function
1, 2, 3, 21 (Exposed pad)	GND	Ground. The exposed pad must be soldered to a large PCB and connected to GND for maximum power dissipation.
4, 5	LED4, LED3	Channel 3 and Channel 4 LED Current Sinks. Leave the pins unconnected if not used.
6	OVP	Over-Voltage Detection Input. The Boost converter turns off when V_{OVP} goes higher than 2V.
7	RISET	LED Current Set Pin. A resistor or a current from DAC on this pin programs the full LED current.
8	RT	Switching Frequency Set. Connect a resistor between RT and GND to set the boost converter switching frequency.
9	EN	Enable Control Input. When EN is pulled low, the chip will be shut down.
10	SEN	Current Sense Input. During normal operation, this pin senses the voltage across the external inductor current sensing resistor for peak current mode control and also to limit the inductor current during every switching cycle.
11	DRV	Boost Converter Power Switch Gate Output. This pin drives the external power N-MOSFET device.
12	CREG	Regulator Output for Chip Internal use Only. A 1 μ F capacitor should be placed on this pin to stabilize the 5V output of the internal regulator.
13, 18	NC	No Internal Connection.
14	VCC	Power Supply of the Chip. For good bypass, a low ESR capacitor close to the pin is required.
15	STATUS	Status Indicator Output. This pin will be pulled to low if fault happens.
16	VC	PWM Boost Converter Loop Compensation Node.
17	PWM	Dimming Control Input.
19	LED1	Channel 1 LED Current Sink, Leave this pin unconnected if it is not used.
20	LED2	Channel 2 LED Current Sink, Leave this pin unconnected if it is not used.

Function Block Diagram

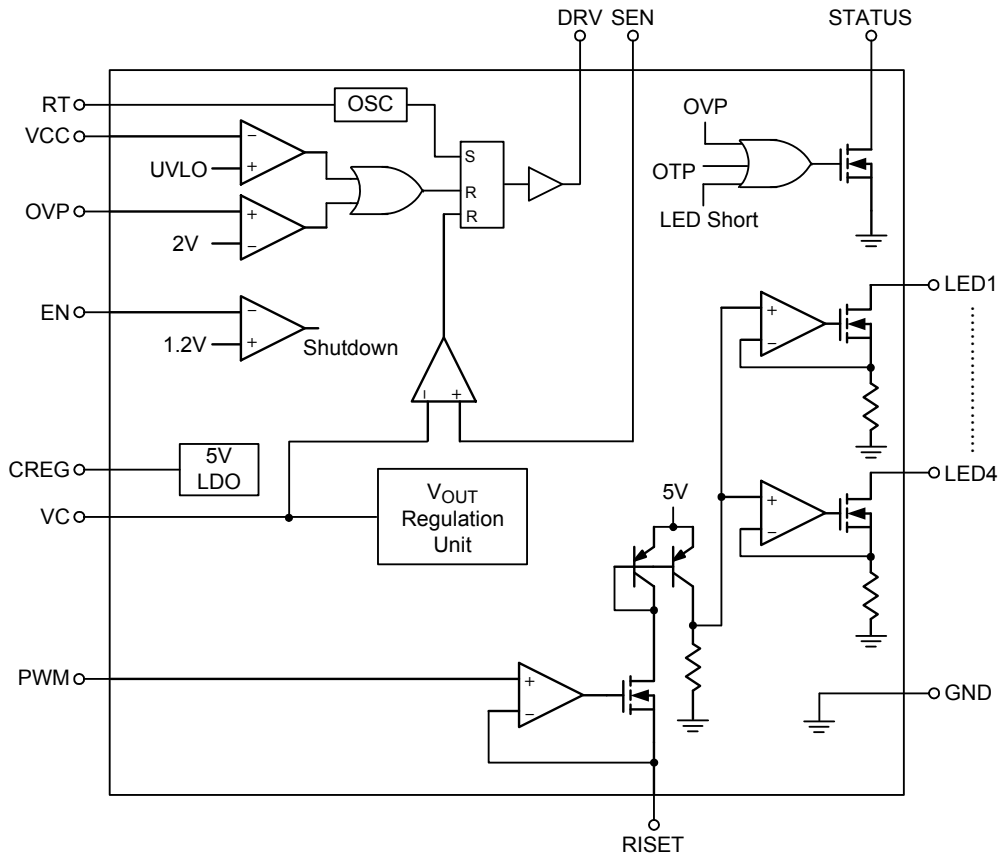

Operation

The RT8577A integrated a current-mode Boost PWM controller and 4 LED drivers. When EN and PWM are high and VIN is higher than the UVLO threshold voltage, the controller starts operation. In normal operation, the DRV pin turns high when the gate driver is set by the oscillator and the DRV pin turns low when the gate driver is reset by the current comparator. When the DRV pin turns high to turn on the external MOSFET, the inductor current will rise up. Once the SEN pin voltage reaches the level of the VC pin, the current comparator will reset the gate driver and turn off the MOSFET. The DRV pin is then set to high again by OSC and repeats in the next switching cycle. The oscillator frequency can be set by an external resistor at the RT pin.

The output voltage of the Boost converter supports LED current and regulation voltage at the LEDx pin. The LED current is set by an external resistor at the Riset pin. A PWM dimming function is provided to control the LED brightness through the PWM pin. If OVP, OTP or shorted LED happens, the STATUS pin will be pulled to low as a fault indicator.

Absolute Maximum Ratings (Note 1)

- Supply Voltage, VCC, STATUS ----- -0.3V to 45V
- LED1 to LED4 ----- -0.3V to 50V
- PWM, EN, DRV, SEN, VC, RT, CREG, OVP, Riset ----- -0.3V to 5.6V
- Power Dissipation, P_D @ T_A = 25°C
 - WQFN-20L 5x5 ----- 3.54W
- Package Thermal Resistance (Note 2)
 - WQFN-20L 5x5, θ_{JA} ----- 28.2°C/W
 - WQFN-20L 5x5, θ_{JC} ----- 7.1°C/W
- Junction Temperature ----- 150°C
- Lead Temperature (Soldering, 10 sec.) ----- 260°C
- Storage Temperature Range ----- -65°C to 150°C
- ESD Susceptibility (Note 3)
 - HBM (Human Body Model) ----- 2kV
 - MM (Machine Model) ----- 200V

Recommended Operating Conditions (Note 4)

- Supply Voltage, VCC ----- 5.5V to 40V
- LED1 to LED4 ----- 45V
- I_{LED1} to I_{LED4} ----- 20mA to 120mA
- Junction Temperature Range ----- -40°C to 125°C
- Ambient Temperature Range ----- -40°C to 85°C

Electrical Characteristics

(V_{CC} = 12V, T_A = 25°C, unless otherwise specified)

Parameter		Symbol	Test Conditions	Min	Typ	Max	Unit
Supply Voltage							
Supply Current		I _{VCC}	Switching Off	--	5	--	mA
Shutdown Current		I _{SHDN}	V _{EN} < 0.7V	--	10	--	μA
VDD LDO Output		V _{CREG}		4.5	5	5.5	V
VDD LDO Capability		I _{CREG}		30	--	--	mA
VCC UVLO Threshold		V _{UVLO}	VCC Rising	--	4.5	--	V
			Hysteresis	--	0.3	--	
EN Threshold Voltage	Logic-High	V _{ENH}		1.5	--	--	V
	Logic-Low	V _{ENL}		--	--	0.8	
LED Current Programming							
LED Current Accuracy			R _{iset} = 15kΩ, V _{PWM} > 1.2V	76	80	84	mA
LED Current Matching (Note5)			I _{LED} = 80mA I _{LED} = (20mA, 120mA) Note6 $\frac{I_{LEDx} - I_{LED_AVE}}{I_{LED_AVE}} \times 100\%$	--	±1.5	±3	%

Parameter	Symbol	Test Conditions	Min	Typ	Max	Unit
LED1 to LED4 Regulation Voltage		I _{LED} = 80mA	--	0.86	--	V
V _{LED} Threshold		No Connection	--	0.1	--	V
RISET Pin Voltage			--	1.2	--	V
Dimming						
PWM Threshold Voltage	Logic-High	V _{PWMH}	1.2	--	--	V
	Logic-Low	V _{PWML}	--	--	0.52	
PWM Boost Controller						
Switching Frequency	f _{SW}	R _{RT} = 20kΩ (Note 5)	1.8	2.1	2.4	MHz
		R _{RT} = Open	--	200	--	kHz
Minimum On Time (Note 5)	t _{ON}	Working	--	40	60	ns
Maximum Duty Cycle	D _{max}		80	--	--	%
SEN Current Sense Limit (Note 5)		Input Current Limit	0.3	0.5	0.6	V
Gate Driver Source			1.5	2.5	3	A
Gate Driver Sink			2.5	3	4	A
OVP, SCP, OTP						
OVP Threshold (Note 5)	V _{OVP}		1.9	2	2.1	V
SCP Threshold	V _{SCP}	LED1 to LED4	--	7	--	V
Thermal Shutdown Temperature	T _{SD}	Lockout Temperature Point	--	150	--	°C
Thermal Shutdown Hysteresis	ΔT _{SD}	Resume Temperature Point	--	20	--	°C
STATUS Low Voltage	V _{STATUS}	Open Drain at 10mA	--	--	0.5	V

Note 1. Stresses beyond those listed “Absolute Maximum Ratings” may cause permanent damage to the device. These are stress ratings only, and functional operation of the device at these or any other conditions beyond those indicated in the operational sections of the specifications is not implied. Exposure to absolute maximum rating conditions may affect device reliability.

Note 2. θ_{JA} is measured at T_A = 25°C on a high effective thermal conductivity four-layer test board per JEDEC 51-7. θ_{JC} is measured at the exposed pad of the package.

Note 3. Devices are ESD sensitive. Handling precaution is recommended.

Note 4. The device is not guaranteed to function outside its operating conditions.

Note 5. Electrical items with mark indicate performance guaranteed by design with correlation data (T_A = -40°C to 85°C)

Note 6. The LED current matching at 20mA and 120mA is guaranteed by design and not production tested.

Typical Application Circuit

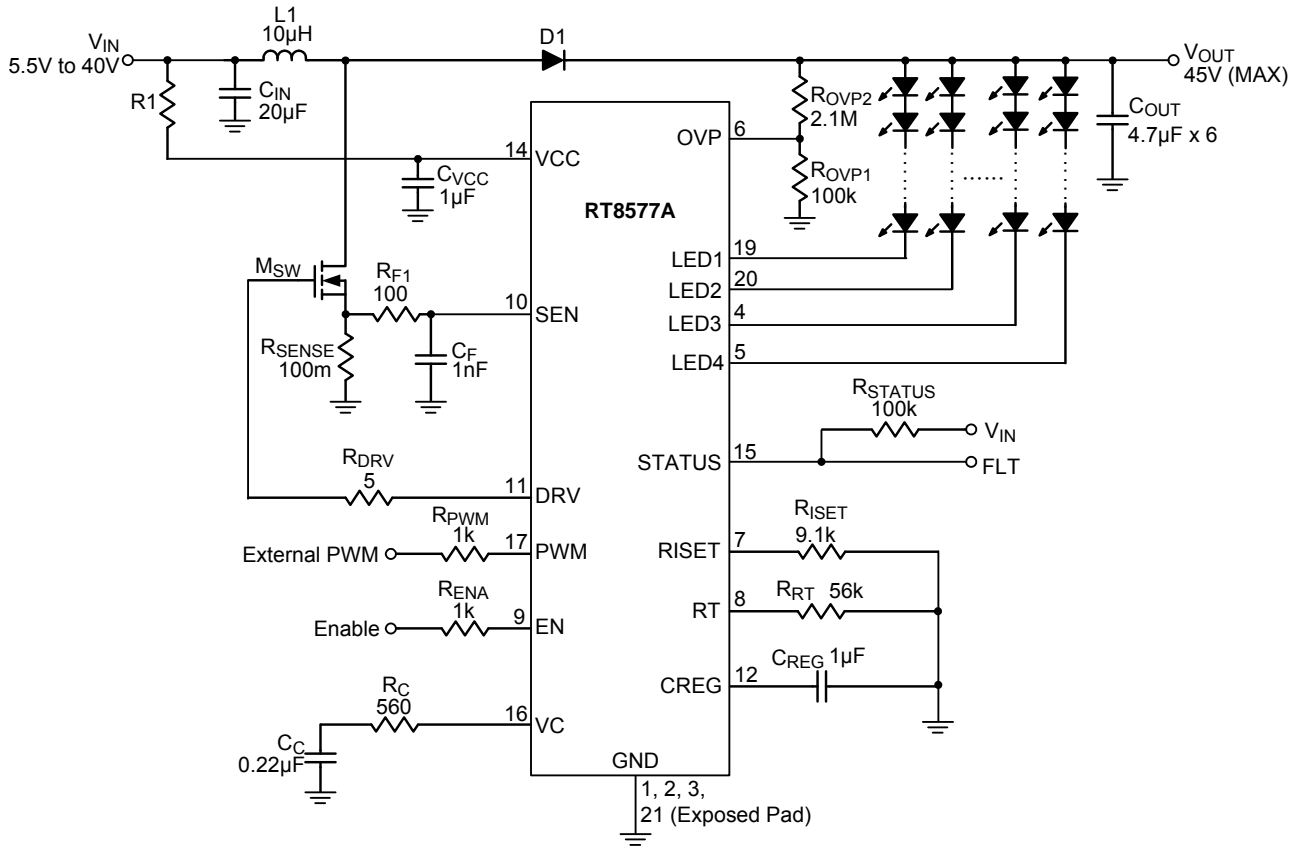

I_{LED} (Note 6)	R_{SET}
120mA	10k Ω
80mA	15k Ω
20mA	68k Ω

Timing Diagram

Power On/Off Sequence

LED driver is without power sequence concern. Mode1, Mode2 and Mode3 are different power sequences respectively. There is no concern in the above condition.

Mode1 : Delay Time of PWM vs V_{OUT}

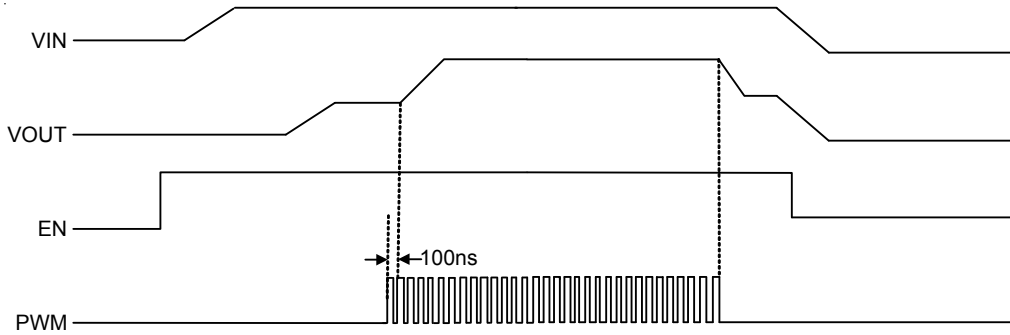

Mode2 : Delay Time of EN vs V_{OUT}

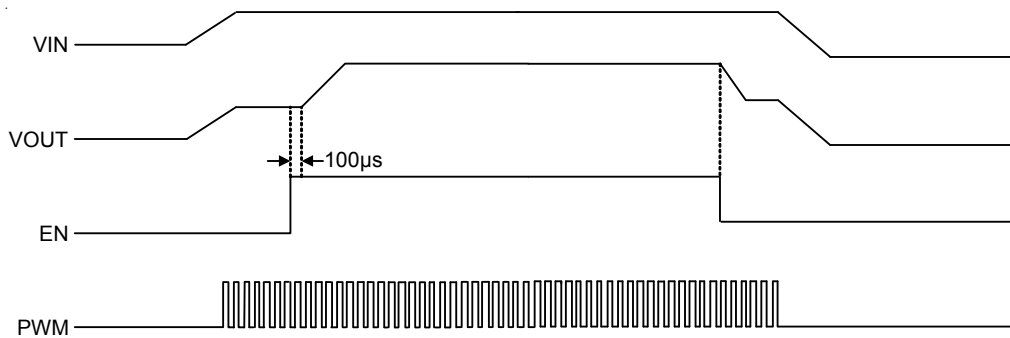

Mode3 : Delay Time of V_{IN} vs V_{OUT}

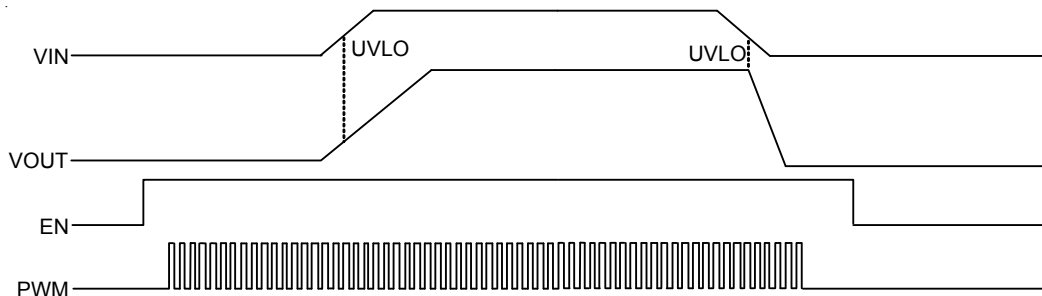
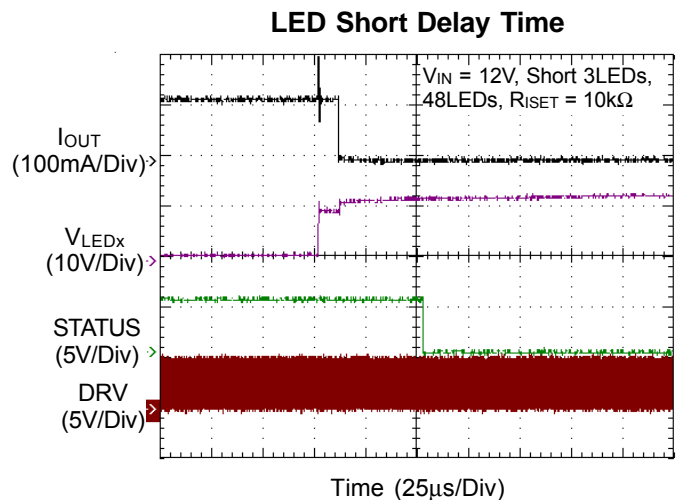
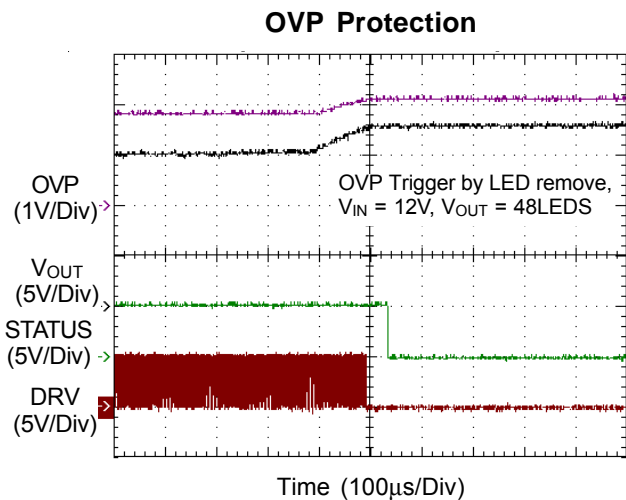
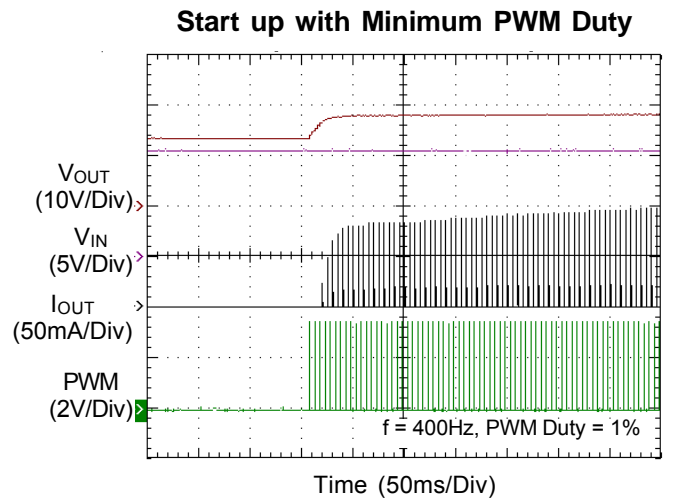
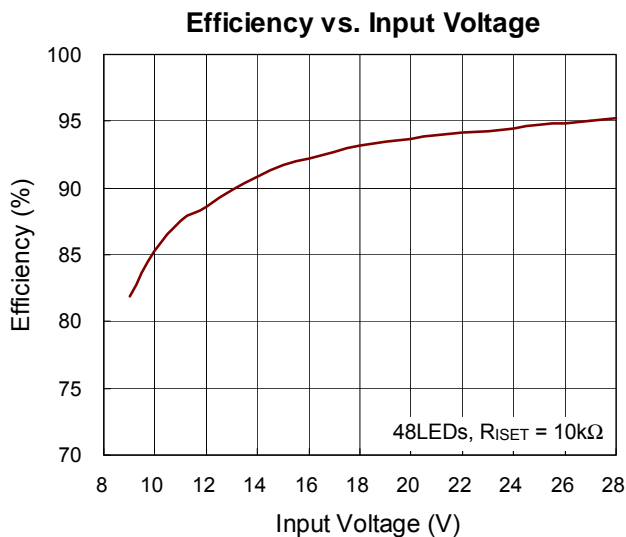
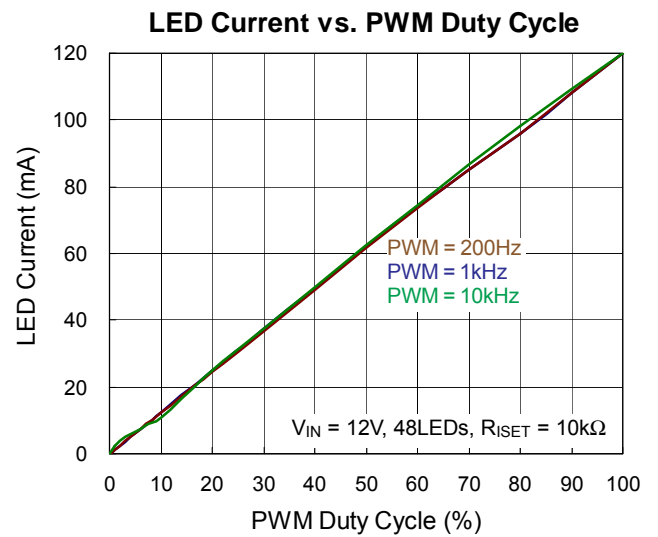
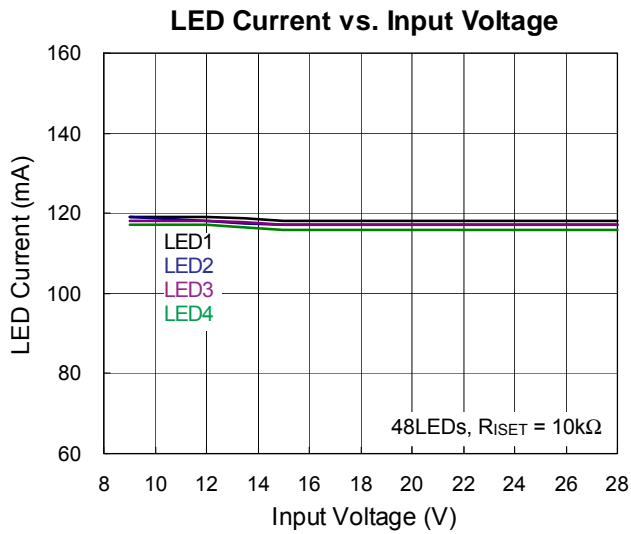
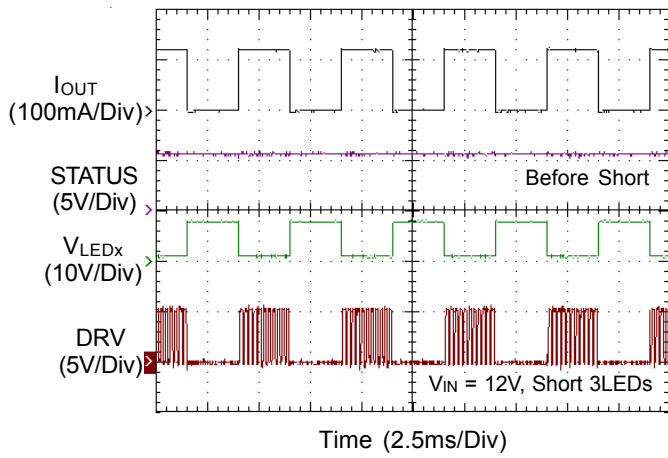

Figure 1. Power On/Off Sequence

Typical Operating Characteristics



LED Short Protection



LED Short Protection

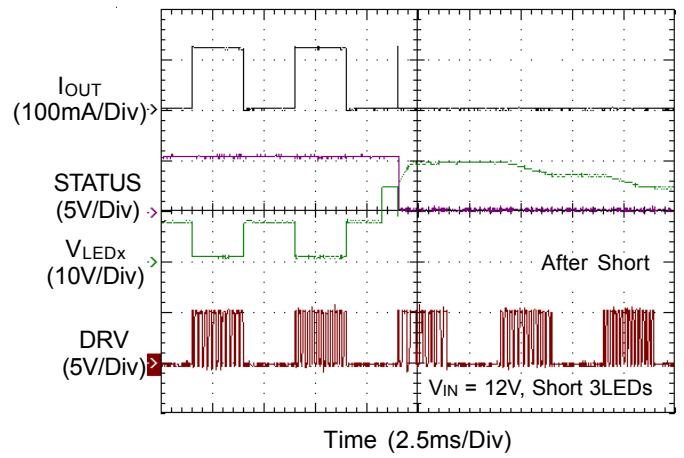

Power On from EN

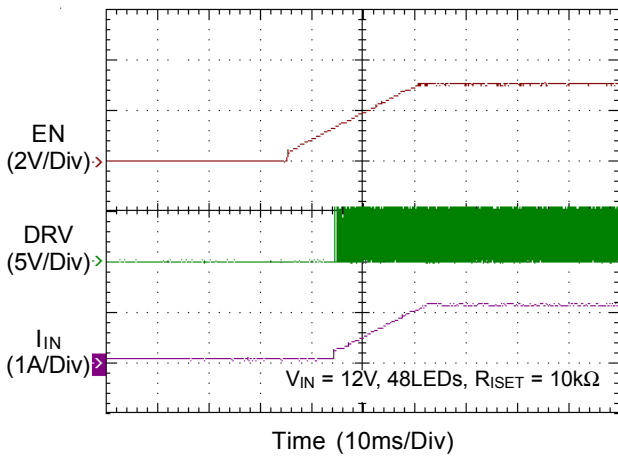

Power Off from EN

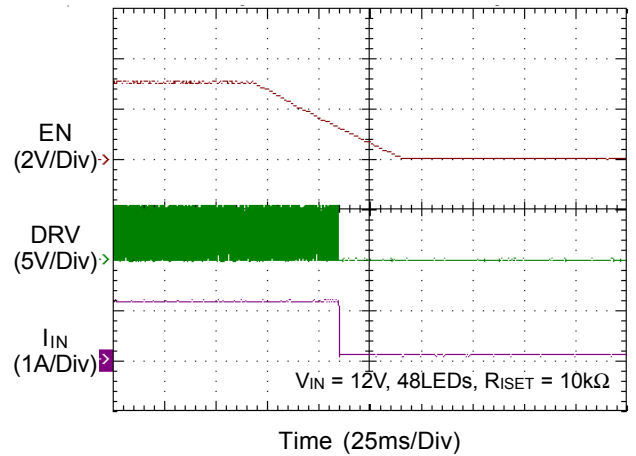

Power On from VIN

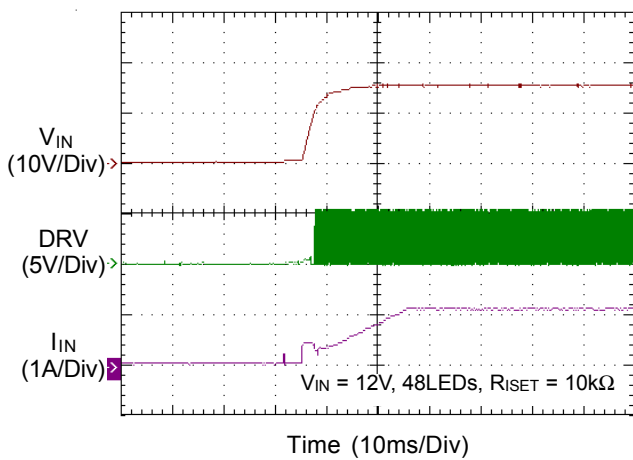

Power Off from VIN

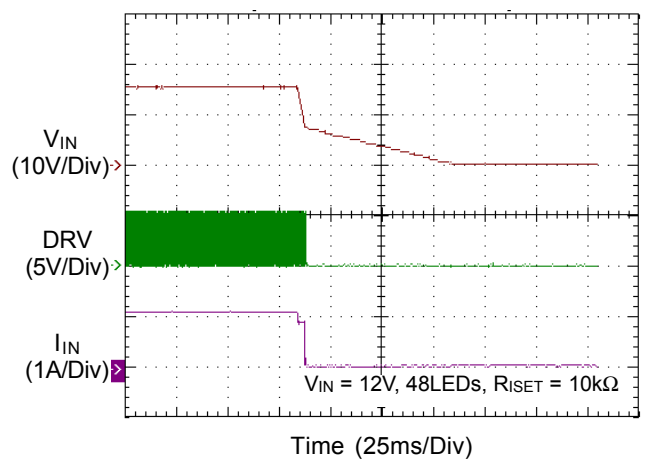

Power On from PWM

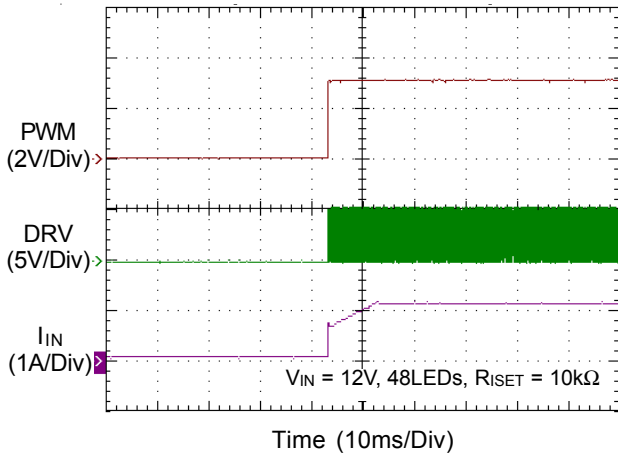

Power Off from PWM

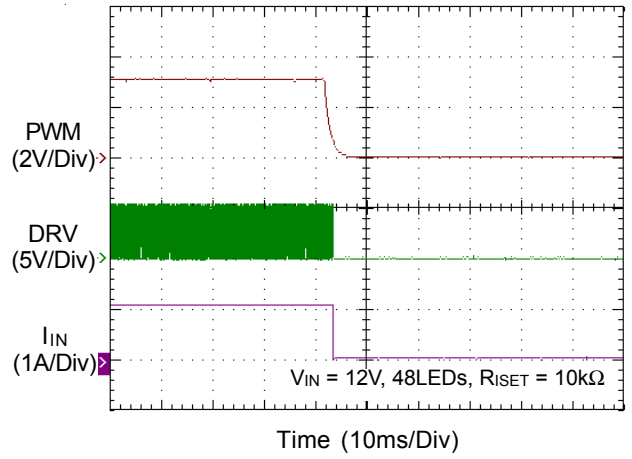

Application information

The RT8577A is an 4-CH driver controller that delivers well matched LED current to each channel of LED strings. The external N-MOSFET current source will accommodate the power dissipation difference among channels resulting from the forward voltage difference between the LED strings. With high speed current source N-MOSFET drivers, the RT8577A features highly accurate current matching, while also providing very fast turn-on and turn-off times. This allows a very narrow minimum on or off pulse. The RT8577A integrates adjustable switching frequency and provides circuitry for over temperature, over voltage, under voltage and current limit protection.

Compensation

The regulator loop can be compensated by adjusting the external components connected to the VC pin. The VC pin is the output of the internal error amplifier. The compensation capacitor will adjust the integrator zero to maintain stability and the resistor value will adjust the frequency integrator gain for fast transient response. Typical values of the compensation components are $R_C = 560\Omega$, $C_C = 0.22\mu F$.

LED Connection

The RT8577A equips 4-CH LED drivers and each channel supports up to 15 LEDs. The LED strings are connected from the output of the boost converter to pin LEDx (x = 1 to 4) respectively. If one of the LED channel is not in use, the LED pin should be opened directly.

Setting and Regulation of LED current

The LED current can be calculated by the following equation :

$$I_{LED} \cong \frac{1200}{R_{ISET}} (40mA < I_{LED} \leq 120mA)$$

$$I_{LED} \cong \frac{1360}{R_{ISET}} (20mA < I_{LED} \leq 40mA)$$

where R_{ISET} is the resistor between the RISET pin and GND. This setting is the reference for the LED current at pin LEDx and represents the sensed LED current for each string. The DC/DC converter regulates the LED current according to the setting.

Over Voltage Protection

The RT8577A integrates Over Voltage Protection (OVP) . When the voltage at the OVP pin rises above the threshold voltage of approximately 2V, the internal switch will be turned off and STATUS pin will be pulled to low. The internal switch will be turned on again once the voltage at the OVP pin returns to normal range. The output voltage can be clamped at a certain voltage level and can be calculated by the following equations :

$$V_{OUT(OVP)} = V_{OVP} \times \left(1 + \frac{R_{OVP2}}{R_{OVP1}} \right)$$

where R_{OVP1} and R_{OVP2} are the resistors in the resistive voltage divider connected to the OVP pin. If at least one string is in normal operation, the controller will automatically ignore the open strings and continue to regulate the current for the strings in normal operation. Suggested value for R_{OVP2} is up to 3.6M Ω to prevent loading effect.

LED Short Circuit Protection

The RT8577A integrates LED Short Circuit Protection (SCP). If one of the LED1 to LED4 pin voltages exceeds a threshold of approximately 7V during normal operation, the STATUS pin will be pulled low for a fault signal.

STATUS

The RT8577A provides a fault status indicator with an open drain STATUS pin. If fault condition (LED Short/OVP/OTP) occurs, the STATUS will be reset after V_{IN} or EN is re-applied.

Setting the Switching Frequency

The RT8577A switching frequency is programmable from 200kHz to 2.1MHz by adjusting the oscillator resistor, R_{RT} . The switching frequency can be calculated by the following equation :

$$f_{SW} \cong 200k + \frac{38 \times 10^9}{R_{RT}}$$

Current Limit Protection

The RT8577A can sense the R_{SENSE} voltage between the SEN pin and GND to achieve over current protection. The boost converter senses the inductor current during the on period. The duty cycle depends on the current signal and internal slope compensation compared with the error signal. The external switch will be turned off when the current signal is larger than the internal slope compensation. In the off period, the inductor current will decrease until the internal switch is turned on by the oscillator. The current limit value can be calculated by the following equation :

$$\text{Current Limit (A)} \cong \frac{0.5V}{R_{SENSE}}$$

Brightness Control

The RT8577A features a digital dimming control scheme. A very high contrast ratio true digital PWM dimming is achieved by driving the PWM pin with a PWM signal. The recommended PWM frequency is 100Hz to 10kHz, but the LED current cannot be 100% proportional to duty cycle, especially for high frequency and low duty ratio because of physical limitation caused by inductor rising time. Please refer to Table 1.

Table 1.

Dimming Frequency (Hz)	Duty (Min.)	Duty (Max.)
$100 < f_{PWM} \leq 500$	0.2%	100%
$500 < f_{PWM} \leq 1k$	0.4%	100%
$1k < f_{PWM} \leq 2k$	0.8%	100%
$2k < f_{PWM} \leq 5k$	1.5%	100%
$5k < f_{PWM} \leq 10k$	3%	100%

Note : The minimum duty in Table 1 is based on the application circuit and does not consider the deviation of current linearity.

Over Temperature Protection

The RT8577A has over temperature protection function to prevent the IC from overheating due to excessive power dissipation. The IC will shut down and the STATUS pin will be pulled low when junction temperature exceeds 150°C. Main converter starts switching after junction temperature cools down by approximately 20°C.

Inductor Selection

The value of the inductance, L, can be approximated by the following equation, where the transition is from Discontinuous Conduction Mode (DCM) to Continuous Conduction Mode (CCM) :

$$L = \frac{D \times (1-D)^2 \times V_{OUT}}{2 \times f \times I_{OUT}}$$

The duty cycle can be calculated as the following equation :

$$D = \frac{V_{OUT} - V_{IN}}{V_{OUT}}$$

where V_{OUT} is the maximum output voltage, V_{IN} is the minimum input voltage, f is the operating frequency, and I_{OUT} is the sum of current from all LED strings.

The boost converter operates in DCM over the entire input voltage range when the inductor value is less than this value, L. With an inductance greater than L, the converter operates in CCM at the minimum input voltage and may be discontinuous at higher voltages.

The inductor must be selected with a saturated current rating that is greater than the peak current as provided by the following equation :

$$I_{PEAK} = \frac{V_{OUT} \times I_{OUT}}{\eta \times V_{IN}} + \frac{V_{IN} \times D \times T}{2 \times L}$$

where η is the efficiency of the power converter.

Diode Selection

Schottky diodes are recommended for most applications because of their fast recovery time and low forward voltage. Power dissipation, reverse voltage rating, and pulsating peak current are important parameters for consideration when making a Schottky diode selection. Make sure that the diode's peak current rating exceeds I_{PEAK} and reverse voltage rating exceeds the maximum output voltage.

Capacitor Selection

The input capacitor reduces current spikes from the input supply and minimizes noise injection to the converter. For general applications, six 4.7 μ F ceramic capacitors are sufficient. A value higher or lower may be used depending on the noise level from the input supply and the input current to the converter.

It is recommended to choose a ceramic capacitor based on the output voltage ripple requirements. The minimum value of the output capacitor, C_{OUT} , can be calculated by the following equation :

$$C_{OUT} = \frac{I_{OUT} \times D}{\Delta V_{OUT} \times f}$$

where ΔV_{OUT} is the peak-to-peak ripple voltage at the output.

Thermal Considerations

For continuous operation, do not exceed absolute maximum junction temperature. The maximum power dissipation depends on the thermal resistance of the IC package, PCB layout, rate of surrounding airflow, and difference between junction and ambient temperature. The maximum power dissipation can be calculated by the following formula :

$$P_{D(MAX)} = (T_{J(MAX)} - T_A) / \theta_{JA}$$

where $T_{J(MAX)}$ is the maximum junction temperature, T_A is the ambient temperature, and θ_{JA} is the junction to ambient thermal resistance.

For recommended operating condition specifications, the maximum junction temperature is 125°C and T_A is the ambient temperature. The junction to ambient thermal resistance, θ_{JA} , is layout dependent. For WQFN-20L 5x5

packages, the thermal resistance, θ_{JA} , is 28.2°C/W on a standard JEDEC 51-7 four-layer thermal test board. The maximum power dissipation at $T_A = 25^\circ\text{C}$ can be calculated by the following formula :

$$P_{D(MAX)} = (125^\circ\text{C} - 25^\circ\text{C}) / (28.2^\circ\text{C/W}) = 3.54\text{W for WQFN-20L 5x5 package}$$

The maximum power dissipation depends on the operating ambient temperature for fixed $T_{J(MAX)}$ and thermal resistance, θ_{JA} . The derating curve in Figure 2 allows the designer to see the effect of rising ambient temperature on the maximum power dissipation.

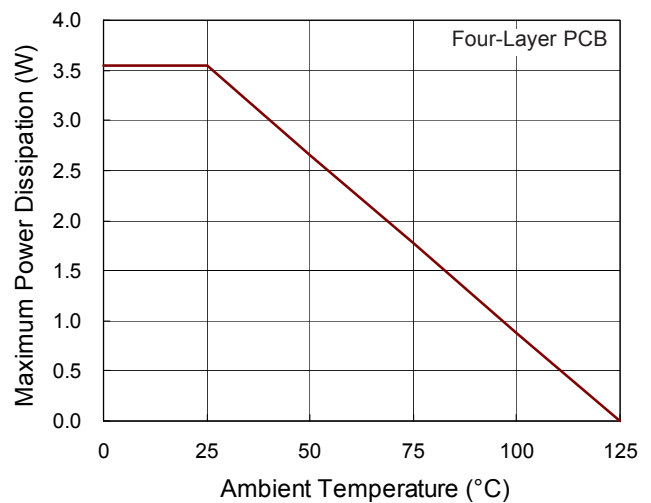

Figure 2. Derating Curve of Maximum Power Dissipation

Layout Considerations

Careful PCB layout is very important for designing switching power converter circuits. The following layout guidelines should be strictly followed for best performance of the RT8577A.

- ▶ The power components L1, D1, C_{IN} , C_{OUT} must be placed as close as possible to the IC to reduce current loop. The PCB trace between power components must be as short and wide as possible.
- ▶ The compensation circuit should be kept away from the power loops and shielded with a ground trace to prevent any noise coupling. Place the compensation components, R_C and C_C , as close as possible to pin 9.
- ▶ The exposed pad of the chip should be connected to ground plane for thermal consideration.

OVP Protection

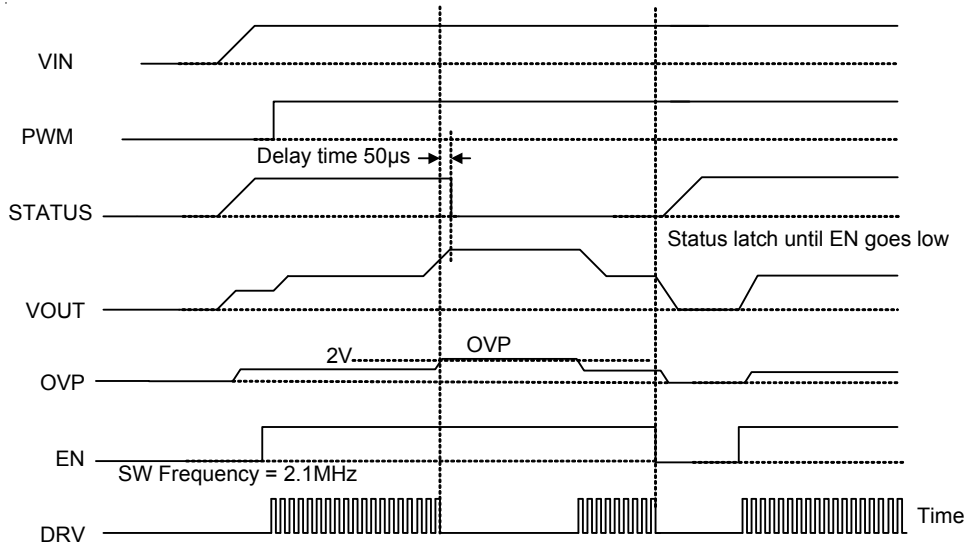

Short Protection

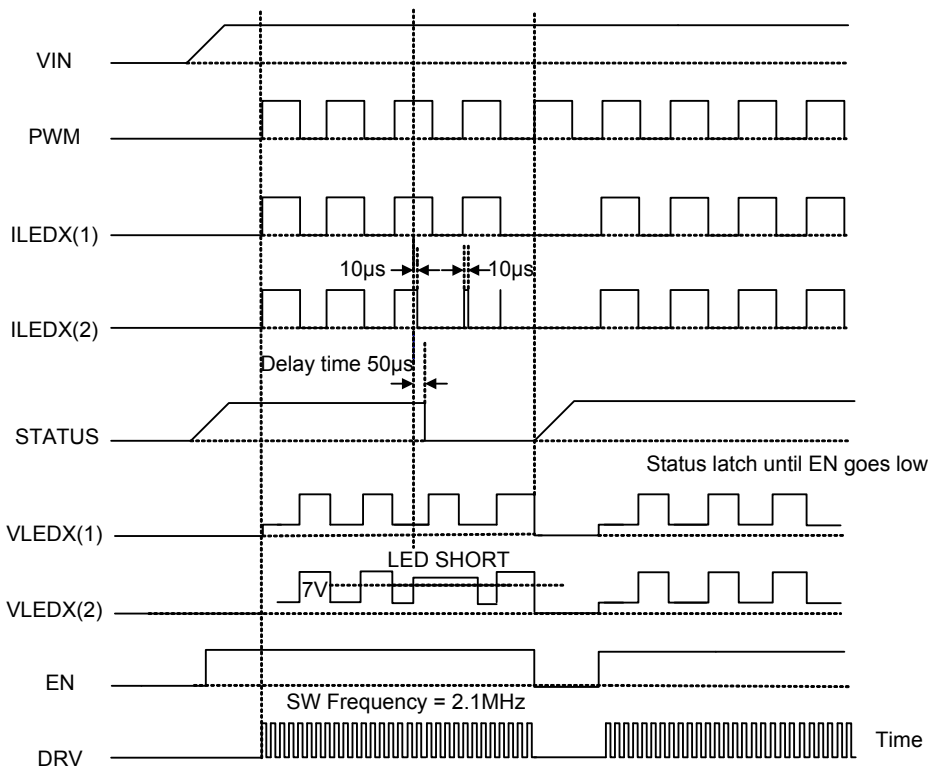

OTP Function

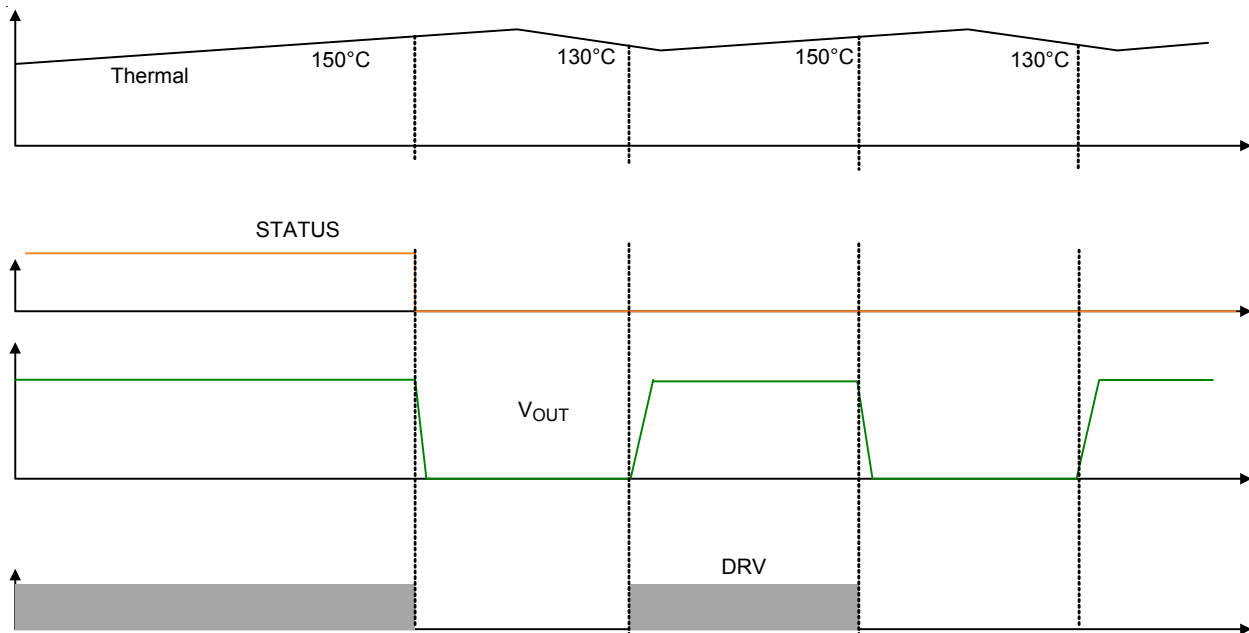

Protection Functions

	Description	Protection	Behavior
LED Short	Detect V_{LEDx} voltage. Triggered if $V_{LEDx} > 7V$.	V	If one of LED1 to LED4 pin voltages exceeds a threshold of approximately 7V during normal operation, the STATUS pin will be pulled to low for a fault signal. Internal switching does not stop.
OVP	Use OVP pin voltage for detection. Triggered if OVP pin voltage $> 2V$.	V	The internal switch will be turned off and STATUS pin will be pulled to low. The Internal switch will be turned on again once the voltage at the OVP pin returns to normal range.
OTP	Triggered if $T_J > 150^{\circ}C$	V	The IC will shut down and the STATUS pin will be pulled to low when junction temperature exceeds 150°C and IC returns to normal operation when temperature falls to 130°C.
Fault Indicator	STATUS pin is used as fault indicator. Fault and pull low.	V	If fault condition (LED short, OVP or OTP) occurs, the STATUS pin will be pulled to low. It will be reset after VIN or EN is re-applied.

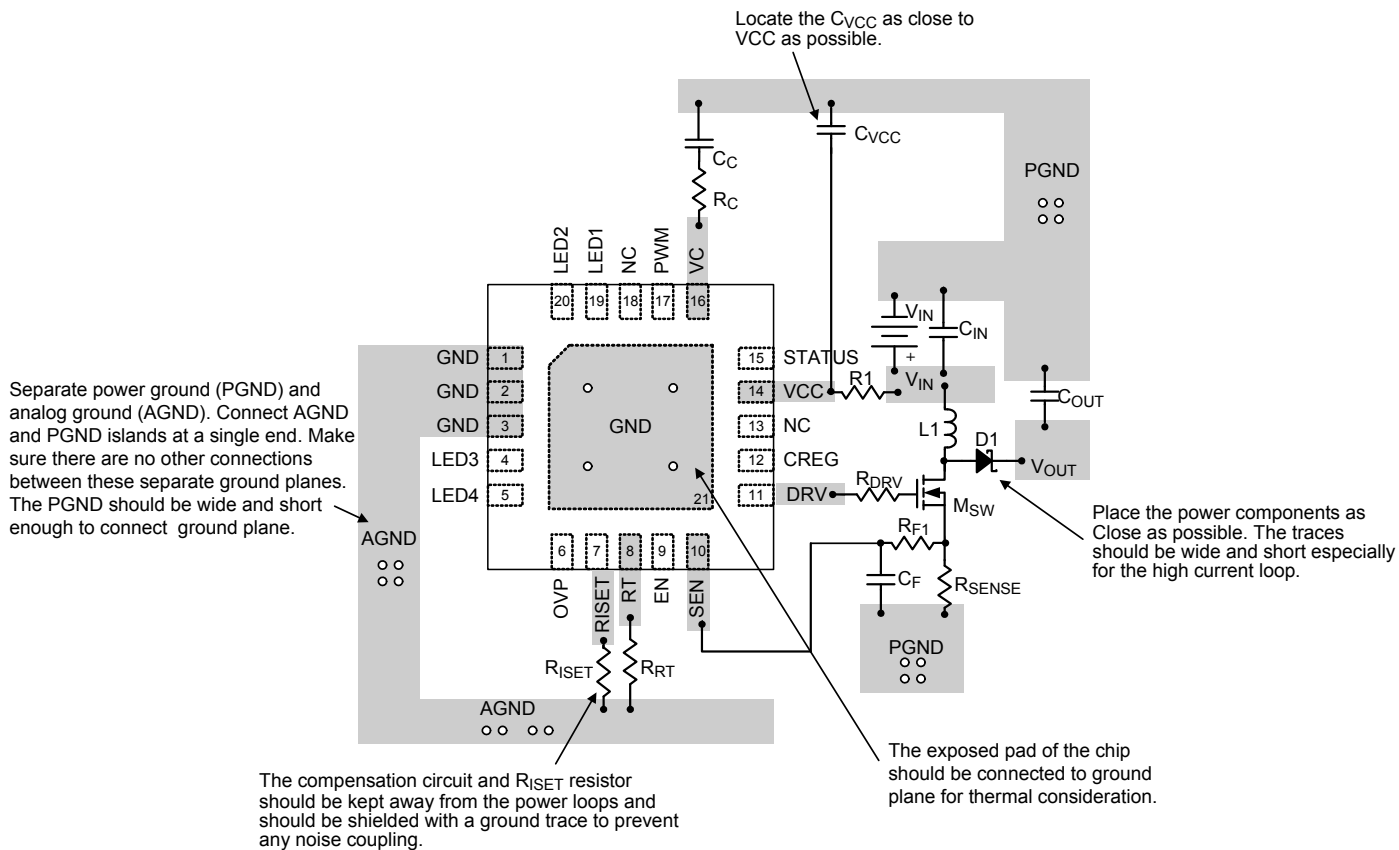
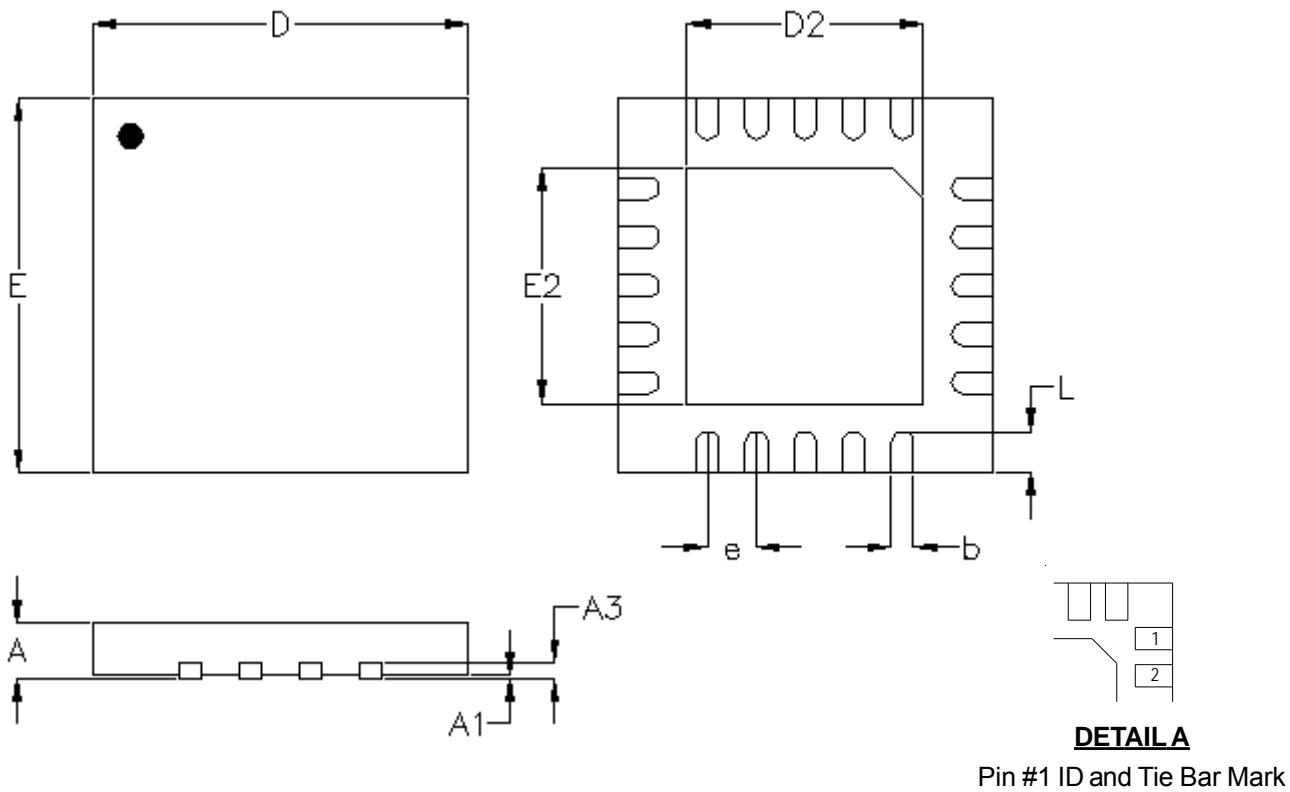

Figure 3. PCB Layout Guide

Outline Dimension



Symbol	Dimensions In Millimeters		Dimensions In Inches	
	Min.	Max.	Min.	Max.
A	0.700	0.800	0.028	0.031
A1	0.000	0.050	0.000	0.002
A3	0.175	0.250	0.007	0.010
b	0.250	0.350	0.010	0.014
D	4.900	5.100	0.193	0.201
D2	3.100	3.200	0.122	0.126
E	4.900	5.100	0.193	0.201
E2	3.100	3.200	0.122	0.126
e	0.650		0.026	
L	0.500	0.600	0.020	0.024

W-Type 20L QFN 5x5 Package

Richtek Technology Corporation

14F, No. 8, Tai Yuen 1st Street, Chupei City

Hsinchu, Taiwan, R.O.C.

Tel: (8863)5526789

Richtek products are sold by description only. Richtek reserves the right to change the circuitry and/or specifications without notice at any time. Customers should obtain the latest relevant information and data sheets before placing orders and should verify that such information is current and complete. Richtek cannot assume responsibility for use of any circuitry other than circuitry entirely embodied in a Richtek product. Information furnished by Richtek is believed to be accurate and reliable. However, no responsibility is assumed by Richtek or its subsidiaries for its use; nor for any infringements of patents or other rights of third parties which may result from its use. No license is granted by implication or otherwise under any patent or patent rights of Richtek or its subsidiaries.

www.richtek.com

DS8577A-01 December 2015

单击下面可查看定价，库存，交付和生命周期等信息

[>>Richtek\(台湾立锜\)](#)