

## 4+1 CH Power Management IC

### General Description

The RT9953 is a complete power supply solution for digital still cameras and other handheld devices. The RT9953 is a multi-CH power management IC including one synchronous step-up DC/DC converter, one selectable synchronous step-up/step-down DC/DC converter, two synchronous step-down DC/DC converters, and one low dropout linear regulator.

The RT9953 is designed to fulfill the applications for DSC as follows :

CH1 is a synchronous step-up output for motor or DSC system I/O power

CH2 is a selectable synchronous step-up/step-down output for motor or DSC system I/O power

CH3 and CH4 are synchronous step-down outputs for DSP core and memory power supply

CH5 is a 500mA, low dropout, low noise linear regulator with soft-start function.

The RT9953 is designed to support Li+ and 2AA battery applications. The selectable step-up/step-down converter can be set by SEL pin. For the synchronous step-up and step down converters, the efficiency can be up to 95%.

The RT9953 provides over current protection, thermal shutdown protection, over voltage and under voltage protection to achieve complete protection. The RT9953 is available in the WQFN-24L 4x4 package.

### Ordering Information

RT9953 □ □

- Package Type  
QW : WQFN-24L 4x4 (W-Type)
- Lead Plating System  
G : Green (Halogen Free and Pb Free)

Note :

Richtek products are :

- ▶ RoHS compliant and compatible with the current requirements of IPC/JEDEC J-STD-020.
- ▶ Suitable for use in SnPb or Pb-free soldering processes.

### Features

- One Synchronous Step-Up/Step-Down Selectable Converter
- Support 2AA or Li-ion Battery Applications
- Internal Soft-Start Control
- 4 CHs with Internal Compensation
- Power Switches Integrated
- Up to 95% Efficiency
- 100% (max) Duty Cycle for Step-Down Converter
- Adjustable Output Voltage
- Fixed 1MHz Switching Frequency
- LDO Works with Low-ESR Ceramic Capacitors
- Fast Line/Load Transient Response
- High PSRR Linear Regulator
- RoHS Compliant and Halogen Free

### Applications

- CMOS Digital Still Camera
- CMOS DV
- Portable Devices

### Pin Configurations

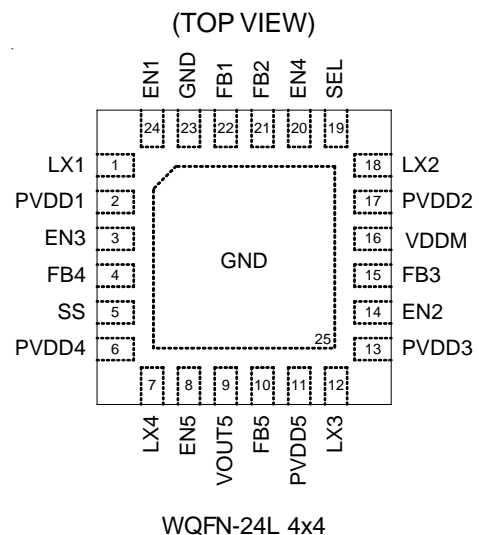

### Marking Information

For marking information, contact our sales representative directly or through a Richtek distributor located in your area.

## Typical Application Circuit

For 2AA

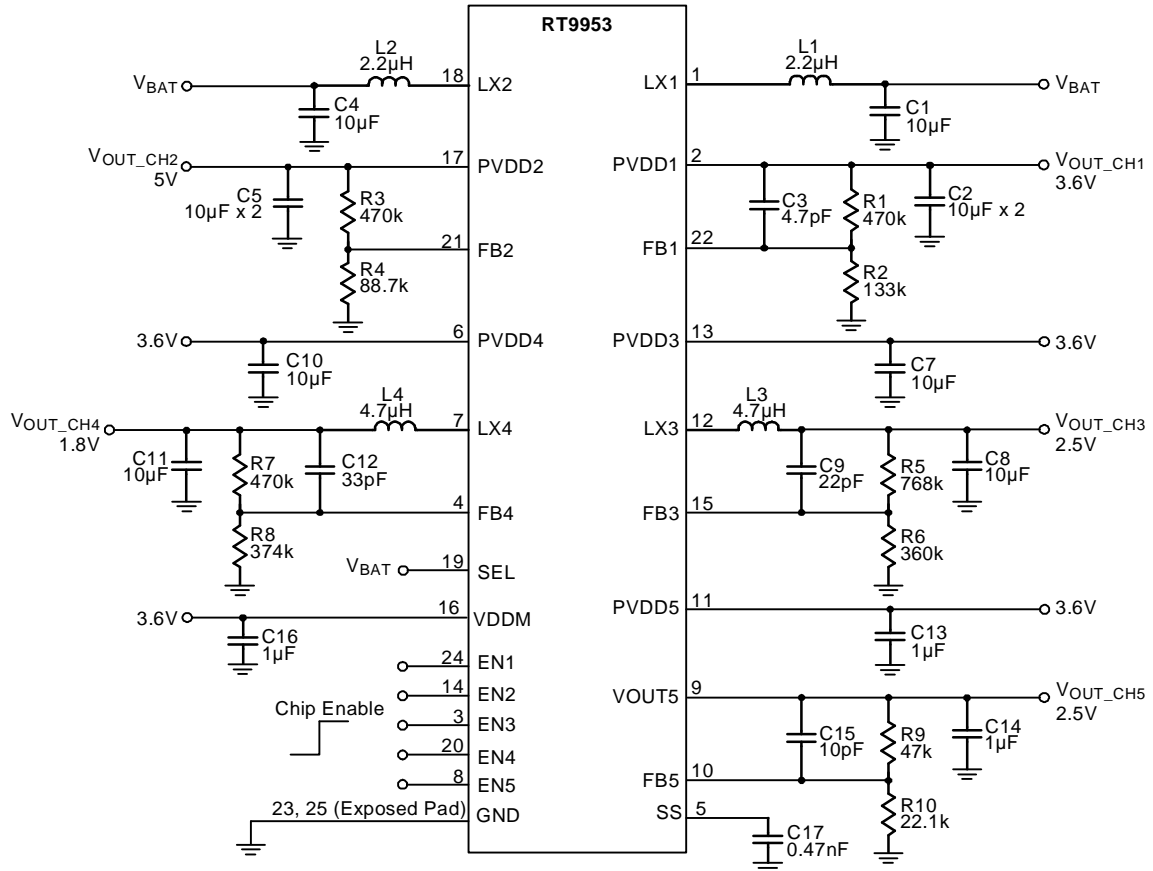

For Li-ion

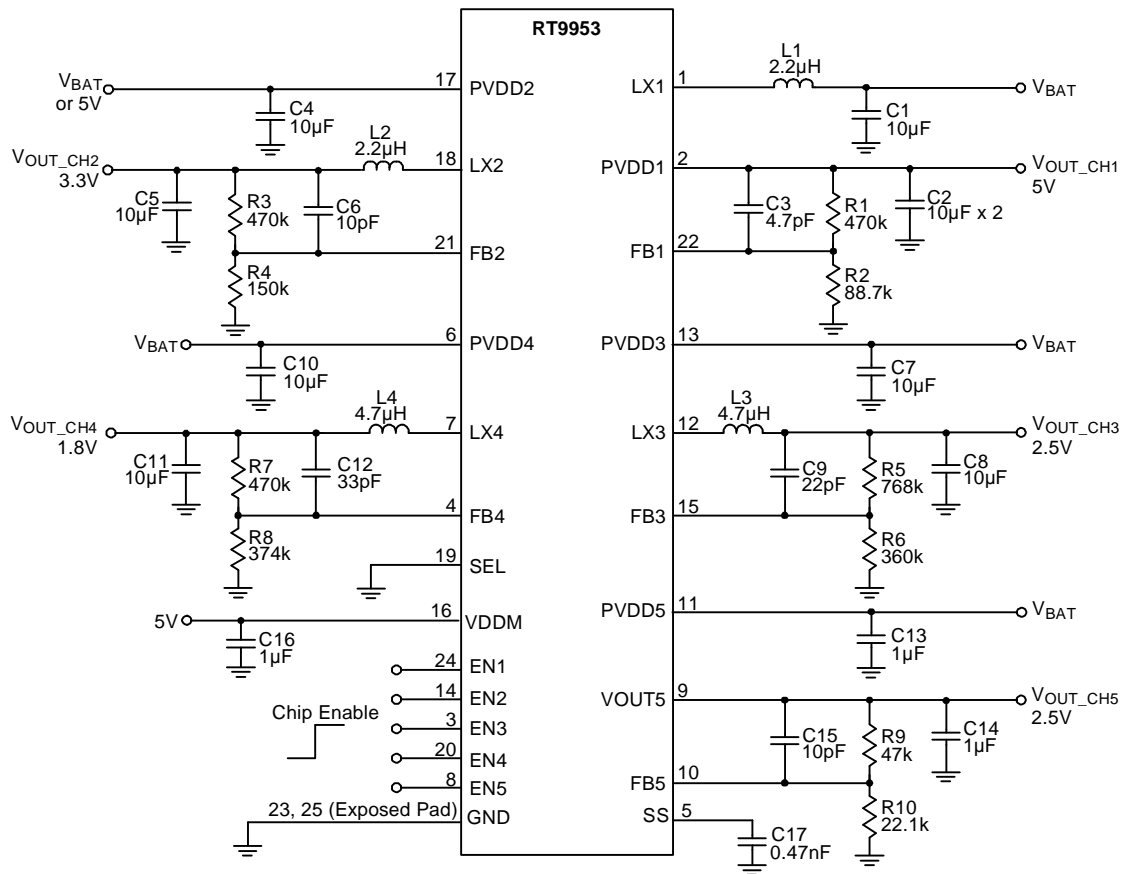

Table 1. Recommended Components for the Typical Application Circuit

Channel	CH3						
Formula	$V_{OUT\_CH3} = (1+R5/R6) \times 0.8$						
$V_{OUT\_CH3}$ (V)	3.3	2.5	1.8	1.5	1.3	1.2	1.0
L3 (mH)	4.7	4.7	4.7	4.7	4.7	4.7	4.7
R5 (kW)	86.6	768	470	330	237	187	23.2
R6 (kW)	27.4	360	374	374	374	374	93.1
C9 (pF)	22	22	33	47	68	82	47
C8 (mF)	10	10	10	10	10	10	10

Channel	CH4						
Application	$V_{OUT\_CH4} = (1+R7/R8) \times 0.8$						
$V_{OUT\_CH4}$ (V)	3.3	2.5	1.8	1.5	1.3	1.2	1.0
L4 (mH)	4.7	4.7	4.7	4.7	4.7	4.7	4.7
R7 (kW)	86.6	768	470	330	237	187	23.2
R8 (kW)	27.4	360	374	374	374	374	93.1
C12 (pF)	22	22	33	47	68	82	47
C11 (mF)	10	10	10	10	10	10	10

Channel	CH5
Formula	$V_{OUT\_CH5} = (1+R9/R10) \times 0.8$
$V_{OUT\_CH5}$ (V)	2.5
R9 (kW)	47
R10 (kW)	22.1
C15 (pF)	10
C14 (mF)	1

**Functional Pin Description**

Pin No.	Pin Name	Pin Function
1	LX1	Switch Node of CH1. High impedance in shutdown mode.
2	PVDD1	Power Input of CH1.
3	EN3	Enable Control Input of CH3.
4	FB4	Feedback Input of CH4. High impedance in shutdown mode.
5	SS	Soft-Start Control Input.
6	PVDD4	Power Input of CH4.
7	LX4	Switch Node of CH7. High impedance in shutdown mode.
8	EN5	Enable Control Input of CH5.
9	VOUT5	Output Voltage of CH5.
10	FB5	Feedback Input of CH5. High impedance in shutdown mode.
11	PVDD5	Power Input of CH5.
12	LX3	Switch Node of CH3. High impedance in shutdown mode.
13	PVDD3	Power Input of CH3.
14	EN2	Enable Control Input of CH2.
15	FB3	Feedback Input of CH3. High impedance in shutdown mode.
16	VDDM	Analog Power Input.
17	PVDD2	Power Input of CH2.
18	LX2	Switch Node of CH2. High impedance in shutdown mode.
19	SEL	Selection Input for CH2 step-up or step-down operation mode. Logic state can not be changed during operation.
20	EN4	Enable Control Input of CH4.
21	FB2	Feedback Input of CH2. High impedance in shutdown mode.
22	FB1	Feedback Input of CH1. High impedance in shutdown mode.
23, 25 (Exposed Pad)	GND	Ground Pin. The exposed pad must be soldered to a large PCB and connected to GND for maximum thermal dissipation.
24	EN1	Enable Control Input of CH1.

Function Block Diagram

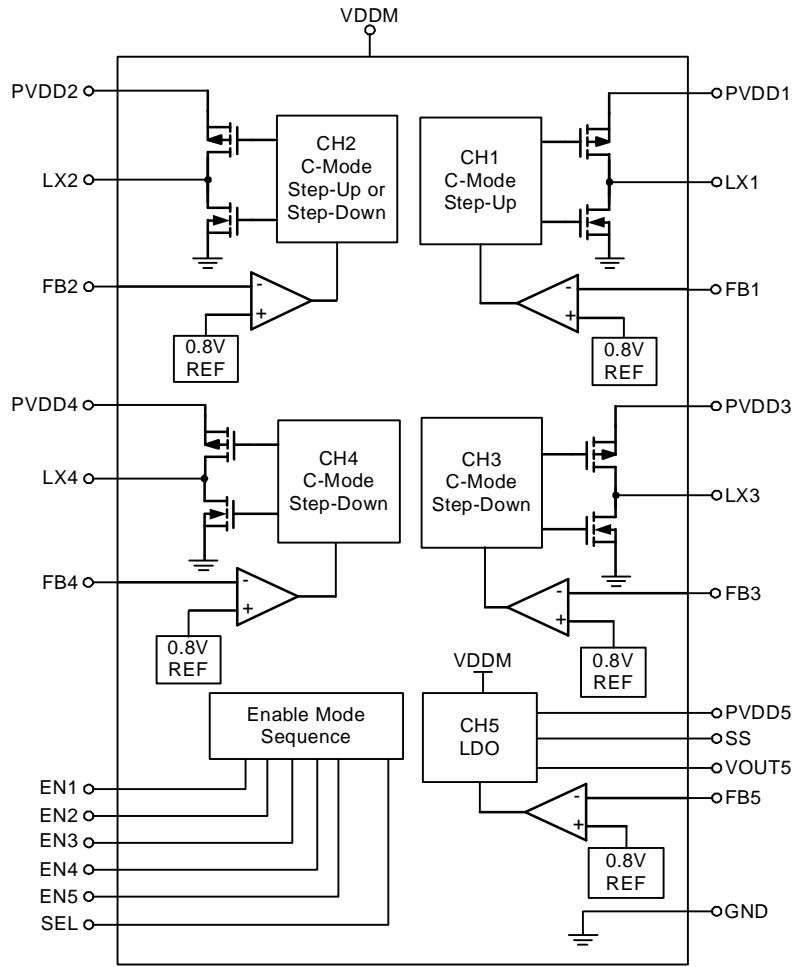

**Absolute Maximum Ratings** (Note 1)

Supply Voltage, VDDM, PVDD5 -----	0.3V to 7V
Power Switch :	
LX1, LX2, LX3, LX4-----	-0.3V to 6.5V
The Other Pins -----	-0.3V to 6.5V
Power Dissipation, P <sub>D</sub> @ T <sub>A</sub> = 25°C	
WQFN 24L 4x4 -----	1.852W
Package Thermal Resistance (Note 2)	
WQFN 24L 4x4, θ <sub>JA</sub> -----	54°C/W
WQFN 24L 4x4, θ <sub>JC</sub> -----	7°C/W
Junction Temperature -----	150°C
Lead Temperature (Soldering, 10 sec.)-----	260°C
Storage Temperature Range -----	-65°C to 150°C
ESD Susceptibility (Note 3)	
HBM (Human Body Mode) -----	2kV
MM (Machine Mode) -----	200V

**Recommended Operating Conditions** (Note 4)

Junction Temperature Range -----	-40°C to 125°C
Ambient Temperature Range -----	-40°C to 85°C

**Electrical Characteristics**

(V<sub>DDM</sub> = 3.3V, T<sub>A</sub> = 25°C, unless otherwise specified)

Parameter	Symbol	Test Conditions	Min	Typ	Max	Unit
<b>Supply Voltage</b>						
VDDM Operating Voltage	V <sub>DDM</sub>		2.7	--	5.5	V
VDDM Startup Voltage	V <sub>ST</sub>		1.5	--	--	V
VDDM Over Voltage Protection			5.7	6	6.25	V
PVDD5 Operating Voltage	V <sub>PVDD5</sub>		2.5	--	5.5	V
<b>Supply Current</b>						
Shutdown Supply Current into VDDM	I <sub>OFF</sub>	All EN = 0	--	--	0.1	μA
CH1 (Syn Step-Up) : Supply Current into VDDM	I <sub>Q1</sub>	Non Switching, EN1 = 3.3V	--	--	800	μA
CH2 (Syn Step-Up or Syn Step-Down) : Supply Current into VDDM	I <sub>Q2</sub>	Non Switching, EN2 = 3.3V	--	--	800	μA
CH3 (Syn Step-Down) : Supply Current into VDDM	I <sub>Q3</sub>	Non Switching, EN3 = 3.3V	--	--	800	μA
CH4 (Syn Step-Down) : Supply Current into VDDM	I <sub>Q4</sub>	Non Switching, EN4 = 3.3V	--	--	800	μA
CH5 (LDO) : Supply Current into PVDD5	I <sub>Q5</sub>	EN5 = 3.3V, I <sub>OUT</sub> = 0mA	--	90	130	μA

*To be continued*

Parameter	Symbol	Test Conditions	Min	Typ	Max	Unit
<b>Oscillator</b>						
CH1,2,3,4 Operating Frequency	f <sub>osc</sub>		900	1000	1100	kHz
CH1 Maximum Duty Cycle (Step-Up)		V <sub>FB1</sub> = 0.7V	80	83	86	%
CH2 Maximum Duty Cycle (Step-Up)		V <sub>FB2</sub> = 0.7V	80	83	86	%
CH2 Maximum Duty Cycle (Step-Down)		V <sub>FB2</sub> = 0.7V	--	--	100	%
CH3 Maximum Duty Cycle (Step-Down)		V <sub>FB3</sub> = 0.7V	--	--	100	%
CH4 Maximum Duty Cycle (Step-Down)		V <sub>FB4</sub> = 0.7V	--	--	100	%
<b>Feedback Regulation Voltage</b>						
Feedback Regulation Voltage @ FB1, FB2, FB3, FB4, FB5			0.788	0.8	0.812	V
Total Accuracy (Including load regulation and line regulation)			-3	--	3	%
<b>Power Switch</b>						
CH1 On Resistance of MOSFET	R <sub>DS(ON)</sub>	P-MOSFET, PVDD1 = 3.3V	--	200	250	mΩ
		N-MOSFET, PVDD1 = 3.3V	--	150	200	
CH1 Current Limitation (Step-Up)			--	3	--	A
CH2 On Resistance of MOSFET	R <sub>DS(ON)</sub>	P-MOSFET, PVDD2 = 3.3V	--	200	250	mΩ
		N-MOSFET, PVDD2 = 3.3V	--	150	200	
CH2 Current Limitation (Step-Down)			--	1.8	--	A
CH2 Current Limitation (Step-Up)			--	3	--	A
CH3 On Resistance of MOSFET	R <sub>DS(ON)</sub>	P-MOSFET, PVDD3 = 3.3V	--	350	400	mΩ
		N-MOSFET, PVDD3 = 3.3V	--	300	400	
CH3 Current Limitation (Step-Down)			--	1.5	--	A
CH4 On Resistance of MOSFET	R <sub>DS(ON)</sub>	P-MOSFET, PVDD4 = 3.3V	--	350	400	mΩ
		N-MOSFET, PVDD4 = 3.3V	--	300	400	
CH4 Current Limitation (Step-Down)			--	1.5	--	A
CH5 Dropout Voltage (LDO)	V <sub>Drop</sub>	2.2V ≤ PVDD5 ≤ 2.7V, I <sub>OUT</sub> = 400mA	--	160	320	mV
		2.7V ≤ PVDD5 ≤ 5.5V, I <sub>OUT</sub> = 500mA	--	250	400	
<b>Protection</b>						
Over Voltage Protection of CH1, CH2 Step-Up, PVDD1 and PVDD2			5.7	6	6.25	V
Over Voltage Protection Hysteresis of CH1, CH2 Step-Up, PVDD1 and PVDD2			--	0.5	--	V
Under Voltage Protection (CH1 to CH5)		FB Threshold	0.36	0.4	0.44	V
CH5 Current Limit	I <sub>LIM</sub>	2.2V ≤ PVDD5 ≤ 2.7V	0.4	0.7	1.05	A
		2.7V ≤ PVDD5 ≤ 5.5V	0.5	0.8	1.05	
Protection Fault Delay			--	100	--	ms

To be continued



Parameter		Symbol	Test Conditions	Min	Typ	Max	Unit
<b>Control</b>							
EN1 to EN5, SEL Input Threshold	Logic High			1.3	--	5.5	V
	Logic Low			--	--	0.4	V
EN1 to EN5, SEL Sink Current				--	2	6	μA
<b>CH5 LDO Regulation</b>							
Line Regulation		$\Delta V_{LINE}$	$V_{PVDD5} = (V_{OUT5} + 1V)$ to 5.5V $I_{OUT} = 1mA$	--	--	0.3	%
Load Regulation		$\Delta V_{LOAD}$	$1mA < I_{OUT} < 300mA$	--	--	0.6	%
Power Supply Rejection Rate	f = 100Hz	PSRR	$C_{OUT} = 1\mu F, I_{OUT} = 100mA$	--	-60	--	dB
	f = 10kHz			--	-30	--	
<b>Thermal Protection</b>							
Thermal Shutdown		$T_{SD}$		125	160	--	°C
Thermal Shutdown Hysteresis		$\Delta T_{SD}$		--	20	--	°C

**Note 1.** Stresses listed as the above “Absolute Maximum Ratings” may cause permanent damage to the device. These are for stress ratings. Functional operation of the device at these or any other conditions beyond those indicated in the operational sections of the specifications is not implied. Exposure to absolute maximum rating conditions for extended periods may remain possibility to affect device reliability.

**Note 2.**  $\theta_{JA}$  is measured in the natural convection at  $T_A = 25^\circ C$  on a high effective four layers thermal conductivity test board of JEDEC 51-7 thermal measurement standard. The case point of  $\theta_{JC}$  is on the expose pad for the WQFN package.

**Note 3.** Devices are ESD sensitive. Handling precaution is recommended.

**Note 4.** The device is not guaranteed to function outside its operating conditions.

Typical Operating Characteristics

CH1 Step-Up Efficiency vs. Output Current

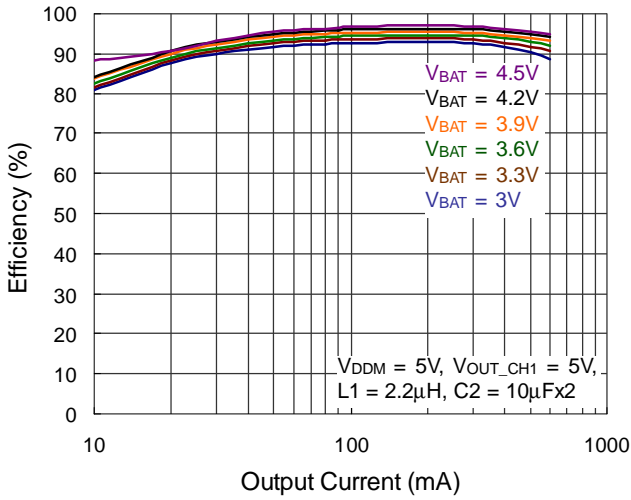

CH1 Step-Up Efficiency vs. Output Current

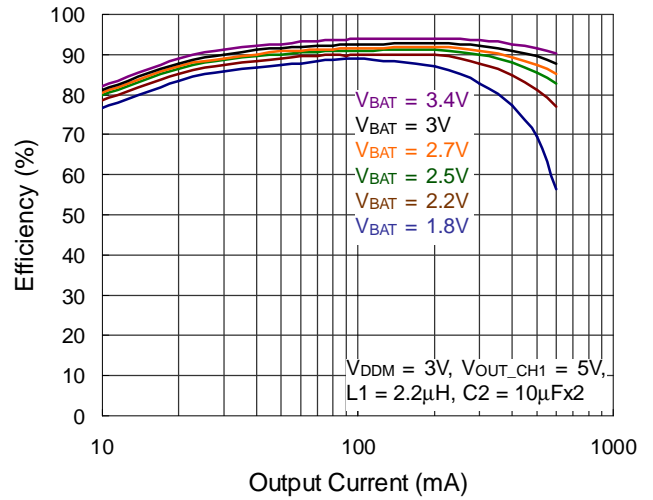

CH2 Step-Down Efficiency vs. Output Current

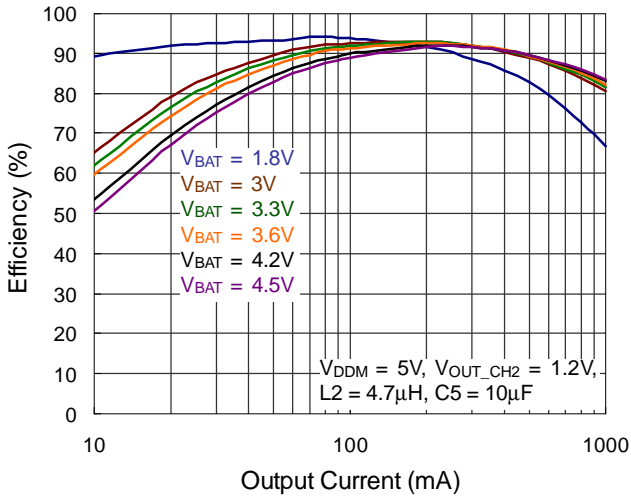

CH2 Step-Up Efficiency vs. Output Current

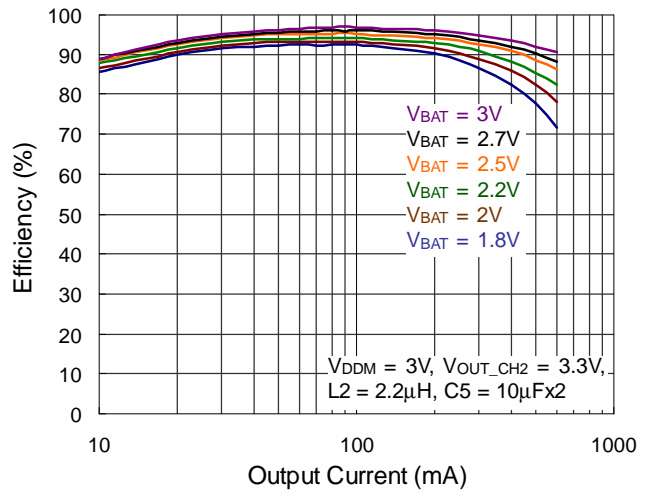

CH3 Step-Down Efficiency vs. Output Current

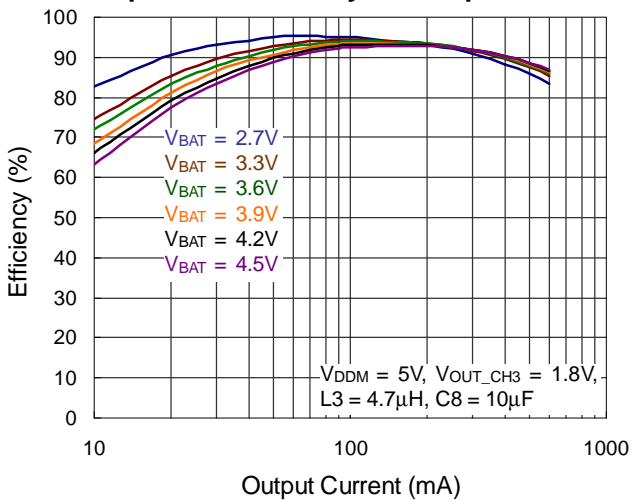

CH3 Step-Up Efficiency vs. Output Current

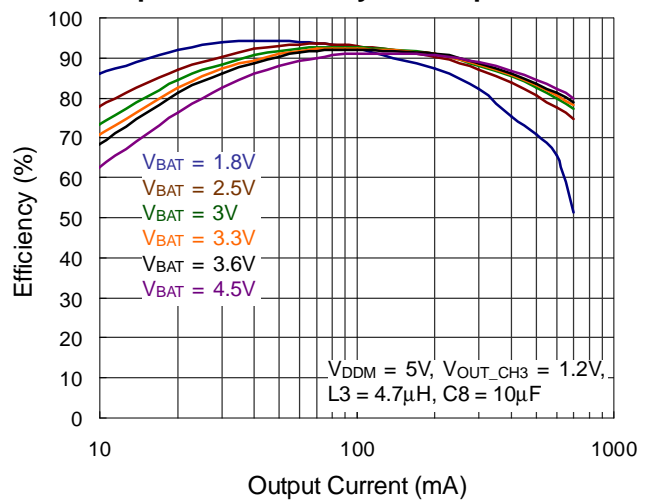

CH4 Step-Down Efficiency vs. Output Current

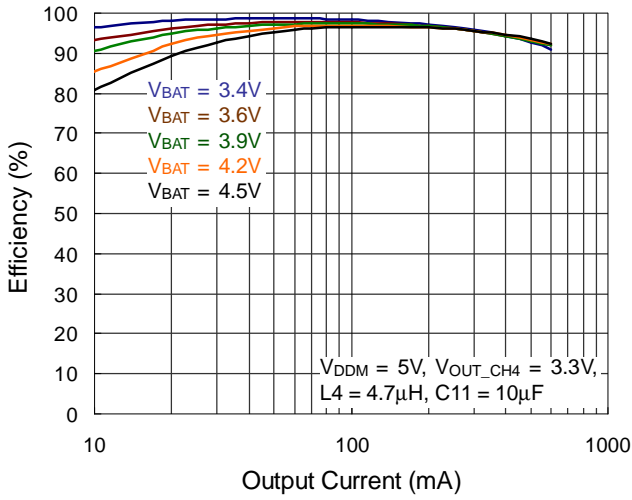

CH4 Step-Down Efficiency vs. Output Current

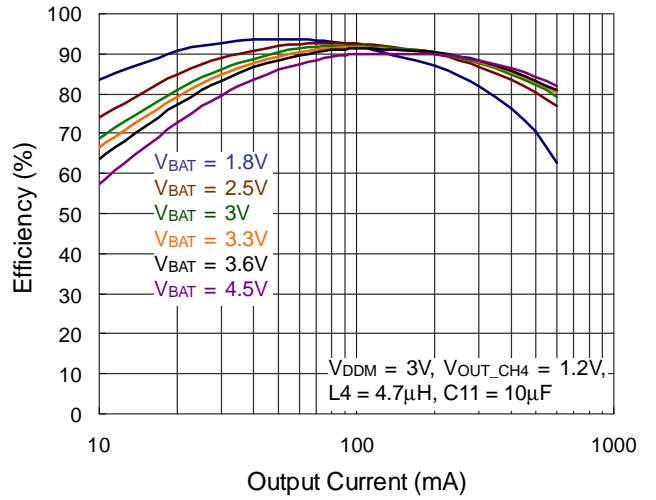

CH1 Step-Up Output Voltage vs. Output Current

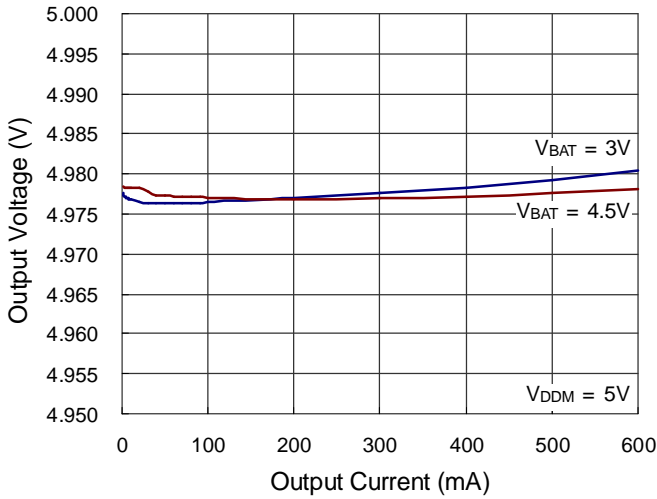

CH2 Step-Down Output Voltage vs. Output Current

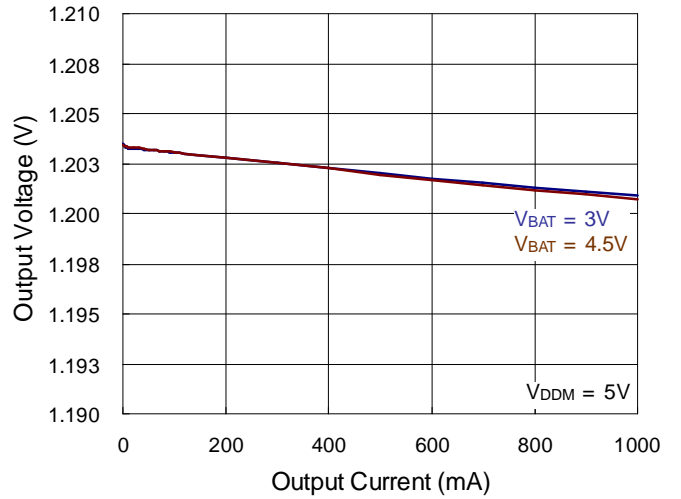

CH2 Step-Up Output Voltage vs. Output Current

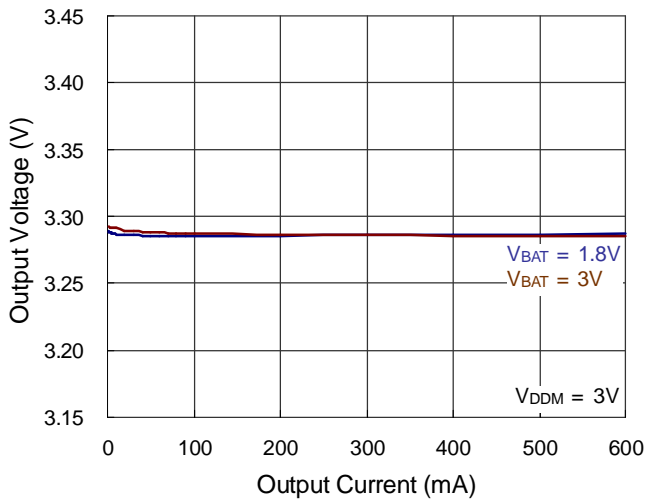

CH3 Step-Down Output Voltage vs. Output Current

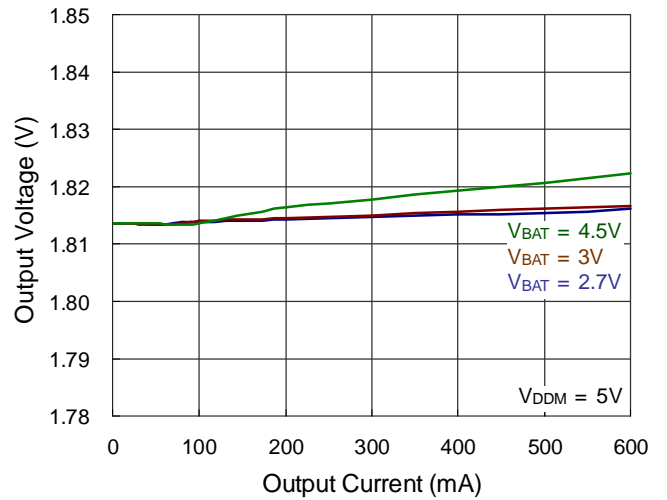

CH4 Step-Down Output Voltage vs. Output Current

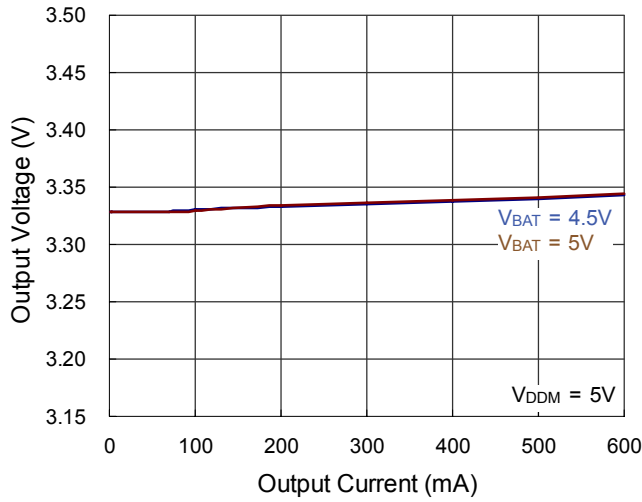

CH1 Output Voltage Ripple

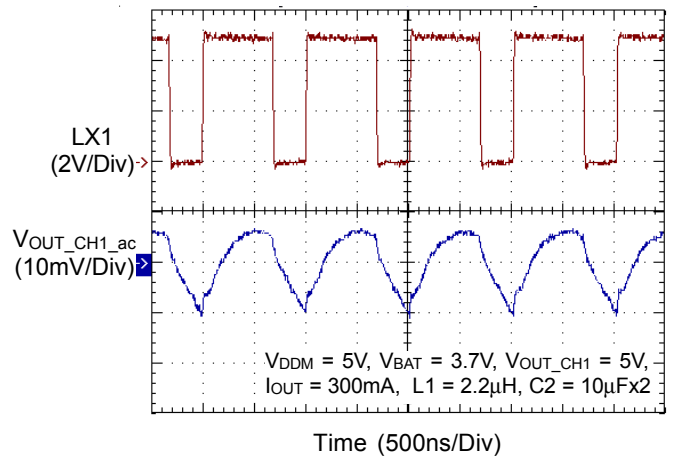

CH2 Step-Down Output Voltage Ripple

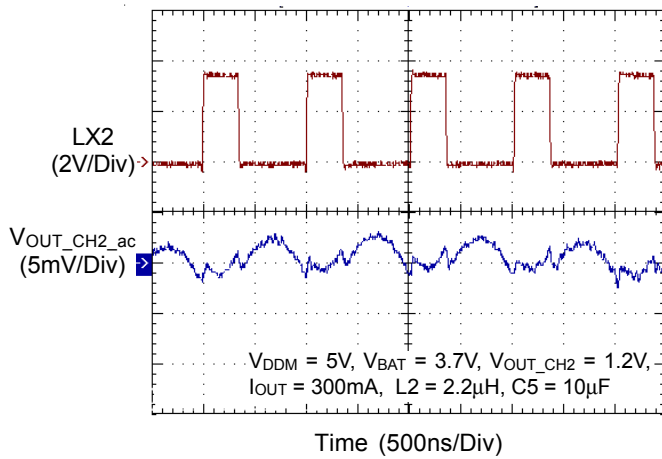

CH2 Step-Up Output Voltage Ripple

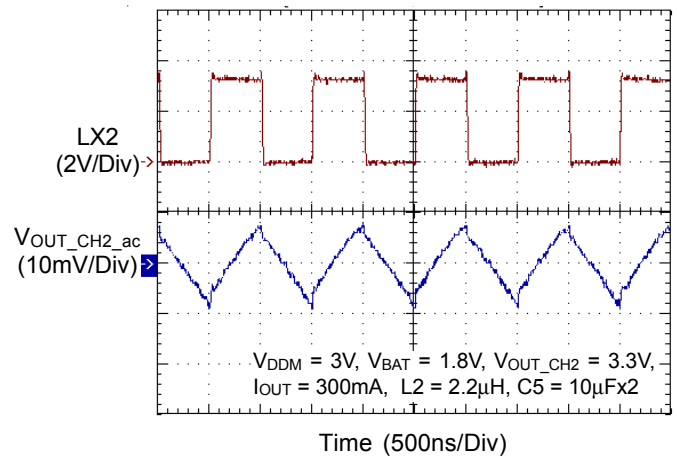

CH3 Output Voltage Ripple

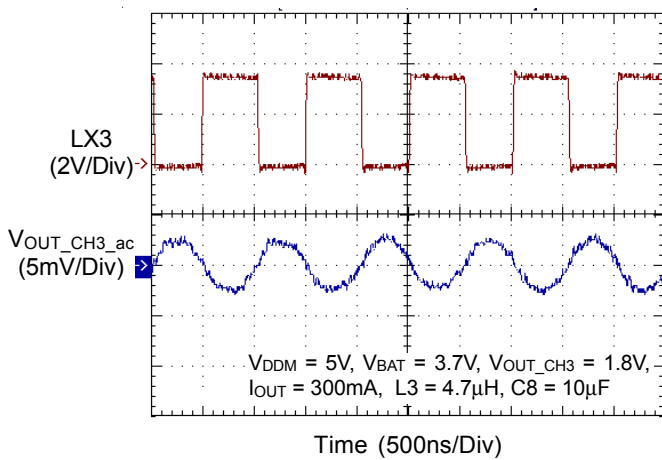

CH4 Output Voltage Ripple

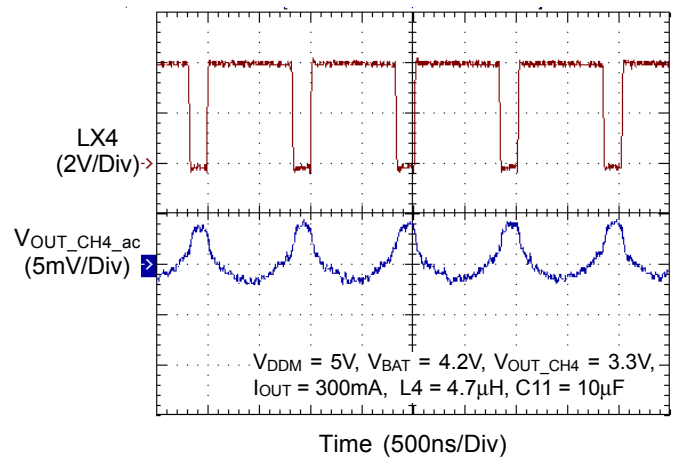

CH1 Load Transient Response

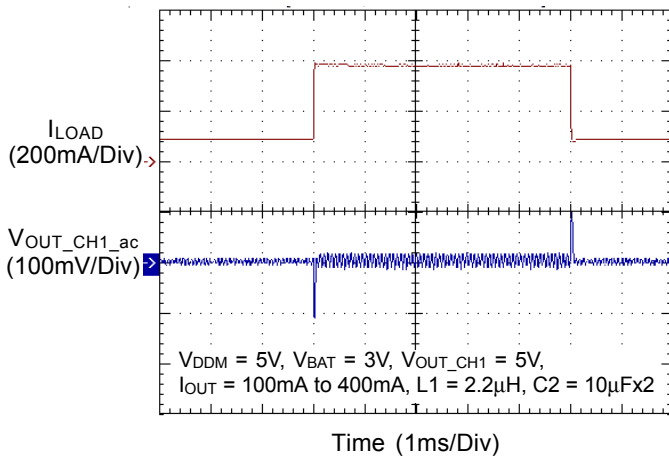

CH2 Step-Down Load Transient Response

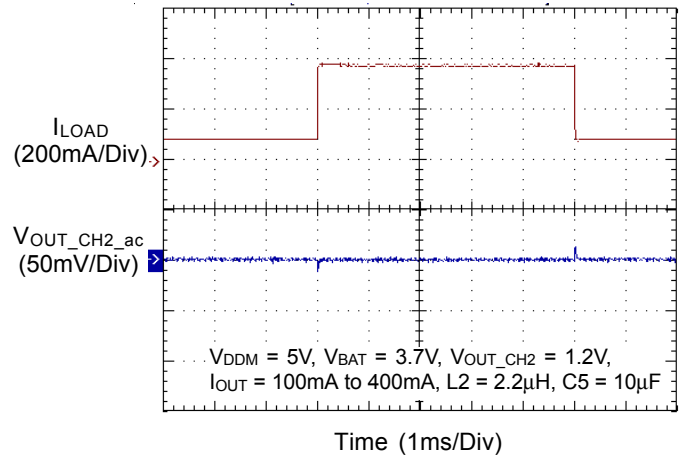

CH2 Step-Up Load Transient Response

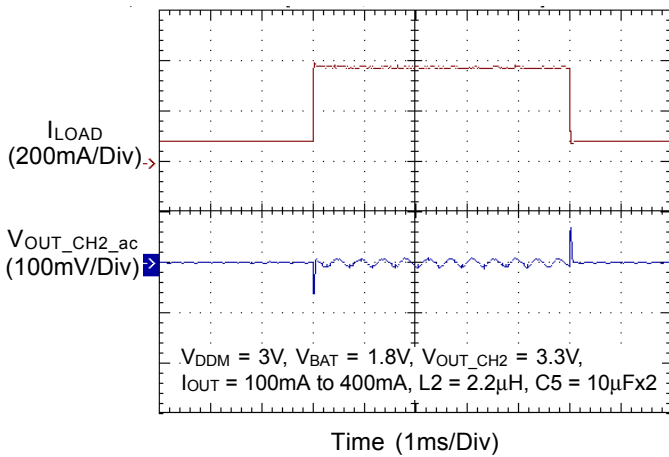

CH3 Load Transient Response

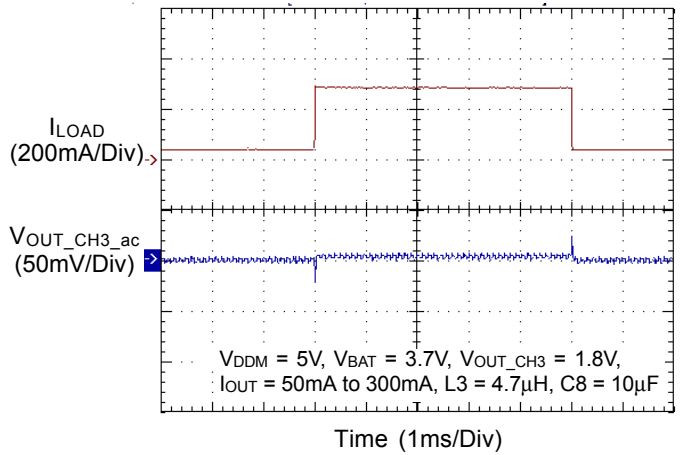

CH4 Load Transient Response

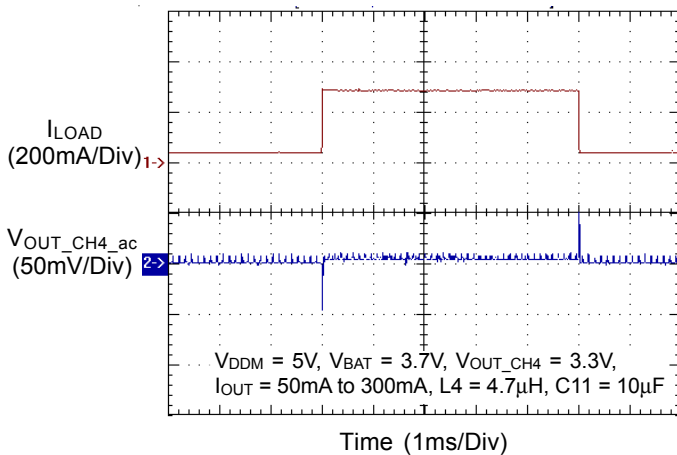

Frequency vs. Temperature

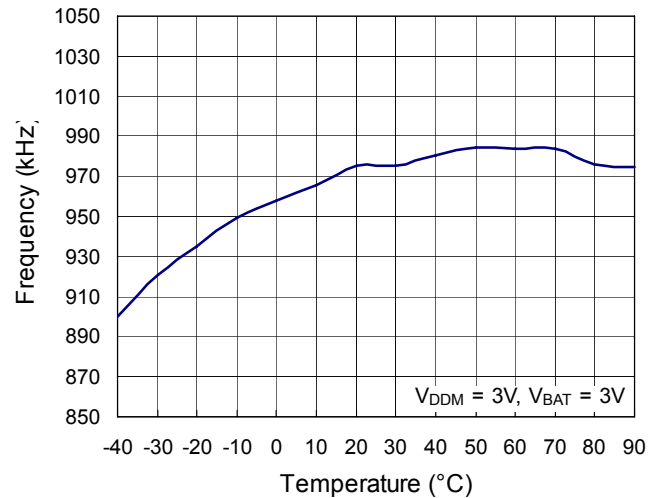

CH5 LDO Output Voltage vs. Output Current

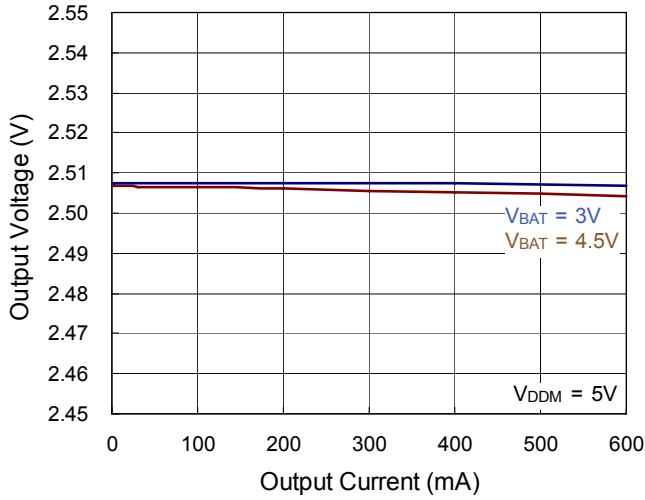

CH5 LDO Dropout Voltage vs. Output Current

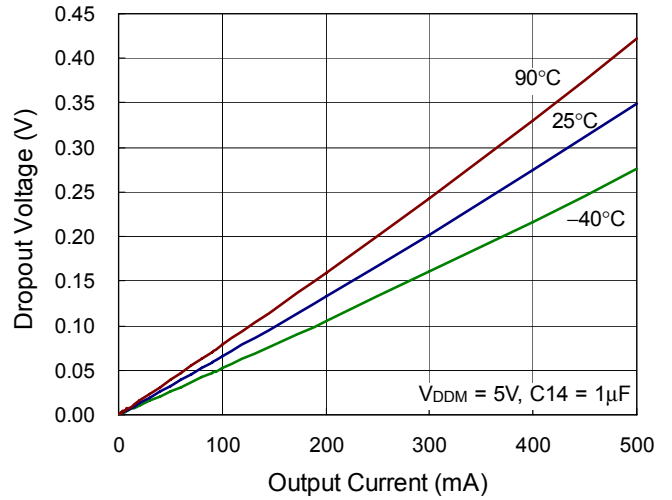

CH5 LDO Load Transient Response

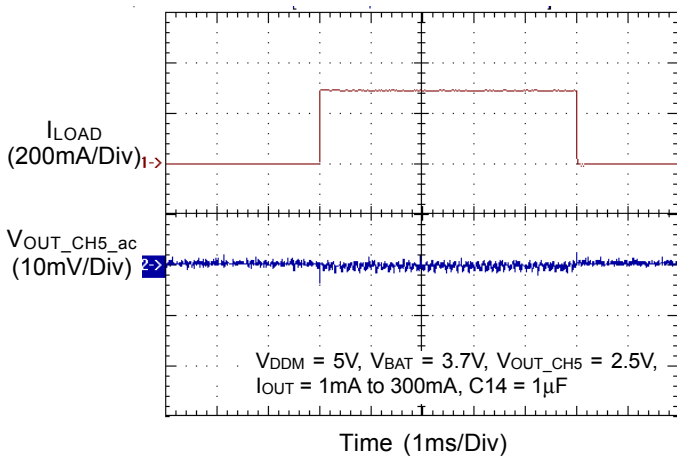

CH5 LDO Output Voltage vs. Temperature

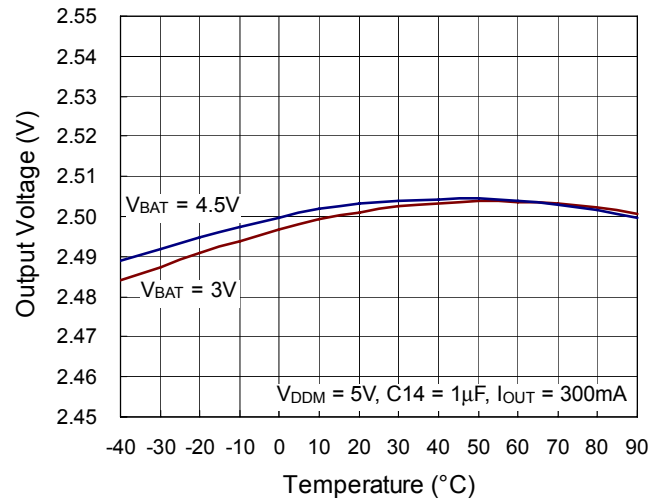

CH5 LDO PSRR

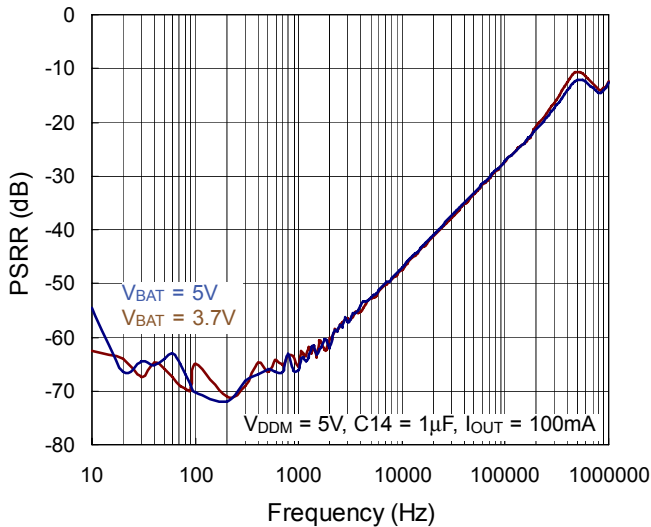

CH5 LDO IPVDD5 Quiescent Current vs. Temperature

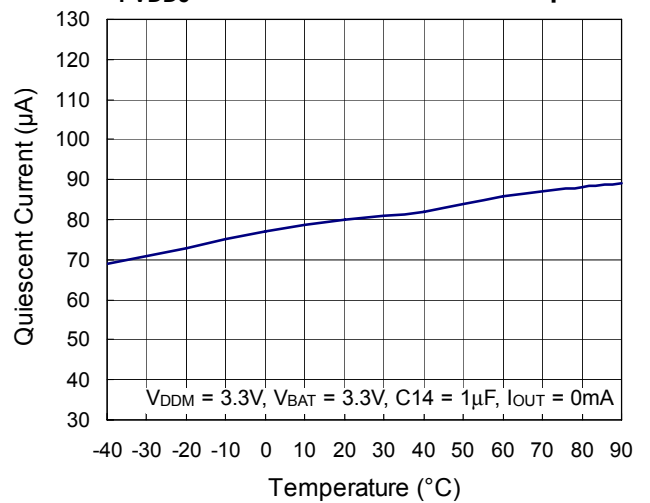

## Application information

The RT9953 includes the following four DC/DC converters and one LDO to build a multiple-output power-supply system.

### CH1 : Synchronous Step-Up DC/DC Converter

The CH1 is a synchronous step-up converter for motor or DSC system I/O power. The converter operates at fixed frequency and PWM Current Mode. The CH1 converter integrated internal MOSFETs, compensation network and synchronous rectifier for up to 95% efficiency.

The output voltage can be set by the following equation :

$$V_{OUT\_CH1} = (1+R1/R2) \times V_{FB1}$$

Where  $V_{FB1}$  is 0.8V typically.

### CH2 : Synchronous Step-Up or Step-Down Selectable DC/DC Converter

The CH2 is a synchronous step-up/step-down selectable converter for motor or DSC system I/O power.

#### Mode setting

The CH2 of RT9953 features flexible Step-up or Step-down topology setting for either 1 x Li-ion or 2 x AA application by SEL pin. Please refer to "Electrical Characteristics" for level of Logic-High or Logic-Low. When the CH2 operates as a Step-up converter, the SEL must be set at Logic-High. If the CH2 operates at Step-down mode, the SEL must be set at Logic-Low. In addition, please note that the logic state can not be changed during operation.

**Table 2. CH2 Mode Setting**

SEL	CH2 Operating Mode
Logic-High	Step-Up
Logic-Low	Step-Down

#### Step-Up :

The converter operates at fixed frequency PWM Mode, continuous current mode (CCM), and discontinuous current mode (DCM) with internal MOSFETs, compensation network and synchronous rectifier for up to 95% efficiency.

#### Step-Down :

The converter operates at fixed frequency PWM mode and continuous current mode (CCM) with internal MOSFETs, compensation network and synchronous rectifier for up to 95% efficiency. The CH2 Step-down converter can be operating at 100% maximum duty cycle to extend the input operating voltage range. While the input voltage is close to the output voltage, the converter enters low dropout mode.

The output voltage can be set by the following equation :

$$V_{OUT\_CH2} = (1+R3/R4) \times V_{FB2}$$

Where  $V_{FB2}$  is 0.8V typically.

### CH3 and CH4 : Synchronous Step-Down DC/DC Converter

The converter operates at fixed frequency PWM mode, CCM and integrated internal MOSFETs and compensation network. The CH3 and CH4 Step-down converter can be operating at 100% maximum duty cycle to extend battery operating voltage range. When the input voltage is close to the output voltage, the converter could enter low dropout mode with low output ripple.

The output voltage can be set by the following equation :

$$V_{OUT\_CH3} = (1+R5/R6) \times V_{FB3}$$

$$V_{OUT\_CH4} = (1+R7/R8) \times V_{FB4}$$

Where  $V_{FB3}$  and  $V_{FB4}$  is 0.8V typically.

### CH5 : 500mA Low Dropout, Low Noise Linear Regulator

Like any low-dropout regulator, this CH requires input and output decoupling capacitors. The CH5 linear regulator can support 500mA output current when  $PVDD5 > 2.7V$ . The typical current limit is 0.8A. If the output is shorted to ground, the Under Voltage Protection function will be triggered to shutdown the IC to prevent the part from damaging.

The output voltage can be set by the following equation :

$$V_{OUT\_CH5} = (1+R9/R10) \times V_{FB5}$$

Where  $V_{FB5}$  is 0.8V typically.

## Thermal Considerations

For continuous operation, do not exceed absolute maximum operation junction temperature. The maximum power dissipation depends on the thermal resistance of IC package, PCB layout, the rate of surroundings airflow and temperature difference between junction to ambient. The maximum power dissipation can be calculated by following formula :

$$P_{D(MAX)} = (T_{J(MAX)} - T_A) / \theta_{JA}$$

Where  $T_{J(MAX)}$  is the maximum operation junction temperature,  $T_A$  is the ambient temperature and the  $\theta_{JA}$  is the junction to ambient thermal resistance.

For recommended operating conditions specification of RT9953, the maximum junction temperature is 125°C. The junction to ambient thermal resistance  $\theta_{JA}$  is layout dependent. For WQFN-24L 4x4 package, the thermal resistance  $\theta_{JA}$  is 54°C/W on the standard JEDEC 51-7 four layers thermal test board. The maximum power dissipation at  $T_A = 25^\circ\text{C}$  can be calculated by following formula :

$$P_{D(MAX)} = (125^\circ\text{C} - 25^\circ\text{C}) / (54^\circ\text{C/W}) = 1.852\text{W for WQFN-24L 4x4}$$

The maximum power dissipation depends on operating ambient temperature for fixed  $T_{J(MAX)}$  and thermal resistance  $\theta_{JA}$ . For RT9953 package, the Figure 1 of derating curve allows the designer to see the effect of rising ambient temperature on the maximum power dissipation allowed.

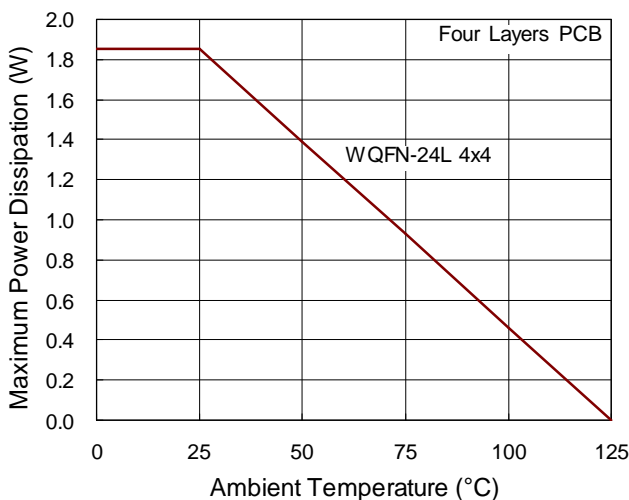

Figure 1. Derating Curves for RT9953 Package

## Layout Considerations

For the best performance of the RT9953, the following PCB layout guidelines must be strictly followed :

- } Place the input and output capacitors as close as possible to the input and output pins respectively for good filtering.
- } Keep the main power traces as wide and short as possible.
- } The switching node area connected to LX and inductor should be minimized for lower EMI.
- } Place the feedback components as close as possible to the FB pin and keep these components away from the noisy devices.
- } Connect the GND and Exposed Pad to a strong ground plane for maximum thermal dissipation and noise protection.
- } CH5 PCB trace and component had put different PCB side to avoid LX3 and LX4 switching noise.



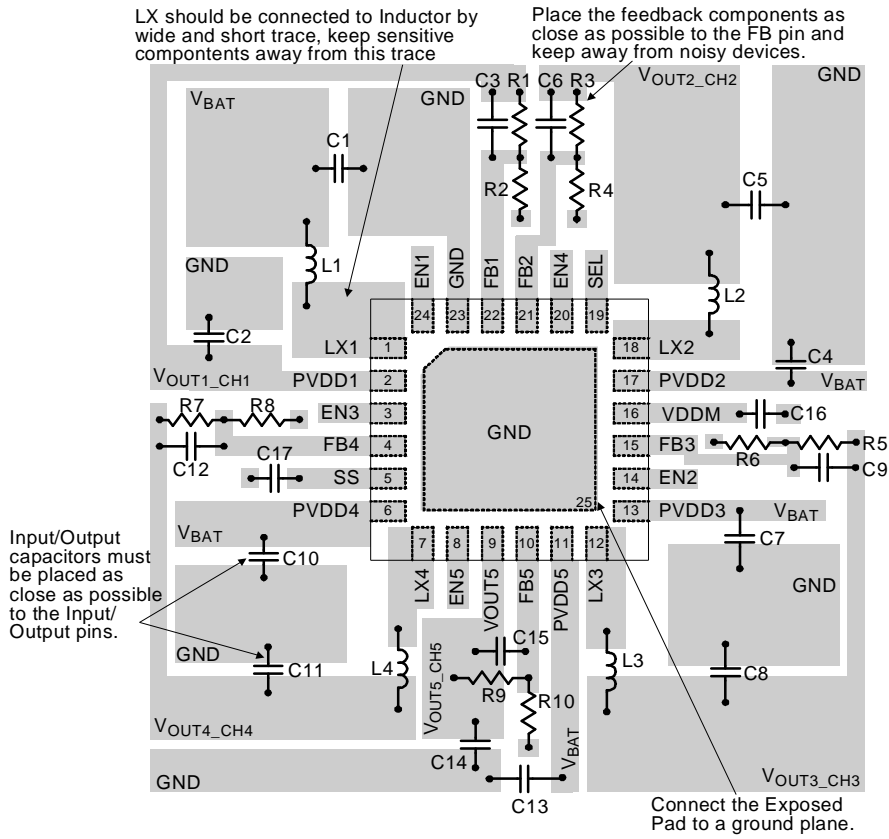
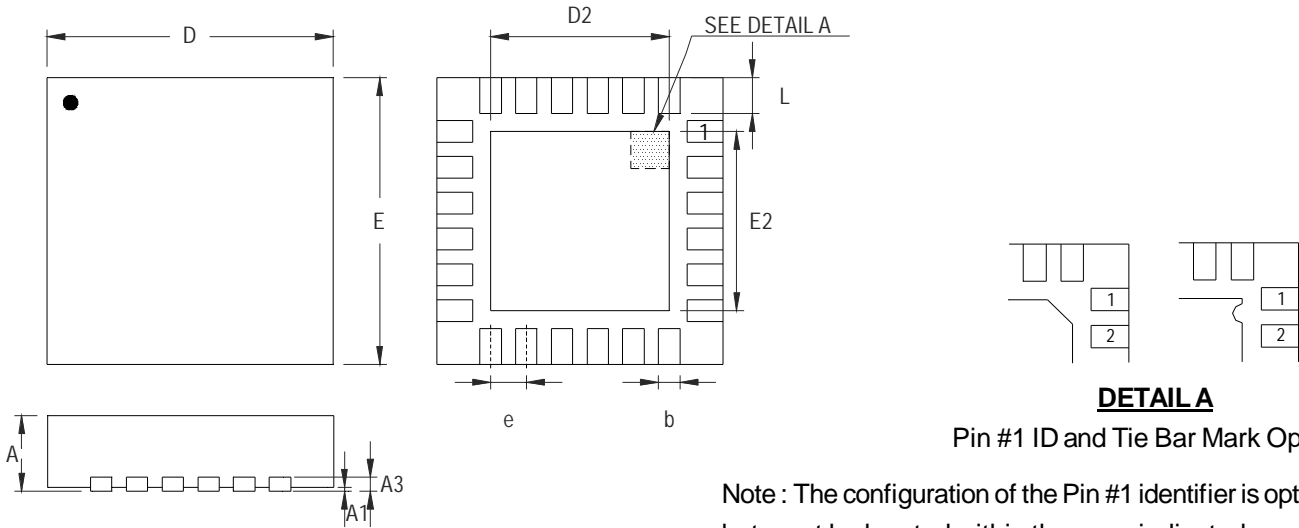

Figure 2. PCB Layout Guide

Table 3. Protection Items

	Protection type	Threshold (typical) Refer to Electrical spec	Protection methods	Delay time	Reset method
V <sub>DDM</sub>	Over Voltage Protection	V <sub>DDM</sub> > 6V	Disable all channels	100ms	Restart if V <sub>DDM</sub> < 5.5V (with hysteresis)
CH1 Step-Up	Current Limit	N-MOSFET current > 3A	IC shutdown	100ms	V <sub>DDM</sub> power reset
	PVDD1 OVP	PVDD1 > 6V	IC shutdown	No-delay	V <sub>DDM</sub> power reset
CH2 Step-Up	Current Limit	N-MOSFET current > 3A	IC shutdown	100ms	V <sub>DDM</sub> power reset
	PVDD2 OVP	PVDD2 > 6V	IC shutdown	No-delay	V <sub>DDM</sub> power reset
CH2 Step-Down	OCP	P-MOSFET current > 1.5A	IC shutdown	100ms	V <sub>DDM</sub> power reset
	UVP	FB2 < 0.4V	IC shutdown	100ms	V <sub>DDM</sub> power reset
CH3 Step-Down	OCP	P-MOSFET current > 1.5A	IC shutdown	100ms	V <sub>DDM</sub> power reset
	UVP	FB3 < 0.4V	IC shutdown	100ms	V <sub>DDM</sub> power reset
CH4 Step-Down	OCP	P-MOSFET current > 1.5A	IC shutdown	100ms	V <sub>DDM</sub> power reset
	UVP	FB4 < 0.4V	IC shutdown	100ms	V <sub>DDM</sub> power reset
CH5 LDO	Current Limit	I <sub>OUT</sub> (P-MOSFET current) > 0.8A	Current Limiting	No-delay	No reset
	UVP	FB5 < 0.4V	IC shutdown	100ms	V <sub>DDM</sub> power reset
Thermal	Thermal shutdown	Temperature > 160°C	All channels stop switching	100ms	Temperature < 140°C

**Outline Dimension**



**DETAIL A**

Pin #1 ID and Tie Bar Mark Options

Note : The configuration of the Pin #1 identifier is optional, but must be located within the zone indicated.

Symbol	Dimensions In Millimeters		Dimensions In Inches	
	Min	Max	Min	Max
A	0.700	0.800	0.028	0.031
A1	0.000	0.050	0.000	0.002
A3	0.175	0.250	0.007	0.010
b	0.180	0.300	0.007	0.012
D	3.950	4.050	0.156	0.159
D2	2.300	2.750	0.091	0.108
E	3.950	4.050	0.156	0.159
E2	2.300	2.750	0.091	0.108
e	0.500		0.020	
L	0.350	0.450	0.014	0.018

**W-Type 24L QFN 4x4 Package**

**Richtek Technology Corporation**

Headquarter  
5F, No. 20, Taiyuen Street, Chupei City  
Hsinchu, Taiwan, R.O.C.  
Tel: (8863)5526789 Fax: (8863)5526611

**Richtek Technology Corporation**

Taipei Office (Marketing)  
5F, No. 95, Minchiuan Road, Hsintien City  
Taipei County, Taiwan, R.O.C.  
Tel: (8862)86672399 Fax: (8862)86672377  
Email: marketing@richtek.com

Information that is provided by Richtek Technology Corporation is believed to be accurate and reliable. Richtek reserves the right to make any change in circuit design, specification or other related things if necessary without notice at any time. No third party intellectual property infringement of the applications should be guaranteed by users when integrating Richtek products into any application. No legal responsibility for any said applications is assumed by Richtek.

单击下面可查看定价，库存，交付和生命周期等信息

[>>Richtek\(台湾立锜\)](#)