

Switching Regulator Series

1ch Buck Converter with Integrated FET BD9F800MUX EVK

BD9F800MUX-EVK-001 (12V to 1V, 8A)

Introduction

This user's guide describes the steps required to operate the EVK of BD9F800MUX. The document includes a description of the peripheral components, operating instructions, and reference data.

Description

BD9F800MUX-EVK-001 uses BD9F800MUX to output 1V from a 12V input voltage. The input voltage of the BD9F800MUX is from 4.5V to 28V and the output voltage is configurable from 0.765V to 13.5V with external resistors. The switching frequency can be selected as 300 kHz or 600 kHz. BD9F800MUX is a constant on-time controlled DC/DC converter with fast transient response and does not require external phase compensation circuit. It includes built-in soft start function for start-up rush current protection, Under Voltage Lock Out (UVLO), Thermal Shutdown Detection (TSD), Over Current Protection (OCP), and Short Circuit Protection (SCP).

Application

Step-down power supplies for DSPs, microprocessors, etc.
Set-top box
Liquid crystal TV
DVD/Blu-ray player/recorder
Amusement equipment

EVK Operating Limits

Parameter	Min	Typ	Max	Units	Conditions
Input Voltage	4.5	12.0	28.0	V	
Output Voltage		1.0		V	
Maximum Output Current			8.0	A	
Switching Frequency		300		kHz	
Maximum Efficiency		89		%	$I_o = 2A$
UVLO Threshold Voltage		4.2		V	VIN sweep up
UVLO Hysteresis Voltage		400		mV	

EVK Overview

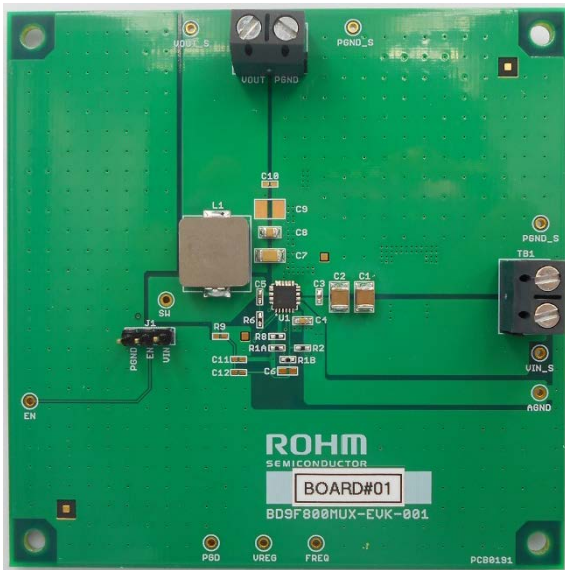

Figure 1. BD9F800MUX-EVK-001(Top View)

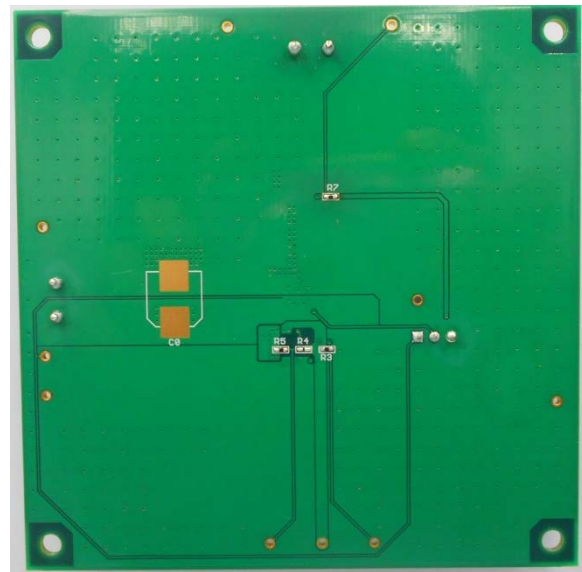

Figure 2. BD9F800MUX-EVK-001(Bottom View)

EVK Schematic

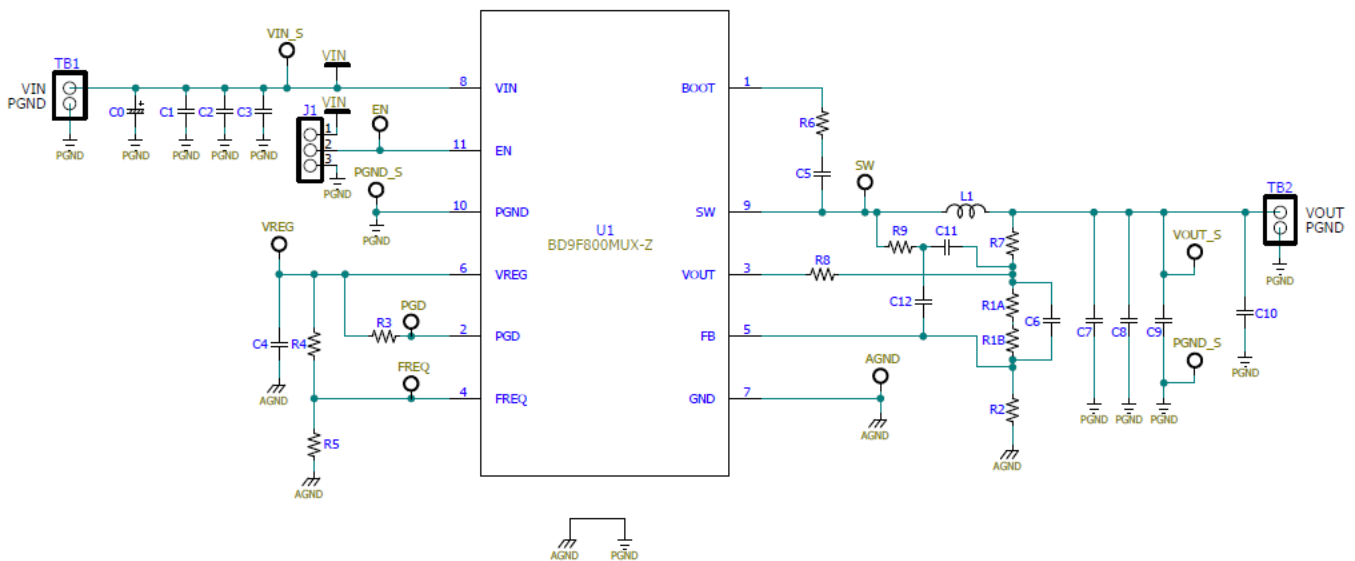

Figure 3. BD9F800MUX-EVK-001 Schematic

Operating Procedure

1. Turn off the DC power supply and connect the GND terminal of the power supply to the PGND pin of TB1.
2. Connect the VCC terminal of the DC power supply to the VIN pin of EVK TB1.
3. Connect the load to the VOUT and GND pins of the EVK TB2. In the case of an electronic load, connect it with the load turned off.
4. Connect the VOUT terminal of the voltmeter to EVK's VOUT_S and the GND terminal to EVK's PGND_S.
5. Connect the J1 jumper to the VIN side.
6. Turn on the DC power. Make sure the voltmeter shows 1 V.
7. Turn on the electronic load.

(Caution) This EVK does not support hot plug. Do not perform hot plug test.

Operating State Settings

Select the status of BD9F800MUX as shown in Table 1 according to the EN pin voltage.

Table 1. EN Pin Setting

EN Pin Voltage	State
HIGH (≥ 2.3 V)	Enable
LOW (≤ 0.7 V)	Shutdown

Switching Frequency Setting

The switching frequency of BD9F800MUX is selected as shown in Table 2 by the FREQ pin. This EVK is equipped with optimum parts at 300 kHz. When changing the operating frequency, it is necessary to change the parts.

Table 2. Switching Frequency Setting

FREQ Pin Voltage	Switching Frequency
HIGH (≥ 2.2 V)	600kHz
LOW (≤ 0.8 V)	300kHz

Parts List

Table 1. Parts List

Count	Parts No.	Type	Value	Description	Manufacturer Part Number	Manufacturer	Configuration (mm)
1	U1	IC	-	Single Synchronous BUCK Converter	BD9F800MUX	ROHM	3.5 x 3.5
1	L1	Inductor	2.2μH	11A max, ±20%	CMLB104T2R2MS	Cyntec	L W
0	C0	-	-	Open	-	-	-
1	C1	Ceramic Capacitor	10μF	50V, X5R, ±20%	GRM32ER61H106MA12	Murata	3225
1	C2	Ceramic Capacitor	10μF	50V, X5R, ±20%	GRM32ER61H106MA12	Murata	3225
1	C3	Ceramic Capacitor	0.1μF	50V, X5R, ±10%	GRM155R61H104KE14	Murata	1005
1	C4	Ceramic Capacitor	2.2μF	10V, X5R, ±10%	GRM188R61A225KE34	Murata	1608
1	C5	Ceramic Capacitor	0.1μF	10V, X5R, ±10%	GRM152R61A104KE19	Murata	1005
0	C6	-	-	Open	-	-	-
1	C7	Ceramic Capacitor	47μF	6.3V, X5R, ±20%	GRM31CR60J476ME19	Murata	3216
1	C8	Ceramic Capacitor	22μF	6.3V, X5R, ±20%	GRM21BR60J226ME39	Murata	2012
0	C9	-	-	Open	-	-	-
0	C10	-	-	Open	-	-	-
0	C11	-	-	Open	-	-	-
0	C12	-	-	Open	-	-	-
1	R1A	Resistor	0Ω	Jumper	MCR01MZPJ000	ROHM	1005
1	R1B	Resistor	6.8kΩ	50V, ±1%, 1/16W	MCR01MZPF6801	ROHM	1005
1	R2	Resistor	22kΩ	50V, ±1%, 1/16W	MCR01MZPF2202	ROHM	1005
1	R3	Resistor	100kΩ	50V, ±1%, 1/16W	MCR01MZPF1003	ROHM	1005
0	R4	-	-	Open	-	-	-
1	R5	Resistor	10kΩ	50V, ±1%, 1/16W	MCR01MZPF1002	ROHM	1005
1	R6	Resistor	0Ω	Jumper	MCR01MZPJ000	ROHM	1005
1	R7	Resistor	0Ω	Jumper	MCR01MZPJ000	ROHM	1005
1	R8	Resistor	0Ω	Jumper	MCR01MZPJ000	ROHM	1005
0	R9	-	-	Open	-	-	-

EVK PCB Layout

EVK PCB Information

Number of Layers	Material	Board Size	Copper Thickness
4	FR-4	85mm x 85mm x 1.6mm	2oz (70µm) *Top, Bottom Layer 1oz (35µm) *Middle Layers

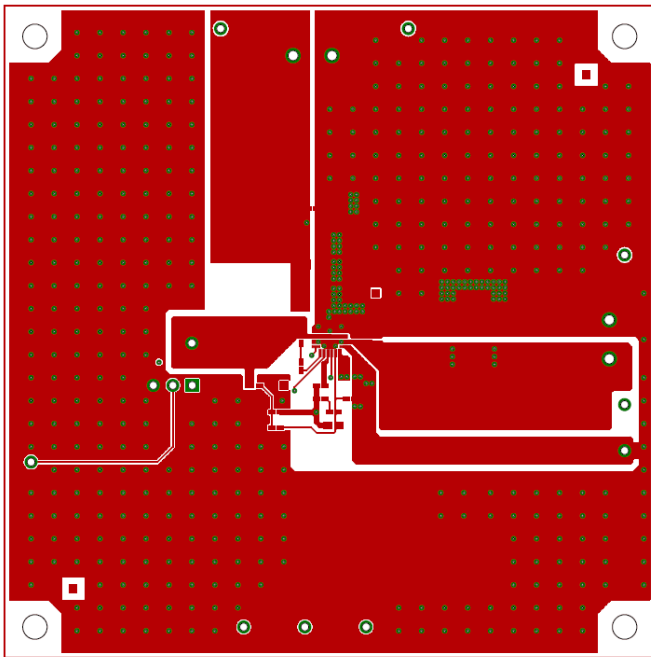

Figure 4. Top Layer Layout (Top View)

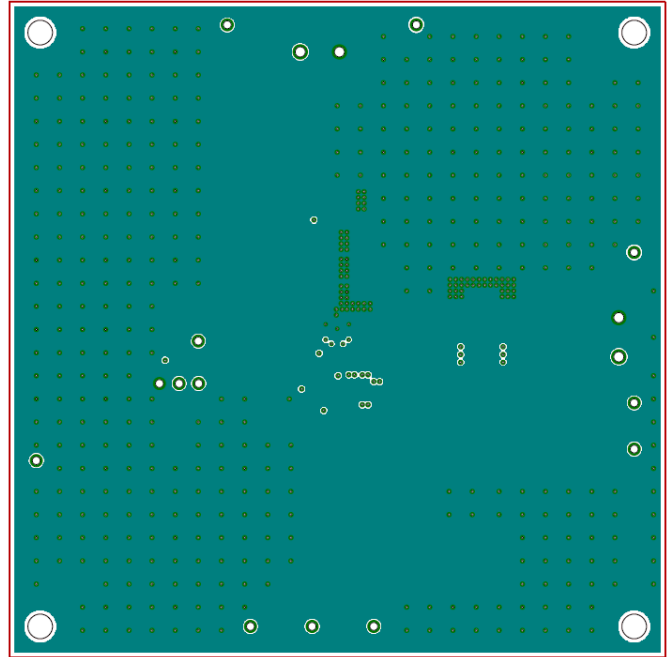

Figure 5. Middle1 Layer Layout (Top View)

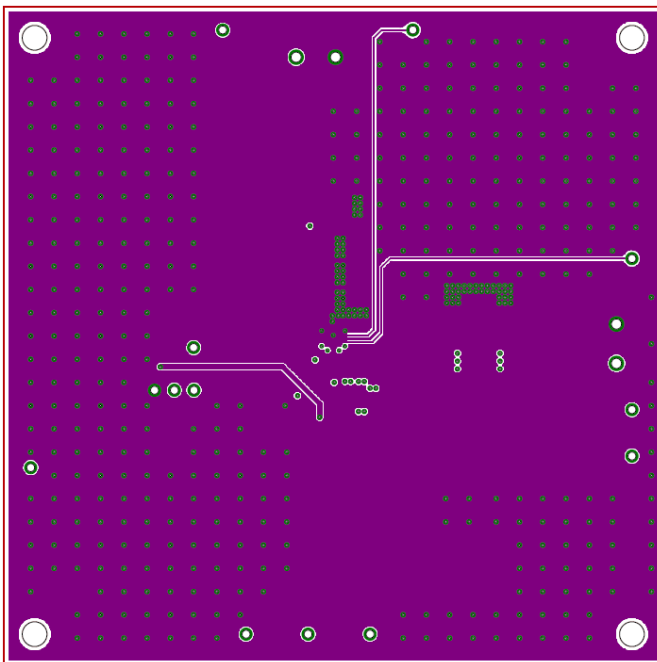

Figure 6. Middle2 Layer Layout (Top View)

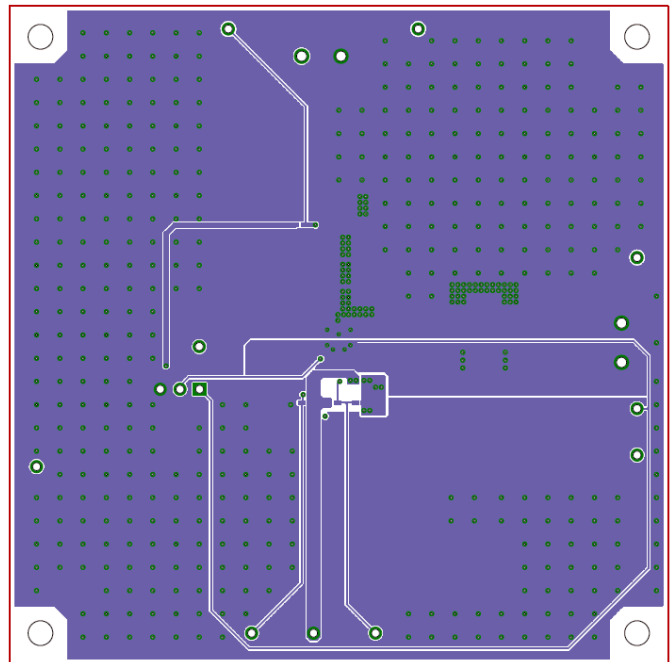

Figure 7. Bottom Layer Layout (Top View)

Reference Application Curves

Ta = 25°C, VCC = 12V, EN = VCC, unless otherwise specified

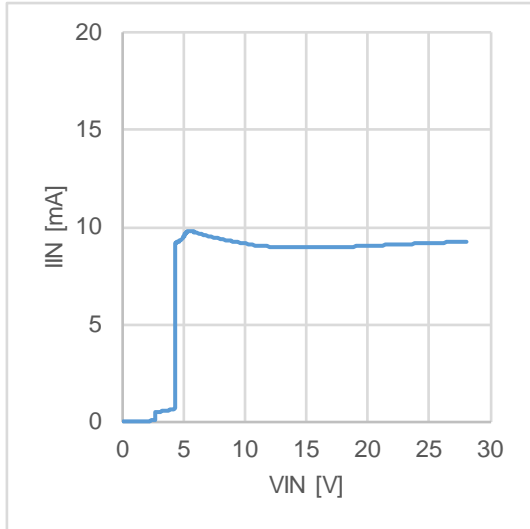

Figure 8. Current Consumption vs VIN
(IO = 0mA)

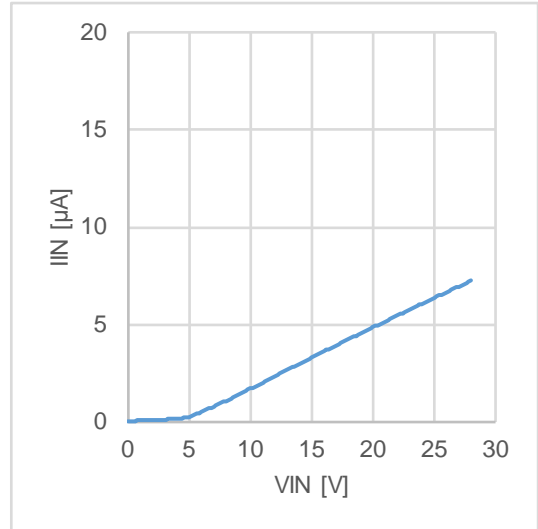

Figure 9. Shutdown Current vs VIN
(EN=GND)

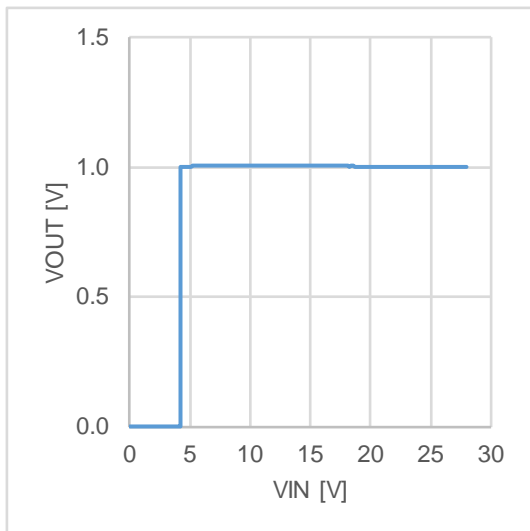

Figure 10. Line Regulation
(IO = 0mA)

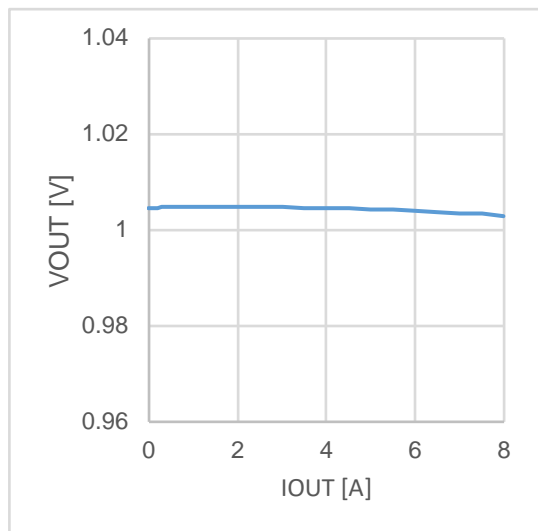

Figure 11. Load Regulation

Reference Application Curves – Cont'd

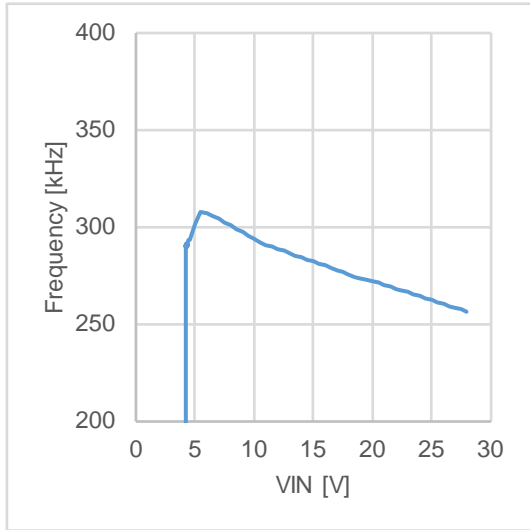

Figure 12. Switching Frequency vs VIN (IO = 1A)

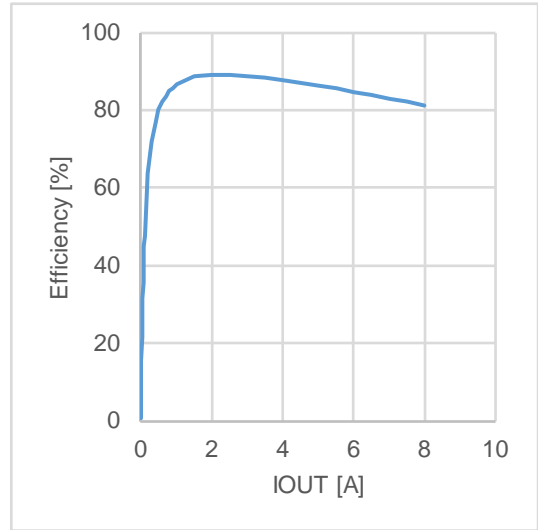

Figure 13. Efficiency vs Load Current

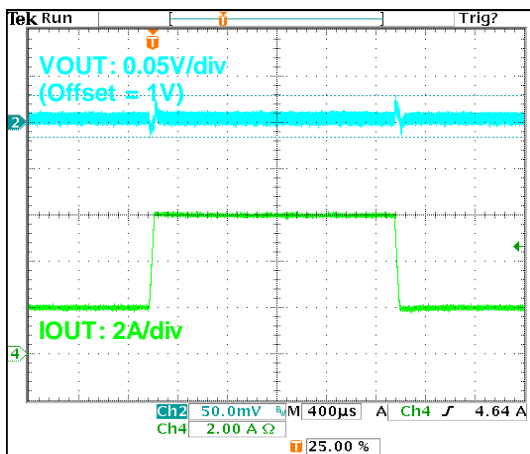

Figure 14. Load Response

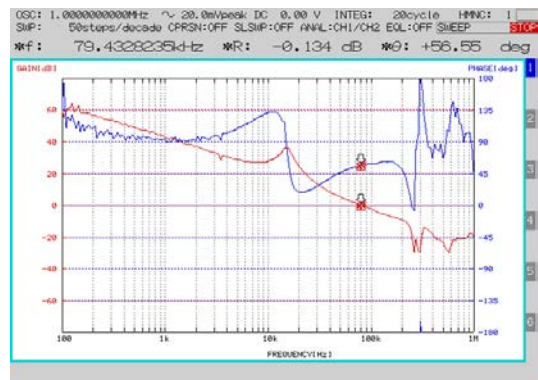

Figure 15. Frequency Response (IO = 8A)

Reference Application Curves – Cont'd

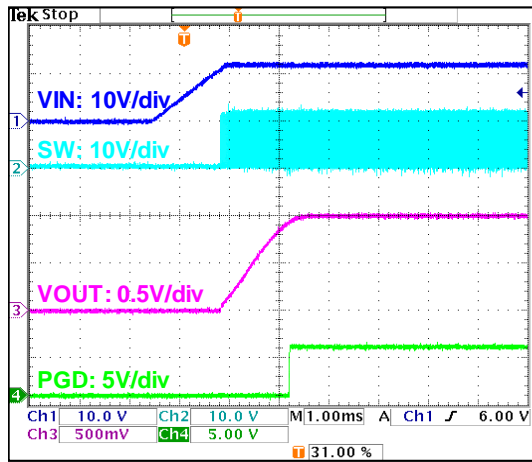

Figure 16. Start Up Waveform
(IO = 1A)

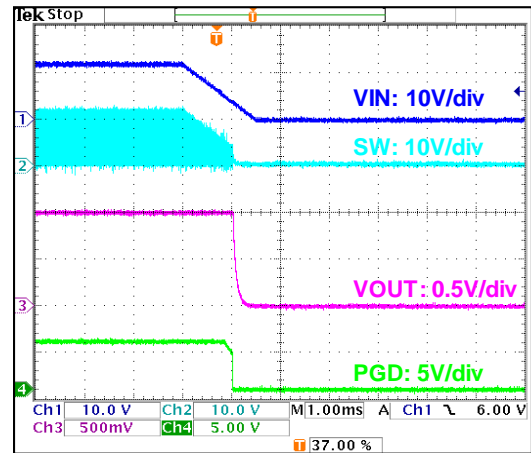

Figure 17. Shutdown Waveform
(IO = 1A)

Revision History

Date	Revision Number	Description
2020.10. 2	001	Initial release

General Precaution

1. Before you use our Products, you are requested to carefully read this document and fully understand its contents. ROHM shall not be in any way responsible or liable for failure, malfunction or accident arising from the use of any ROHM's Products against warning, caution or note contained in this document.
2. All information contained in this document is current as of the issuing date and subject to change without any prior notice. Before purchasing or using ROHM's Products, please confirm the latest information with a ROHM sales representative.
3. The information contained in this document is provided on an "as is" basis and ROHM does not warrant that all information contained in this document is accurate and/or error-free. ROHM shall not be in any way responsible or liable for any damages, expenses or losses incurred by you or third parties resulting from inaccuracy or errors of or concerning such information.

单击下面可查看定价，库存，交付和生命周期等信息

[>>ROHM Semiconductor\(罗姆\)](#)