

Description

The 5KP Series is designed specifically to protect sensitive electronic equipment from voltage transients induced by lightning and other transient voltage events.

Features

- I Fast response time
- I Matte tin lead-free Plated
- I Low incremental surge resistance
- I Halogen free and RoHS compliant
- I Typical I_R less than 2 μ A above 10V
- I Compatible with industrial standard package P600
- I For surface mounted applications to optimize board space
- I 5000W peak pulse power capability with at 10/1000 μ s waveform, repetition rate (duty cycle): 0.01%
- I High temperature soldering guaranteed:260°C/10 seconds



Electrical symbol

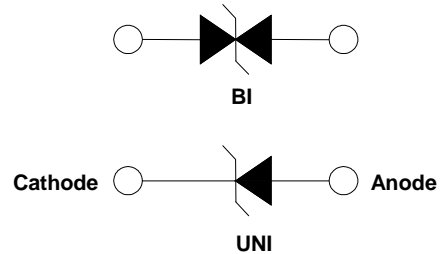

Part Number Code

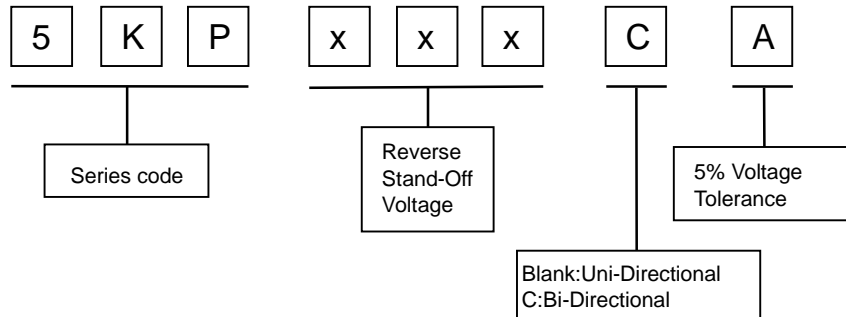

Mechanical Characteristics

Rating	Symbol	Value	Units
Peak Pulse Power Dissipation by 10x1000 μ s test Waveform (Note1)(Fig. 2)	P_{PP}	5000	W
Steady State Power Dissipation on infinite heat sink at $T_L=75^\circ\text{C}$ (Fig. 6)	P_D	8.0	W
Peak Forward Surge Current, 8.3ms Single Half Sine Wave Unidirectional only (Note 2)	I_{FSM}	500	A
Maximum instantaneous forward voltage at 100 A for unidirectional only	V_F	3.5/5.0	V
Operating junction and Storage Temperature Range.	T_J, T_{STG}	-55 to 150	$^\circ\text{C}$

Notes:

1. Non-repetitive current pulse , per Fig. 4 and derated above $T_A = 25^\circ\text{C}$ per Fig. 3.
2. Measured on 8.3ms single half sine wave or equivalent square wave, duty cycle=4 pulses per minute maximum.



Electrical Characteristics

Type Number		Reverse Stand-Off Voltage	Breakdown Voltage		Test Current	Max. Clamping Voltage 10/1000µs	Max. Peak Pulse Current 10/1000µs	Reverse Leakage
			V _{BR} @I _T					
		V _{RWM}	Min	Max	I _T	V _C @I _{PP}	I _{PP}	I _R @V _{RWM}
UNI	BI	V	V	V	mA	V	A	µA
5KP5.0A	5KP5.0CA	5.0	6.40	7.00	50	9.2	543.48	5000
5KP6.0A	5KP6.0CA	6.0	6.67	7.37	50	10.3	485.44	5000
5KP6.5A	5KP6.5CA	6.5	7.22	7.98	50	11.2	446.43	2000
5KP7.0A	5KP7.0CA	7.0	7.78	8.60	50	12.0	416.67	1000
5KP7.5A	5KP7.5CA	7.5	8.33	9.21	5	12.9	387.60	250
5KP8.0A	5KP8.0CA	8.0	8.89	9.83	5	13.6	367.65	150
5KP8.5A	5KP8.5CA	8.5	9.44	10.40	5	14.4	347.22	50
5KP9.0A	5KP9.0CA	9.0	10.00	11.10	5	15.4	324.68	20
5KP10A	5KP10CA	10.0	11.10	12.30	5	17.0	294.12	15
5KP11A	5KP11CA	11.0	12.20	13.50	5	18.2	274.73	2
5KP12A	5KP12CA	12.0	13.30	14.70	5	19.9	251.26	2
5KP13A	5KP13CA	13.0	14.40	15.90	5	21.5	232.56	2
5KP14A	5KP14CA	14.0	15.60	17.20	5	23.2	215.52	2
5KP15A	5KP15CA	15.0	16.70	18.50	5	24.4	204.92	2
5KP16A	5KP16CA	16.0	17.80	19.70	5	26.0	192.31	2
5KP17A	5KP17CA	17.0	18.90	20.90	5	27.6	181.16	2
5KP18A	5KP18CA	18.0	20.00	22.10	5	29.2	171.23	2
5KP19A	5KP19CA	19.0	21.10	23.30	5	30.8	162.44	2
5KP20A	5KP20CA	20.0	22.20	24.50	5	32.4	154.32	2
5KP22A	5KP22CA	22.0	24.40	26.90	5	35.5	140.85	2
5KP24A	5KP24CA	24.0	26.70	29.50	5	38.9	128.53	2
5KP26A	5KP26CA	26.0	28.90	31.90	5	42.1	118.76	2
5KP28A	5KP28CA	28.0	31.10	34.40	5	45.4	110.13	2
5KP30A	5KP30CA	30.0	33.30	36.80	5	48.4	103.31	2
5KP33A	5KP33CA	33.0	36.70	40.60	5	53.3	93.81	2
5KP36A	5KP36CA	36.0	40.00	44.20	5	58.1	86.06	2
5KP40A	5KP40CA	40.0	44.40	49.10	5	64.5	77.52	2
5KP43A	5KP43CA	43.0	47.80	52.80	5	69.4	72.05	2
5KP45A	5KP45CA	45.0	50.00	55.30	5	72.7	68.78	2
5KP48A	5KP48CA	48.0	53.30	58.90	5	77.4	64.60	2
5KP51A	5KP51CA	51.0	56.70	62.70	5	82.4	60.68	2
5KP54A	5KP54CA	54.0	60.00	66.30	5	87.1	57.41	2



Electrical Characteristics

Type Number		Reverse Stand-Off Voltage	Breakdown Voltage		Test Current	Max. Clamping Voltage 10/1000µs	Max. Peak Pulse Current 10/1000µs	Reverse Leakage
			V _{BR} @I _T					
		V _{RWM}	Min	Max	I _r	V _C @I _{PP}	I _{PP}	I _r @V _{RWM}
UNI	BI	V	V	V	mA	V	A	µA
5KP58A	5KP58CA	58.0	64.40	71.20	5	93.6	53.42	2
5KP60A	5KP60CA	60.0	66.70	73.70	5	96.8	51.65	2
5KP64A	5KP64CA	64.0	71.10	78.60	5	103.0	48.54	2
5KP70A	5KP70CA	70.0	77.80	86.00	5	113.0	44.25	2
5KP75A	5KP75CA	75.0	83.30	92.10	5	121.0	41.32	2
5KP78A	5KP78CA	78.0	86.70	95.80	5	126.0	39.68	2
5KP80A	5KP80CA	80.0	88.80	97.60	5	129.6	38.58	2
5KP85A	5KP85CA	85.0	94.40	104.00	5	137.0	36.50	2
5KP90A	5KP90CA	90.0	100.00	111.00	5	146.0	34.25	2
5KP100A	5KP100CA	100.0	111.00	123.00	5	162.0	30.86	2
5KP110A	5KP110CA	110.0	122.00	135.00	5	177.0	28.25	2
5KP120A	5KP120CA	120.0	133.00	147.00	5	193.0	25.91	2
5KP130A	5KP130CA	130.0	144.00	159.00	5	209.0	23.92	2
5KP140A	5KP140CA	140.0	155.00	171.00	5	226.8	22.05	2
5KP150A	5KP150CA	150.0	167.00	185.00	5	243.0	20.58	2
5KP160A	5KP160CA	160.0	178.00	197.00	5	259.0	19.31	2
5KP170A	5KP170CA	170.0	189.00	209.00	5	275.0	18.18	2
5KP180A	5KP180CA	180.0	200.00	220.00	5	291.6	17.15	2
5KP190A	5KP190CA	190.0	211.00	232.00	5	307.8	16.24	2
5KP200A	5KP200CA	200.0	224.00	247.0	5	324.0	15.43	2
5KP210A	5KP210CA	210.0	233.00	258.0	5	349.5	14.31	2
5KP220A	5KP220CA	220.0	246.00	272.0	5	356.0	14.04	2
5KP250A	5KP250CA	250.0	279.00	309.0	5	405.0	12.35	2
5KP300A	5KP300CA	300.0	335.00	371.0	5	486.0	10.29	2
5KP350A	5KP350CA	350.0	391.00	432.0	5	567.0	8.82	2
5KP400A	5KP400CA	400.0	447.00	494.0	5	648.0	7.72	2
5KP440A	5KP440CA	440.0	492.00	543.0	5	713.0	7.01	2

Notes: For bidirectional type having V_R of 10V and less, the I_r limit is double.



I-V Curve Characteristics

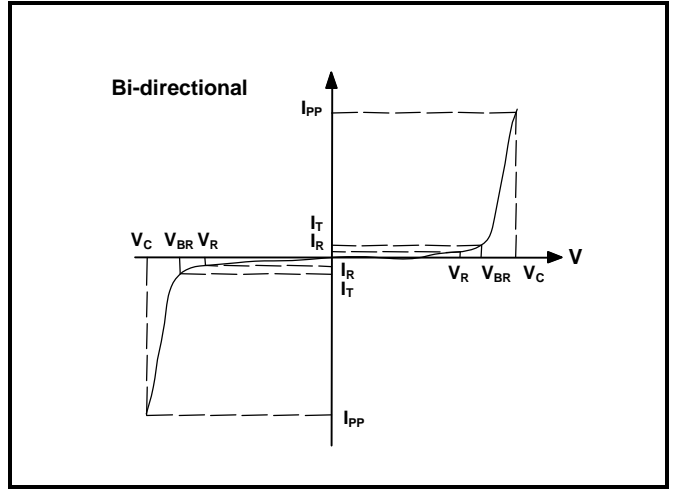
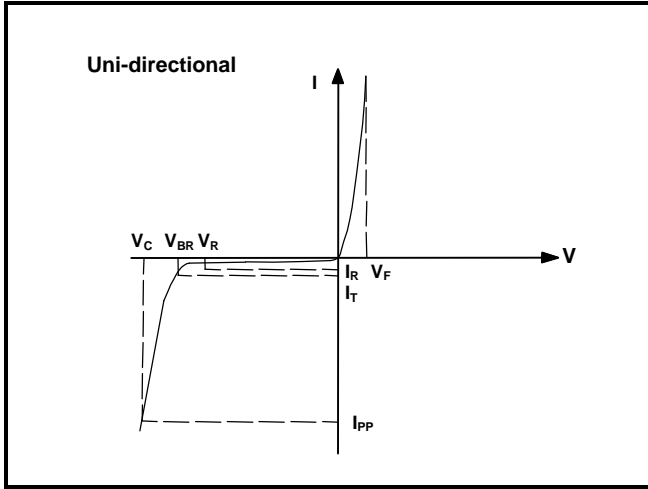

P_{PPM} Peak Pulse Power Dissipation -- Max power dissipation

V_R Stand-off Voltage -- Maximum voltage that can be applied to the TVS without operation

V_{BR} Breakdown Voltage -- Maximum voltage that flows through the TVS at a specified test current (I_T)

V_C Clamping Voltage -- Peak voltage measured across the TVS at a specified I_{ppm} (peak impulse current)

I_R Reverse Leakage Current – Current measured at V_R

V_F Forward Voltage Drop for Uni-directional

Ratings and Characteristic Curves ($T_A=25^\circ C$ unless otherwise noted)

Figure 1 - TVS Transients Clamping Waveform

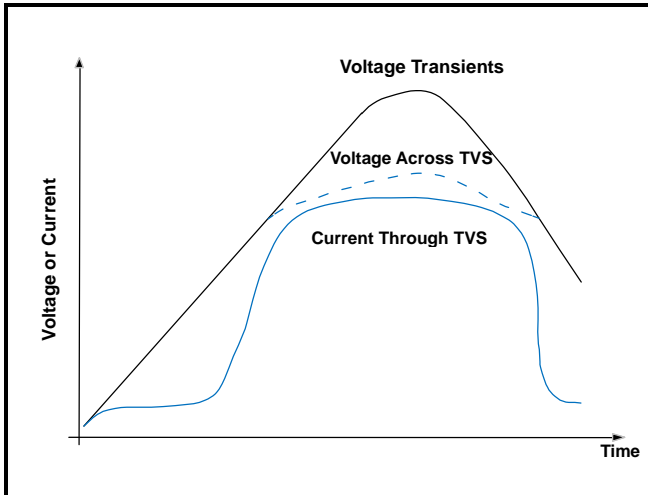

Figure 2 - Peak Pulse Power Rating Curve

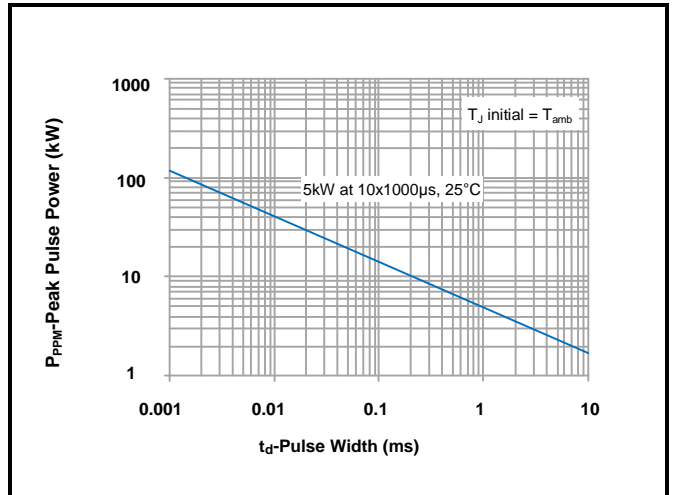

Figure 3 - Pulse Derating Curve

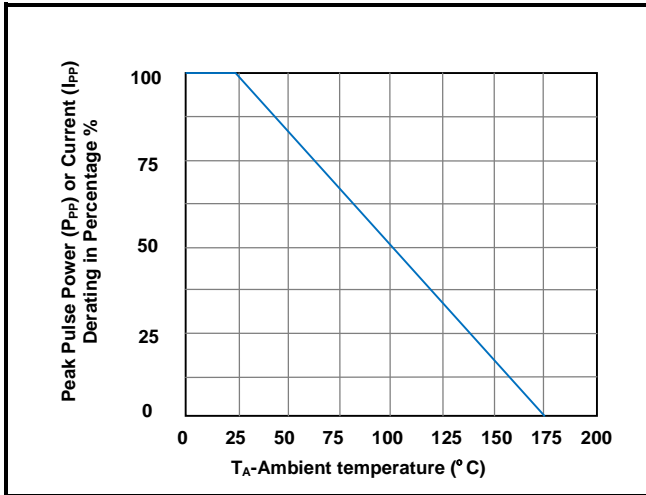

Figure 4 - Pulse Waveform

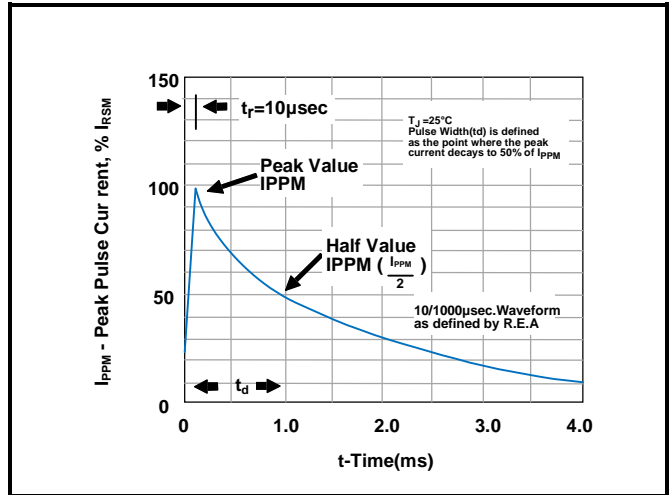

Figure 5 - Typical Junction Capacitance

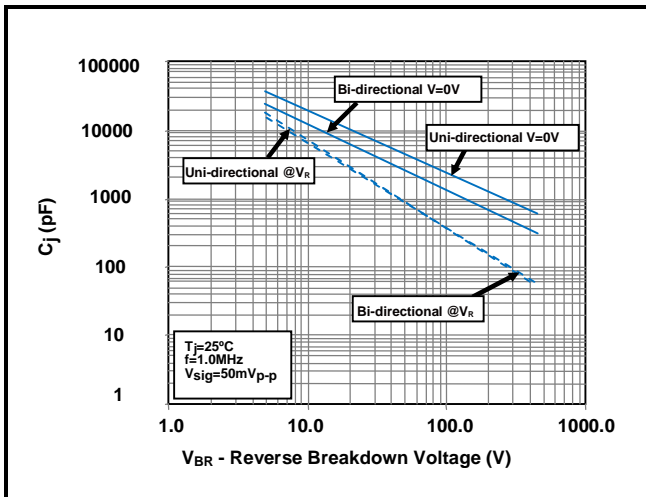

Figure 6 - Steady State Power Derating Curve

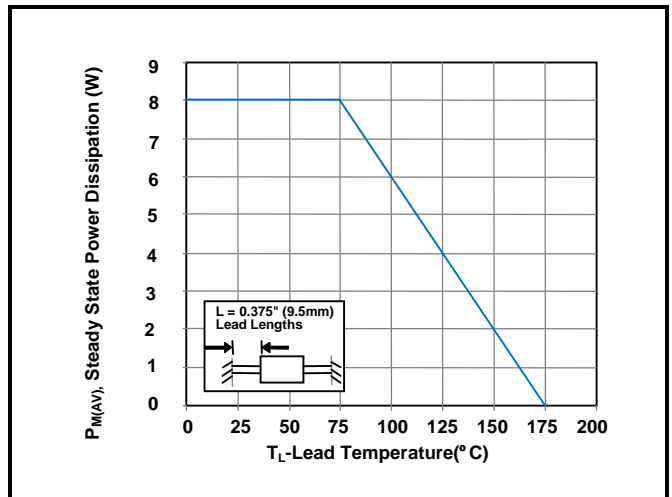
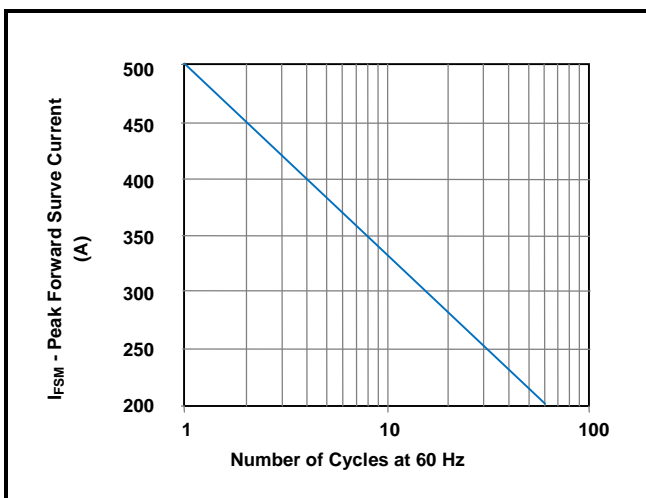
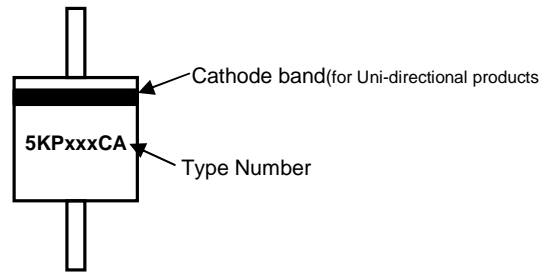

Figure 7 - Maximum Non-Repetitive Surge Current



Part Marking System



Dimensions

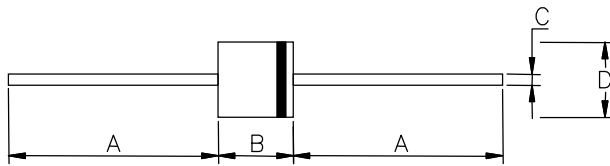

DIM	Millimeters		Inches	
	Min	Max	Min	Max
A	25.4	-	1.000	-
B	8.6	9.14	0.339	0.360
C	1.2	1.32	0.047	0.052
D	8.6	9.14	0.339	0.360

Packaging Information

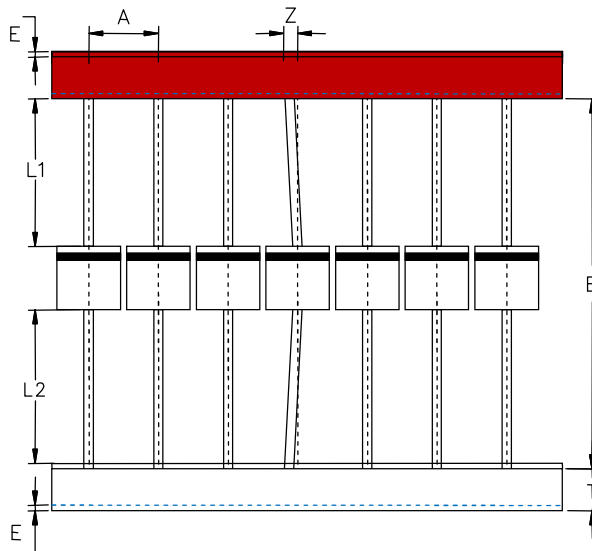

Symbol	Millimeters	Inches
A	10±0.5	0.394±0.019
B	53.0±1.0	2.087±0.039
Z	1.2Max	0.047 Max
T	6.0±0.5	0.236±0.019
E	0.8Max	0.031 Max
L1-L2	1.0Max	0.039 Max

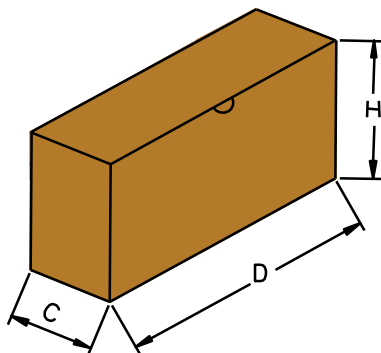

Symbol	Millimeters	Inches
D	257.0±5.0	10.118±0.197
C	80.0±5.0	3.15±0.197
H	149.0±5.0	5.866±0.197
Quantity	400PCS/ inner box	



单击下面可查看定价，库存，交付和生命周期等信息

[>>RUILON\(瑞隆源\)](#)