



TVS/ESD Arrays

RLSD32Axx1C Series

TVS/ESD Arrays - RLSD32Axx1C Series

Features

- 320 Watts Peak Pulse Power per Line (tp = 8/20µs)
- Working voltages:3.3V、 5V、 8V、 12V、 15V、 18V、 24V、 36V
- Low Leakage Current
- Low operating and clamping voltages
- Lead Free/RoHS compliant
- Solid-state silicon avalanche technology
- Provides ESD protection to IEC61000-4-2(ESD):
±15kV (air discharge)
±8kV (contact discharge);



Mechanical Characteristics

- SOD-323 package
- Molding compound flammability rating: UL 94V-0
- Quantity Per Reel :3,000pcs
- Reel Size : 7 inch
- Lead Finish : Lead Free

Applications

- Cell Phone Handsets and Accessories
- Microprocessor based equipment
- Personal Digital Assistants (PDA's)
- Notebooks, Desktops, and Servers
- Portable Instrumentation
- Pagers Peripherals

Pinout and Functional Block Diagram

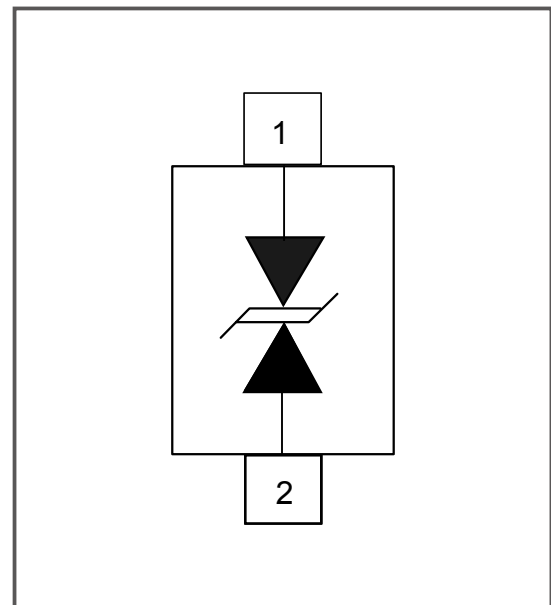

Part Number Code

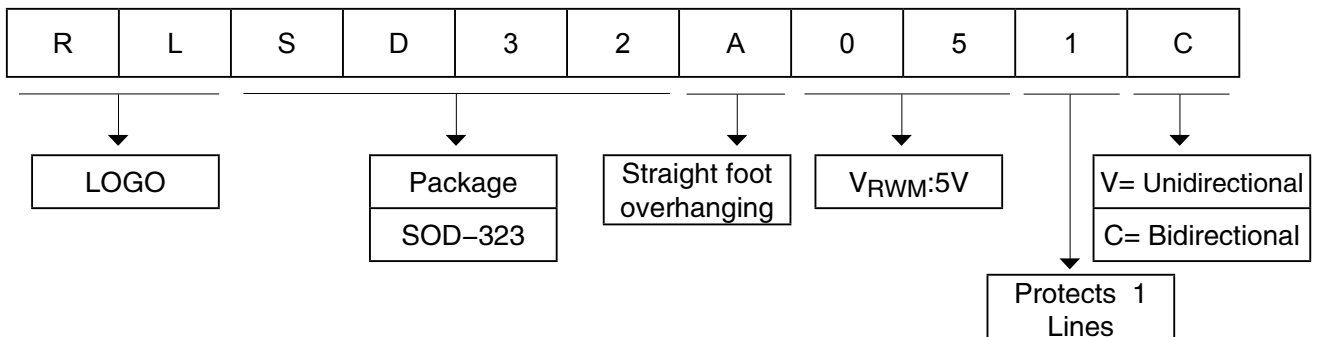

TVS/ESD Arrays - RLSD32Axx1C Series

Absolute Maximum Rating

Rating	Symbol	Value	Units
Peak Pulse Power (tp =8/20μs)	P _{PK}	320	Watts
ESD Voltage (Contact)	V _{ESD}	±8	Kv
ESD Voltage (Air)	V _{ESD}	±15	Kv
Lead Soldering Temperature	T _L	260 (10 sec.)	°C
Operating Temperature	T _J	-55 to +125	°C
Storage Temperature	T _{STG}	-55 to +150	°C

Electrical Parameters (T=25°C)

Symbol	Parameter
V _{RWM}	Working Peak Reverse Voltage
I _R	Maximum Reverse Leakage Current @ V _{RWM}
V _{BR}	Breakdown Voltage @ I _T
I _T	Test Current
I _F	Forward Current
V _F	Forward Voltage @ I _F

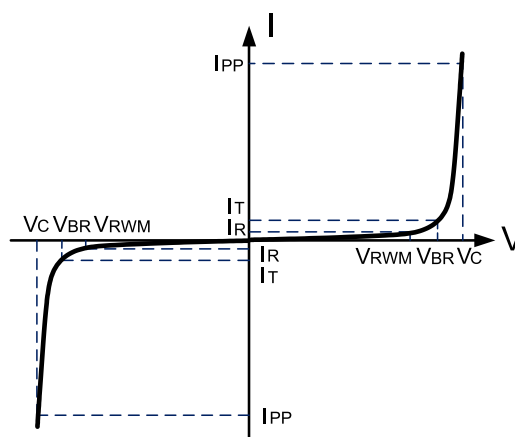

Electrical Characteristics(@ 25°C Unless Otherwise Specified)

Type Number	Reverse Stand-Off Voltage	Minimum Breakdown Voltage	Peak Pulse Voltage @8/20μS	Peak Pulse Current @8/20μS	Reverse Leakage @V _{RWM}	Typical Capacitance
	V _{RWM}	V _{BR} @1mA	V _C @1A	I _{PP}	I _R @V _{RWM}	DC=0V
	V	V	V	A	μA	C _J @ 1 MHz
RLSD32A031C	3.3	4	7.5	25	200	200
RLSD32A051C	5	6	9.8	24	10	150
RLSD32A081C	8	8.5	13.4	18	5	125
RLSD32A121C	12	13.3	19	13	1	110
RLSD32A151C	15	16.7	24	10	1	90
RLSD32A181C	18	19	29	8	1	75
RLSD32A241C	24	26.7	43	6	1	35
RLSD32A361C	36	40	60	4	1	25

TVS/ESD Arrays - RLSD32Axx1C Series

Characteristic Curves

Fig1. 8/20 μ s Pulse Waveform

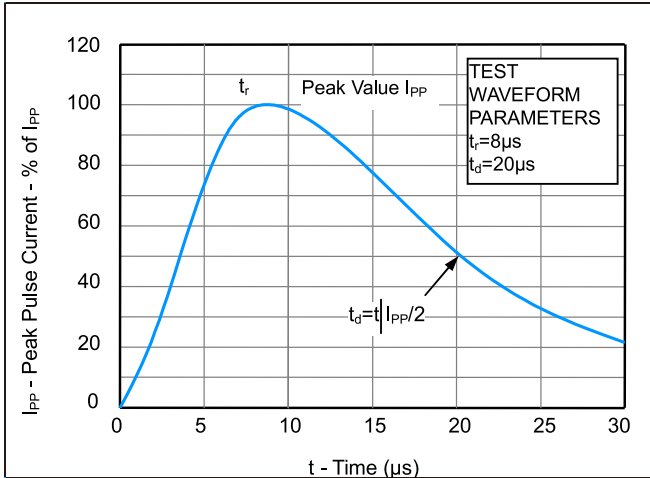

Fig2. ESD Pulse Waveform (according to IEC 61000-4-2)

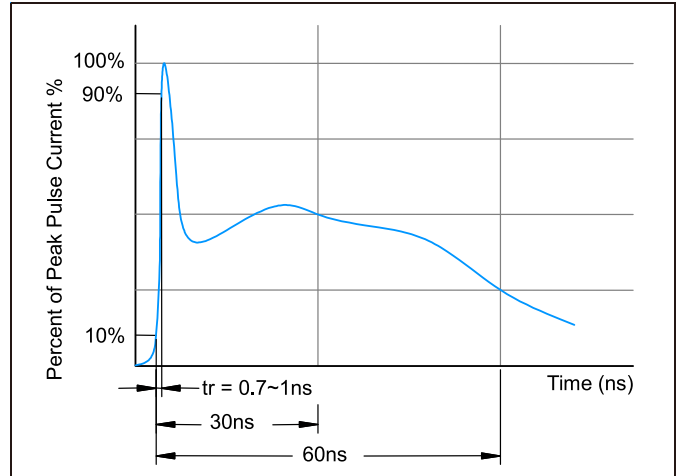

Fig3. Power Derating Curve

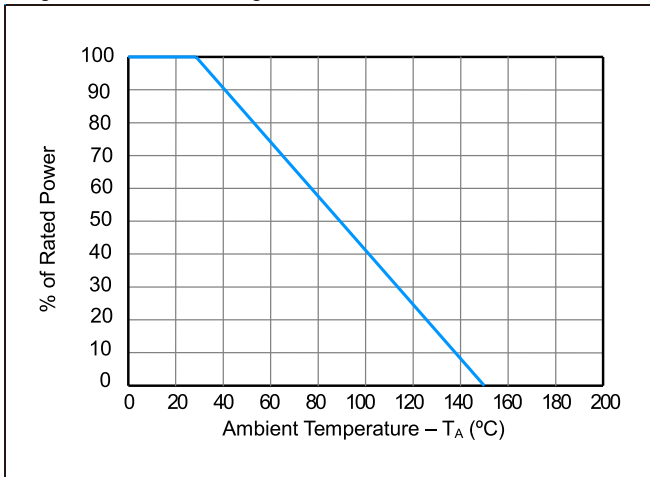
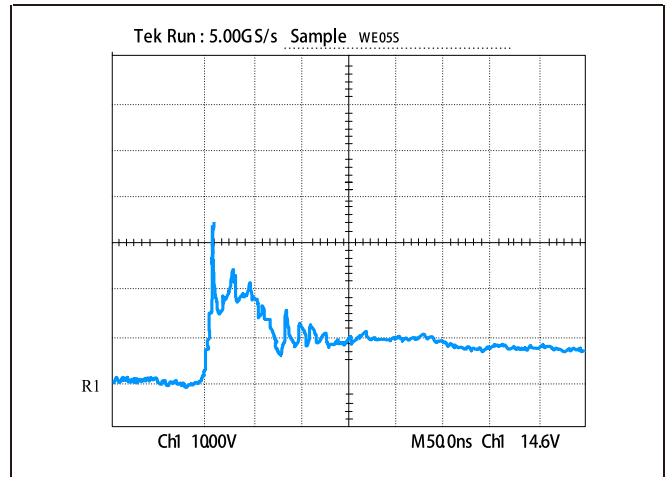
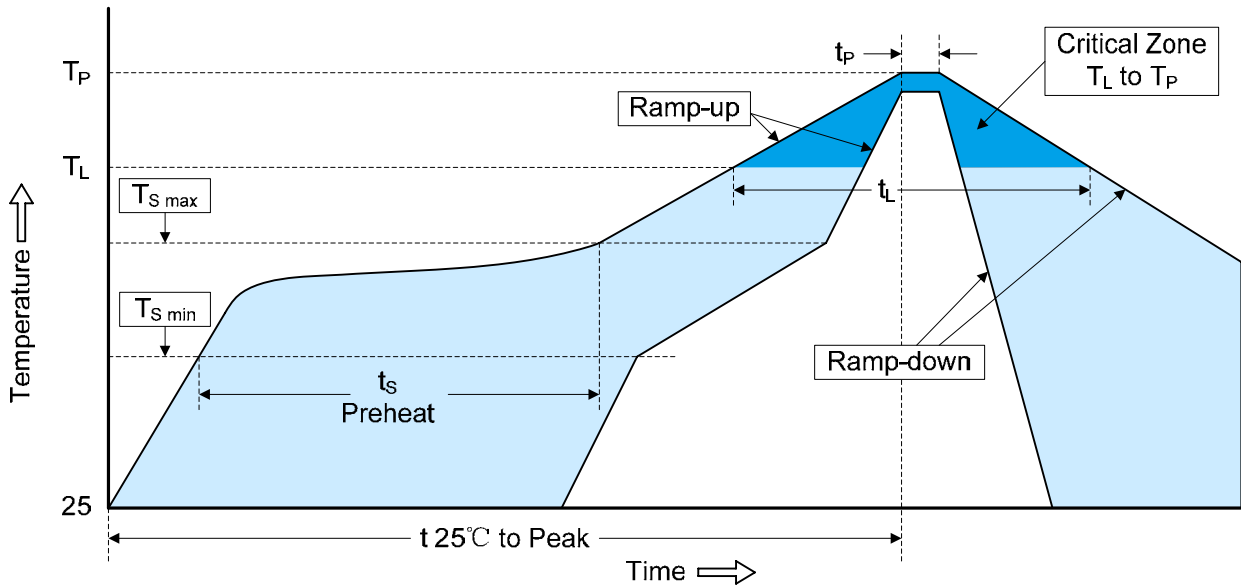

Figure 4: ESD Clamping (8kV Contact per IEC 61000-4-2)



TVS/ESD Arrays - RLSD32Axx1C Series

Recommended Soldering Conditions



Profile Feature	Pb-Free Assembly
Average ramp-up rate (T_L to T_P)	3°C/second max.
Preheat	150°C
-Temperature Min ($T_{S\ min}$)	200°C
-Temperature Max ($T_{S\ max}$)	60-180 seconds
-Time (min to max) (t_s)	
$T_{S\ max}$ to T_L	3°C/second max.
-Ramp-up Rate	
Time maintained above:	217°C
-Temperature (T_L)	60-150 seconds
-Time (t_L)	
Peak Temperature (T_P)	260°C
Time within 5°C of actual Peak Temperature (t_p)	20-40 seconds
Ramp-down Rate	6°C/second max.
Time 25°C to Peak Temperature	8 minutes max.

TVS/ESD Arrays - RLSD32Axx1C Series

Package dimension SOD-323

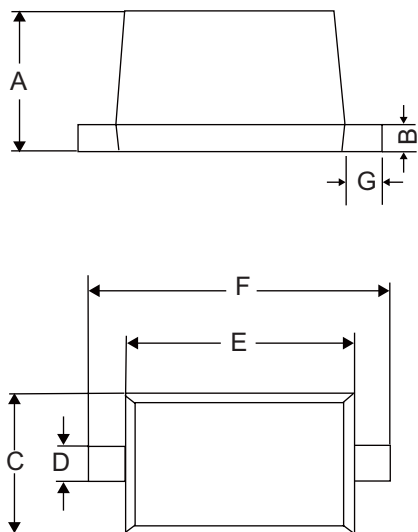

Symbol	Dimensions			
	Inches		Millimeters	
	Min	Max	Min	Max
A	---	0.043	---	1.1
B	0.004	0.010	0.10	0.25
C	0.045	0.054	1.2	1.4
D	0.012	0.016	0.3	0.4
E	0.060	0.071	1.5	1.8
F	0.090	0.107	2.3	2.7
G	0.006	0.010	0.15	0.25

单击下面可查看定价，库存，交付和生命周期等信息

[>>RUILON\(瑞隆源\)](#)