

# 10MHz, Precision, Rail-to-Rail I/O CMOS Operational Amplifier

## FEATURES

- **HIGH GAIN BANDWIDTH:10MHz**
- **RAIL-TO-RAIL INPUT AND OUTPUT**  
 $\pm 0.5\text{mV Max Vos (RS721P, RS722P)}$   
 $\pm 0.8\text{mV Max Vos (RS724P)}$
- **INPUT VOLTAGE RANGE: -0.2V to +5.7V**  
with  $V_s = 5.5\text{V}$
- **SUPPLY RANGE: +2.5V to +5.5V**
- **SPECIFIED UP TO +125°C**
- **Micro SIZE PACKAGES: SOT23-5, SOT353(SC70-5)**

## DESCRIPTION

The RS721P, RS722P, RS724P families of products offer low voltage operation and rail-to-rail input and output, as well as excellent speed/power consumption ratio, providing an excellent bandwidth (10MHz) and slew rate of 6V/us. The op-amps are unity gain stable and feature an ultra-low input bias current.

The RS721P, RS722P and RS724P has lower offset, which is guaranteed not upper than 0.5mV at 25°C with  $V_s = 5\text{V}$ ,  $V_{CM} = V_s/2$ .

## APPLICATIONS

- **SENSORS**
- **ACTIVE FILTERS**
- **TEST EQUIPMENT**
- **DRIVING A/D CONVERTERS**
- **PHOTODIODE AMPLIFICATION**

The devices are ideal for sensor interfaces, active filters and portable applications. The RS721P, RS722P, RS724P families of operational amplifiers are specified at the full temperature range of -40°C to +125°C under single or dual power supplies of 2.5V to 5.5V.

### Device Information <sup>(1)</sup>

PART NUMBER	PACKAGE	BODY SIZE(NOM)
RS721P	SOT23-5	2.90mm×1.60mm
	SOIC-8(SOP8)	4.90mm×3.90mm
	MSOP-8	3.00mm×3.00mm
	SOT353(SC70-5)	2.10mm×1.25mm
RS722P	SOIC-8(SOP8)	4.90mm×3.90mm
	MSOP-8	3.00mm×3.00mm
	TSSOP-8	3.00mm×4.40mm
	TDFN2×2-8L	2.00mm×2.00mm
RS724P	SOIC-14(SOP14)	8.65mm×3.90mm
	TSSOP-14	5.00mm×4.40mm

(1) For all available packages, see the orderable addendum at the end of the data sheet.

## Revision History

Note: Page numbers for previous revisions may differ from page numbers in the current version.

VERSION	Change Date	Change Item
C.1	2021/11/12	1. Update Package Qty on Page 6@RevB.5 2. Added TAPE AND REEL INFORMATION

### Pin Configuration and Functions (Top View)

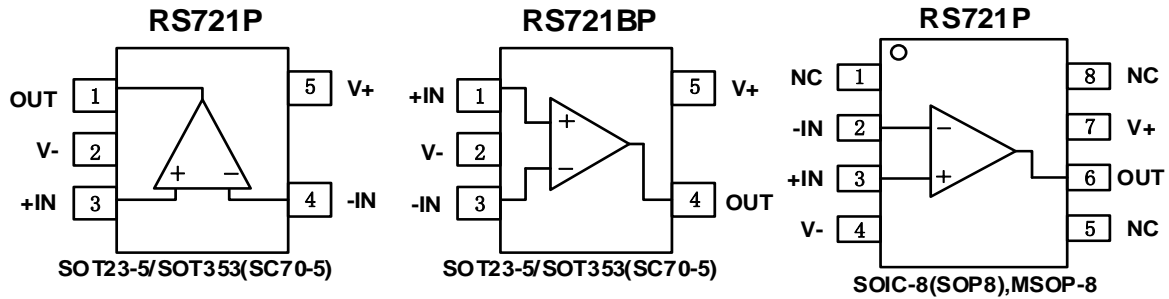

### Pin Description

NAME	PIN			I/O	DESCRIPTION
	RS721P	RS721BP	RS721P		
	SOT23-5/ SOT353(SC70-5)	SOT23-5/ SOT353(SC70-5)	SOIC-8(SOP8)/ MSOP8		
-IN	4	3	2	I	Negative (inverting) input
+IN	3	1	3	I	Positive (noninverting) input
NC	-	-	1,5,8	-	No internal connection (can be left floating)
OUT	1	4	6	O	Output
V-	2	2	4	-	Negative (lowest) power supply
V+	5	5	7	-	Positive (highest) power supply

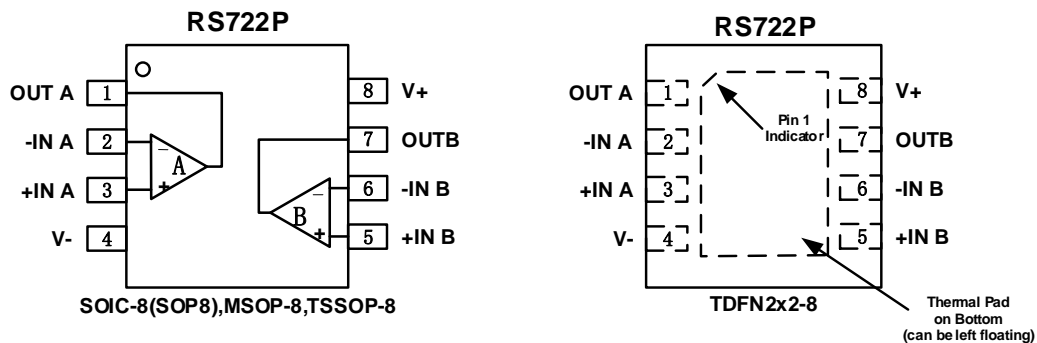

### Pin Description

NAME	PIN		I/O	DESCRIPTION
	SOIC-8(SOP8)/MSOP8/TSSOP-8/TDFN2x2-8			
-INA	2		I	Inverting input, channel A
+INA	3		I	Noninverting input, channel A
-INB	6		I	Inverting input, channel B
+INB	5		I	Noninverting input, channel B
OUTA	1		O	Output, channel A
OUTB	7		O	Output, channel B
V-	4		-	Negative (lowest) power supply
V+	8		-	Positive (highest) power supply

## Pin Configuration and Functions (Top View)

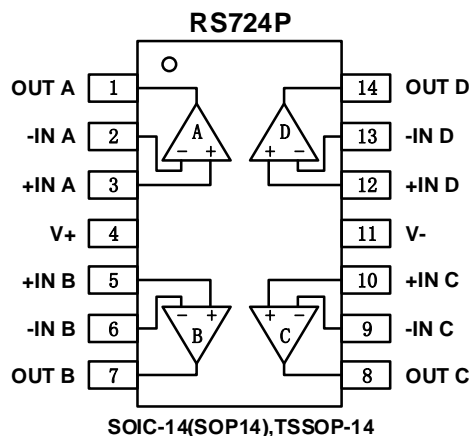

### Pin Description

NAME	PIN	I/O	DESCRIPTION
	SOIC-14(SOP14)/TSSOP-14		
-INA	2	I	Inverting input, channel A
+INA	3	I	Noninverting input, channel A
-INB	6	I	Inverting input, channel B
+INB	5	I	Noninverting input, channel B
-INC	9	I	Inverting input, channel C
+INC	10	I	Noninverting input, channel C
-IND	13	I	Inverting input, channel D
+IND	12	I	Noninverting input, channel D
OUTA	1	O	Output, channel A
OUTB	7	O	Output, channel B
OUTC	8	O	Output, channel C
OUTD	14	O	Output, channel D
V-	11	-	Negative (lowest) power supply
V+	4	-	Positive (highest) power supply

## SPECIFICATIONS

### Absolute Maximum Ratings

Over operating free-air temperature range (unless otherwise noted) <sup>(1)</sup>

		MIN	MAX	UNIT
Voltage	Supply, $V_s=(V+) - (V-)$		7	V
	Signal input pin <sup>(2)</sup>	(V-)-0.5	(V+) + 0.5	
	Signal output pin <sup>(3)</sup>	(V-)-0.5	(V+) + 0.5	
Current	Signal input pin <sup>(2)</sup>	-10	10	mA
	Signal output pin <sup>(3)</sup>	-150	150	mA
	Output short-circuit <sup>(4)</sup>	Continuous		
Temperature	Operating range, $T_A$	-40	125	°C
	Junction, $T_J$	-40	150	
	Storage, $T_{stg}$	-65	150	

(1) Stresses above these ratings may cause permanent damage. Exposure to absolute maximum conditions for extended periods may degrade device reliability. These are stress ratings only, and functional operation of the device at these or any other conditions beyond those specified is not implied.

(2) Input terminals are diode-clamped to the power-supply rails. Input signals that can swing more than 0.5V beyond the supply rails should be current-limited to 10mA or less.

(3) Output terminals are diode-clamped to the power-supply rails. Output signals that can swing more than 0.5V beyond the supply rails should be current-limited to  $\pm 150$ mA or less.

(4) Short-circuit to ground, one amplifier per package.

### ESD Ratings

			VALUE	UNIT
$V_{(ESD)}$	Electrostatic discharge	Human-body model (HBM)	$\pm 3000$	V
		Machine Model (MM)	$\pm 200$	

### Recommended Operating Conditions

Over operating free-air temperature range (unless otherwise noted)

		MIN	NOM	MAX	UNIT
Supply voltage, $V_s= (V+) - (V-)$	Signal-supply	2.5		5.5	V
	Dual-supply	$\pm 1.25$		$\pm 2.75$	

### Thermal Information: RS721P

THERMAL METRIC		RS721P				UNIT
		5PINS		8PINS		
		SOT23-5	SOT353 (SC70-5)	SOIC-8	MSOP8	
$R_{\theta JA}$	Junction-to-ambient thermal resistance	273.8	214.7	116	165	°C/W
$R_{\theta JC(top)}$	Junction-to-case(top) thermal resistance	126.8	127.1	60	53	°C/W
$R_{\theta JB}$	Junction-to-board thermal resistance	85.9	60.0	56	87	°C/W
$\Psi_{JT}$	Junction-to-top characterization parameter	10.9	33.4	12.8	4.9	°C/W
$\Psi_{JB}$	Junction-to-board characterization parameter	84.9	59.8	98.3	85	°C/W
$R_{\theta JC(bot)}$	Junction-to-case(bottom) thermal resistance	N/A	N/A	N/A	N/A	°C/W

**Thermal Information: RS722P**

THERMAL METRIC		RS722P				UNIT
		8PINS				
		SOIC-8	MSOP8	TSSOP-8	TDFN2×2-8L	
$R_{\theta JA}$	Junction-to-ambient thermal resistance	116	165	192	80.1	°C/W
$R_{\theta JC(top)}$	Junction-to-case(top) thermal resistance	60	53	64.3	100	°C/W
$R_{\theta JB}$	Junction-to-board thermal resistance	56	87	105.3	45	°C/W
$\Psi_{JT}$	Junction-to-top characterization parameter	12.8	4.9	7.6	6.8	°C/W
$\Psi_{JB}$	Junction-to-board characterization parameter	98.3	85	105.5	45.2	°C/W
$R_{\theta JC(bot)}$	Junction-to-case(bottom) thermal resistance	N/A	N/A	N/A	22.7	°C/W

**Thermal Information: RS724P**

THERMAL METRIC		RS724P		UNIT
		14PINS		
		SOIC-14	TSSOP-14	
$R_{\theta JA}$	Junction-to-ambient thermal resistance	83.8	120.8	°C/W
$R_{\theta JC(top)}$	Junction-to-case(top) thermal resistance	70.7	34.3	°C/W
$R_{\theta JB}$	Junction-to-board thermal resistance	59.5	62.8	°C/W
$\Psi_{JT}$	Junction-to-top characterization parameter	11.6	1	°C/W
$\Psi_{JB}$	Junction-to-board characterization parameter	37.7	56.5	°C/W
$R_{\theta JC(bot)}$	Junction-to-case(bottom) thermal resistance	N/A	N/A	°C/W

**PACKAGE/ORDERING INFORMATION**

Orderable Device	Package Type	Pin	Channel	Op Temp(°C)	Device Marking	Package Qty
RS721PXF	SOT23-5	5	1	-40°C ~125°C	721P	Tape and Reel,3000
RS721PXC5	SOT353(SC70-5)	5	1	-40°C ~125°C	721P	Tape and Reel,3000
RS721BPXF	SOT23-5	5	1	-40°C ~125°C	721BP	Tape and Reel,3000
RS721BPXC5	SOT353(SC70-5)	5	1	-40°C ~125°C	721BP	Tape and Reel,3000
RS721PXK	SOIC-8(SOP8)	8	1	-40°C ~125°C	RS721P	Tape and Reel,4000
RS721PXM	MSOP-8	8	1	-40°C ~125°C	RS721P	Tape and Reel,4000
RS722PXK	SOIC-8(SOP8)	8	2	-40°C ~125°C	RS722P	Tape and Reel,4000
RS722PXM	MSOP-8	8	2	-40°C ~125°C	RS722P	Tape and Reel,4000
RS722PXQ	TSSOP-8	8	2	-40°C~125°C	RS722P	Tape and Reel,4000
RS722PXTDE8	TDFN2x2-8L	8	2	-40°C ~125°C	RS722P	Tape and Reel,3000
RS724PXP	SOIC-14(SOP14)	14	4	-40°C ~125°C	RS724P	Tape and Reel,4000
RS724PXQ	TSSOP-14	14	4	-40°C ~125°C	RS724P	Tape and Reel,4000

## ELECTRICAL CHARACTERISTICS

(At  $T_A = +25^\circ\text{C}$ ,  $V_S = 5\text{V}$ ,  $R_L = 10\text{k}\Omega$  connected to  $V_S/2$ , and  $V_{OUT} = V_S/2$ , unless otherwise noted.)

PARAMETER		CONDITIONS	$T_J$	RS721P, RS722P, RS724P			
				MIN	TYP	MAX	UNIT
<b>POWER SUPPLY</b>							
$V_S$	Operating Voltage Range		$25^\circ\text{C}$	2.5		5.5	V
$I_Q$	Quiescent Current/Amplifier		$25^\circ\text{C}$		1.1	1.55	mA
PSRR	Power-Supply Rejection Ratio	$V_S = 2.5\text{V to } 5.5\text{V}$ , $V_{CM} = (V_-) + 0.5\text{V}$	$25^\circ\text{C}$	75	97		dB
			$-40^\circ\text{C to } 125^\circ\text{C}$	65			
$t_{ON}$	Turn-on Time		$25^\circ\text{C}$		12		us
<b>INPUT</b>							
$V_{OS}$	Input Offset Voltage	$V_{CM} = V_S/2$ , RS721P	$25^\circ\text{C}$	-0.5	$\pm 0.2$	0.5	mV
		$V_{CM} = V_S/2$ , RS722P	$25^\circ\text{C}$	-0.5	$\pm 0.2$	0.5	mV
		$V_{CM} = V_S/2$ , RS724P	$25^\circ\text{C}$	-0.8	$\pm 0.3$	0.8	mV
$V_{OS} T_C$	Input Offset Voltage Average Drift		$-40^\circ\text{C to } 125^\circ\text{C}$		$\pm 2.6$		$\mu\text{V}/^\circ\text{C}$
$I_B$	Input Bias Current		$25^\circ\text{C}$		$\pm 1$	$\pm 10$	pA
$I_{OS}$	Input Offset Current		$25^\circ\text{C}$		$\pm 1$	$\pm 10$	pA
$V_{CM}$	Common-Mode Voltage Range	$V_S = 5.5\text{V}$	$25^\circ\text{C}$	-0.2		5.7	V
CMRR	Common-Mode Rejection Ratio	$V_S = 5.5\text{V}$ , $V_{CM} = -0.2\text{V to } 4\text{V}$	$25^\circ\text{C}$	77	97		dB
			$-40^\circ\text{C to } 125^\circ\text{C}$	70			
		$V_S = 5.5\text{V}$ , $V_{CM} = -0.2\text{V to } 5.7\text{V}$	$25^\circ\text{C}$	65	82		
			$-40^\circ\text{C to } 125^\circ\text{C}$	60			
<b>OUTPUT</b>							
$A_{OL}$	Open-Loop Voltage Gain	$R_L = 2\text{k}\Omega$ , $V_O = 0.15\text{V to } 4.85\text{V}$	$25^\circ\text{C}$	86	105		dB
			$-40^\circ\text{C to } 125^\circ\text{C}$	65			
		$R_L = 10\text{k}\Omega$ , $V_O = 0.05\text{V to } 4.95\text{V}$	$25^\circ\text{C}$	96	110		
			$-40^\circ\text{C to } 125^\circ\text{C}$	75			
	Output Swing From Rail	$R_L = 2\text{k}\Omega$	$25^\circ\text{C}$		52		mV
		$R_L = 10\text{k}\Omega$			7		
$I_{OUT}$	Output Current Source		$25^\circ\text{C}$		140		mA
<b>FREQUENCY RESPONSE</b>							
SR	Slew Rate		$25^\circ\text{C}$		6		V/us
GBP	Gain-Bandwidth Product		$25^\circ\text{C}$		10		MHz
PM	Phase Margin		$25^\circ\text{C}$		62		$^\circ$
$t_s$	Setting Time, 0.1%		$25^\circ\text{C}$		0.5		us
	Overload Recovery Time	$V_{IN} \cdot \text{Gain} \geq V_S$	$25^\circ\text{C}$		3.2		us
<b>NOISE</b>							
$e_n$	Input Voltage Noise Density	$f = 1\text{KHz}$	$25^\circ\text{C}$		9.5		$\text{nV}/\sqrt{\text{Hz}}$
		$f = 10\text{KHz}$	$25^\circ\text{C}$		6.5		$\text{nV}/\sqrt{\text{Hz}}$



## TYPICAL CHARACTERISTICS

At  $T_A = +25^\circ\text{C}$ ,  $V_S = 5\text{V}$ ,  $R_L = 10\text{k}\Omega$  connected to  $V_S/2$ ,  $V_{OUT} = V_S/2$ , unless otherwise noted.

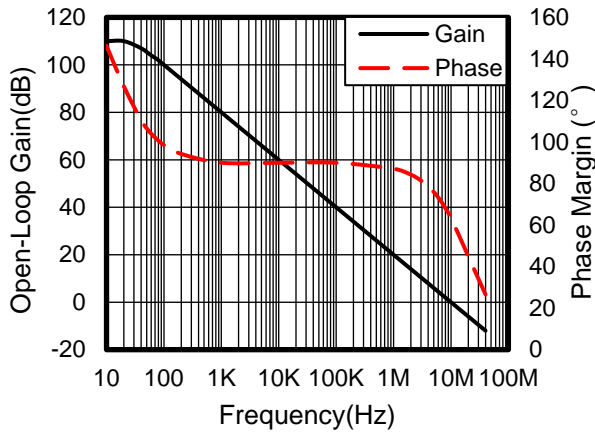

Figure 1. Open-loop Gain and Phase vs Frequency

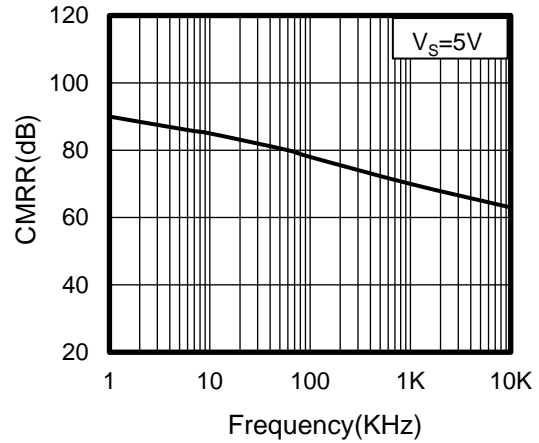

Figure 2. Common-Mode Rejection Ratio vs Frequency

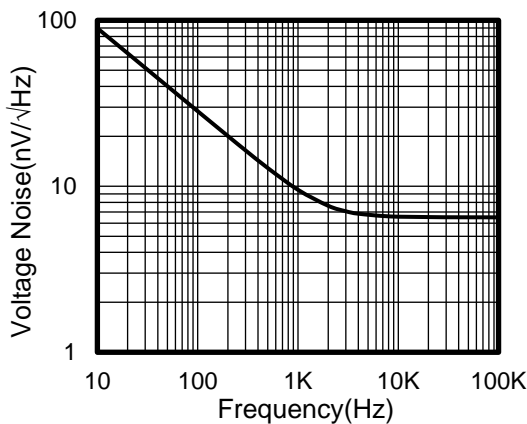

Figure 3. Input Voltage Noise Spectral Density vs Frequency

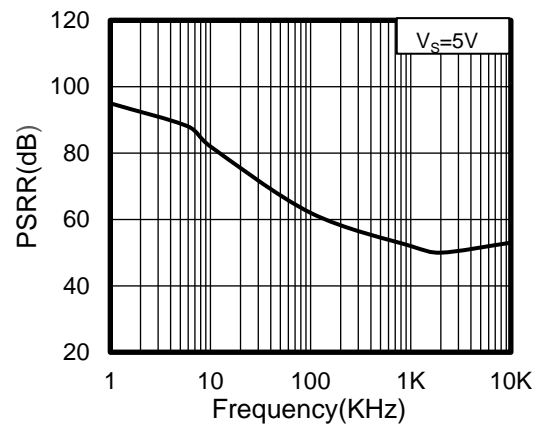

Figure 4. Power-Supply Rejection Ratio vs Frequency

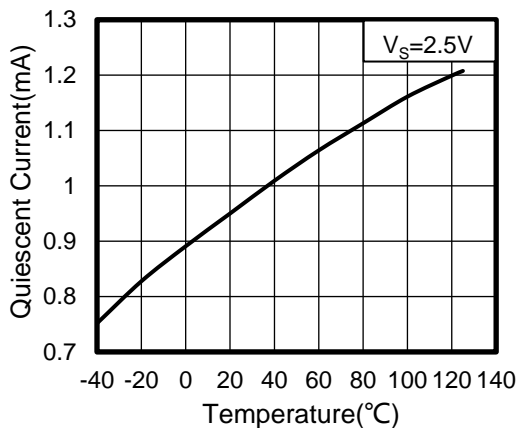

Figure 5. Quiescent Current vs Temperature

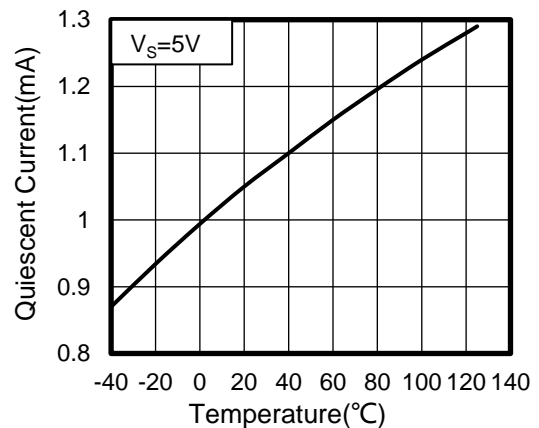
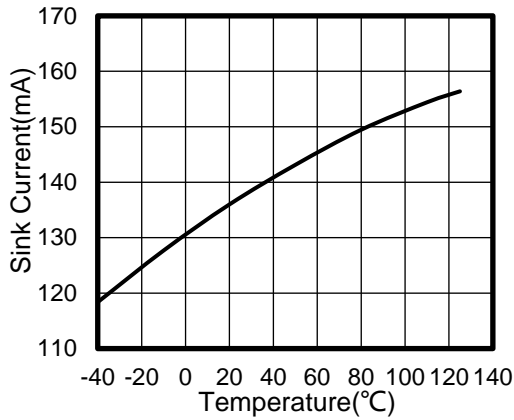

Figure 6. Quiescent Current vs Temperature

## TYPICAL CHARACTERISTICS

At  $T_A = +25^\circ\text{C}$ ,  $V_S = 5\text{V}$ ,  $R_L = 10\text{k}\Omega$  connected to  $V_S/2$ ,  $V_{OUT} = V_S/2$ , unless otherwise noted.



**Figure 7. Sink Current vs Temperature**

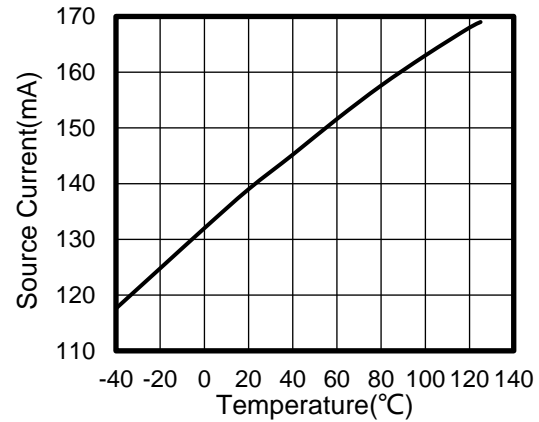

**Figure 8. Source Current vs Temperature**

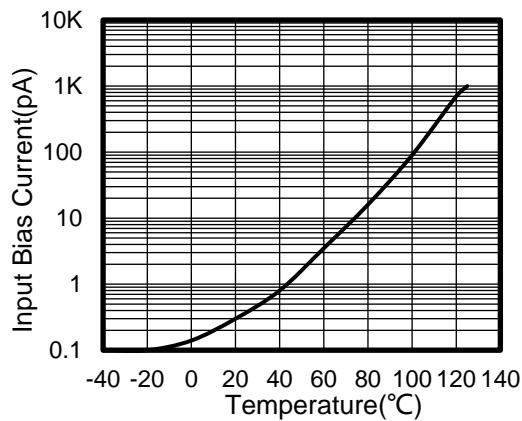

**Figure 9. Input Bias Current vs Temperature**

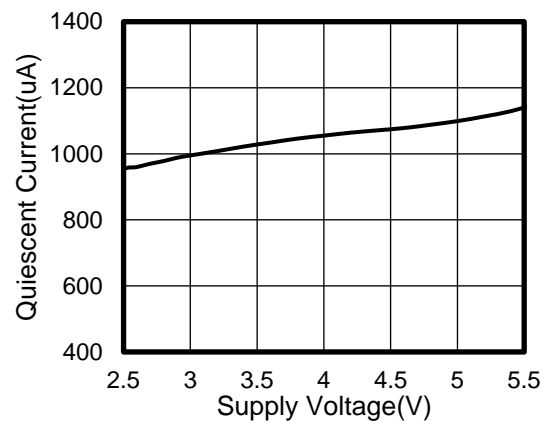

**Figure 10. Quiescent Current vs Supply Voltage**

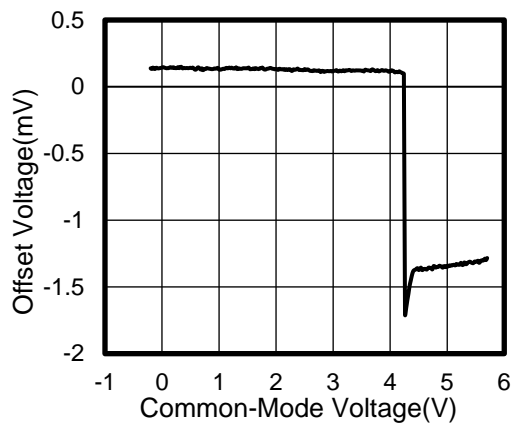

**Figure 11. Offset Voltage vs Common-Mode Voltage**

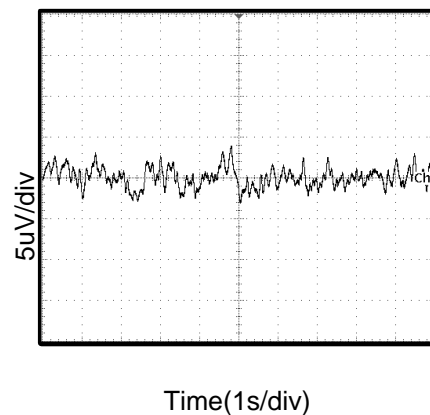

**Figure 12. 0.1Hz to 10Hz Input Voltage Noise**

## TYPICAL CHARACTERISTICS

At  $T_A = +25^\circ\text{C}$ ,  $V_S = 5\text{V}$ ,  $R_L = 10\text{k}\Omega$  connected to  $V_S/2$ ,  $V_{OUT} = V_S/2$ , unless otherwise noted.

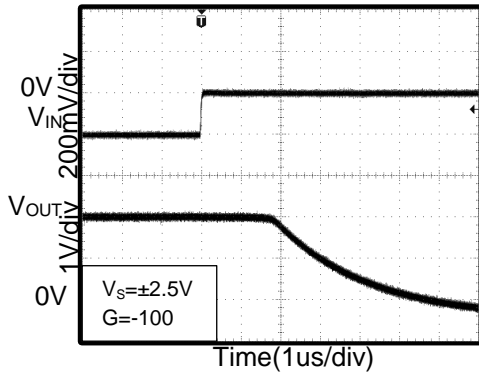

Figure 13. Positive Overvoltage Recovery

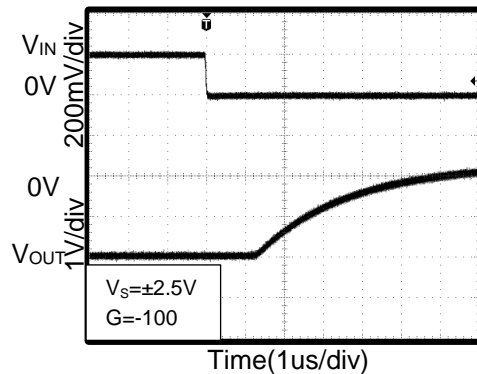

Figure 14. Negative Overvoltage Recovery

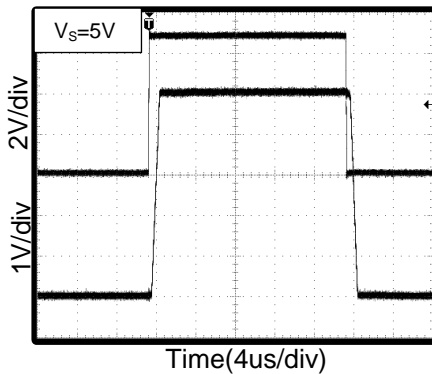

Figure 15. Large-Signal Step Response

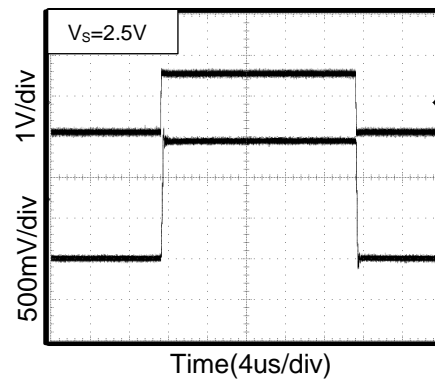

Figure 16. Large-Signal Step Response

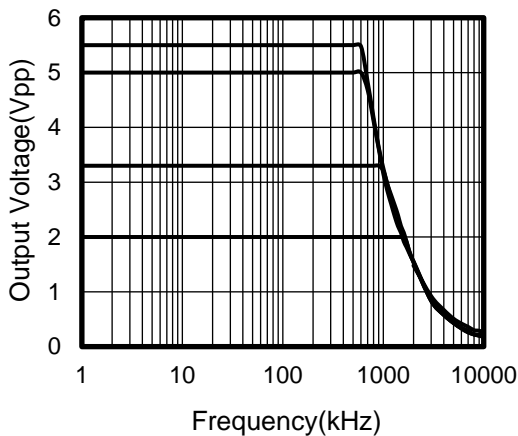

Figure 17. Closed-Loop Output Voltage Swing

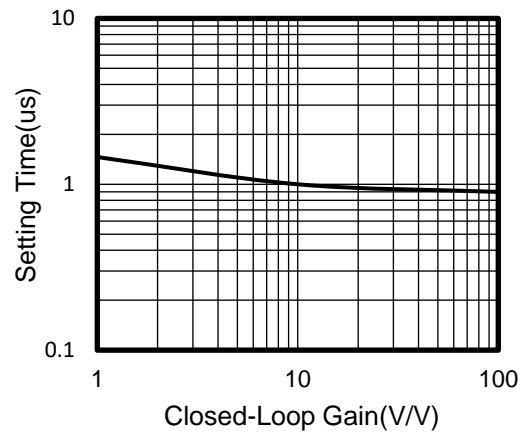

Figure 18. Setting Time vs Closed-Loop Gain

## TYPICAL CHARACTERISTICS

At  $T_A = +25^\circ\text{C}$ ,  $V_S = 5\text{V}$ ,  $R_L = 10\text{k}\Omega$  connected to  $V_S/2$ ,  $V_{OUT} = V_S/2$ , unless otherwise noted.

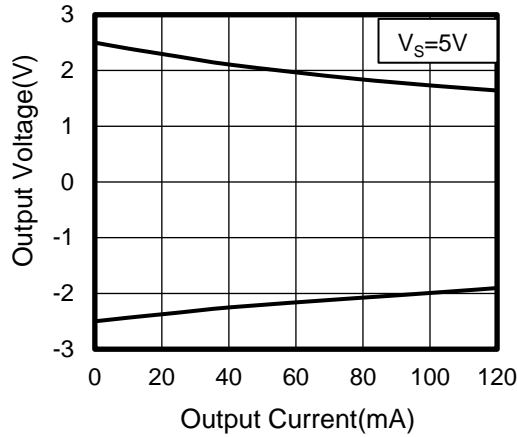

Figure 19. Output Voltage vs Output Current

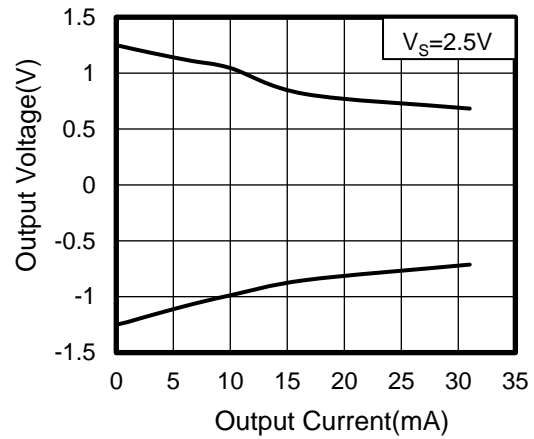

Figure 20. Output Voltage vs Output Current

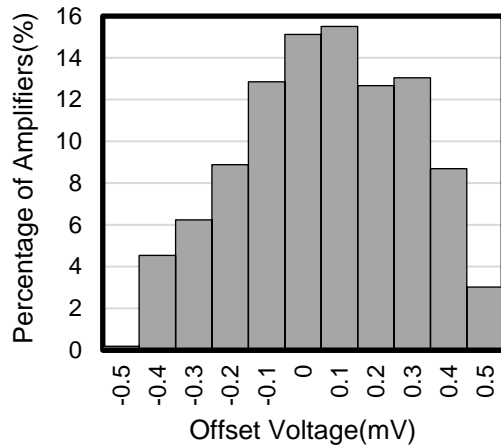

Figure 21. Offset Voltage Production Distribution

## Detailed Description

### Overview

The RS72XP devices are unity-gain stable, dual and quad-channel op amps with low noise and distortion. The device consists of a low noise input stage with a folded cascade and a rail-to-rail output stage. This topology exhibits superior noise and distortion performance across a wide range of supply voltages that are not delivered by legacy commodity audio operational amplifiers.

### Phase Reversal Protection

The RS72XP family has internal phase-reversal protection. Many op amps exhibit phase reversal when the input is driven beyond the linear common-mode range. This condition is most often encountered in noninverting circuits when the input is driven beyond the specified common-mode voltage range, causing the output to reverse into the opposite rail. The input of the RS72XP prevents phase reversal with excessive common-mode voltage. Instead, the appropriate rail limits the output voltage. This performance is shown in figure 22.

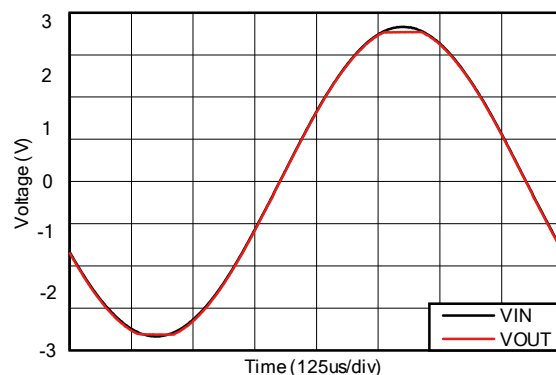

**Figure 22. Output Waveform Devoid of Phase Reversal During an Input Overdrive Condition**

### EMI Rejection Ratio (EMIRR)

The electromagnetic interference (EMI) rejection ratio, or EMIRR, describes the EMI immunity of operational amplifiers. An adverse effect that is common to many operational amplifiers is a change in the offset voltage as a result of RF signal rectification. An operational amplifier that is more efficient at rejecting this change in offset as a result of EMI has a higher EMIRR and is quantified by a decibel value. Measuring EMIRR can be performed in many ways, but this document provides the EMIRR IN+, which specifically describes the EMIRR performance when the RF signal is applied to the noninverting input pin of the operational amplifier. In general, only the noninverting input is tested for EMIRR for the following three reasons:

- Operational amplifier input pins are known to be the most sensitive to EMI, and typically rectify RF signals better than the supply or output pins.
- The noninverting and inverting operational amplifier inputs have symmetrical physical layouts and exhibit nearly matching EMIRR performance.
- EMIRR is easier to measure on noninverting pins than on other pins because the noninverting input pin can be isolated on a printed-circuit-board (PCB). This isolation allows the RF signal to be applied directly to the noninverting input pin with no complex interactions from other components or connecting PCB traces.

### Detailed Description (continued)

The EMIRR IN+ of the RS72XP is plotted versus frequency in Figure 23. If available, any dual and quad operational amplifier device versions have approximately identical EMIRR IN+ performance. The RS72XP unity-gain bandwidth is 10MHz. EMIRR performance below this frequency denotes interfering signals that fall within the operational amplifier bandwidth.

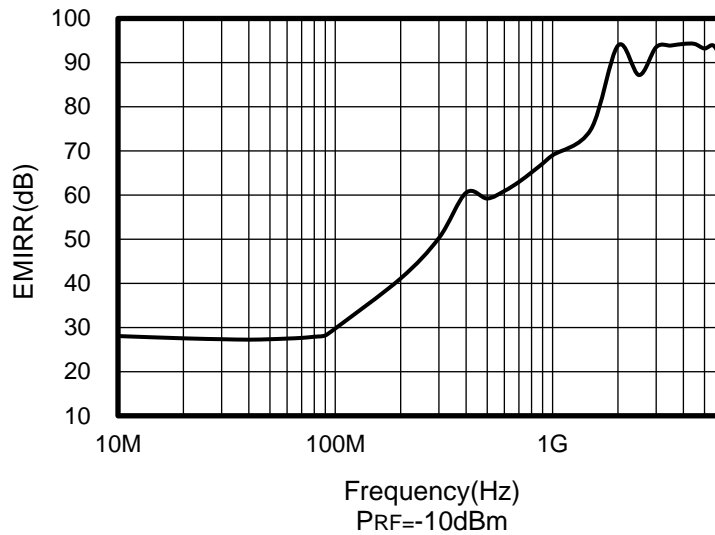

Figure 23. RS72XP EMIRR vs Frequency

### EMIRR IN+ Test Configuration

Figure 24 shows the circuit configuration for testing the EMIRR IN+. An RF source is connected to the operational amplifier noninverting input pin using a transmission line. The operational amplifier is configured in a unity-gain buffer topology with the output connected to a low-pass filter (LPF) and a digital multimeter (DMM). A large impedance mismatch at the operational amplifier input causes a voltage reflection; however, this effect is characterized and accounted for when determining the EMIRR IN+. The resulting dc offset voltage is sampled and measured by the multimeter. The LPF isolates the multimeter from residual RF signals that can interfere with multimeter accuracy.

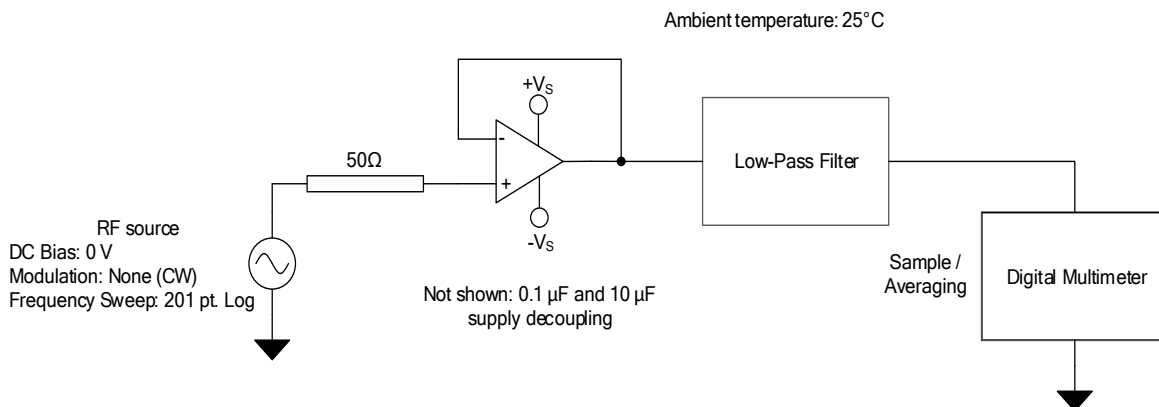

Figure 24. EMIRR IN+ Test Configuration Schematic

## APPLICATION NOTE

The RS721P, RS722P, RS724P are high precision, rail-to-rail operational amplifiers that can be run from a single-supply voltage 2.5V to 5.5V ( $\pm 1.25V$  to  $\pm 2.75V$ ). Supply voltages higher than 7V (absolute maximum) can permanently damage the amplifier. Rail-to-rail input and output swing significantly increases dynamic range, especially in low-supply applications. Good layout practice mandates use of a 0.1 $\mu$ F capacitor placed closely across the supply pins.

### Typical Applications

#### 25-kHz Low-pass Filter

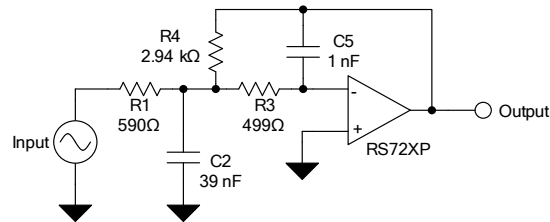

**Figure 25. 25-kHz Low-Pass Filter**

#### Design Requirements

Low-pass filters are commonly employed in signal processing applications to reduce noise and prevent aliasing. The RS72XP devices are ideally suited to construct high-speed, high-precision active filters. Figure 25 shows a second-order, low-pass filter commonly encountered in signal processing applications.

Use the following parameters for this design example:

- Gain = 5 V/V (inverting gain)
- Low-pass cutoff frequency = 25 kHz
- Second-order Chebyshev filter response with 3-dB gain peaking in the passband

#### Detailed Design Procedure

The infinite-gain multiple-feedback circuit for a low-pass network function is shown in Figure 25. Use Equation 1 to calculate the voltage transfer function.

$$\frac{\text{Output}}{\text{Input}}(s) = \frac{-1/R_1 R_3 C_2 C_5}{s^2 + (s/C_2) (1/R_1 + 1/R_3 + 1/R_4) + 1/R_3 R_4 C_2 C_5} \quad (1)$$

This circuit produces a signal inversion. For this circuit, the gain at dc and the low-pass cutoff frequency are calculated by Equation 2:

$$\text{Gain} = \frac{R_4}{R_1}$$

$$f_c = \frac{1}{2\pi} \sqrt{1/R_3 R_4 C_2 C_5}$$

(2)

#### Application Curve

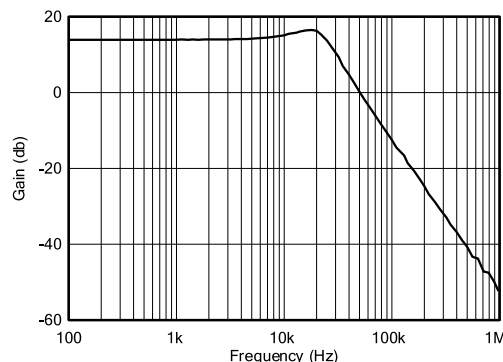

**Figure 26. Low-pass filter transfer function**

## LAYOUT

### Layout Guideline

Attention to good layout practices is always recommended. Keep traces short. When possible, use a PCB ground plane with surface-mount components placed as close to the device pins as possible. Place a 0.1 $\mu$ F capacitor closely across the supply pins.

These guidelines should be applied throughout the analog circuit to improve performance and provide benefits such as reducing the EMI susceptibility.

### Layout Example

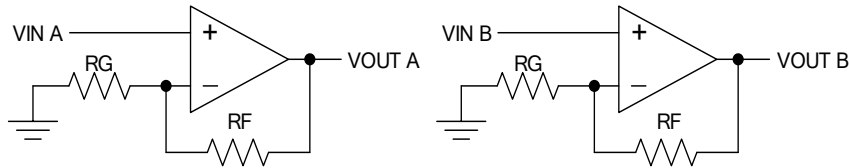

Figure 27. Schematic Representation

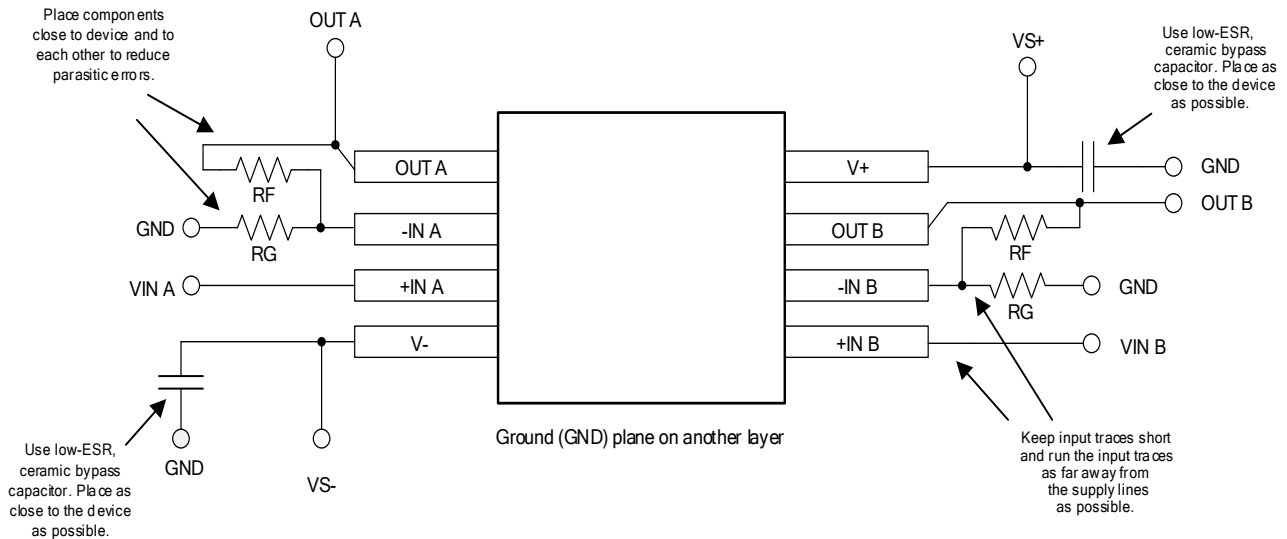
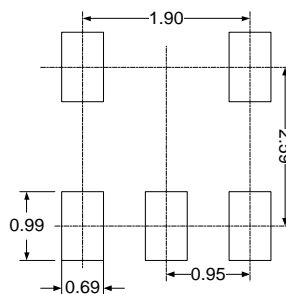
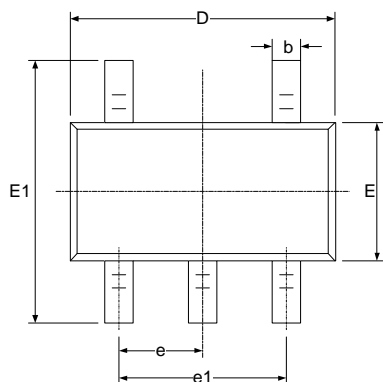
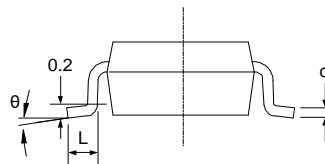
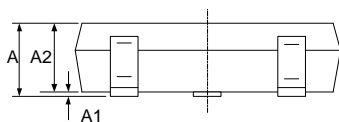
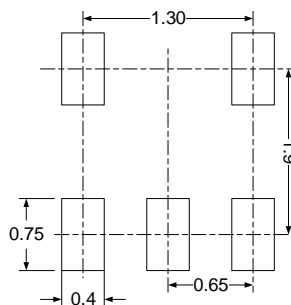
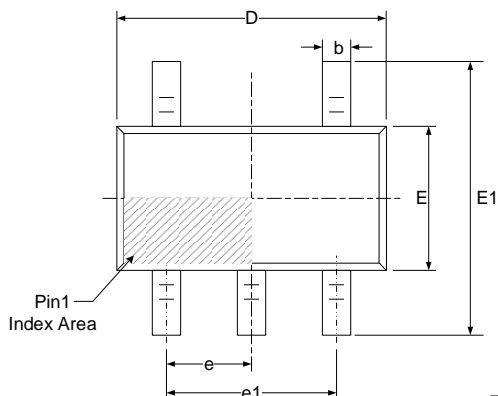
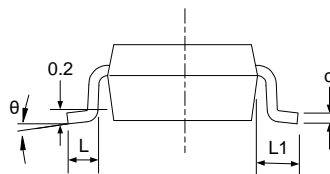
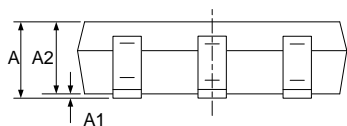

Figure 28. Layout Example



**PACKAGE OUTLINE DIMENSIONS**  
**SOT23-5**

**RECOMMENDED LAND PATTERN (Unit: mm)**

Symbol	Dimensions In Millimeters		Dimensions In Inches	
	Min	Max	Min	Max
A	1.050	1.250	0.041	0.049
A1	0.000	0.100	0.000	0.004
A2	1.050	1.150	0.041	0.045
b	0.300	0.500	0.012	0.020
c	0.100	0.200	0.004	0.008
D	2.820	3.020	0.111	0.119
E	1.500	1.700	0.059	0.067
E1	2.650	2.950	0.104	0.116
e	0.950(BSC)		0.037(BSC)	
e1	1.800	2.000	0.071	0.079
L	0.300	0.600	0.012	0.024
$\theta$	0°	8°	0°	8°

**SOT353(SC70-5)**

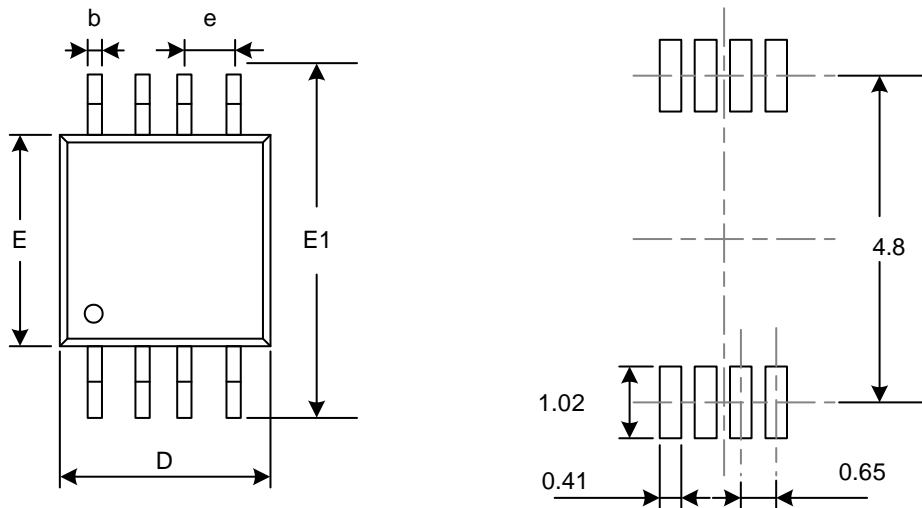
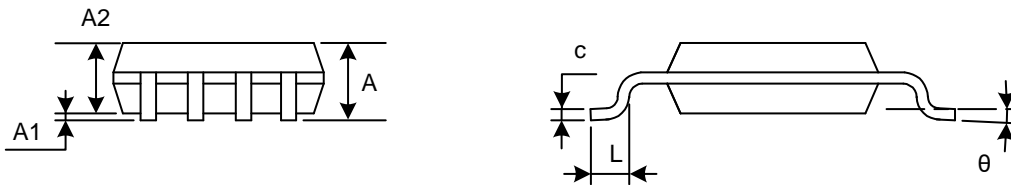
**RECOMMENDED LAND PATTERN (Unit: mm)**

Symbol	Dimensions In Millimeters		Dimensions In Inches	
	Min	Max	Min	Max
A	0.900	1.100	0.035	0.043
A1	0.000	0.100	0.000	0.004
A2	0.900	1.000	0.035	0.039
b	0.150	0.350	0.006	0.014
c	0.080	0.150	0.003	0.006
D	2.000	2.200	0.079	0.087
E	1.150	1.350	0.045	0.053
E1	2.150	2.450	0.085	0.096
e	0.650(BSC)		0.026(BSC)	
e1	1.300(BSC)		0.051(BSC)	
L	0.260	0.460	0.010	0.018
L1	0.525		0.021	
θ	0°	8°	0°	8°

**MSOP-8**

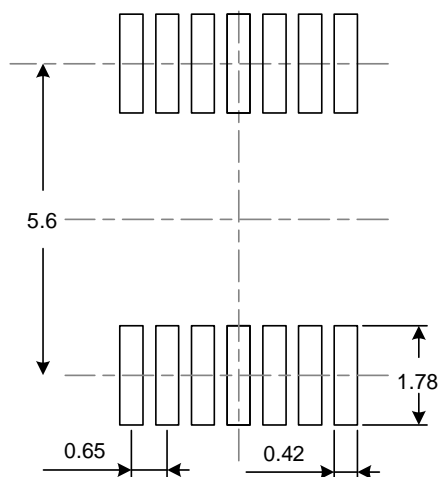
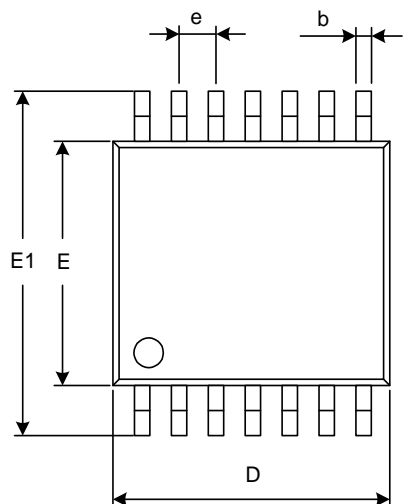
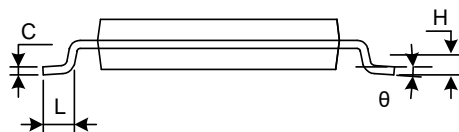
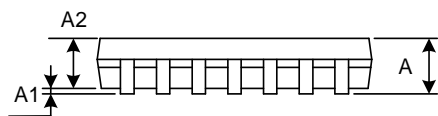
**RECOMMENDED LAND PATTERN (Unit: mm)**

Symbol	Dimensions In Millimeters		Dimensions In Inches	
	Min	Max	Min	Max
A	0.820	1.100	0.032	0.043
A1	0.020	0.150	0.001	0.006
A2	0.750	0.950	0.030	0.037
b	0.250	0.380	0.010	0.015
c	0.090	0.230	0.004	0.009
D	2.900	3.100	0.114	0.122
e	0.650(BSC)		0.026(BSC)	
E	2.900	3.100	0.114	0.122
E1	4.750	5.050	0.187	0.199
L	0.400	0.800	0.016	0.031
θ	0°	6°	0°	6°

**TSSOP-14**

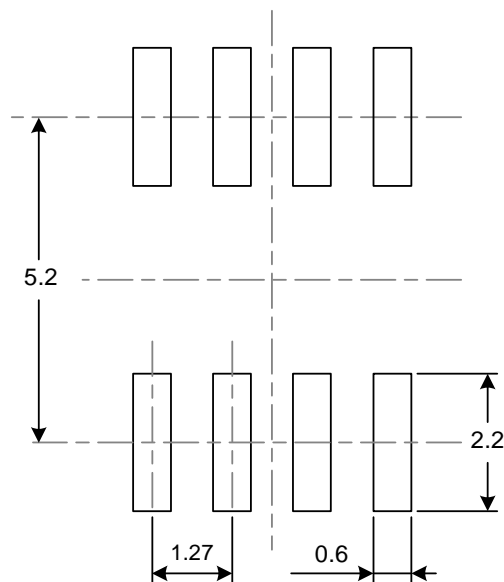
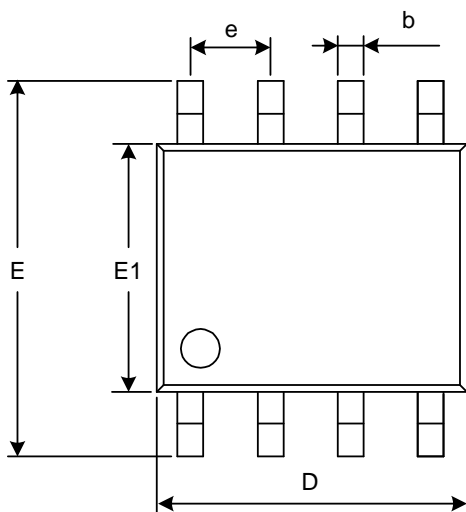
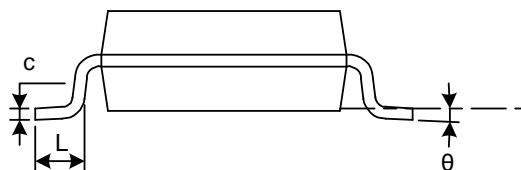
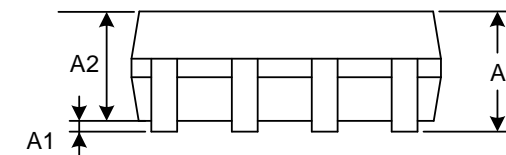
**RECOMMENDED LAND PATTERN (Unit: mm)**

Symbol	Dimensions In Millimeters		Dimensions In Inches	
	Min	Max	Min	Max
A		1.200		0.047
A1	0.050	0.150	0.002	0.006
A2	0.800	1.050	0.031	0.041
b	0.190	0.300	0.007	0.012
c	0.090	0.200	0.004	0.008
D	4.860	5.100	0.191	0.201
E	4.300	4.500	0.169	0.177
E1	6.250	6.550	0.246	0.258
e	0.650(BSC)		0.026(BSC)	
L	0.500	0.700	0.020	0.028
H	0.25(TYP)		0.01(TYP)	
$\theta$	1°	7°	1°	7°

**SOIC-8(SOP8)**

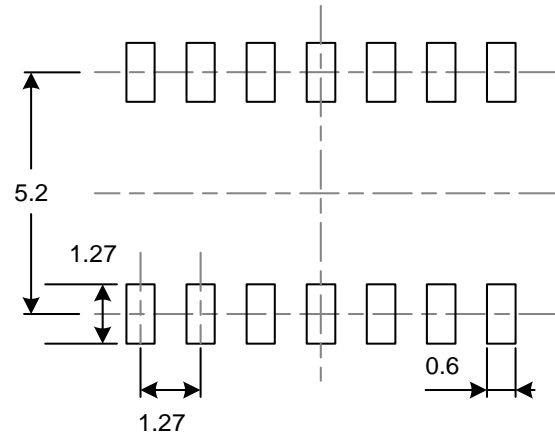
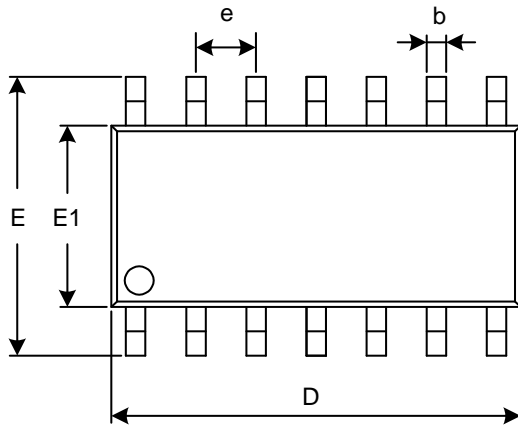
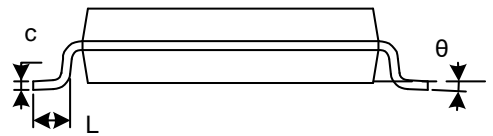
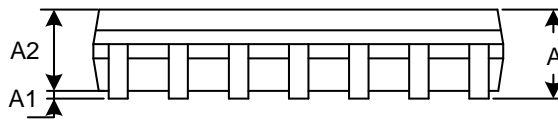
**RECOMMENDED LAND PATTERN (Unit: mm)**

Symbol	Dimensions In Millimeters		Dimensions In Inches	
	Min	Max	Min	Max
A	1.350	1.750	0.053	0.069
A1	0.100	0.250	0.004	0.010
A2	1.350	1.550	0.053	0.061
b	0.330	0.510	0.013	0.020
c	0.170	0.250	0.007	0.010
D	4.800	5.000	0.189	0.197
e	1.270(BSC)		0.050(BSC)	
E	5.800	6.200	0.228	0.244
E1	3.800	4.000	0.150	0.157
L	0.400	1.270	0.016	0.050
$\theta$	0°	8°	0°	8°

**SOIC-14(SOP14)**

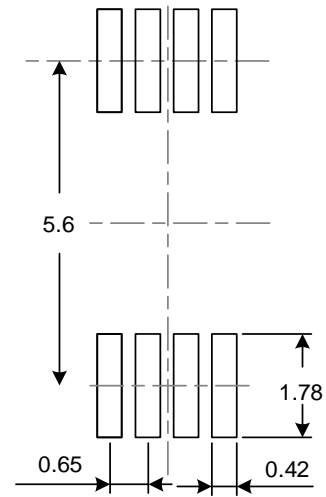
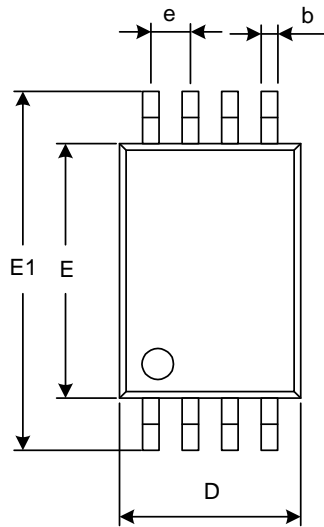
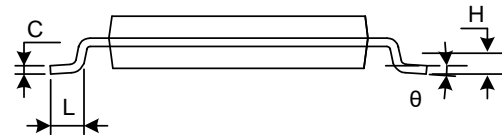
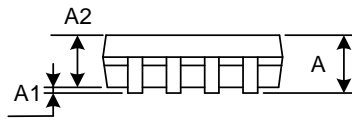
**RECOMMENDED LAND PATTERN (Unit: mm)**

Symbol	Dimensions In Millimeters		Dimensions In Inches	
	Min	Max	Min	Max
A	1.350	1.750	0.053	0.069
A1	0.100	0.250	0.004	0.010
A2	1.350	1.550	0.053	0.061
b	0.310	0.510	0.012	0.020
c	0.100	0.250	0.004	0.010
D	8.450	8.850	0.333	0.348
e	1.270(BSC)		0.050(BSC)	
E	5.800	6.200	0.228	0.244
E1	3.800	4.000	0.150	0.157
L	0.400	1.270	0.016	0.050
$\theta$	0°	8°	0°	8°

**TSSOP-8**

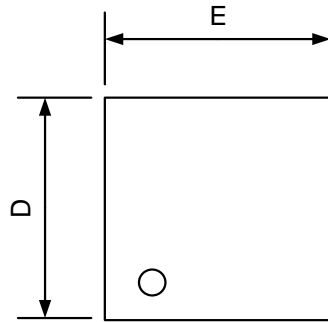
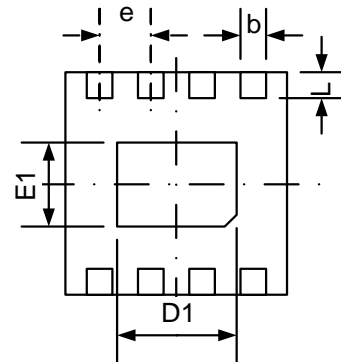
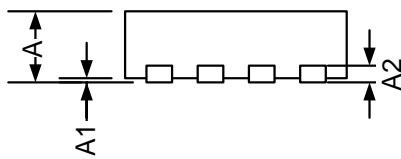
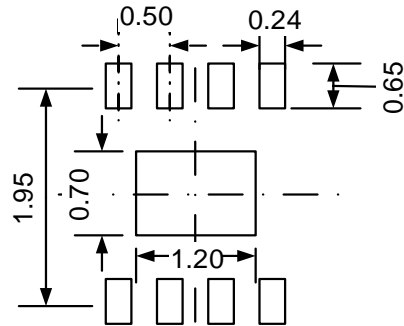
**RECOMMENDED LAND PATTERN (Unit: mm)**

Symbol	Dimensions In Millimeters		Dimensions In Inches	
	Min	Max	Min	Max
A		1.200		0.047
A1	0.050	0.150	0.002	0.006
A2	0.800	1.050	0.031	0.041
b	0.190	0.300	0.007	0.012
c	0.090	0.200	0.004	0.008
D	2.900	3.100	0.114	0.122
E	4.300	4.500	0.169	0.177
E1	6.250	6.550	0.246	0.258
e	0.650(BSC)		0.026(BSC)	
L	0.500	0.700	0.020	0.028
H	0.25(TYP)		0.01(TYP)	
$\theta$	1°	7°	1°	7°

**TDFN2x2-8L**

**TOP VIEW**

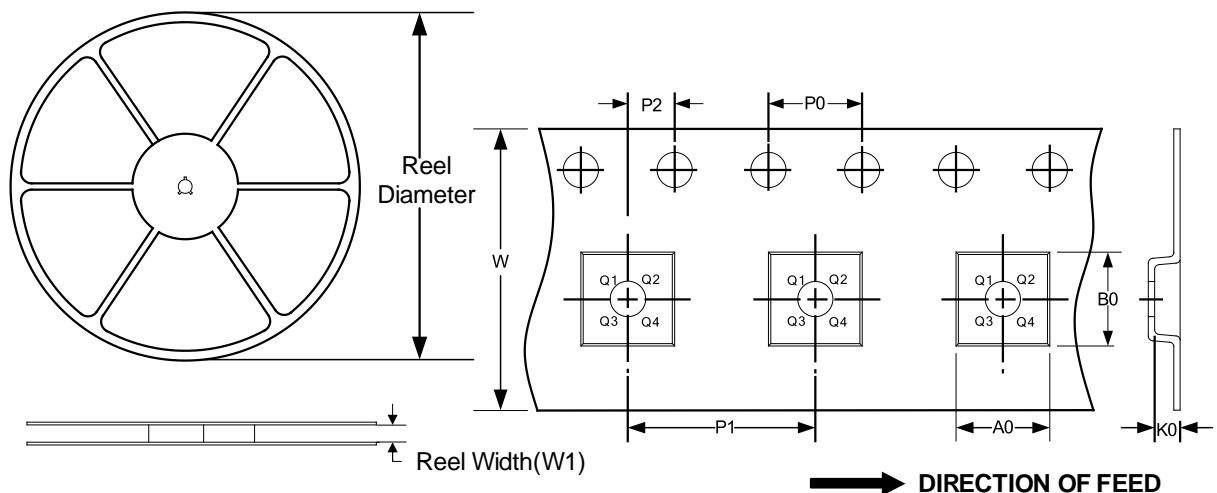
**BOTTOM VIEW**

**SIDE VIEW**

**RECOMMENDED LAND PATTERN (Unit: mm)**

Symbol	Dimensions In Millimeters		Dimensions In Inches	
	Min	Max	Min	Max
A	0.700	0.800	0.028	0.031
A1	0.000	0.050	0.000	0.002
A2	0.203(TYP)		0.008(TYP)	
b	0.180	0.300	0.007	0.012
D	1.900	2.100	0.075	0.083
D1	1.100	1.300	0.043	0.051
E	1.900	2.100	0.075	0.083
E1	0.600	0.800	0.024	0.031
e	0.500(TYP)		0.020(TYP)	
L	0.250	0.450	0.010	0.018



**TAPE AND REEL INFORMATION**  
**REEL DIMENSIONS**
**TAPE DIMENSION**

NOTE: The picture is only for reference. Please make the object as the standard.

**KEY PARAMETER LIST OF TAPE AND REEL**

Package Type	Reel Diameter	Reel Width(mm)	A0 (mm)	B0 (mm)	K0 (mm)	P0 (mm)	P1 (mm)	P2 (mm)	W (mm)	Pin1 Quadrant
SOT23-5	7"	9.5	3.20	3.20	1.40	4.0	4.0	2.0	8.0	Q3
SOIC-8(SOP8)	13"	12.4	6.40	5.40	2.10	4.0	8.0	2.0	12.0	Q1
MSOP-8	13"	12.4	5.20	3.30	1.50	4.0	8.0	2.0	12.0	Q1
SOIC-14(SOP14)	13"	16.4	6.60	9.30	2.10	4.0	8.0	2.0	16.0	Q1
TSSOP-8	13"	12.4	6.90	3.45	1.65	4.0	8.0	2.0	12.0	Q1
TSSOP-14	13"	12.4	6.95	5.60	1.20	4.0	8.0	2.0	12.0	Q1
SOT353(SC70-5)	7"	9.5	2.25	2.55	1.20	4.0	4.0	2.0	8.0	Q3
TDFN2X2-8L	7"	9.5	2.30	2.30	1.10	4.0	4.0	2.0	8.0	Q2

单击下面可查看定价，库存，交付和生命周期等信息

[>>Runic\(润石\)](#)