

# RS6G14 6-channel Schmitt-Trigger Inverter

## FEATURES

- Operating Voltage Range: 1.65V to 5.5V
- Low Power Consumption: 1µA (Max)
- Operating Temperature Range: -40°C to +125°C
- Input Accept Voltage to 5.5V
- High Output Drive: ±24mA at V<sub>CC</sub>=3.0V
- I<sub>off</sub> Supports Partial-Power-Down Mode Operation
- PACKAGES: SOIC-14(SOP14)、TSSOP-14

## APPLICATIONS

- AC Receiver and
- Home Theaters
- Blu-ray Players and Home Theaters
- Desktops or Notebook PCs
- Digital Video Cameras (DVC)
- Mobile Phones
- Personal Navigation Device (GPS)
- Portable Media Player

### Functional Block Diagram

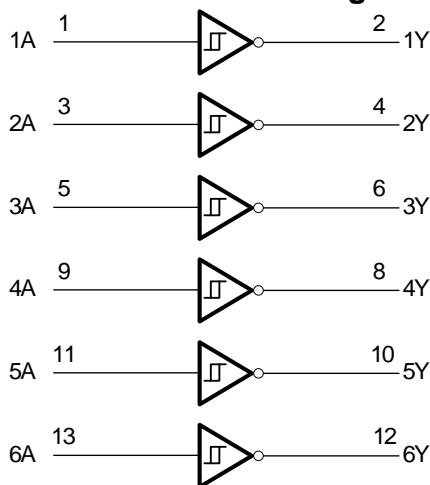

## DESCRIPTION

The RS6G14 6-channel Schmitt-trigger inverter is designed for 1.65V to 5.5V V<sub>CC</sub> operation.

The RS6G14 device contains six inverters and performs the Boolean function  $Y = \bar{A}$ . The device functions as six independent inverters with Schmitt-trigger inputs, so the device has different input threshold levels for positive-going (V<sub>T+</sub>) and negative going (V<sub>T-</sub>) signals to provide hysteresis (ΔV<sub>T</sub>) which makes the device tolerant to slow or noisy input signals.

This device is fully specified for partial-power-down applications using I<sub>off</sub>. The I<sub>off</sub> circuitry disables the outputs, preventing damaging current backflow through the device when it is powered down.

The RS6G14 is available in Green SOIC-14(SOP14) and TSSOP-14 packages. It operates over an ambient temperature range of -40°C to +125°C.

### Device Information (1)

PART NUMBER	PACKAGE	BODY SIZE (NOM)
RS6G14	SOIC-14(SOP14)	8.65mm×3.90mm
	TSSOP-14	5.00mm×4.40mm

(1) For all available packages, see the orderable addendum at the end of the data sheet.

### FUNCTION TABLE

INPUT	OUTPUT
A	Y
H	L
L	H

Y =  $\bar{A}$   
H=High Voltage Level  
L=Low Voltage Level

## Revision History

Note: Page numbers for previous revisions may differ from page numbers in the current version.

Version	Change Date	Change Item
A.1	2021/01/20	Initial version completed
A.2	2021/11/26	Added the TAPE AND REEL INFORMATION

## PIN CONFIGURATIONS

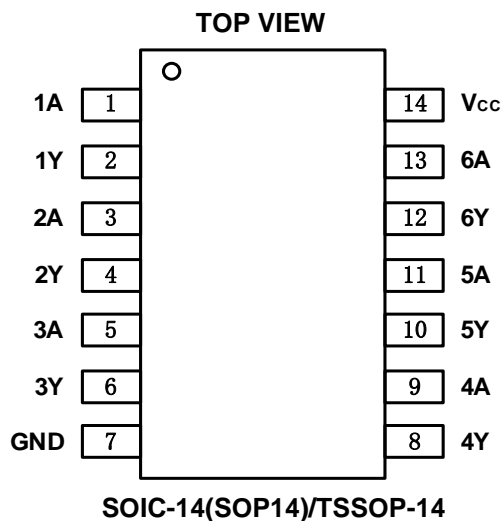

## PIN DESCRIPTION

NAME	PIN	I/O	DESCRIPTION
	SOIC-14(SOP14)/TSSOP-14		
1A	1	I	Input 1
1Y	2	O	output 1
2A	3	I	Input 2
2Y	4	O	output 2
3A	5	I	Input 3
3Y	6	O	output 3
GND	7	P	Ground
4Y	8	O	output 4
4A	9	I	Input 4
5Y	10	O	output 5
5A	11	I	Input 5
6Y	12	O	output 6
6A	13	I	Input 6
Vcc	14	P	Power pin

## SPECIFICATIONS

### Absolute Maximum Ratings <sup>(1)</sup>

over operating free-air temperature range (unless otherwise noted) <sup>(1)</sup> <sup>(2)</sup>

		MIN	MAX	UNIT
V <sub>CC</sub>	Supply voltage range	-0.5	6.5	V
V <sub>I</sub>	Input voltage range <sup>(2)</sup>	-0.5	6.5	V
V <sub>O</sub>	Voltage range applied to any output in the high-impedance or power-off state <sup>(2)</sup>	-0.5	6.5	V
V <sub>O</sub>	Voltage range applied to any output in the high or low state <sup>(2)</sup> <sup>(3)</sup>	-0.5	V <sub>CC</sub> +0.5	V
I <sub>IK</sub>	Input clamp current	V <sub>I</sub> <0	-50	mA
I <sub>OK</sub>	Output clamp current	V <sub>O</sub> <0	-50	mA
I <sub>O</sub>	Continuous output current		±50	mA
Continuous current through V <sub>CC</sub> or GND			±100	mA
T <sub>J</sub>	Junction temperature		150	°C
T <sub>stg</sub>	Storage temperature	-65	150	°C

(1) Stresses beyond those listed under *Absolute Maximum Ratings* may cause permanent damage to the device. These are stress ratings only, and functional operation of the device at these or any other conditions beyond those indicated under *Recommended Operating Conditions* is not implied. Exposure to absolute-maximum-rated conditions for extended periods may affect device reliability.

(2) The input and output negative-voltage ratings may be exceeded if the input and output current ratings are observed.

(3) The value of V<sub>CC</sub> is provided in the *Recommended Operating Conditions table*.

### ESD Ratings

		VALUE	UNIT	
V <sub>(ESD)</sub>	Electrostatic discharge	Human-body model (HBM)	±8000	V
		Machine model (MM)	±500	V

### Thermal Information:

THERMAL METRIC		RS6G14		UNIT
		14PINS		
		SOIC-14(SOP14)	TSSOP-14	
R <sub>θJA</sub>	Junction-to-ambient thermal resistance	122.2	141.2	°C/W
R <sub>θJC(top)</sub>	Junction-to-case(top) thermal resistance	80.9	78.8	°C/W
R <sub>θJB</sub>	Junction-to-board thermal resistance	80.6	85.8	°C/W
Ψ <sub>JT</sub>	Junction-to-top characterization parameter	40.4	27.7	°C/W
Ψ <sub>JB</sub>	Junction-to-board characterization parameter	80.3	85.5	°C/W
R <sub>θJC(bot)</sub>	Junction-to-case(bottom) thermal resistance	N/A	N/A	°C/W

**PACKAGE/ORDERING INFORMATION**

PRODUCT	ORDERING NUMBER	TEMPERATURE RANGE	PACKAGE LEAD	PACKAGE MARKING <sup>(1)</sup>	PACKAGE OPTION
RS6G14	RS6G14XP	-40°C ~+125°C	SOIC-14(SOP14)	RS6G14	Tape and Reel,4000
	RS6G14XQ	-40°C ~+125°C	TSSOP-14	RS6G14	Tape and Reel,4000

NOTE:

- (1) There may be additional marking, which relates to the lot trace code information (data code and vendor code), the logo or the environmental category on the device.

## ELECTRICAL CHARACTERISTICS

Over recommended operating free-air temperature range (Full=-40°C to +125°C, typical values are at  $T_A = +25^\circ\text{C}$ , unless otherwise noted.) <sup>(1)</sup>

### Recommended Operating Conditions

PARAMETER	SYMBOL	TEST CONDITIONS	MIN	MAX	UNIT
Supply voltage	$V_{CC}$	Operating	1.65	5.5	V
		Data retention only	1.5		
Input voltage	$V_I$		0	5.5	V
Output voltage	$V_O$		0	$V_{CC}$	V
Operating temperature	$T_A$		-40	+125	°C

### DC Characteristics

PARAMETER		TEST CONDITIONS	$V_{CC}$	TEMP	MIN	TYP	MAX	UNIT
$V_{T+}$	Positive going input threshold voltage		1.65V	Full	0.75		1.05	V
			2.3V		1.25		1.55	
			3V		1.5		2.1	
			4.5V		2.3		3.0	
			5.5V		2.8		3.4	
$V_{T-}$	Negative going input threshold voltage		1.65V	Full	0.3		0.6	V
			2.3V		0.35		0.65	
			3V		0.45		0.75	
			4.5V		0.7		1.0	
			5.5V		0.85		1.15	
$\Delta V_T$	Hysteresis ( $V_{T+}-V_{T-}$ )		1.65V	Full	0.35		0.6	V
			2.3V		0.6		1.2	
			3V		1.05		1.65	
			4.5V		1.6		2.0	
			5.5V		1.95		2.25	
$V_{OH}$		$I_{OH} = -100\mu\text{A}$	1.65V to 5.5V	Full	$V_{CC}-0.1$			V
		$I_{OH} = -4\text{mA}$	1.65V		1.2			
		$I_{OH} = -8\text{mA}$	2.3V		1.9			
		$I_{OH} = -16\text{mA}$	3V		2.4			
		$I_{OH} = -24\text{mA}$			2.3			
		$I_{OH} = -32\text{mA}$	4.5V		3.8			
$V_{OL}$		$I_{OL} = 100\mu\text{A}$	1.65V to 5.5V	Full			0.1	V
		$I_{OL} = 4\text{mA}$	1.65V				0.45	
		$I_{OL} = 8\text{mA}$	2.3V				0.3	
		$I_{OL} = 16\text{mA}$	3V				0.4	
		$I_{OL} = 24\text{mA}$					0.55	
		$I_{OL} = 32\text{mA}$	4.5V				0.55	
$I_i$	A input	$V_I=5.5\text{V}$ or GND	0V to 5.5V	+25°C	$\pm 0.1$	$\pm 1$	$\mu\text{A}$	
				Full		$\pm 5$		
$I_{off}$		$V_I$ or $V_O=5.5\text{V}$	0	+25°C	$\pm 0.1$	$\pm 1$	$\mu\text{A}$	
				Full		$\pm 10$		
$I_{CC}$		$V_I=5.5\text{V}$ or GND, $I_O=0$	1.65V to 5.5V	+25°C	0.1	1	$\mu\text{A}$	

			Full			10	
$\Delta I_{CC}$	One input at $V_{CC}-0.6V$ , Other inputs at $V_{CC}$ or GND	3V to 5.5V	Full			500	$\mu A$

**AC Characteristics**

PARAMETER	SYMBOL	TEST CONDITIONS		TEMP	MIN	TYP	MAX	UNIT
Propagation Delay	$t_{pd}$	$V_{CC}=1.8V\pm 0.15V$	$C_L=30pF, R_L=500\Omega$	Full		7.5		ns
		$V_{CC}=2.5V\pm 0.2V$	$C_L=30pF, R_L=500\Omega$	Full		3.6		
		$V_{CC}=3.3V\pm 0.3V$	$C_L=50pF, R_L=500\Omega$	Full		3.1		
		$V_{CC}=5V\pm 0.5V$	$C_L=50pF, R_L=500\Omega$	Full		2.7		
Input Capacitance	$C_i$	$V_{CC}=3.3V$	$V_I=V_{CC}$ or GND	+25°C		4		pF
Power dissipation capacitance	$C_{pd}$	$V_{CC}=1.8V$	f=10MHz	+25°C		20		pF
		$V_{CC}=2.5V$				21		
		$V_{CC}=3.3V$				22		
		$V_{CC}=5V$				25		

(1) All unused inputs of the device must be held at  $V_{CC}$  or GND to ensure proper device operation.

## Parameter Measurement Information

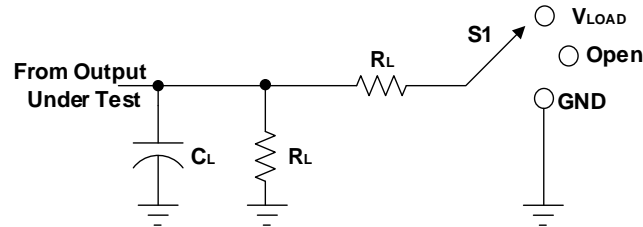

TEST	S1
$t_{PLH}/t_{PHL}$	Open
$t_{PZL}/t_{PZH}$	$V_{LOAD}$
$t_{PHZ}/t_{PZH}$	GND

$V_{CC}$	INPUTS		$V_M$	$V_{LOAD}$	$C_L$	$R_L$	$V_{\Delta}$
	$V_I$	$t_r/t_f$					
$1.8V \pm 0.15V$	$V_{CC}$	$\leq 2ns$	$V_{CC}/2$	$2 \times V_{CC}$	30pF	1k $\Omega$	0.15V
$2.5V \pm 0.2V$	$V_{CC}$	$\leq 2ns$	$V_{CC}/2$	$2 \times V_{CC}$	30pF	500 $\Omega$	0.15V
$3.3V \pm 0.3V$	3V	$\leq 2.5ns$	1.5V	6V	50pF	500 $\Omega$	0.3V
$5V \pm 0.5V$	$V_{CC}$	$\leq 2.5ns$	$V_{CC}/2$	$2 \times V_{CC}$	50pF	500 $\Omega$	0.3V

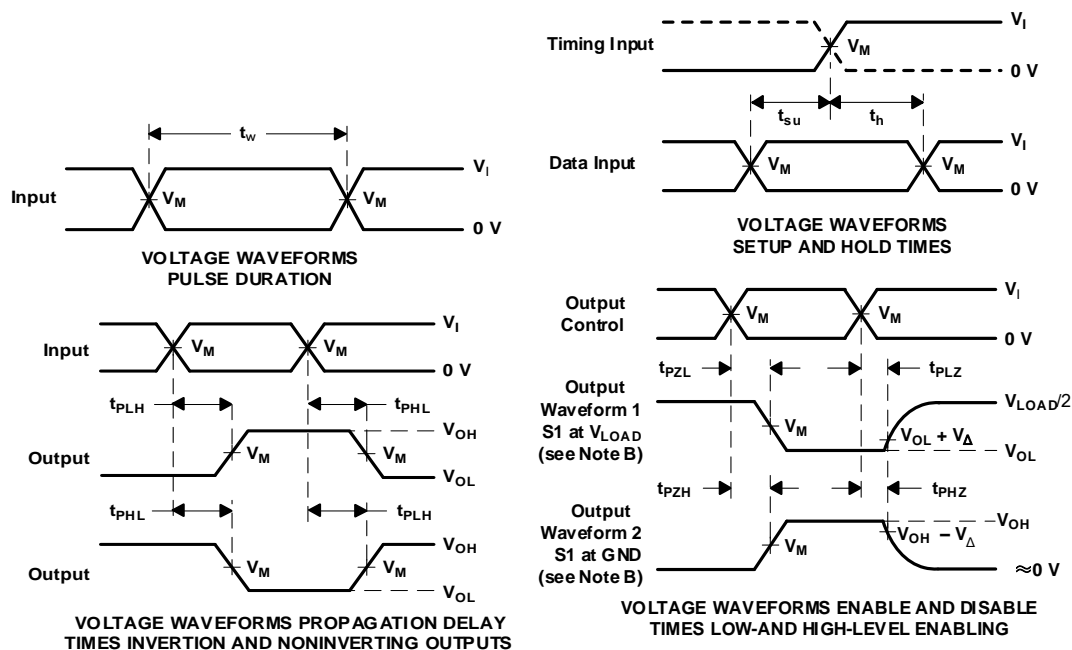

NOTES: A.  $C_L$  includes probe and jig capacitance.

B. Waveform 1 is for an output with internal conditions such that the output is low, except when disabled by the output control. Waveform 2 is for an output with internal conditions such that the output is high, except when disabled by the output control.

C. All input pulses are supplied by generators having the following characteristics:  $PRR \leq 10 \text{ MHz}$ ,  $Z_o = 50 \Omega$ .

D. The outputs are measured one at a time, with one transition per measurement.

E.  $t_{PLZ}$  and  $t_{PHZ}$  are the same as  $t_{dis}$ .

F.  $t_{PZL}$  and  $t_{PZH}$  are the same as  $t_{en}$ .

G.  $t_{PLH}$  and  $t_{PHL}$  are the same as  $t_{pd}$ .

H. All parameters and waveforms are not applicable to all devices.

**Figure 1. Load Circuit and Voltage Waveforms**



# PACKAGE OUTLINE DIMENSIONS

## SOIC-14(SOP14)

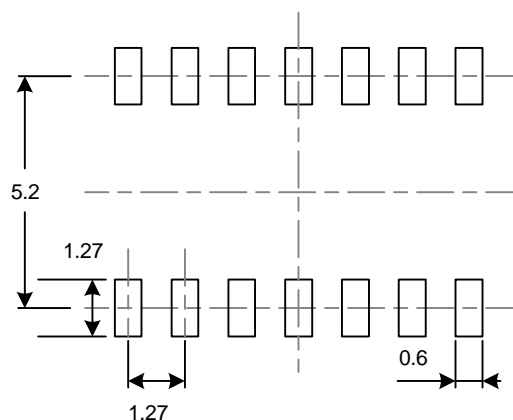
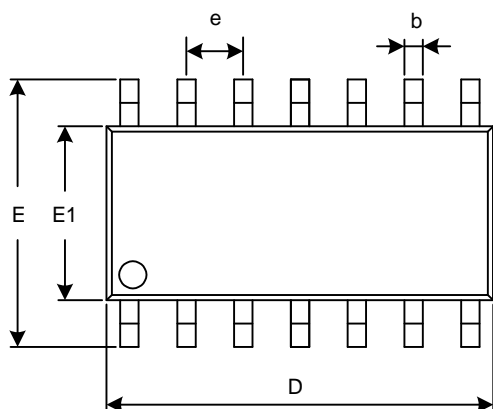

RECOMMENDED LAND PATTERN (Unit: mm)

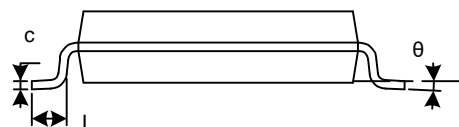
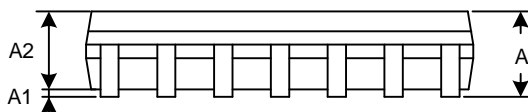

Symbol	Dimensions In Millimeters		Dimensions In Inches	
	Min	Max	Min	Max
A	1.350	1.750	0.053	0.069
A1	0.100	0.250	0.004	0.010
A2	1.350	1.550	0.053	0.061
b	0.310	0.510	0.012	0.020
c	0.100	0.250	0.004	0.010
D	8.450	8.850	0.333	0.348
e	1.270(BSC)		0.050(BSC)	
E	5.800	6.200	0.228	0.244
E1	3.800	4.000	0.150	0.157
L	0.400	1.270	0.016	0.050
$\theta$	0°	8°	0°	8°

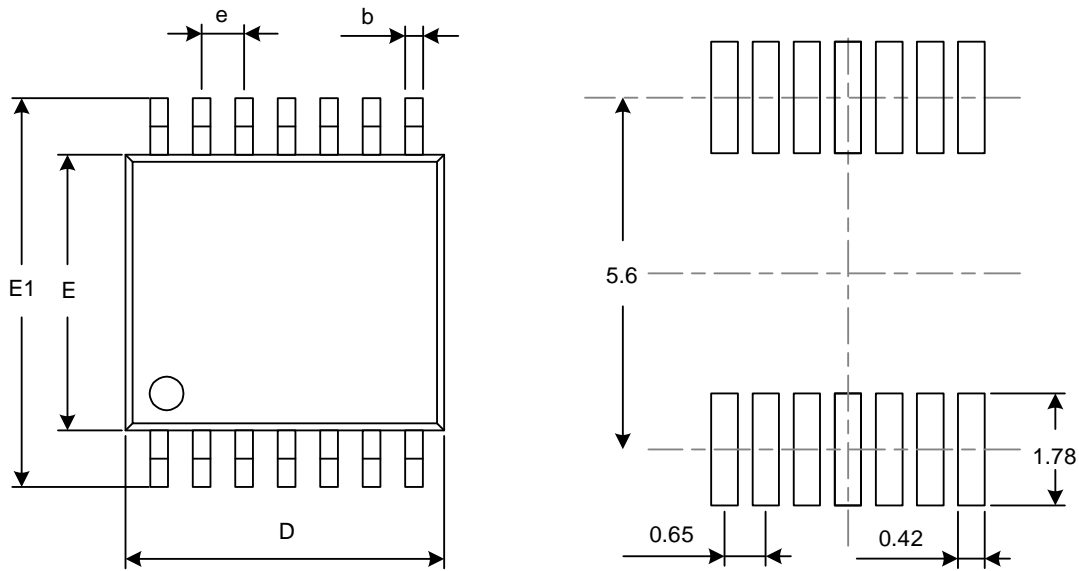
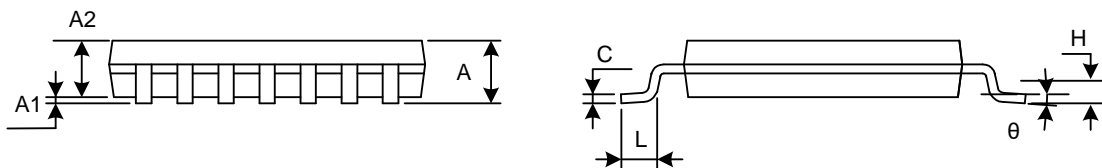
**TSSOP-14**

**RECOMMENDED LAND PATTERN (Unit: mm)**

Symbol	Dimensions In Millimeters		Dimensions In Inches	
	Min	Max	Min	Max
A		1.200		0.047
A1	0.050	0.150	0.002	0.006
A2	0.800	1.050	0.031	0.041
b	0.190	0.300	0.007	0.012
c	0.090	0.200	0.004	0.008
D	4.860	5.100	0.191	0.201
E	4.300	4.500	0.169	0.177
E1	6.250	6.550	0.246	0.258
e	0.650 (BSC)		0.026 (BSC)	
L	0.500	0.700	0.020	0.028
H	0.25 (TYP)		0.01 (TYP)	
θ	1°	7°	1°	7°

## TAPE AND REEL INFORMATION

### REEL DIMENSIONS

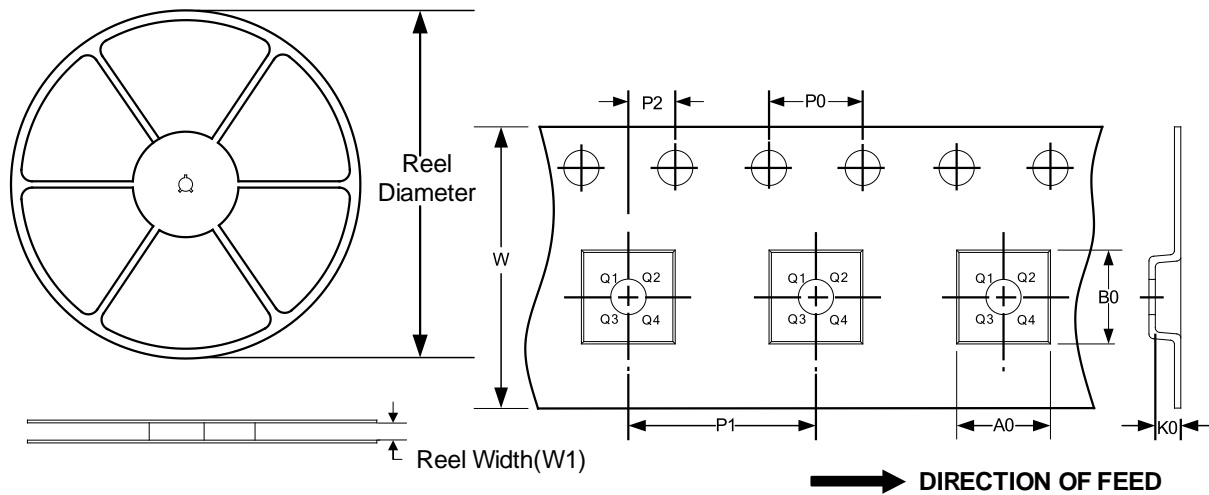
### TAPE DIMENSION



NOTE: The picture is only for reference. Please make the object as the standard.

### KEY PARAMETER LIST OF TAPE AND REEL

Package Type	Reel Diameter	Reel Width(mm)	A0 (mm)	B0 (mm)	K0 (mm)	P0 (mm)	P1 (mm)	P2 (mm)	W (mm)	Pin1 Quadrant
SOIC-14(SOP14)	13"	16.4	6.60	9.30	2.10	4.0	8.0	2.0	16.0	Q1
TSSOP-14	13"	12.4	6.95	5.60	1.20	4.0	8.0	2.0	12.0	Q1

单击下面可查看定价，库存，交付和生命周期等信息

[>>Runic\(润石\)](#)