

RS1G125 Single Bus Buffer Gate With 3-State Output

FEATURES

- Operating Voltage Range: 1.65V to 5.5V
- Low Power Consumption: 1µA (Max)
- Operating Temperature Range: -40°C to +125°C
- Inputs Accept Voltage to 5.5V
- ±24mA Output Drive at V_{CC}=3.0V
- Latch-up Performance Exceeds 100mA
- Micro SIZE PACKAGES: SOT23-5, SC70-5

APPLICATIONS

- AV Receiver
- Cable Modem Termination Systems
- Digital Picture Frame (DPF)
- High-Speed Data Acquisition and Generation
- Motor Controls: High-Voltage
- Personal Navigation Device (GPS)
- Portable Media Player
- Video Communication Systems

Simplified Schematic

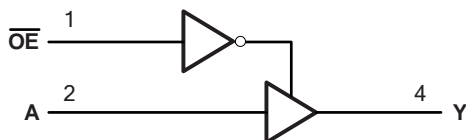

DESCRIPTION

The single buffer is designed for 1.65V to 5.5V V_{CC} operation. The RS1G125 device is single line driver with 3-state output. The output is disabled when the output-enable (\overline{OE}) input is high.

This device is fully specified for partial-power-down applications using I_{off}. The I_{off} circuitry disables the outputs, preventing damaging current backflow through the device when it is powered down.

To ensure the high-impedance state during power up or power down, \overline{OE} should be tied to V_{CC} through a pullup resistor, the minimum value of the resistor is determined by the current-sinking capability of the driver.

The RS1G125 is available in Green SOT23-5 and SC70-5 packages. It operates over an ambient temperature range of -40°C to +125°C.

Device Information (1)

| PART NUMBER | PACKAGE | BODY SIZE (NOM) |
|-------------|------------|-----------------|
| RS1G125 | SOT23-5(5) | 2.92mm×1.60mm |
| | SC70-5(5) | 2.10mm×1.25mm |

(1) For all available packages, see the orderable addendum at the end of the data sheet.

FUNCTION TABLE

| INPUTS | | OUTPUT |
|-----------------|---|--------|
| \overline{OE} | A | Y |
| L | H | H |
| L | L | L |
| H | X | Z |

H=HIGH Logic Level

L =LOW Logic Level

X=Don't Care

Z=High-impedance OFF-state

Revision History

Note: Page numbers for previous revisions may differ from page numbers in the current version.

| Version | Change Date | Change Item |
|---------|-------------|---|
| A.1 | 2021/02/05 | Initial version completed |
| A.2 | 2022/04/01 | 1.Added the TAPE AND REEL INFORMATION |
| A.3 | 2022/04/27 | Update PACKAGE MARKING on Page 5@RevA.2 |

PIN CONFIGURATIONS

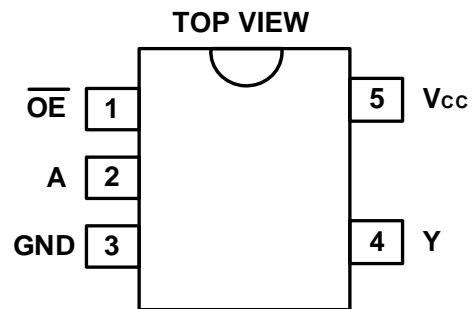

SOT23-5/SOT353(SC70-5)

PIN DESCRIPTION

| PIN | NAME | I/O TYPE | FUNCTION |
|-------------------------------|------------------------|----------|-------------------------------------|
| SOT23-5/SOT353(SC70-5) | | | |
| 1 | $\overline{\text{OE}}$ | I | $\overline{\text{OE}}$ Enable/Input |
| 2 | A | I | A Input |
| 3 | GND | - | Ground Pin |
| 4 | Y | O | Y Output |
| 5 | V _{cc} | - | Power Pin |

Specifications

Absolute Maximum Ratings ⁽¹⁾

over operating free-air temperature range (unless otherwise noted) ⁽¹⁾ ⁽²⁾

| | | MIN | MAX | UNIT |
|------------------|---|-------------------|----------------------|------|
| V _{CC} | Supply voltage range | -0.5 | 6.5 | V |
| V _I | Input voltage range ⁽²⁾ | -0.5 | 6.5 | V |
| V _O | Voltage range applied to any output in the high-impedance or power-off state ⁽²⁾ | -0.5 | 6.5 | V |
| V _O | Voltage range applied to any output in the high or low state ⁽²⁾ ⁽³⁾ | -0.5 | V _{CC} +0.5 | V |
| I _{IK} | Input clamp current | V _I <0 | -50 | mA |
| I _{OK} | Output clamp current | V _O <0 | -50 | mA |
| I _O | Continuous output current | | ±50 | mA |
| | Continuous current through V _{CC} or GND | | ±100 | mA |
| T _J | Junction temperature | -65 | 150 | °C |
| T _{stg} | Storage temperature | -65 | 150 | °C |

(1) Stresses beyond those listed under *Absolute Maximum Ratings* may cause permanent damage to the device. These are stress ratings only, and functional operation of the device at these or any other conditions beyond those indicated under *Recommended Operating Conditions* is not implied. Exposure to absolute-maximum-rated conditions for extended periods may affect device reliability.

(2) The input and output negative-voltage ratings may be exceeded if the input and output current ratings are observed.

(3) The value of V_{CC} is provided in the *Recommended Operating Conditions table*.

ESD Ratings

| | | VALUE | UNIT | |
|--------------------|-------------------------|------------------------|-------|---|
| V _(ESD) | Electrostatic discharge | Human-body model (HBM) | ±8000 | V |
| | | Machine model (MM) | ±500 | V |

Thermal Information:

| THERMAL METRIC | | RS1G125 | | UNIT |
|-----------------------|--|---------|----------------|------|
| | | 5PINS | | |
| | | SOT23-5 | SOT353(SC70-5) | |
| R _{θJA} | Junction-to-ambient thermal resistance | 273.8 | 214.7 | °C/W |
| R _{θJC(top)} | Junction-to-case(top) thermal resistance | 126.8 | 127.1 | °C/W |
| R _{θJB} | Junction-to-board thermal resistance | 85.9 | 60.0 | °C/W |
| Ψ _{JT} | Junction-to-top characterization parameter | 10.9 | 33.4 | °C/W |
| Ψ _{JB} | Junction-to-board characterization parameter | 84.9 | 59.8 | °C/W |
| R _{θJC(bot)} | Junction-to-case(bottom) thermal resistance | N/A | N/A | °C/W |

PACKAGE/ORDERING INFORMATION

| PRODUCT | ORDERING NUMBER | TEMPERATURE RANGE | PACKAGE LEAD | PACKAGE MARKING ⁽¹⁾ | PACKAGE OPTION |
|---------|-----------------|-------------------|----------------|--------------------------------|--------------------|
| RS1G125 | RS1G125XF5 | -40°C ~+125°C | SOT23-5 | 1G125 | Tape and Reel,3000 |
| | RS1G125XC5 | -40°C ~+125°C | SC70-5(SOT353) | 1G125 | Tape and Reel,3000 |

NOTE:

- (1) There may be additional marking, which relates to the lot trace code information (data code and vendor code), the logo or the environmental category on the device.

ELECTRICAL CHARACTERISTICS

over recommended operating free-air temperature range (TYP values are at $T_A = +25^\circ\text{C}$, unless otherwise noted.)⁽¹⁾

Recommended Operating Conditions

| PARAMETER | SYMBOL | TEST CONDITIONS | MIN | MAX | UNIT |
|-------------------------------|------------|--|----------------------|----------------------|------------------|
| Supply voltage | V_{CC} | Operating | 1.65 | 5.5 | V |
| | | Data retention only | 1.5 | 5.5 | |
| High-level input voltage | V_{IH} | $V_{CC}=1.65\text{V to }1.95\text{V}$ | $0.65 \times V_{CC}$ | | V |
| | | $V_{CC}=2.3\text{V to }2.7\text{V}$ | 1.7 | | |
| | | $V_{CC}=3\text{V to }3.6\text{V}$ | 2.2 | | |
| | | $V_{CC}=4.5\text{V to }5.5\text{V}$ | $0.7 \times V_{CC}$ | | |
| Low-level input voltage | V_{IL} | $V_{CC}=1.65\text{V to }1.95\text{V}$ | | $0.15 \times V_{CC}$ | V |
| | | $V_{CC}=2.3\text{V to }2.7\text{V}$ | | 0.3 | |
| | | $V_{CC}=3\text{V to }3.6\text{V}$ | | 0.4 | |
| | | $V_{CC}=4.5\text{V to }5.5\text{V}$ | | $0.15 \times V_{CC}$ | |
| Input voltage | V_I | | 0 | 5.5 | V |
| Output voltage | V_O | | 0 | V_{CC} | V |
| Input transition rise or fall | t_r, t_f | $V_{CC}=1.8\text{V} \pm 0.15\text{V}, 2.5\text{V} \pm 0.2\text{V}$ | | 20 | ns/V |
| | | $V_{CC}=3.3\text{V} \pm 0.3\text{V}$ | | 10 | |
| | | $V_{CC}=5\text{V} \pm 0.5\text{V}$ | | 5 | |
| Operating temperature | T_A | | -40 | +125 | $^\circ\text{C}$ |

Electrical Characteristics

| PARAMETER | TEST CONDITIONS | V_{CC} | TEMP | MIN | TYP | MAX | UNIT |
|-----------------|--|--------------------------|----------------------|----------------------|-----------|----------|---------------|
| V_{OH} | $I_{OH} = -100\mu\text{A}$ | 1.65V to 5.5V | Full | $V_{CC}-0.1$ | | | V |
| | $I_{OH} = -4\text{mA}$ | 1.65V | | 1.2 | | | |
| | $I_{OH} = -8\text{mA}$ | 2.3V | | 1.9 | | | |
| | $I_{OH} = -16\text{mA}$ | 3V | | 2.4 | | | |
| | $I_{OH} = -24\text{mA}$ | | | 2.3 | | | |
| | $I_{OH} = -32\text{mA}$ | 4.5V | | 3.8 | | | |
| V_{OL} | $I_{OL} = 100\mu\text{A}$ | 1.65V to 5.5V | Full | | | 0.1 | V |
| | $I_{OL} = 4\text{mA}$ | 1.65V | | | | 0.45 | |
| | $I_{OL} = 8\text{mA}$ | 2.3V | | | | 0.3 | |
| | $I_{OL} = 16\text{mA}$ | 3V | | | | 0.4 | |
| | $I_{OL} = 24\text{mA}$ | | | | | 0.55 | |
| | $I_{OL} = 32\text{mA}$ | 4.5V | | | | 0.55 | |
| I_i | A or \overline{OE} inputs | $V_I=5.5\text{V or GND}$ | 0V to 5.5V | +25 $^\circ\text{C}$ | ± 0.1 | ± 1 | μA |
| | | | | Full | | ± 5 | |
| I_{off} | V_I or $V_O=5.5\text{V}$ | 0V | +25 $^\circ\text{C}$ | | ± 0.1 | ± 1 | μA |
| | | | Full | | | ± 10 | |
| I_{oz} | $V_O=0\text{V to }5.5\text{V}$ | 3.6V | Full | | | 10 | μA |
| I_{CC} | $V_I=5.5\text{V or GND}, I_o=0$ | 1.65V to 5.5V | +25 $^\circ\text{C}$ | | 0.1 | 1 | μA |
| | | | Full | | | 10 | |
| ΔI_{CC} | One input at $V_{CC}-0.6\text{V}$, Other inputs at V_{CC} or GND | 3V to 5.5V | Full | | | 500 | μA |

Switching Characteristics, $C_L=15\text{pF}$

 over recommended operating free-air temperature range (-40°C to 125°C, unless otherwise noted.) ⁽¹⁾

| PARAMETER | FROM (INPUT) | TO (OUTPUT) | $V_{CC}=1.8\text{V}\pm 0.15\text{V}$ | $V_{CC}=2.5\text{V}\pm 0.2\text{V}$ | $V_{CC}=3.3\text{V}\pm 0.3\text{V}$ | $V_{CC}=5\text{V}\pm 0.5\text{V}$ | UNIT |
|-----------|--------------|-------------|--------------------------------------|-------------------------------------|-------------------------------------|-----------------------------------|------|
| | | | TYP | TYP | TYP | TYP | |
| t_{pd} | A | Y | 6.1 | 3.7 | 3.9 | 2.1 | ns |

Switching Characteristics, $C_L=30\text{pF}$ or 50pF

 over recommended operating free-air temperature range (-40°C to 125°C, unless otherwise noted.) ⁽¹⁾

| PARAMETER | FROM (INPUT) | TO (OUTPUT) | $V_{CC}=1.8\text{V}\pm 0.15\text{V}$ | $V_{CC}=2.5\text{V}\pm 0.2\text{V}$ | $V_{CC}=3.3\text{V}\pm 0.3\text{V}$ | $V_{CC}=5\text{V}\pm 0.5\text{V}$ | UNIT |
|-----------|-----------------|-------------|--------------------------------------|-------------------------------------|-------------------------------------|-----------------------------------|------|
| | | | TYP | TYP | TYP | TYP | |
| t_{pd} | A | Y | 8.6 | 5.3 | 4.0 | 2.9 | ns |
| t_{en} | \overline{OE} | Y | 9.5 | 5.8 | 5.0 | 3.3 | ns |
| t_{dis} | \overline{OE} | Y | 7.4 | 4.3 | 4.4 | 3.0 | ns |

Operating Characteristics
 $T_A=25^\circ\text{C}$

| PARAMETER | | | TEST CONDITIONS | $V_{CC}=1.8\text{V}$ | $V_{CC}=2.5\text{V}$ | $V_{CC}=3.3\text{V}$ | $V_{CC}=5\text{V}$ | UNIT |
|-----------|-------------------------------|-----------------|-----------------|----------------------|----------------------|----------------------|--------------------|------|
| | | | | TYP | TYP | TYP | TYP | |
| C_{pd} | Power dissipation capacitance | Output enabled | f=10MHz | 18 | 18 | 19 | 21 | pF |
| | | Output disabled | | 2 | 2 | 2 | 4 | |

 (1) All unused inputs of the device must be held at V_{CC} or GND to ensure proper device operation.

Parameter Measurement Information

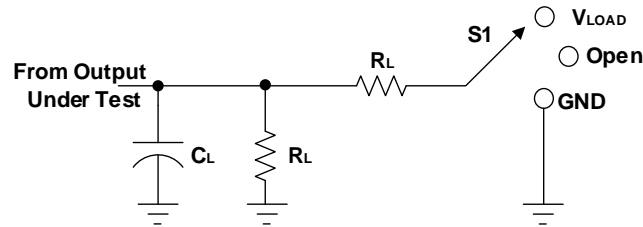

| TEST | S1 |
|-------------------|------------|
| t_{PLH}/t_{PHL} | Open |
| t_{PLZ}/t_{PZL} | V_{LOAD} |
| t_{PHZ}/t_{PZH} | GND |

| V_{CC} | INPUTS | | V_M | V_{LOAD} | C_L | R_L | V_{Δ} |
|------------------|----------|--------------|------------|-------------------|-------|-------------|--------------|
| | V_I | t_r/t_f | | | | | |
| $1.8V \pm 0.15V$ | V_{CC} | $\leq 2ns$ | $V_{CC}/2$ | $2 \times V_{CC}$ | 15pF | 1M Ω | 0.15V |
| $2.5V \pm 0.2V$ | V_{CC} | $\leq 2ns$ | $V_{CC}/2$ | $2 \times V_{CC}$ | 15pF | 1M Ω | 0.15V |
| $3.3V \pm 0.3V$ | 3V | $\leq 2.5ns$ | 1.5V | 6V | 15pF | 1M Ω | 0.3V |
| $5V \pm 0.5V$ | V_{CC} | $\leq 2.5ns$ | $V_{CC}/2$ | $2 \times V_{CC}$ | 15pF | 1M Ω | 0.3V |

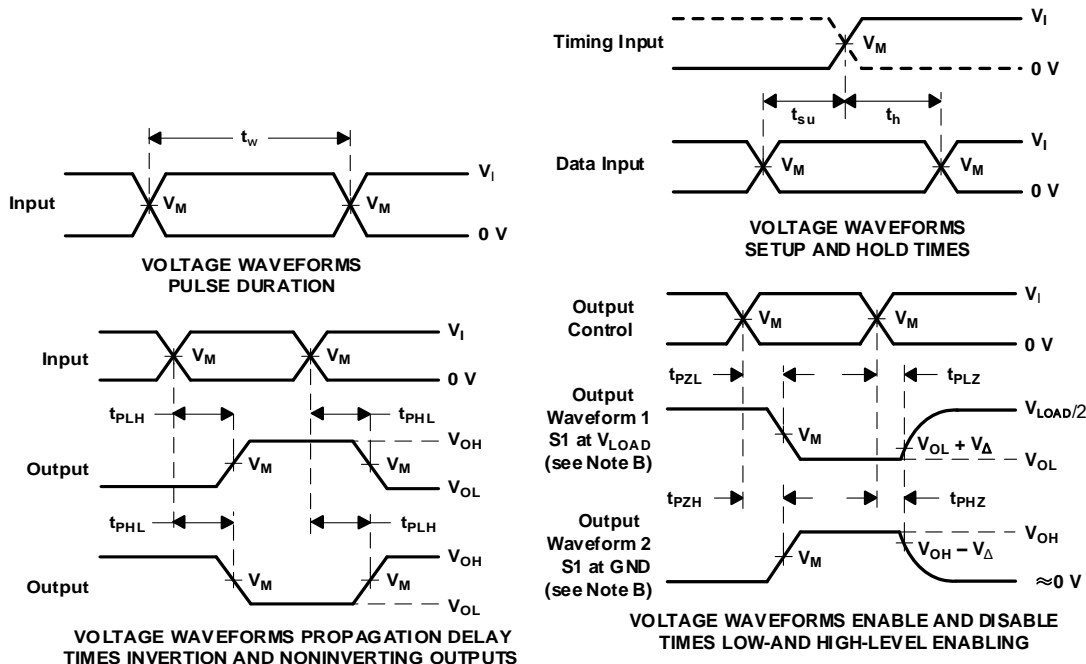

- NOTES:
- A. C_L includes probe and jig capacitance.
 - B. Waveform 1 is for an output with internal conditions such that the output is low, except when disabled by the output control. Waveform 2 is for an output with internal conditions such that the output is high, except when disabled by the output control.
 - C. All input pulses are supplied by generators having the following characteristics: $PRR \leq 10 \text{ MHz}$, $Z_o = 50 \Omega$.
 - D. The outputs are measured one at a time, with one transition per measurement.
 - E. t_{PLZ} and t_{PHZ} are the same as t_{dis} .
 - F. t_{PZL} and t_{PZH} are the same as t_{en} .
 - G. t_{PLH} and t_{PHL} are the same as t_{pd} .
 - H. All parameters and waveforms are not applicable to all devices.

Figure 1. Load Circuit and Voltage Waveforms

PACKAGE OUTLINE DIMENSIONS

SOT23-5

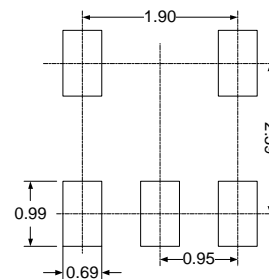
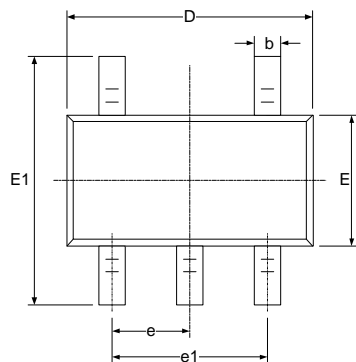
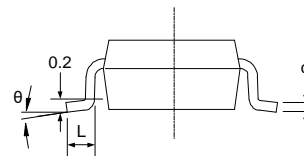
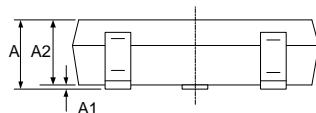
RECOMMENDED LAND PATTERN (Unit: mm)

| Symbol | Dimensions In Millimeters | | Dimensions In Inches | |
|----------|---------------------------|-------|----------------------|-------|
| | Min | Max | Min | Max |
| A | 1.050 | 1.250 | 0.041 | 0.049 |
| A1 | 0.000 | 0.100 | 0.000 | 0.004 |
| A2 | 1.050 | 1.150 | 0.041 | 0.045 |
| b | 0.300 | 0.500 | 0.012 | 0.020 |
| c | 0.100 | 0.200 | 0.004 | 0.008 |
| D | 2.820 | 3.020 | 0.111 | 0.119 |
| E | 1.500 | 1.700 | 0.059 | 0.067 |
| E1 | 2.650 | 2.950 | 0.104 | 0.116 |
| e | 0.950(BSC) | | 0.037(BSC) | |
| e1 | 1.800 | 2.000 | 0.071 | 0.079 |
| L | 0.300 | 0.600 | 0.012 | 0.024 |
| θ | 0° | 8° | 0° | 8° |

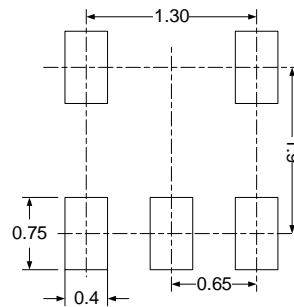
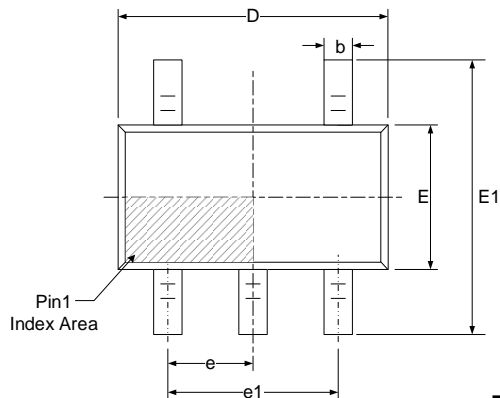
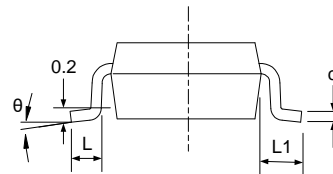
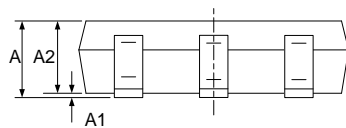
SOT353(SC70-5)

RECOMMENDED LAND PATTERN (Unit: mm)

| Symbol | Dimensions In Millimeters | | Dimensions In Inches | |
|--------|---------------------------|-------|----------------------|-------|
| | Min | Max | Min | Max |
| A | 0.900 | 1.100 | 0.035 | 0.043 |
| A1 | 0.000 | 0.100 | 0.000 | 0.004 |
| A2 | 0.900 | 1.000 | 0.035 | 0.039 |
| b | 0.150 | 0.350 | 0.006 | 0.014 |
| c | 0.080 | 0.150 | 0.003 | 0.006 |
| D | 2.000 | 2.200 | 0.079 | 0.087 |
| E | 1.150 | 1.350 | 0.045 | 0.053 |
| E1 | 2.150 | 2.450 | 0.085 | 0.096 |
| e | 0.650(BSC) | | 0.026(BSC) | |
| e1 | 1.300(BSC) | | 0.051(BSC) | |
| L | 0.260 | 0.460 | 0.010 | 0.018 |
| L1 | 0.525 | | 0.021 | |
| θ | 0° | 8° | 0° | 8° |

TAPE AND REEL INFORMATION

REEL DIMENSIONS

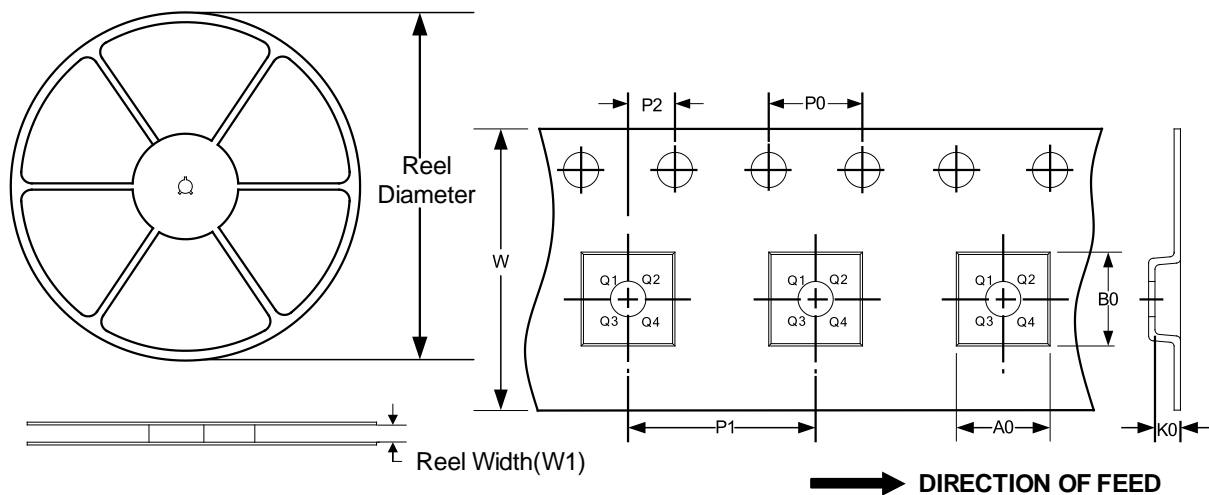
TAPE DIMENSION



NOTE: The picture is only for reference. Please make the object as the standard.

KEY PARAMETER LIST OF TAPE AND REEL

| Package Type | Reel Diameter | Reel Width(mm) | A0 (mm) | B0 (mm) | K0 (mm) | P0 (mm) | P1 (mm) | P2 (mm) | W (mm) | Pin1 Quadrant |
|----------------|---------------|----------------|---------|---------|---------|---------|---------|---------|--------|---------------|
| SOT353(SC70-5) | 7" | 9.5 | 2.25 | 2.55 | 1.20 | 4.0 | 4.0 | 2.0 | 8.0 | Q3 |
| SOT23-5 | 7" | 9.5 | 3.20 | 3.20 | 1.40 | 4.0 | 4.0 | 2.0 | 8.0 | Q3 |

单击下面可查看定价，库存，交付和生命周期等信息

[>>Runic\(润石\)](#)