

General-Purpose High-Voltage Open-Drain Output Dual Comparator

1 FEATURES

- **Qualified for Automotive Applications**
- **AEC-Q100 Qualified with the Grade 1**
- **Supply Range: +3.3V to +32V**
- **Low Supply Current**
55µA (TYP) per channel at $V_s = 5V$
- **Common-Mode Input Voltage Range Includes Ground**
- **Low Output Saturation Voltage**
- **Open-Drain Output for Maximum Flexibility**
- **SPECIFIED UP TO +125°C**
- **Micro SIZE PACKAGES: SOIC-8(SOP8), MSOP8**

2 APPLICATIONS

- **Hysteresis Comparators**
- **Factory Automation & Control**
- **Industrial Equipment**
- **Test and Measurement**
- **Cordless Power Tool**
- **Vacuum Robot**
- **Wireless Infrastructure**

3 DESCRIPTIONS

The LM2903-Q1 is the dual comparator version, and the outputs can be connected to other open-collector outputs to achieve wired-AND relationships. It can operate from 3.3V to 32V, and have low power consuming 55µA (TYP) per channel.

The LM2903-Q1 consist of two independent voltage comparators that are designed to operate from a single power supply over a wide range of voltages. Quiescent current is independent of the supply voltage. The device is the most cost-effective solutions for applications where low offset voltage, high supply voltage capability, low supply current, and space saving are the primary specifications in circuit design for portable consumer products.

The LM2903-Q1 is available in Green SOIC-8(SOP8) and MSOP8 packages. It operates over an ambient temperature range of -40°C to +125°C.

Device Information (1)

PART NUMBER	PACKAGE	BODY SIZE (NOM)
LM2903-Q1	SOIC-8(SOP8)	4.90mm×3.90mm
	MSOP-8	3.00mm×3.00mm

(1) For all available packages, see the orderable addendum at the end of the data sheet.

Table of Contents

1 FEATURES	1
2 APPLICATIONS	1
3 DESCRIPTIONS	1
4 Revision History	3
5 PACKAGE/ORDERING INFORMATION ⁽¹⁾	4
6 Pin Configuration and Functions (Top View)	5
7 SPECIFICATIONS	6
7.1 Absolute Maximum Ratings	6
7.2 ESD Ratings.....	6
7.3 Recommended Operating Conditions.....	6
7.4 ELECTRICAL CHARACTERISTICS.....	7
7.5 TYPICAL CHARACTERISTICS.....	9
8 Detailed Description	10
8.1 Overview	13
9 Application and Implementation	14
9.1 Application Information	14
9.2 Typical Application	14
9.3 Detailed Design Procedure	14
9.4 Input Voltage Range	14
10 Layout	15
10.1 Layout Guidelines	15
10.2 Layout Example	15
11 PACKAGE OUTLINE DIMENSIONS	16
12 TAPE AND REEL INFORMATION	18

4 Revision History

Note: Page numbers for previous revisions may differ from page numbers in the current version.

VERSION	Change Date	Change Item
A.1	2023/02/28	Initial version completed

5 PACKAGE/ORDERING INFORMATION (1)

Orderable Device	Package Type	Pin	Channel	Lead finish/Ball material (2)	MSL Peak Temp (3)	Op Temp(°C)	Device Marking (4)	Package Qty
LM2903XK-Q1	SOIC-8 (SOP8)	8	2	NIPDAUAG	MSL1-260°-Unlimited	-40°C ~+125°C	LM2903	Tape and Reel,4000
LM2903XM-Q1	MSOP-8	8	2	NIPDAUAG	MSL1-260°-Unlimited	-40°C ~+125°C	LM2903	Tape and Reel,4000

NOTE:

- (1) This information is the most current data available for the designated devices. This data is subject to change without notice and revision of this document. For browser-based versions of this data sheet, refer to the right-hand navigation.
- (2) Lead finish/Ball material. Orderable Devices may have multiple material finish options. Finish options are separated by a vertical ruled line. Lead finish/Ball material values may wrap to two lines if the finish value exceeds the maximum column width.
- (3) MSL Peak Temp. The Moisture Sensitivity Level rating according to the JEDEC industry standard classifications, and peak solder temperature.
- (4) There may be additional marking, which relates to the lot trace code information(data code and vendor code), the logo or the environmental category on the device.

6 Pin Configuration and Functions (Top View)

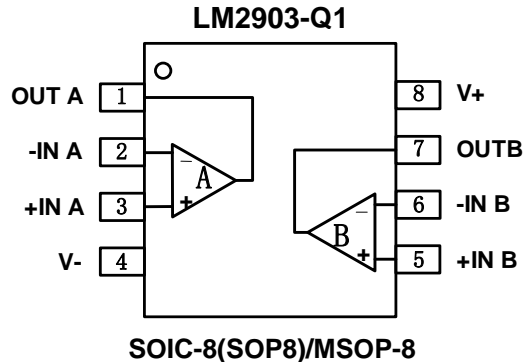

Pin Description

NAME	PIN	I/O ⁽¹⁾	DESCRIPTION
	SOIC-8(SOP8)/MSOP-8		
OUTA	1	O	Output, channel A
-INA	2	I	Inverting input, channel A
+INA	3	I	Noninverting input, channel A
V-	4	P	Negative (lowest) power supply
+INB	5	I	Noninverting input, channel B
-INB	6	I	Inverting input, channel B
OUTB	7	O	Output, channel B
V+	8	P	Positive (highest) power supply

(1) I=Input, O=Output, P=Power.

7 SPECIFICATIONS

7.1 Absolute Maximum Ratings

Over operating free-air temperature range (unless otherwise noted) ⁽¹⁾

		MIN	MAX	UNIT
Voltage	Supply, $V_S=(V+) - (V-)$		36	V
	Input pin (IN+, IN-) ⁽²⁾	(V-)-0.3	(V+) +0.3	
	Signal output pin ⁽³⁾	(V-)-0.3	(V+) +0.3	
Current	Signal input pin (IN+, IN-) ⁽²⁾	-10	10	mA
	Signal output pin ⁽³⁾	-55	55	mA
	Output short-circuits ⁽⁴⁾	Continuous		
θ_{JA}	Package thermal impedance ⁽⁵⁾	SOIC-8(SOP8)	110.88	°C/W
		MSOP-8	165.7	
Temperature	Operating range, T_A	-40	125	°C
	Junction, T_J ⁽⁶⁾	-40	150	
	Storage, T_{stg}	-65	150	

(1) Stresses above these ratings may cause permanent damage. Exposure to absolute maximum conditions for extended periods may degrade device reliability. These are stress ratings only, and functional operation of the device at these or any other conditions beyond those specified is not implied.

(2) Input terminals are diode-clamped to the power-supply rails. Input signals that can swing more than 0.3V beyond the supply rails should be current-limited to 10mA or less.

(3) Output terminals are diode-clamped to the power-supply rails. Output signals that can swing more than 0.3V beyond the supply rails should be current-limited to ± 55 mA or less.

(4) Short-circuit from output to V_{CC} can cause excessive heating and eventual destruction.

(5) The package thermal impedance is calculated in accordance with JESD-51.

(6) The maximum power dissipation is a function of $T_{J(MAX)}$, $R_{\theta JA}$, and T_A . The maximum allowable power dissipation at any ambient temperature is $P_D = (T_{J(MAX)} - T_A) / R_{\theta JA}$. All numbers apply for packages soldered directly onto a PCB.

7.2 ESD Ratings

The following ESD information is provided for handling of ESD-sensitive devices in an ESD protected area only.

		VALUE	UNIT
$V_{(ESD)}$ Electrostatic discharge	Human-Body Model (HBM), per AEC Q100-002 ⁽¹⁾	± 2000	V
	Charged-Device Model (CDM), per AEC Q100-011	± 500	
	Latch-Up (LU), per AEC Q100-004	± 100	mA

(1) AEC Q100-002 indicates that HBM stressing shall be in accordance with the ANSI/ESDA/JEDEC JS-001 specification.



ESD SENSITIVITY CAUTION

ESD damage can range from subtle performance degradation to complete device failure. Precision integrated circuits may be more susceptible to damage because very small parametric changes could cause the device not to meet its published specifications.

7.3 Recommended Operating Conditions

Over operating free-air temperature range (unless otherwise noted)

		MIN	NOM	MAX	UNIT
Supply voltage, $V_S=(V+) - (V-)$	Single-supply	3.3		32	V
	Dual-supply	± 1.65		± 16	

7.4 ELECTRICAL CHARACTERISTICS

(At $T_A = +25^\circ\text{C}$, $V_{CM}=(V_S/2)$, $V_S=5\text{V}$, unless otherwise noted.)⁽¹⁾

PARAMETER		CONDITIONS	LM2903-Q1			UINT
			MIN ⁽²⁾	TYP ⁽³⁾	MAX ⁽²⁾	
V_S	Operating Voltage Range		3.3		32	V
I_Q	Quiescent Current	$V_S=5\text{V}$, no load		110	180	uA
		$V_S=32\text{V}$, no load, $T_A=-40^\circ\text{C}$ to $+125^\circ\text{C}$			250	
V_{OS}	Input offset voltage	$V_S=5\text{V}$ to 32V	-4.5	± 0.8	4.5	mV
		$V_S=5\text{V}$ to 32V $T_A=-40^\circ\text{C}$ to $+125^\circ\text{C}$	-5		5	
I_B	Input Bias Current ^{(4) (5)}	$T_A=25^\circ\text{C}$		10	50	pA
		$T_A=-40^\circ\text{C}$ to $+125^\circ\text{C}$			50	nA
I_{OS}	Input Offset Current ⁽⁴⁾	$T_A=25^\circ\text{C}$		10	50	pA
		$T_A=-40^\circ\text{C}$ to $+125^\circ\text{C}$			50	nA
V_{CM}	Common-Mode Voltage Range ⁽⁶⁾	$V_S=3.3\text{V}$ to 32V	(V-)		(V+)-1.5	V
		$V_S=3.3\text{V}$ to 32V $T_A=-40^\circ\text{C}$ to $+125^\circ\text{C}$	(V-)		(V+)-2.0	
A_{VD}	Large signal differential voltage amplification	$V_S=15\text{V}$, $V_O=1.4\text{V}$ to 11.4V , $R_L \geq 15\text{k}$ to (V+)	20	100		V/mV
V_{OL}	Low-Level output voltage	$I_{SINK} \leq 4\text{mA}$, $V_{ID} = -0.5\text{V}$		200	350	mV
		$I_{SINK} \leq 4\text{mA}$, $V_{ID} = -0.5\text{V}$ $T_A = -40^\circ\text{C}$ to $+125^\circ\text{C}$			550	
I_{OL}	Output Current(sinking)	$V_O = 2.5\text{V}$; $V_{ID} = -0.5\text{V}$	12	29		mA
I_{OH-LKG}	High-Level Output Leakage Current	(V+) = $V_O = 5\text{V}$; $V_{ID} = 0.5\text{V}$		15	80	nA
		(V+) = $V_O = 32\text{V}$; $V_{ID} = 0.5\text{V}$		20	100	nA
Switching Characteristics						
T_{PHL}	Propagation Delay H To L ⁽⁷⁾	$V_S=5\text{V}$	RPU=5.1K Ω Overdrive =10mV		2.5	us
			RPU=5.1K Ω Overdrive =100mV		0.5	
		$V_S=32\text{V}$	RPU=5.1K Ω Overdrive =10mV		1.8	
			RPU=5.1K Ω Overdrive =100mV		0.7	
T_{PLH}	Propagation Delay L To H ⁽⁷⁾	$V_S=5\text{V}$	RPU=5.1K Ω Overdrive =10mV		4.1	
			RPU=5.1K Ω Overdrive =100mV		1.6	
		$V_S=32\text{V}$	RPU=5.1K Ω Overdrive =10mV		3.1	
			RPU=5.1K Ω Overdrive =100mV		1.4	

NOTE:

- (1) Electrical table values apply only for factory testing conditions at the temperature indicated. Factory testing conditions result in very limited self-heating of the device.
- (2) Limits are 100% production tested at 25°C. Limits over the operating temperature range are ensured through correlations using statistical quality control (SQC) method.
- (3) Typical values represent the most likely parametric norm as determined at the time of characterization. Actual typical values may vary over time and will also depend on the application and configuration.
- (4) This parameter is ensured by design and/or characterization and is not tested in production.
- (5) Positive current corresponds to current flowing into the device.
- (6) The voltage at either the input or common mode should not be allowed to negative by more than 0.3 V. The upper end of the common-mode voltage range is $(V+) - 1.5\text{ V}$; however, one input can exceed V_s , and the comparator will provide a proper output state as long as the other input remains in the common-mode range. Either or both inputs can go to 32 V without damage.
- (7) High-to-low and low-to-high refers to the transition at the input.

7.5 TYPICAL CHARACTERISTICS

NOTE: The graphs and tables provided following this note are a statistical summary based on a limited number of samples and are provided for informational purposes only.

At $T_A = +25^\circ\text{C}$, $V_S=5\text{V}$, $R_{\text{PULLUP}}=5.1\text{k}$, $V_{\text{CM}} = V_S/2$, $C_L=15\text{pF}$, unless otherwise noted.

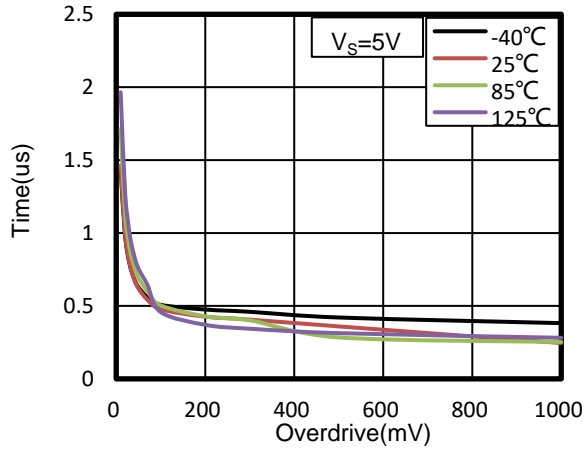

Figure 1. Response Time vs Input Overdrives Negative Transition

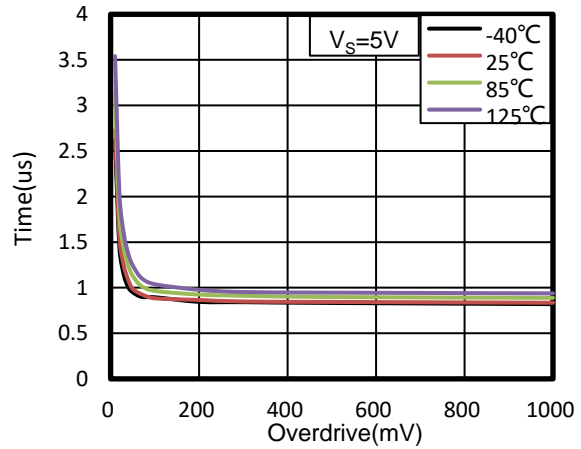

Figure 2. Response Time vs Input Overdrives Positive Transition

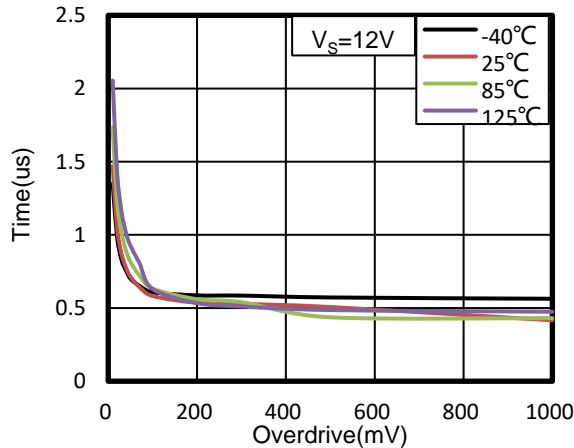

Figure 3. Response Time vs Input Overdrives Negative Transition

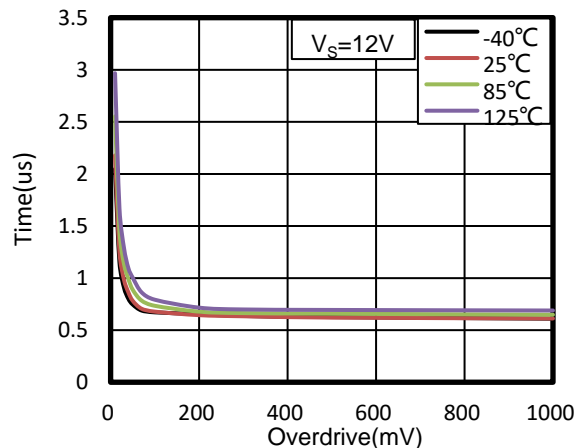

Figure 4. Response Time vs Input Overdrives Positive Transition

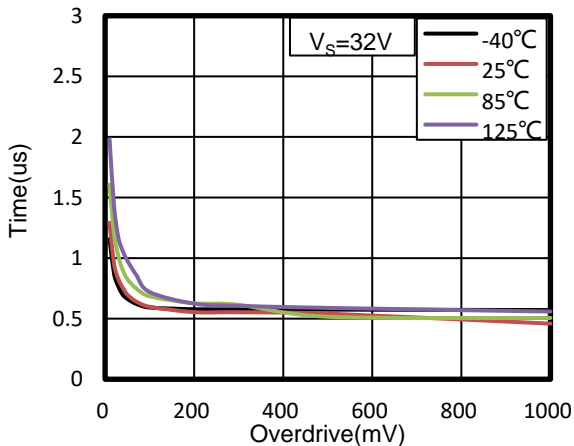

Figure 5. Response Time vs Input Overdrives Negative Transition

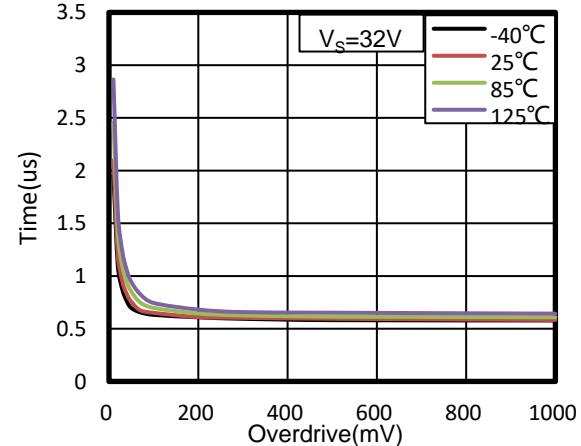

Figure 6. Response Time vs Input Overdrives Positive Transition

TYPICAL CHARACTERISTICS

NOTE: The graphs and tables provided following this note are a statistical summary based on a limited number of samples and are provided for informational purposes only.

At $T_A = +25^\circ\text{C}$, $V_S=5\text{V}$, $R_{\text{PULLUP}}=5.1\text{k}$, $V_{\text{CM}} = V_S/2$, $C_L=15\text{pF}$, unless otherwise noted.

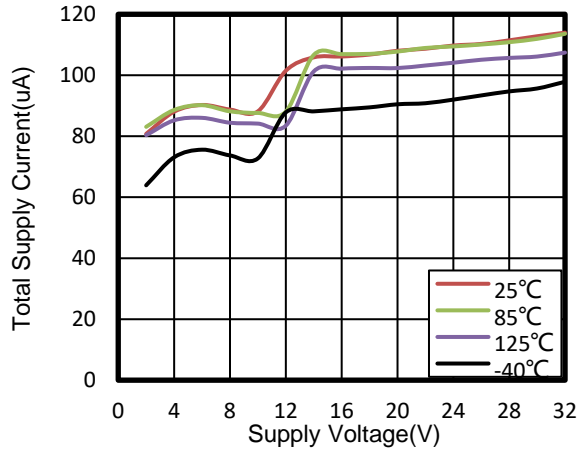

Figure 7. Total Supply Current vs Supply Voltage

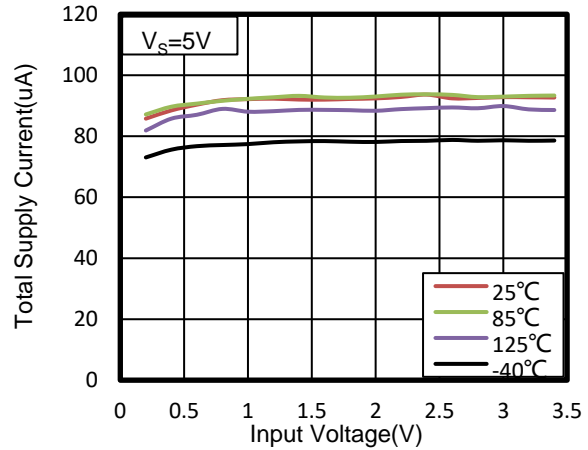

Figure 8. Total Supply Current vs Input Voltage

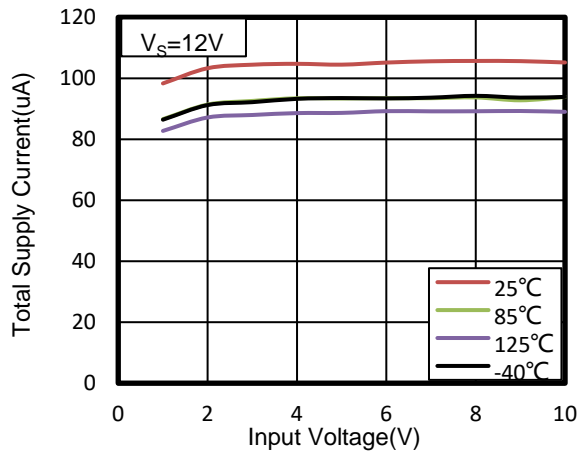

Figure 9. Total Supply Current vs Input Voltage

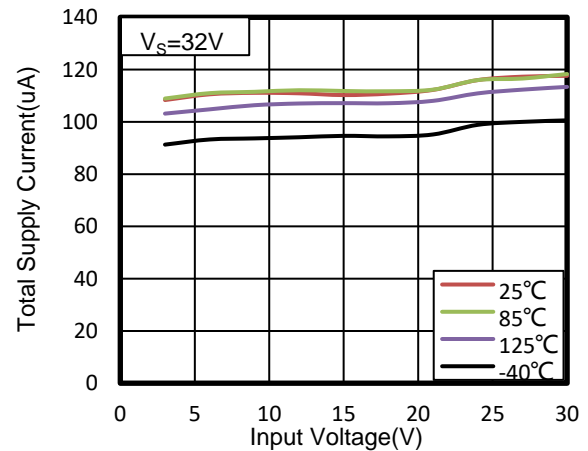

Figure 10. Total Supply Current vs Input Voltage

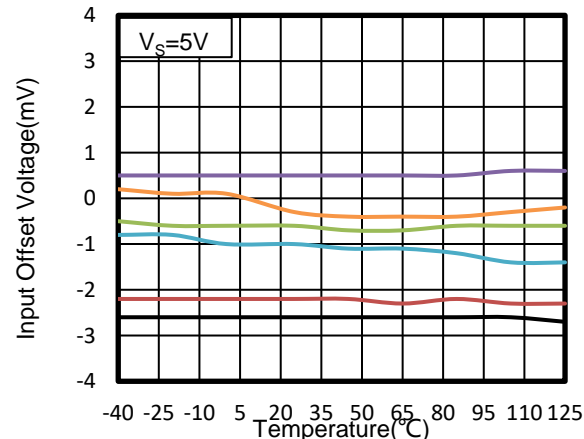

Figure 11. Input Offset Voltage vs Temperature

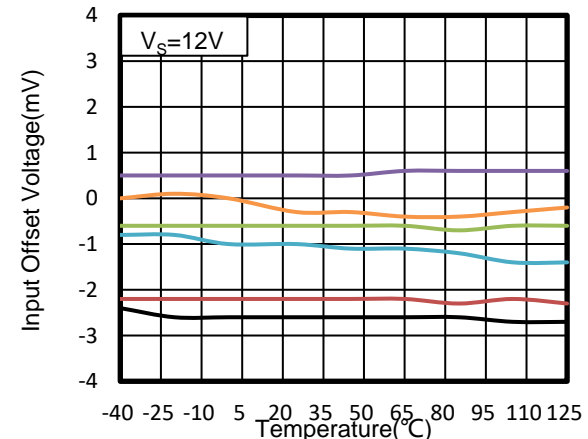

Figure 12. Input Offset Voltage vs Temperature

TYPICAL CHARACTERISTICS

NOTE: The graphs and tables provided following this note are a statistical summary based on a limited number of samples and are provided for informational purposes only.

At $T_A = +25^\circ\text{C}$, $V_S=5\text{V}$, $R_{\text{PULLUP}}=5.1\text{k}$, $V_{\text{CM}} = V_S/2$, $C_L=15\text{pF}$, unless otherwise noted.

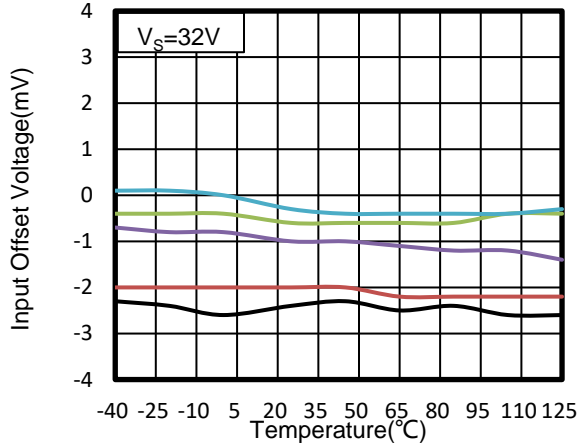

Figure 13. Input Offset Voltage vs Temperature

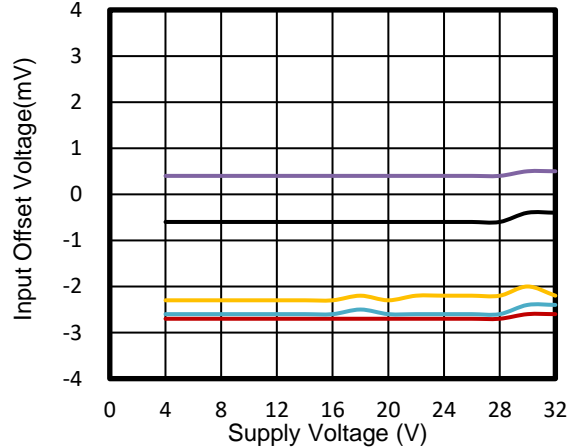

Figure 14. Input Offset Voltage vs Supply Voltage at -40°C

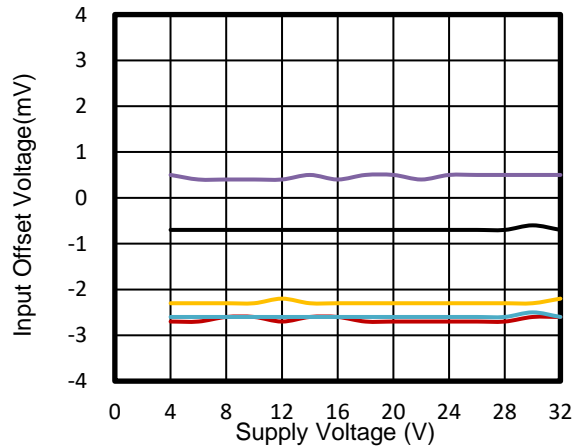

Figure 15. Input Offset Voltage vs Supply Voltage at 25°C

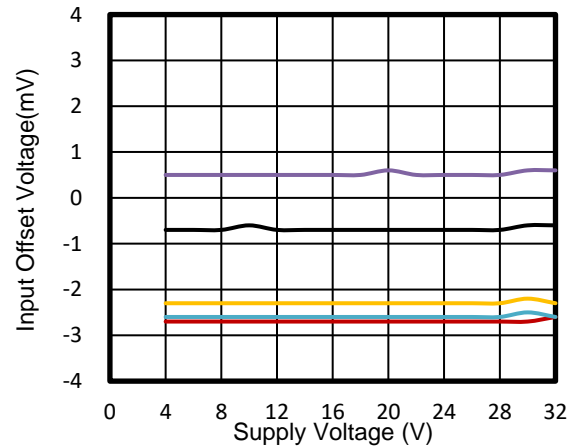

Figure 16. Input Offset Voltage vs Supply Voltage at 85°C

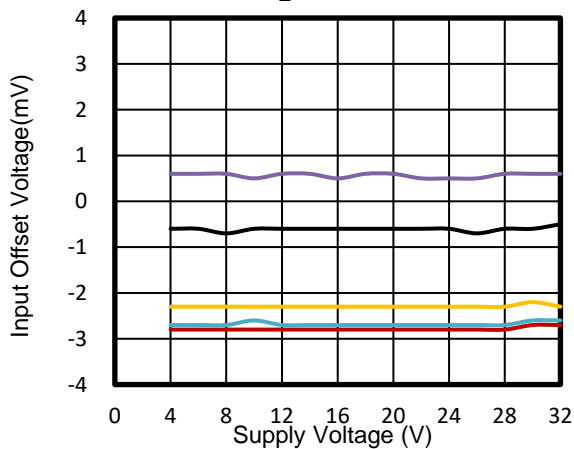

Figure 17. Input Offset Voltage vs Supply Voltage at 125°C

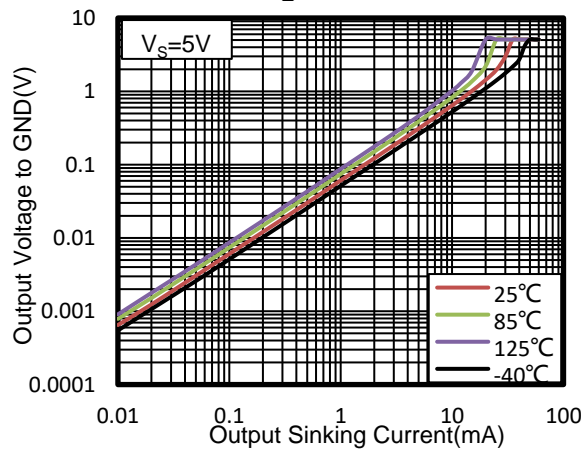

Figure 18. Output Low Voltage vs Output Sinking Current

TYPICAL CHARACTERISTICS

NOTE: The graphs and tables provided following this note are a statistical summary based on a limited number of samples and are provided for informational purposes only.

At $T_A = +25^\circ\text{C}$, $V_S=5\text{V}$, $R_{\text{PULLUP}}=5.1\text{k}$, $V_{\text{CM}} = V_S/2$, $C_L=15\text{pF}$, unless otherwise noted.

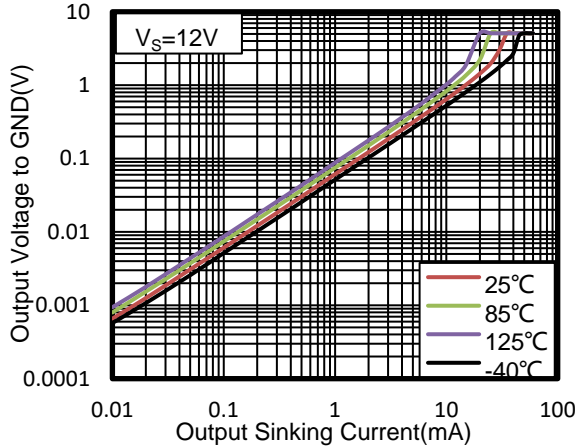

Figure 19. Output Low Voltage vs Output Sinking Current

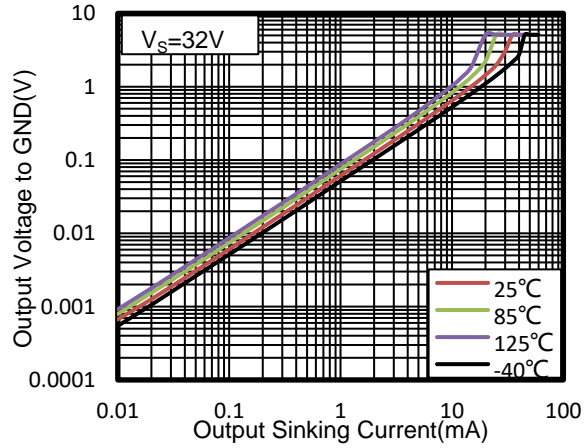

Figure 20. Output Low Voltage vs Output Sinking Current

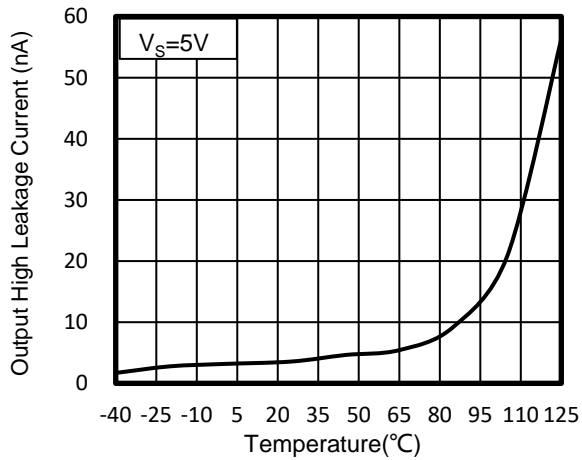

Figure 21. Output High Leakage Current vs Temperature

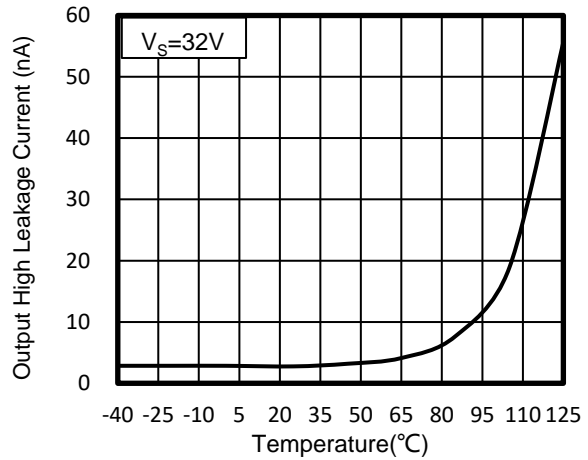

Figure 22. Output High Leakage Current vs Temperature

8 Detailed Description

8.1 Overview

The LM2903-Q1 family of comparators can operate up to 32V on the supply pin. This standard device has proven ubiquity and versatility across a wide range of applications. This is due to its low power and high speed. The open-drain output allows the user to configure the output's logic low voltage (V_{OL}) and can be utilized to enable the comparator to be used in AND functionality.

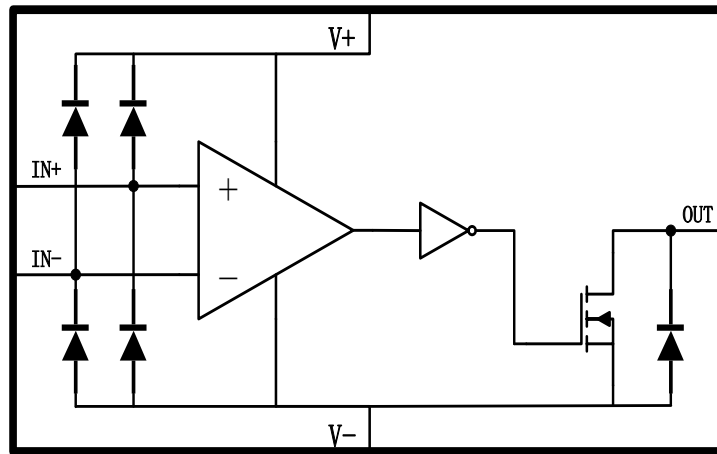

Figure 23. Functional Block Diagram

9 Application and Implementation

Information in the following applications sections is not part of the Runic component specification, and Runic does not warrant its accuracy or completeness. Runic's customers are responsible for determining suitability of components for their purposes. Customers should validate and test their design implementation to confirm system functionality.

9.1 Application Information

LM2903-Q1 is typically used to compare a single signal to a reference or two signals against each other. Many users take advantage of the open drain output (logic high with pull-up) to drive the comparison logic output to a logic voltage level to an MCU or logic device. The wide supply range and high voltage capability makes this comparator optimal for level shifting to a higher or lower voltage.

9.2 Typical Application

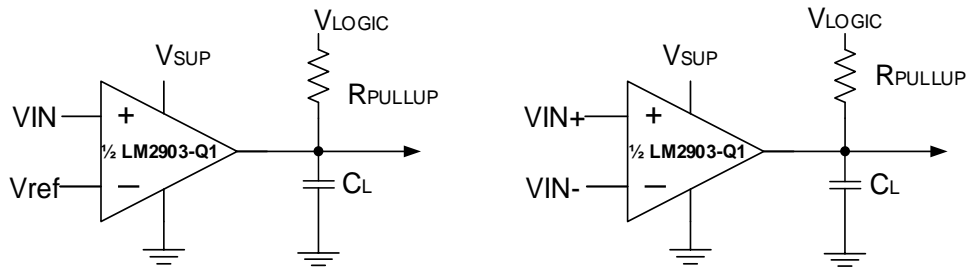

Figure 24. Single-Ended and Differential Comparator Configurations

9.3 Detailed Design Procedure

When using the device in a general comparator application, determine the following:

- Input Voltage Range
- Minimum Overdrive Voltage
- Output and Drive Current
- Response Time

9.4 Input Voltage Range

When choosing the input voltage range, the input common mode voltage range (V_{ICR}) must be taken in to account. If temperature operation is below 25°C the V_{ICR} can range from 0 V to $V_{CC} - 2.0$ V. This limits the input voltage range to as high as $V_{CC} - 2.0$ V and as low as 0 V. Operation outside of this range can yield incorrect comparisons.

10 Layout

10.1 Layout Guidelines

For accurate comparator applications without hysteresis, it is important maintain a stable power supply with minimized noise and glitches. To achieve this, it is best to add a bypass capacitor between the supply voltage and ground. This should be implemented on the positive power supply and negative supply (if available). If a negative supply is not being used, do not put a capacitor between the IC's GND pin and system ground. Minimize coupling between outputs and inverting inputs to prevent output oscillations. Do not run output and inverting input traces in parallel unless there is a V_{CC} or GND trace between output and inverting input traces to reduce coupling. When series resistance is added to inputs, place resistor close to the device.

10.2 Layout Example

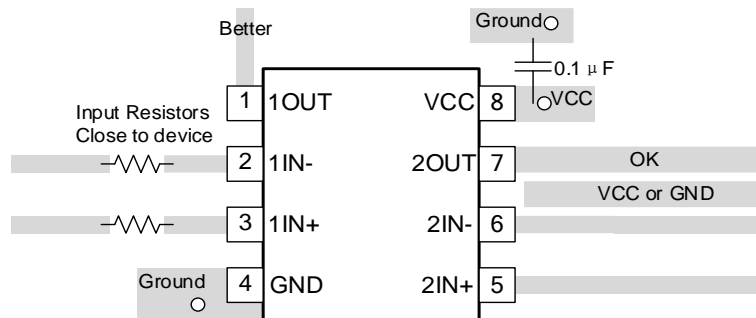
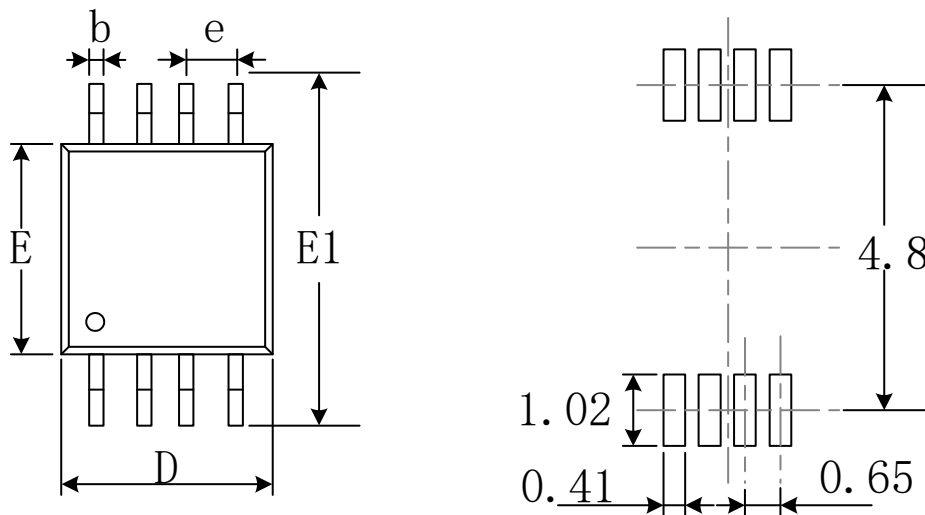
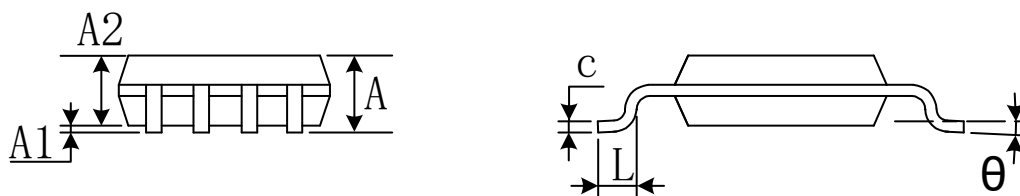
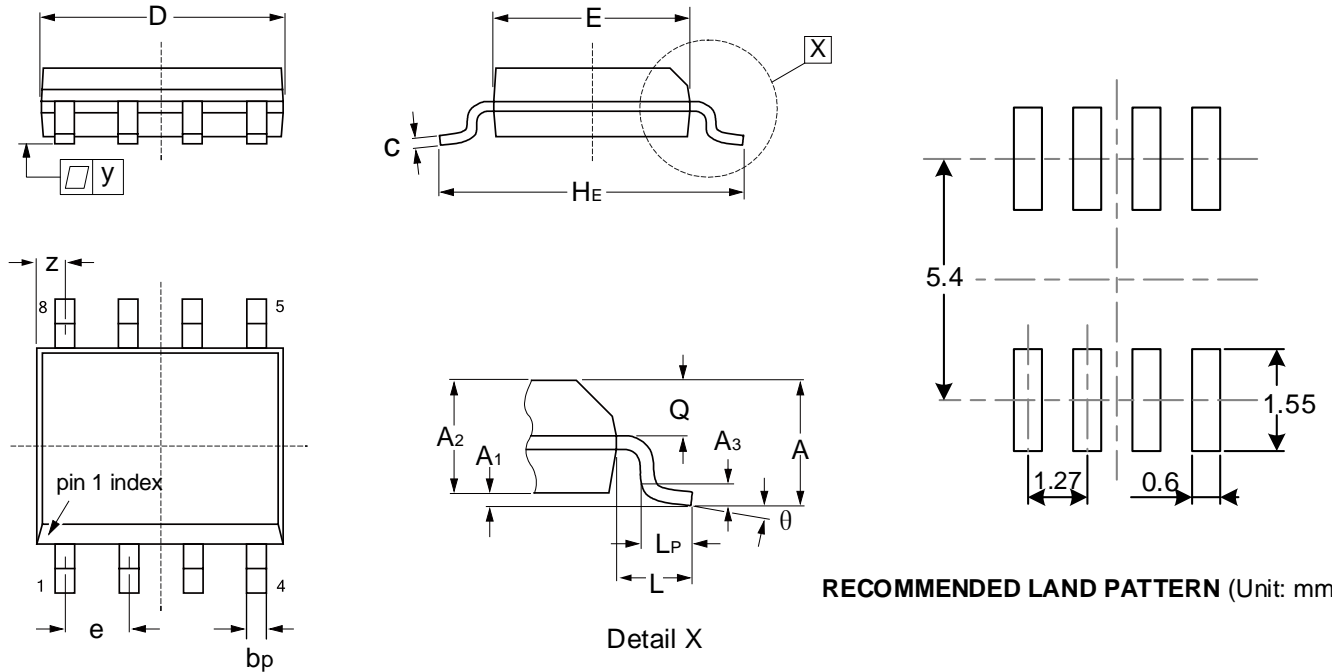

Figure 25. LM2903-Q1 Layout Example

**11 PACKAGE OUTLINE DIMENSIONS
MSOP-8**

RECOMMENDED LAND PATTERN (Unit: mm)

Symbol	Dimensions In Millimeters		Dimensions In Inches	
	Min	Max	Min	Max
A	0.820	1.100	0.032	0.043
A1	0.020	0.150	0.001	0.006
A2	0.750	0.950	0.030	0.037
b	0.250	0.380	0.010	0.015
c	0.090	0.230	0.004	0.009
D	2.900	3.100	0.114	0.122
e	0.650(BSC)		0.026(BSC)	
E	2.900	3.100	0.114	0.122
E1	4.750	5.050	0.187	0.199
L	0.400	0.800	0.016	0.031
θ	0°	6°	0°	6°

SOIC-8(SOP8)

Symbol	Dimensions In Millimeters		Dimensions In Inches	
	Min	Max	Min	Max
A		1.750		0.069
A ₁	0.100	0.250	0.004	0.010
A ₂	1.250	1.450	0.049	0.057
A ₃	0.25		0.010	
b _p	0.360	0.490	0.014	0.019
c	0.190	0.250	0.007	0.010
D ^(A)	4.800	5.000	0.190	0.200
E ^(B)	3.800	4.000	0.150	0.160
H _E	5.800	6.200	0.228	0.244
e	1.270		0.050	
L	1.05		0.041	
L _P	0.400	1.000	0.016	0.039
Q	0.600	0.700	0.024	0.028
Z ^(A)	0.300	0.700	0.012	0.028
y	0.1		0.004	
θ	0°	8°	0°	8°

NOTE:

- A. Plastic or metal protrusions of 0.15mm (0.006 inch) maximum per side are not included.
- B. Plastic or metal protrusions of 0.25mm (0.01 inch) maximum per side are not included.
- C. All linear dimension is in millimeters.
- D. This drawing is subject to change without notice.
- E. Body dimensions do not include mold flash or protrusion. Mold flash and protrusion shall not exceed 0.15 per side.

12 TAPE AND REEL INFORMATION

REEL DIMENSIONS

TAPE DIMENSION

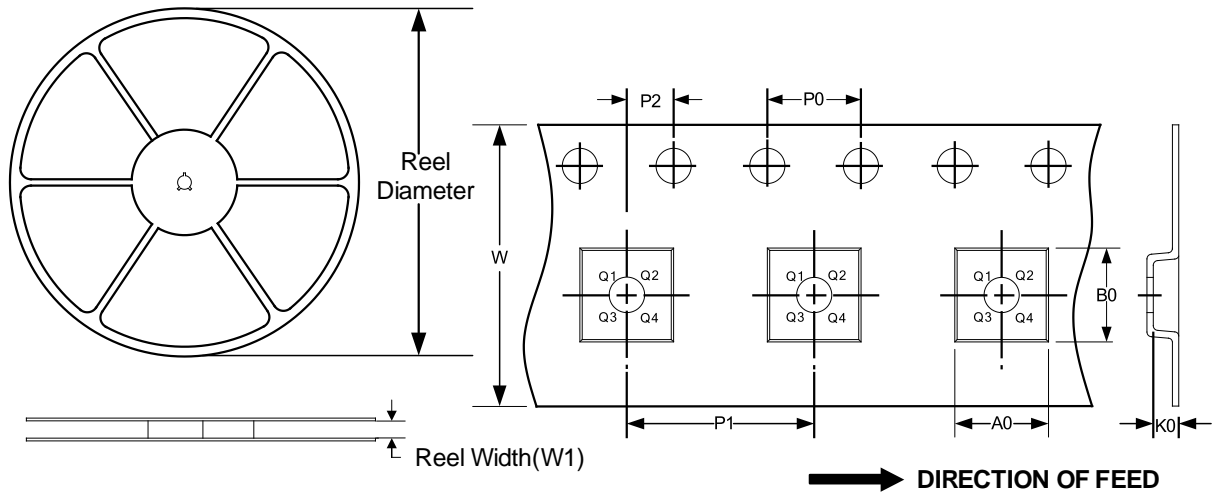

NOTE: The picture is only for reference. Please make the object as the standard.

KEY PARAMETER LIST OF TAPE AND REEL

Package Type	Reel Diameter	Reel Width (mm)	A0 (mm)	B0 (mm)	K0 (mm)	P0 (mm)	P1 (mm)	P2 (mm)	W (mm)	Pin1 Quadrant
SOIC-8(SOP8)	13"	12.4	6.40	5.40	2.10	4.0	8.0	2.0	12.0	Q1
MSOP-8	13"	12.4	5.20	3.30	1.50	4.0	8.0	2.0	12.0	Q1

NOTE:

1. All dimensions are nominal.
2. Plastic or metal protrusions of 0.15mm maximum per side are not included.

IMPORTANT NOTICE AND DISCLAIMER

Jiangsu Runic Technology Co., Ltd. will accurately and reliably provide technical and reliability data (including data sheets), design resources (including reference designs), application or other design advice, WEB tools, safety information and other resources, without warranty of any defect, and will not make any express or implied warranty, including but not limited to the warranty of merchantability Implied warranty that it is suitable for a specific purpose or does not infringe the intellectual property rights of any third party.

These resources are intended for skilled developers designing with Runic products You will be solely responsible for: (1) Selecting the appropriate products for your application; (2) Designing, validating and testing your application; (3) Ensuring your application meets applicable standards and any other safety, security or other requirements; (4) Runic and the Runic logo are registered trademarks of Runic Incorporated. All trademarks are the property of their respective owners; (5) For change details, review the revision history included in any revised document. The resources are subject to change without notice. Our company will not be liable for the use of this product and the infringement of patents or third-party intellectual property rights due to its use.

单击下面可查看定价，库存，交付和生命周期等信息

[>>Runic\(润石\)](#)