

Specification Sheet

CIGT201610UM1R0MNE (2016 / EIA 0806)

APPLICATION

Smart phones, Tablet, Wearable devices, Power converter modules, etc.



FEATURES

Small power inductor for mobile devices
Low DCR structure and high efficiency inductor for power circuits.
Monolithic structure for high reliability
Free of all RoHS-regulated substances
Halogen free

RECOMMENDED LAND PATTERN

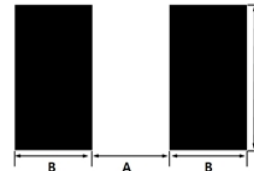

Unit : mm

TYPE	2016
A	0.8
B	0.8
C	1.8

DIMENSION

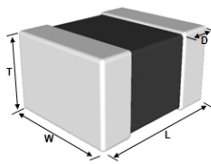

TYPE	Dimension [mm]			
	L	W	T	D
2016	2.0±0.2	1.6±0.2	1.0 max	0.5±0.2

DESCRIPTION

Part no.	Size [inch/mm]	Thickness [mm] (max)	Inductance [uH]	Inductance tolerance (%)	DC Resistance [mΩ]		Rated DC Current (Isat) [A]		Rated DC Current (Irms) [A]	
					Max.	Typ.	Max.	Typ.	Max.	Typ.
CIGT201610UM1R0MNE	0806/2016	1.0	1.0	±20	57	48	3.1	3.45	2.8	3.1

* Inductance : Measured with a LCR meter 4991A(Agilent) or equivalent (Test Freq. 1MHz, Level 0.1V)

* DC Resistance : Measured with a Resistance HI-TESTER 3541(HIOKI) or equivalent

* Maximum allowable DC current : Value defined when DC current flows and the nominal value of inductance has decreased by 30% or when current flows and temperature has risen to 40°C whichever is smaller. (Reference: ambient temperature is 25°C±10)

(Isat) : Allowable current in DC saturation : The DC saturation allowable current value is specified when the decrease of the nominal inductance value at 30% (Reference: ambient temperature is 25°C±10)

(Irms) : Allowable current of temperature rise : The temperature rise allowable current value is specified when temperature of the inductor is raised 40°C by DC current. (Reference: ambient temperature is 25°C±10)

* Absolute maximum voltage : Rated Voltage 20V.

* Operating temperature range : -40 to +125°C (Including self-temperature rise)

PRODUCT IDENTIFICATION

CIG (1) T (2) 2016 (3) 10 (4) UM (5) 1R0 (6) M (7) N (8) E (9)

(1) Power Inductor

(3) Dimension (2016: 2.0mm x1.6 mm)

(5) Remark (Characterization Code)

(7) Tolerance (M:±20%)

(8) Internal Code

(9) Packaging (C:paper tape, E:embossed tape)

(2) Type (T: Metal Composite Thin Film Type)

(4) Thickness (10: 1.0mm)

(6) Inductance (1R0: 1.0 uH)

RECOMMENDED SOLDERING CONDITION

REFLOW SOLDERING

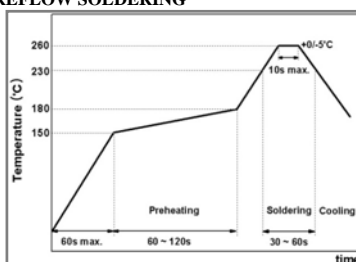

FLOW SOLDERING

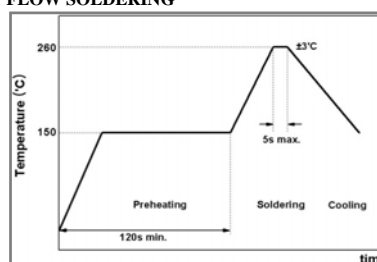

PACKAGING

Packaging Style	Quantity(pcs/reel)
Embossed Taping	3000 pcs

Reliability Test

Item	Specified Value	Test Condition	
Solderability	More than 90% of terminal electrode should be soldered newly.	After being dipped in flux for 4±1 seconds, and preheated at 150~180℃ for 2~3 min, the specimen shall be immersed in solder at 245±5℃ for 4±1 seconds.	
Resistance to Soldering	No mechanical damage. Remaining terminal Electrode: 75% min. Inductance change to be within ±20% to the initial.	After being dipped in flux for 4±1 seconds, and preheated at 150~180℃ for 2~3 min, the specimen shall be immersed in solder at 260±5℃ for 10 ±0.5 seconds.	
Thermal Shock (Temperature Cycle test)	No mechanical damage Inductance change to be within ±20% to the initial.	Repeat 100 cycles under the following conditions. -40±3℃ for 30 min → 85±3℃ for 30 min	
High Temp. Humidity Resistance Test	No mechanical damage Inductance change to be within ±20% to the initial	85±2℃, 85%RH, for 500±12 hours. Measure the test items after leaving at normal temperature and humidity for 24 hours.	
Low Temperature Test	No mechanical damage Inductance change to be within ±20% to the initial.	Solder the sample on PCB. Exposure at -55±2℃ for 500±12 hours. Measure the test items after leaving at normal temperature and humidity for 24hours.	
High Temperature Test	No mechanical damage Inductance change to be within ±20% to the initial.	Solder the sample on PCB. Exposure at 125±2℃ for 500±12 hours. Measure the test items after leaving at normal temperature and humidity for 24hours.	
High Temp. Humidity Resistance Loading Test	No mechanical damage Inductance change to be within ±20% to the initial	85±2℃, 85%RH, Rated Current for 500±12 hours. Measure the test items after leaving at normal temperature and humidity for 24 hours.	
High Temperature Loading Test	No mechanical damage Inductance change to be within ±20% to the initial	85±2℃, Rated Current for 500±12 hours. Measure the test items after leaving at normal temperature and humidity for 24 hours.	
Reflow Test	No mechanical damage Inductance change to be within ±20% to the initial	Peak 260±5℃, 3 times	
Vibration Test	No mechanical damage Inductance change to be within ±20% to the initial.	Solder the sample on PCB. Vibrate as apply 10~55Hz, 1.5mm amplitude for 2 hours in each of three(X,Y,Z) axis (total 6 hours).	
Bending Test	No mechanical damage	Bending Limit; 2mm Test Speed; 1.0mm/sec. Keep the test board at the limit point in 5 sec. PCB thickness : 1.6mm	
Terminal Adhesion Test	No indication of peeling shall occur on the terminal electrode.	W(kgf)	TIME(sec)
			0.5
Drop Test	No mechanical damage Inductance change to be within ±20% to the initial.	Random Free Fall test on concrete plate. 1 meter, 10 drops	

1. Model : CIGT201610UM1R0MNE

2. Description

Part no.	Size [inch/mm]	Thickness [mm] (max)	Inductance [uH]	Inductance tolerance (%)	DC Resistance [mΩ]		Rated DC Current (Isat) [A]		Rated DC Current (Irms) [A]	
					Max.	Typ.	Max.	Typ.	Max.	Typ.
CIGT201610UM1R0MNE	0806/2016	1.0	1.0	±20	57	48	3.1	3.45	2.8	3.1

* Inductance : Measured with a LCR meter 4991A(Agilent) or equivalent (Test Freq. 1MHz, Level 0.1V)

* DC Resistance : Measured with a Resistance HI-TESTER 3541(HIOKI) or equivalent

* Maximum allowable DC current : Value defined when DC current flows and the nominal value of inductance has decreased by 30% or when current flows and temperature has risen to 40°C whichever is smaller. (Reference: ambient temperature is 25°C±10)

(Isat) : Allowable current in DC saturation : The DC saturation allowable current value is specified when the decrease of the nominal inductance value at 30% (Reference: ambient temperature is 25°C±10)

(Irms) : Allowable current of temperature rise : The temperature rise allowable current value is specified when temperature of the inductor is raised 40°C by DC current. (Reference: ambient temperature is 25°C±10)

* Absolute maximum voltage : Rated Voltage 20V.

* Operating temperature range : -40 to +125°C (Including self-temperature rise)

3. Characteristics data

1) Frequency characteristics (Ls)

Agilent E4294A +E4991A , 1MHz to 1,000MHz

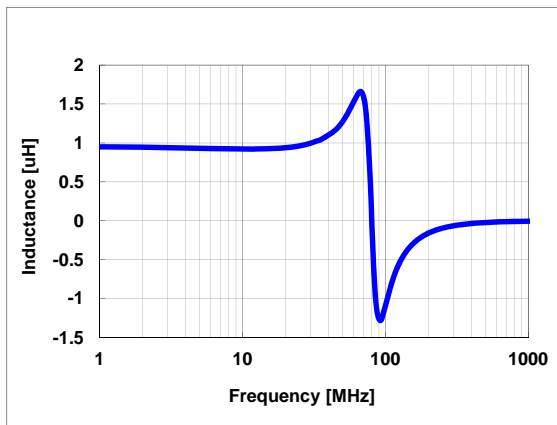

2) Frequency characteristics (Q)

Agilent E4294A +E4991A , 1MHz to 1,000MHz

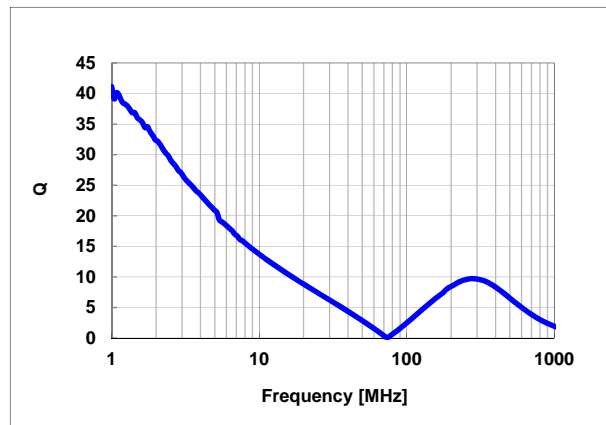

3) DC Bias characteristics (Typ.)

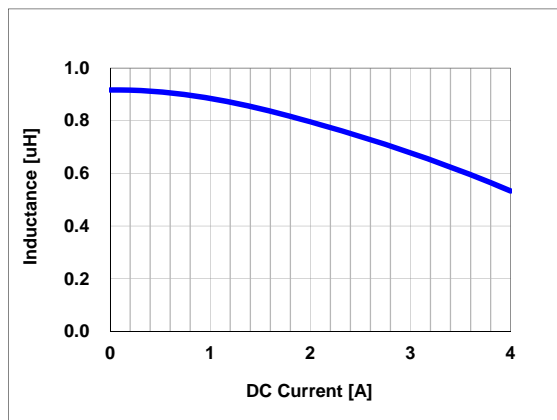

4) Temperature characteristics (Typ.)

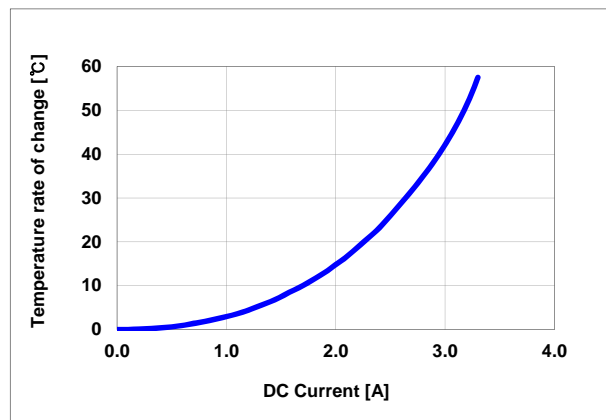

Any data in this sheet are subject to change, modify or discontinue without notice

The data sheets include the typical data for design reference only. If there is any question regarding the data sheets, please contact our sales personnel or application engineers

Caution of Application

Disclaimer

The products listed as follows are NOT designed and manufactured for any use and applications set forth below.

Please note that any misuse of the products deviating from products specifications or information provided in this Spec sheet may cause serious property damages or personal injury.

- ① Aerospace/Aviation equipment
- ② Automotive of Transportation equipment (vehicles , trains , ships , etc)
- ③ Military equipment
- ④ Atomic energy-related equipment
- ⑤ Undersea equipment
- ⑥ Any other applications with the same as or similar complexity or reliability to the applications

Limitation

Please contact us with usage environment information such as voltage, current, temperature, or other special conditions before using our products for the applications listed below.

The below application conditions require especially high reliability products to prevent defects that may directly cause damages or loss to third party's life, body or property.

If you have any questions regarding this 'Limitation' , you should first contact our sales personnel or application engineers.

- ① Medical equipment
- ② Disaster prevention/crime prevention equipment
- ③ Power plant control equipment
- ④ Traffic signal equipment
- ⑤ Data-processing equipment
- ⑥ Electric heating apparatus , burning equipment
- ⑦ Safety equipment
- ⑧ Any other applications with the same as or similar complexity or reliability to the applications

3. Packaging

This specification applies to taping of power inductor.

It can be possible to change the specification under document agreement between design engineers of each party.

3-1. Figure

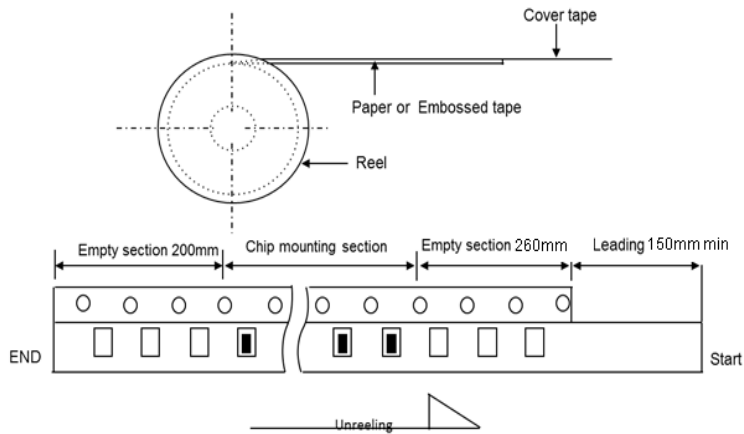

3-2. Reel Size

• Reel dimensions

Unit: mm

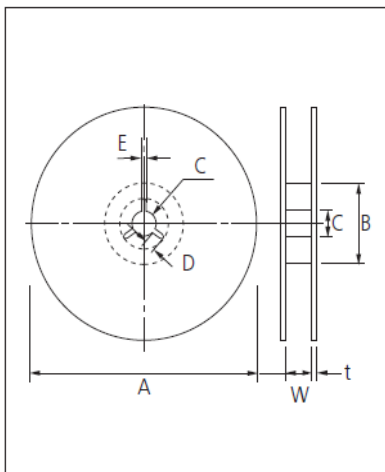

Symbol	Tape Width	A	B	C	D
7" Reel	8mm	180+0/-3	∅ 60+1/-0	∅ 13±0.3	4±0.2
	12mm	∅ 180+0/-3	∅ 60+1/-0	∅ 13±0.3	4±0.2
10" Reel	8mm	∅ 258+0/-3	∅ 80+1/-0	∅ 13±0.3	4±0.2
	12mm	∅ 258+0/-3	∅ 80+1/-0	∅ 13±0.3	4±0.2
13" Reel	8mm	∅ 330±2.0	∅ 80±1.0	∅ 13±0.3	4±0.2
	12mm	∅ 330±2.0	∅ 80±1.0	∅ 13±0.3	4±0.2

Symbol	Tape Width	E	W	t
7" Reel	8mm	2.0±0.5	9±0.5	1.2±0.2
	12mm	2.0±0.5	13±0.5	1.2±0.2
10" Reel	8mm	2.0±0.5	9±0.5	1.8±0.2
	12mm	2.0±0.5	13±0.5	1.8±0.2
13" Reel	8mm	2.0±0.5	9±0.5	2.2±0.2
	12mm	2.0±0.5	13±0.5	2.2±0.2

3-3. Tape Size & Quantity

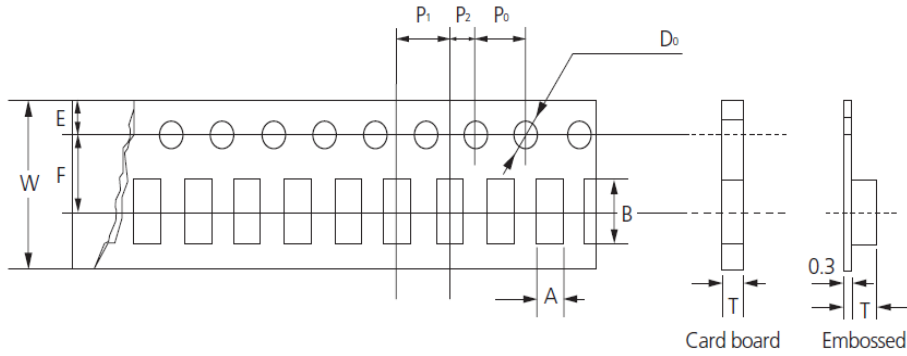

Unit: mm

Type	Tape	Chip Thickness	Chip Cavity		T	W	F	E	P ₁	P ₂	P ₀	D ₀	Quantity /Reel(PCS)
			A	B									
1210	Cardboard	0.55±0.1	1.25 ±0.05	1.45 ±0.05	0.58 ±0.03	8.00 ±0.10	3.50 ±0.05	1.75 ±0.05	4.00 ±0.10	2.00 ±0.05	4.00 ±0.10	1.55 ±0.05	4,000_7"
1608	Cardboard	0.7±0.1	1.15 ±0.05	2.00 ±0.05	0.95 ±0.05	8.00 ±0.10	3.5 ±0.05	1.75 ±0.05	4.0 ±0.1	2.0 ±0.05	4.0 ±0.1	Φ1.5 ±0.05	4,000_7"
1608	Cardboard	0.55±0.1	1.10 ±0.05	1.90 ±0.05	0.68 ±0.05	8.00 ±0.10	3.5 ±0.05	1.75 ±0.05	4.0 ±0.1	2.0 ±0.05	4.0 ±0.1	Φ1.5 ±0.05	4,000_7"
2012	Embossed	0.5±0.1	1.48 ±0.05	2.27 ±0.05	0.7 ±0.05	8.0 ±0.3/-0.1	3.5 ±0.05	1.75 ±0.1	4.0 ±0.1	2.0 ±0.05	4.0 ±0.1	Φ1.5 ±0.1/-0.0	3,000_7" 12,000_13"
2012	Embossed	0.7±0.1	1.48 ±0.05	2.27 ±0.05	0.9 ±0.1	8.0 ±0.3/-0.1	3.5 ±0.05	1.75 ±0.1	4.0 ±0.1	2.0 ±0.05	4.0 ±0.1	Φ1.5 ±0.1/-0.0	3,000_7" 12,000_13"
2012	Embossed	0.9±0.1	1.48 ±0.05	2.27 ±0.05	1.1 ±0.05	8.0 ±0.3/-0.1	3.5 ±0.05	1.75 ±0.1	4.0 ±0.1	2.0 ±0.05	4.0 ±0.1	Φ1.5 ±0.1/-0.0	3,000_7" 12,000_13"
2016	Embossed	0.55±0.1	1.9 ±0.05	2.25 ±0.05	0.75 ±0.05	8.0 ±0.1	3.5 ±0.05	1.75 ±0.1	4.0 ±0.1	2.0 ±0.05	4.0 ±0.1	Φ1.5 ±0.1/-0.0	3,000_7"
2019	Embossed	0.63 Max.	1.9 ±0.05	2.25 ±0.05	0.75 ±0.05	8.0 ±0.1	3.5 ±0.05	1.75 ±0.1	4.0 ±0.1	2.0 ±0.05	4.0 ±0.1	Φ1.5 ±0.1/-0.0	3,000_7"
2016	Embossed	0.7±0.1	1.88 ±0.1	2.23 ±0.1	0.9 ±0.1	8.0 ±0.1	3.5 ±0.05	1.75 ±0.1	4.0 ±0.1	2.0 ±0.05	4.0 ±0.1	Φ1.5 ±0.1/-0.0	3,000_7" 12,000_13"
2016	Embossed	0.9±0.1	1.83 ±0.1	2.23 ±0.1	1.1 ±0.1	8.0 ±0.3/-0.1	3.5 ±0.05	1.75 ±0.1	4.0 ±0.1	2.0 ±0.05	4.0 ±0.1	Φ1.5 ±0.1/-0.0	3,000_7" 12,000_13"
2016	Embossed	1.1±0.1	1.88 ±0.08	2.25 ±0.08	1.3 ±0.08	8.0 ±0.1	3.5 ±0.05	1.75 ±0.1	4.0 ±0.1	2.0 ±0.05	4.0 ±0.1	Φ1.5 ±0.1/-0.0	3,000_7" 12,000_13"
2520	Cardboard	0.6±0.1	2.55	2.85	0.75	8.0 ±0.1	3.5 ±0.05	1.75 ±0.1	4.0 ±0.1	2.0 ±0.05	4.0 ±0.1	Φ1.55 ±0.1/-0.0	3,000_7"
2520	Embossed	0.7±0.1	2.20 ±0.05	2.70 ±0.05	0.90 ±0.05	8.0 ±0.3/-0.1	3.5 ±0.05	1.75 ±0.1	4.0 ±0.1	2.0 ±0.05	4.0 ±0.1	Φ1.5 ±0.1/-0.0	3,000_7"
2520	Embossed	0.7±0.1	2.30 ±0.08	2.80 ±0.08	0.9 ±0.08	8.0 ±0.1	3.5 ±0.05	1.75 ±0.1	4.0 ±0.1	2.0 ±0.05	4.0 ±0.1	Φ1.5 ±0.1/-0.0	3,000_7" 10,000_13"
2520	Embossed	0.9±0.1	2.25 ±0.05	2.74 ±0.05	1.10 ±0.05	8.0 ±0.1	3.5 ±0.05	1.75 ±0.1	4.0 ±0.1	2.0 ±0.05	4.0 ±0.1	Φ1.5 ±0.1/-0.0	3,000_7"
2520	Embossed	0.9±0.1	2.30 ±0.08	2.80 ±0.08	1.10 ±0.08	8.0 ±0.1	3.5 ±0.05	1.75 ±0.1	4.0 ±0.1	2.0 ±0.05	4.0 ±0.1	Φ1.5 ±0.1/-0.0	3,000_7" 10,000_13"
2520	Embossed	1.2 max	2.30 ±0.08	2.80 ±0.08	1.30 ±0.08	8.0 ±0.1	3.5 ±0.05	1.75 ±0.1	4.0 ±0.1	2.0 ±0.05	4.0 ±0.1	Φ1.5 ±0.1/-0.0	2,500_7"
4040	Embossed	1.2 max	4.10 ±0.08	4.40 ±0.08	1.35 ±0.08	12.0 ±0.1	5.50 ±0.05	1.75 ±0.1	8.00 ±0.1	2.0 ±0.05	8.00 ±0.1	1.5 ±0.1/-0.0	4,000_13"
4040	Embossed	1.5 max	4.39 ±0.08	4.51 ±0.08	1.65 ±0.08	12.0 ±0.1	5.50 ±0.05	1.75 ±0.1	8.00 ±0.1	2.0 ±0.05	8.00 ±0.1	1.5 ±0.1/-0.0	4,000_13"
4040	Embossed	2.0 max	4.39 ±0.08	4.51 ±0.08	2.13 ±0.08	12.0 ±0.1	5.50 ±0.05	1.75 ±0.1	8.00 ±0.1	2.0 ±0.05	8.00 ±0.1	1.5 ±0.1/-0.0	4,000_13"

※ According to normal size, we fill out A, B in the table above. The data may be changed as special size tolerance.

3-4. Cover tape peel-off force

3-4-1. Peel-off force

10 g.f ≤ peel-off force ≤ 70 g.f

3-4-2. Measuring method

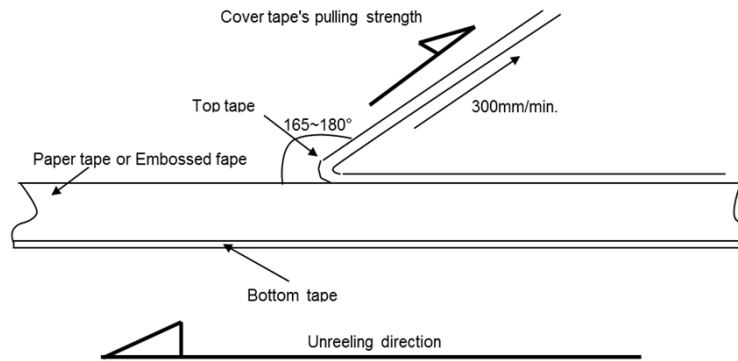

-Taping Packaging design : Packaging design follows IEC 60286-3 standard.

(IEC 60286-3 Packaging of components for automatic handling - parts 3)

* In case of problem due to static electricity of SMT process, contact us.

3-5. BOX package

3-5-1. Packaging Label

Reel and Box type

A label contains the product information below

- 1) Chip size and inductance
- 2) Part No.
- 3) LOT Number, Reel Number, Quantity
- 4) Bar Code (Lot No. and Quantity)



3-5-2. Box Packaging

- 1) Double packaging with paper type inner box and outer box.
- 2) Avoid any damage during transportation by car, airplane and ship.
- 3) Remark information of contents on inner box and outer box

※ In case special packaging is required, contact us.

3-5-3. 7" Box packaging

[Unit : mm]

- Inner Box (7" x 10 REEL)

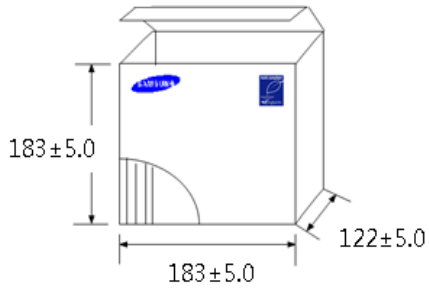

- Out Box (7" x 20 REEL)

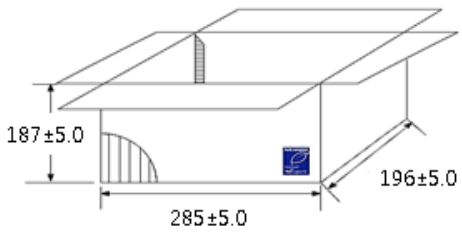

- Out Box (7" x 60 REEL)

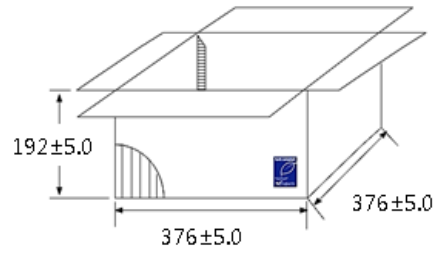

3-5-4. 13" Box packaging

- Inner Box (13" x 4 REEL)

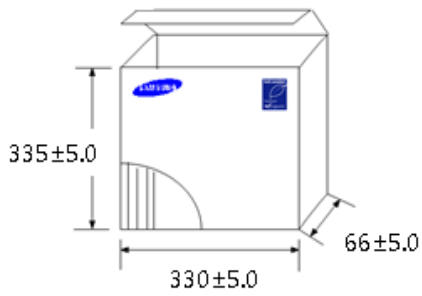

- Out Box (13" x 20 REEL)

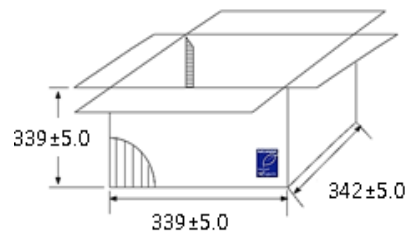

4. Product Characteristics data

4-1. Inductance

Measured with a LCR meter 4991A(Keysight) or the equivalent of the equipment type (Test Freq. 1MHz, Level 0.1V)

4-2. DC Resistance

Measured with a Resistance HI-TESTER 3541(HIOKI) or the equivalent of the equipment type

4-3. Isat (Saturation Current)

The allowable current value of the DC saturation is specified when the initial inductance value decreases by 30%.

(Reference: room temperature at 25°C±10)

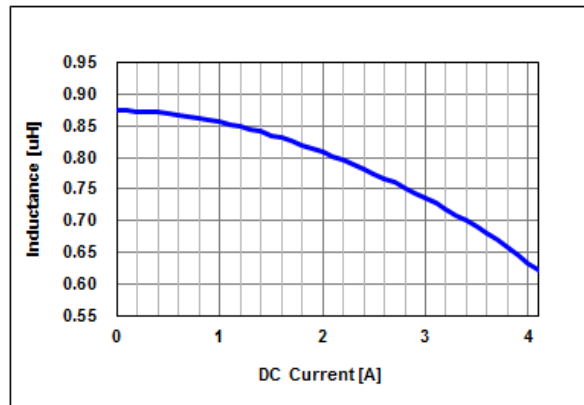

[Ex: Inductor Saturation Characteristics]

4-4. Itemp (Temperature Characteristics)

The allowable current value of the temperature rise is specified when temperature of the inductor increases by 40°C through DC current.

(Reference: room temperature at 25°C±10)

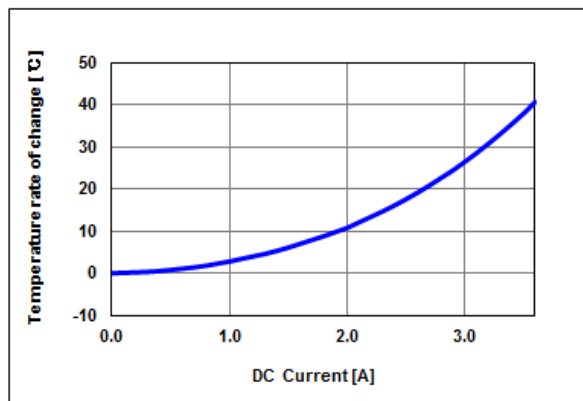

5. Electrical & Mechanical Caution

5-1. Operating instructions on current and voltage

Use caution for an inductor not to apply exceeded rated current or voltage.

- . Maximum current, such as DC current or DC + AC current, applied to an inductor should not exceed its rated current.
- . Applied current should be chosen at lower value between $I_{sat\ Max}$ and $I_{temp\ Max}$.
- . The max voltage, 0V as reference, applied to an inductor should be applied below the rated voltage of power inductor.
- . Abnormal voltage (e.g., Surge voltage, static electricity, etc.) should not exceed the rated voltage of power inductor.

[Types of current applied to the inductor]

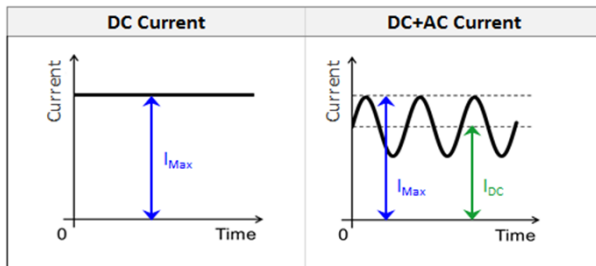

[Types of voltage applied to the inductor]

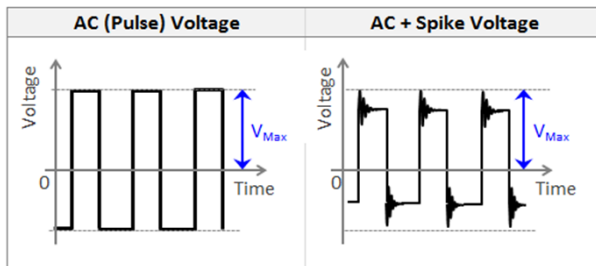

5-2. Vibration

It is required to check vibration, type of shock and generation of resonance.

Mounted power inductor not to generate resonance and avoid any kind of impact to terminals.

In case of environment under vibration condition, consider to use special power inductor.

5-3. Shock

Mechanical stress caused by dropping may cause damage of inductor body.

Do not use a dropped inductor to avoid any quality and reliability deterioration.

When piling up or handling printed circuit board, do not hit inductor with the corners of a printed circuit board to prevent the cracks or any other damages to the power inductor.

6. Process of Mounting and Soldering

6-1. Mounting

6-1-1. Mounting position

It is recommended to locate the major axis of power inductor in parallel to the direction in which the stress is applied.

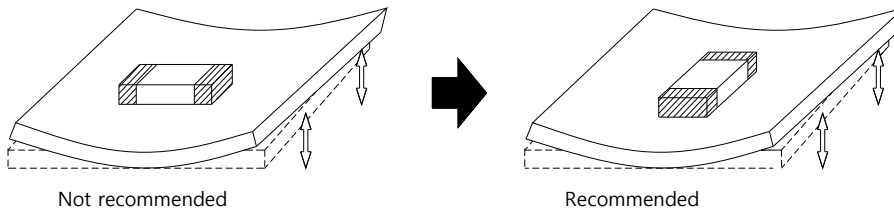

6-1-2. Cautions during mounting near the cutout

Please take the following measures to effectively reduce the stress generated from the cutting of PCB. Select the mounting location shown below, since the mechanical stress is affected by a location and a direction of power inductors mounted near the cutting line.

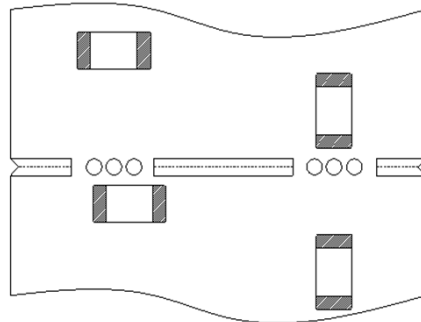

6-1-3. Cautions during mounting near screw

If power inductor is mounted near a screw hole, the board deflection may be occurred by screw torque.

Mount power inductors as far from the screw holes as possible.

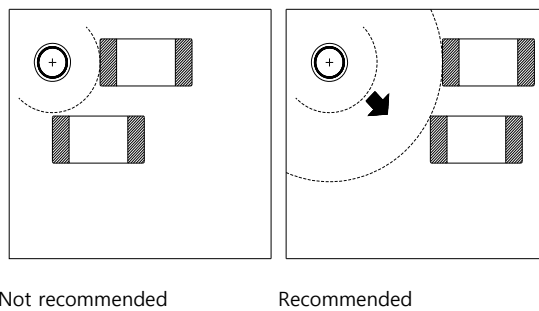

6-2. Caution before Mounting

- 6-2-1. It is recommended to store and use power inductor in a reel. Do not re-use power inductor that was isolated from the reel.
- 6-2-2. Check the inductance characteristics under actual applied current.
- 6-2-3. Check the mechanical stress when actual process and equipment is in use.
- 6-2-4. Check the rated current, rated voltage and other electrical characteristics before assembly.
Heat treatment must be done prior to measurement of inductance.
- 6-2-5. Check the solder-ability of power inductor that has passed shelf life before use.
- 6-2-6. The use of Sn-Zn based solder may deteriorate the reliability of power inductor.

6-3. Cautions during Mounting with Mounting (pick-and-place) Machines

6-3-1. Mounting Head Pressure

Excessive pressure may cause damages in power inductor.
It is recommended to adjust the nozzle pressure within the maximum value of 300g.f.
Additional conditions must be set for both thin film and special purpose power inductor.

6-3-2. Bending Stress

When using a two-sided substrate, it is required to mount power inductor on one side first before mounting on the other side due to the bending of the substrate caused by the mounting head.
Support the substrate as shown in the picture below when power inductor is mounted on the other side.
If the substrate is not supported, bending of the substrate may cause damages in power inductor.

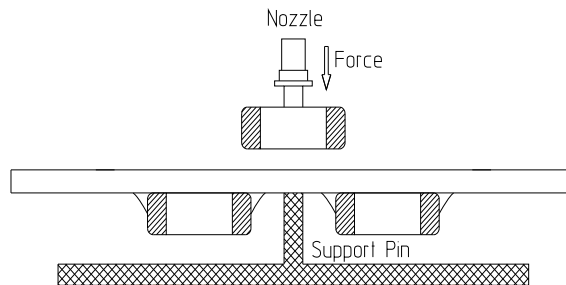

6-3-3. Suction nozzle

Dust accumulated in a suction nozzle and suction mechanism can impede a smooth movement of the nozzle.
This may cause damages in power inductor due to the excessive force during mounting.
If the mounting claw is worn out, it may cause damages in power inductor due to the uneven force during positioning.
A regular inspection such as maintenance, monitor and replacement for the suction nozzle and mounting claw should be conducted.

6-4. Reflow soldering

Power inductor is in a direct contact with the dissolved solder during soldering, which may be exposed to potential mechanical stress caused by the sudden temperature change. Therefore, power inductor may be contaminated by the location movement and flux. For the reason, the mounting process must be closely monitored.

Method		Classification
Reflow soldering	Overall heating	Infrared rays Hot plate VPS(Vapor phase)
	Local heating	Air heater Laser Light beam

6-4-1. Reflow Profile

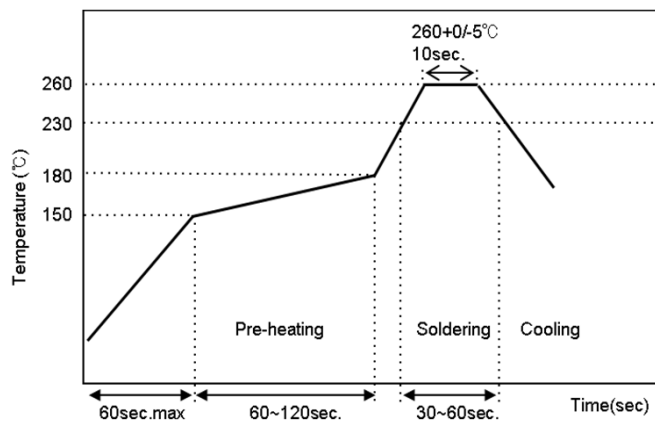

[Reflow Soldering Conditions]

Use caution not to exceed the peak temperature (260°C) and time (10sec) as shown. Pre-heating is necessary for all constituents including the PCB to prevent the mechanical damages on power inductor. The temperature difference between the PCB and the component surface must be kept to the minimum.

As for reflow soldering, it is recommended to keep the number of reflow soldering to less than three times. Please check with us when the number of reflow soldering needs to exceed three times. Care must be exercised especially for the ultra-small size, thin film and high inductance power inductor as they can be affected by thermal stress more easily.

6-4-2. Reflow temperature

The following quality problem may occur when power inductor is mounted with a lower temperature than the reflow temperature recommended by a solder manufacturer.

The specified peak temperature must be maintained after taking into consideration the factors such as the placement of peripheral constituent and the reflow temperature.

- Drop in solder wettability
- Solder voids
- Potential occurrence of whisker
- Drop in adhesive strength
- Drop in self-alignment properties
- Potential occurrence of tombstones

6-4-3. Cooling

Natural cooling with air is recommended.

6-4-4. Optimum solder flux for reflow soldering

- Overly the thick application of solder pastes results in an excessive solder fillet height. This makes power inductor more vulnerable to the mechanical and thermal stress from the board, which may cause damages in power inductor.
- Too little solder paste results in a lack of the adhesive strength, which may cause power inductor to isolate from PCB
- Check if solder has been applied uniformly after soldering is completed.

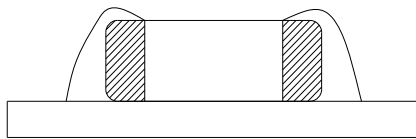

Too Much Solder
large stress may cause damages

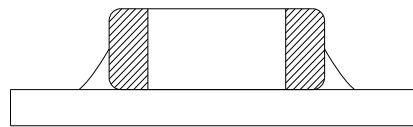

Not enough solder
Weak holding force may cause bad connections or detaching of the power inductor

- It is required to design a PCB with consideration of a solder land pattern and its size to apply an appropriate amount of solder to power inductor. The amount of the solder at the edge may impact directly on damages in power inductor.
- The design of a suitable solder land is necessary since the more the solder amount is, the larger the force power inductor experiences and the higher the chance power inductor damages.

6-5. Flow soldering

6-5-1. Flow profile

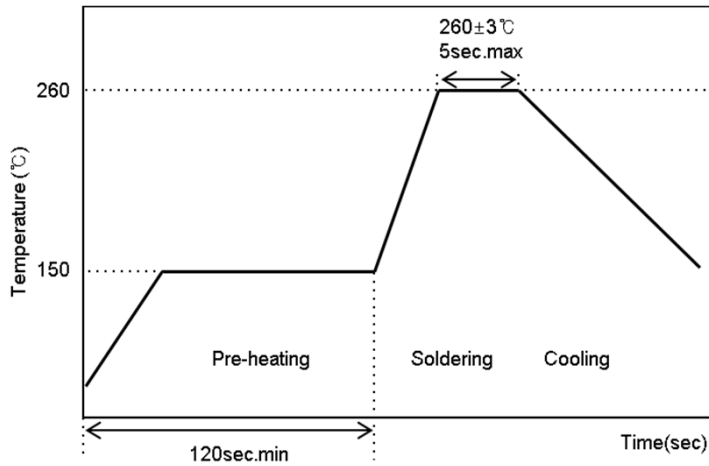

[Flow Soldering Conditions]

Take caution not to exceed peak temperature (260°C) and time (5sec) as shown.

6-5-2. Caution before Flow soldering

- When a sudden heat is applied to power inductor, the mechanical rigidity of power inductor is deteriorated by the internal deformation of power inductor.
Preheating all the constituents including PCB is required to prevent the mechanical damages on power inductor.
The temperature difference between the solder and the surface of power inductor must be kept to the minimum.
- If the flow time is too long or the flow temperature is too high, the adhesive strength with PCB may be deteriorated by the leaching phenomenon of the outer termination,
or the inductance value may be dropped by weak adhesion between the internal termination and the outer termination.

6-6. Soldering Iron

Manual soldering can pose a great risk on creating thermal damages in power inductor.

The high temperature soldering iron tip may come into a direct contact with the body of power inductor due to the carelessness of an operator.

Therefore, the soldering iron must be handled carefully, and close attention must be paid to the selection of the soldering iron tip and to temperature control of the tip.

6-6-1. How to use a soldering Iron

- In order to minimize damages on power inductor, preheating power inductor and PCB is necessary.
A hot plate and a hot air type preheater should be used for preheating
- Do not cool down power inductor and PCB rapidly after soldering.
- Keep the contact time between the outer termination of power inductor and the soldering iron as short as possible.
Long soldering time may cause problems such as adhesion deterioration by the leaching phenomenon of the outer termination.

Pre-heating Temp. (°C)	Soldering Temp.(°C)	Pre-heating Time(sec)	Soldering Time(sec)	Cooling Time(sec)
150	350 max	≥60	≤3	-

Condition of Iron facilities		
Wattage	Tip diameter	Soldering time
50W max	3 mm max	4sec max

* Caution

- Preheating at 150°C for 1 minute is required
- Iron tip should not contact with body directly
- Components can be damaged by excessive heat where soldering conditions exceed the specified range
- Lead-free solder: Sn-3.0Ag-0.5CU

6-6-2. How to use a spot heater

Compared to local heating using a solder iron, heat by a spot heater heats the overall power inductor and the PCB, which is likely to lessen the thermal shocks.

For a high density PCB, a spot heater can prevent the problem to connect between a solder iron and power inductor directly.

- If the distance from the air nozzle outlet to power inductor is too close, power inductor may be damaged due to the thermal stress.
Follow the conditions set in the table below to prevent this problem.
- The spot heater application angle as shown in the figure is recommended to create a suitable solder fillet shape.

Distance	5 mm ≤
Hot Air Application angle	45°C
Hot Air Temperature Nozzle Outlet	350°C ≥
Application Time	10s >

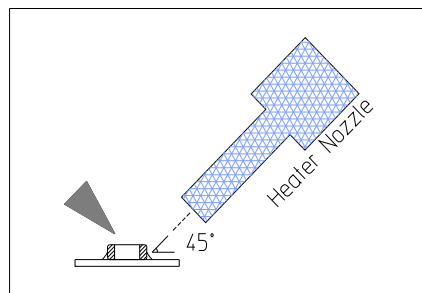

* Caution

- Preheating at 150°C for 1 minute is required
- Components can be damaged by excessive heat where soldering conditions exceed the specified range
- Lead-free solder: Sn-3.0Ag-0.5CU

6-6-3. Cautions for re-work

- Too much solder amount will increase the risk of PCB bending or cause other damages.
- Too little solder amount will result in power inductor breaking loose from the PCB due to the inadequate adhesive strength.
- Check if the solder has been applied properly and ensure the solder fillet has a proper shape.

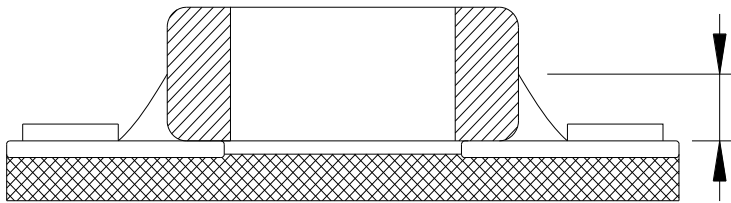

* Soldering wire below $\varnothing 0.5\text{mm}$ is required for soldering.

6-7. Cleaning

6-7-1. In general, cleaning is unnecessary if rosin flux is used.

When acidic flux is used strongly, chlorine in the flux may dissolve into some types of cleaning fluids, thereby affecting the performance of power inductor.

This means that the cleansing solution must be carefully selected and should always be new.

6-7-2. Cautions for cleaning

Power inductor or solder joint may be damaged with the vibration of PCB, if ultrasonic vibration is too strong during cleaning.

When high pressure cleaning equipment is used, test should be done for the cleaning equipment and its process before the cleaning in order to avoid damages on power inductor.

6-8. Cautions for using electrical measuring probes

- Confirm the position of the support pin or jig when checking the electrical performance of power inductor after mounting on the PCB.
- Watch for PCB bending caused by the pressure of a test-probe or other equipment.
- If the PCB is bent by the force from the test probe, power inductor may be damaged or the solder joint may be damaged.
- Avoid PCB flexing by using the support pin on the back side of the PCB.
- Place equipment with the support pin as close to the test-probe as possible.
- Prevent shock vibrations of the board when the test-probe contacts a PCB.

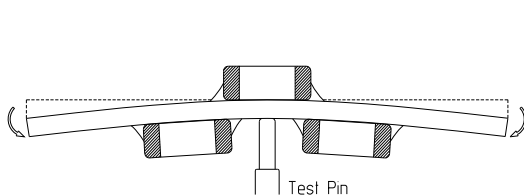

Not recommended

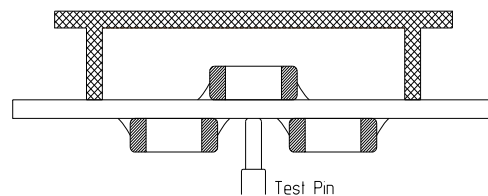

Recommended

6-9. Printed Circuit Board Cropping

- Do not apply any stress to power inductor such as bending or twisting the board after mounting power inductor on the PCB.
- The stress as shown may cause damages in power inductor when cutting the board.
- Damaged power inductor may cause degradation to the inductance.
- Avoid these types of stresses applied to power inductor.

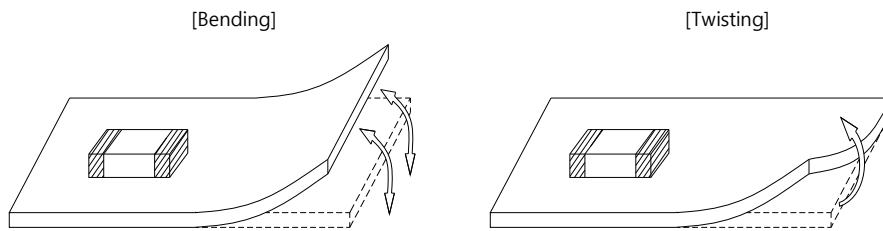

6-9-1. Cautions for cutting PCB

Check a cutting method of PCB in advance.

The high density board is separated into many individual boards after the completion of soldering.

If the board is bent or deformed during separation, power inductor may be damaged.

Carefully select a separation method that minimizes the deformation of the PCB.

6-10. Assembly Handling

6-10-1. Cautions for PCB handling

Hold the edges of the board mounted with power inductor with both hands since holding with one hand may bend the board.

Do not use dropped boards, which may degrade the quality of power inductor.

6-10-2. Mounting other components

Pay attention to the following conditions when mounting other components on the back side of the board after power inductor has been mounted on the front side.

When the suction nozzle is placed too close to the board, board deflection stress may be applied to power inductor on the back side, resulting in damages in power inductor.

Check if proper value is set on each chip mounter for a suction location, a mounting gap and a suction gap by the thickness of components.

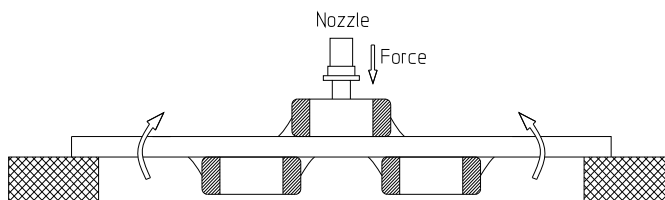

6-10-3. Board mounting with leads

If the board is bent when inserting components (transformer, IC, etc.) into it, power inductor or solder joint may be damaged.

Pay attention to the following:

- Reduce the stress on the board during insertion by increasing the size of the lead insertion hole.
- Insert components with leads into the board after fixing the board with support pins or a dedicated jig.
- Support the bottom side of the board to avoid bending the board.
- Check the status of the height of each support pin regularly when the support pins are used.

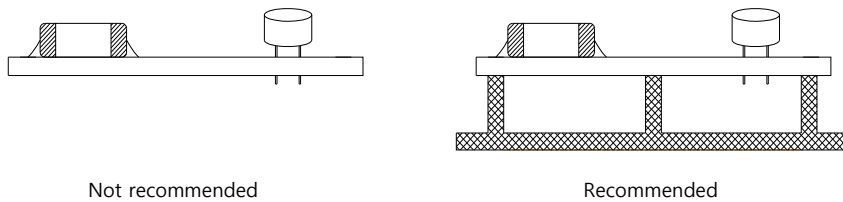

6-10-4. Socket and / or connector attach / detach

Since the insertion or removal from sockets and connectors may cause the board to bent, make sure that power inductor mounted on the board should not be damaged in this process.

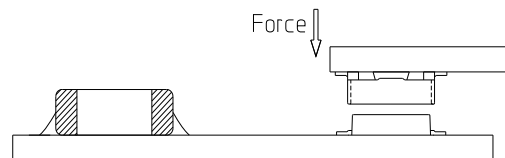

6-10-5. Fastening screw

When attaching a shield on a board, the board may be bent during a screw tightening work

Pay attention to the following conditions before performing the work.

- Plan the work to prevent the board from bending
- Use a torque driver to prevent over-tightening of the screw.
- Since the board may be bent by soldering, use caution in tightening the screw.

6-11. Adhesive selection

Pay attention to the following if an adhesive is used to position power inductor on the board before soldering.

6-11-1. Requirements for Adhesives

- They must have enough adhesive strength to prevent power inductor from slipping or moving during the handling the board.
- They must maintain their adhesive strength when exposed to soldering temperatures.
- They should not spread when applied to the PCB.
- They should have a long pot life.
- They should hardened quickly.
- They should not corrode the board or power inductor materials.
- They should be an insulator type that does not affect the characteristic of power inductor.
- They should be non-toxic, not harmful, and particularly safe when workers touch the adhesives.

6-11-2. Caution before Applying Adhesive

Check the correct application conditions before attaching power inductor to the board with an adhesive.

If the dimension of land, the type of adhesives, the amount of coating, the contact surface areas, the curing temperature, or other conditions are not appropriate, it may degrade the power inductor performance.

6-11-3. Cautions for selecting Adhesive

Depending on the type of the chosen adhesive, power inductor insulation resistance may be degraded.

In addition, power inductor may be damaged by the difference in contractile stress caused by the different contraction rate between power inductor and the adhesive.

6-11-4. Cautions for the amount of applied adhesive and curing temperature

· The inappropriate amount of the adhesive cause the weak adhesive strength, resulting in the a mounting defect in power inductor.

· Excessive use of the adhesive may cause a soldering defect, loss of electrical connection, incorrect curing, or slippage of a mounting position, thereby an inflow of the adhesive onto a land section should be avoided.

· If the curing temperature is too high or the curing time is too long, the adhesive strength will be degraded.

In addition, oxidation both on the outer termination (Sn) of power inductor and the surface of the board may deteriorate the solderability.

6-12. Flux

6-12-1. The excessive amount of flux generates excessive flux gases which may deteriorate solderability.

Therefore, apply the flux thin and evenly as a whole.

6-12-2. Flux with a high ratio of halogen may oxidize the outer termination of power inductor, if cleaning is not done properly.

Therefore, use flux with a halogen content of 0.1% max.

6-12-3. Strong acidic flux can degrade the power inductor performance.

6-12-4. Check the solder quality of power inductor and the amount of remaining flux surrounding power inductor after the mounting process.

6-13. Coating

6-13-1. Damage caused by Coating

A damage may be caused in the power inductor due to amount of the resin and stress of Thermal contraction of the resin during coating process.

During the coating process, the amount of resin and the stress of thermal contraction of the resin may cause damages in power inductor.

The difference of thermal expansion coefficient between the coating, or a molding resin may cause destruction, deterioration of inductance or dielectric breakdown of power inductor such as damages or detachment, etc.

6-13-2. Recommended Coating material

· A thermal expansion coefficient should be as close to that of power inductor as possible.

· A silicone resin can be used as an under-coating to buffer the stress.

· The resin should have a minimum curing contraction rate.

· The resin should have a minimum sensitivity (ex. Epoxy resin).

· The insulation resistance of power inductor can be deteriorated if a high hygroscopic property resin is used in a high humidity condition.

· Do not use strong acid substances due to the fact that coating materials inducing a family of halogen substances and organic acid may corrode power inductor.

7. Design

7-1. Circuit design

When the board is dropped or bent, power inductor mounted on the board may be short-circuited by the drop in insulation resistance. Therefore, it is required to install safety equipment such as a fuse to prevent additional accidents when power inductor is short-circuited, otherwise, electric short and fire may occur. This product is not a safety guaranteed product.

7-2. PCB Design

7-2-1. Unlike lead type components, SMD type components that are designed to be mounted directly on the board are fragile to the stress. In addition, they are more sensitive to mechanical and thermal stress than lead type components.

7-2-2. Power inductor damage by PCB material type

A great difference of the thermal expansion coefficient between PCB and power inductor causes thermal expansion and contraction, resulting in damages in power inductor.

Even though power inductor is mounted on a board with a fluorine resin or on a single-layered glass epoxy, damages in power inductor may occur.

7-3. Design system evaluation

7-3-1. Evaluate the actual design with power inductor to make sure there is no functional issue or violation of specifications of the finished goods.

7-3-2. Please note that the inductance may differ based on the operating condition of the actual system since Class 2 power inductor inductance varies with applied voltage and temperature.

7-3-3. Surge resistance must be evaluated since the excessive surge caused by the inductance of the actual system may apply to power inductor.

7-3-4. Note the actual power inductor size and the termination shape.

8. Others

8-1. Storage environment

8-1-1. Recommendation for temperature/humidity

Even taping and packaging materials are designed to endure a long-term storage, they should be stored with a temperature of 0~40°C and an RH of 0~70% otherwise, too high temperatures or humidity may deteriorate the quality of the product rapidly.

As oxidization is accelerated when relative humidity is above 70%RH, the lower the humidity is, the better the solderability is. As the temperature difference may cause dew condensation during the storage of the product, it is a must to maintain a temperature control environment

8-1-2. Shelf Life

An allowable storage period should be within 6 months from the outgoing date of delivery in consideration of solderability. As for products in storage over 6 months, please check solderability before use.

8-2. Caution for corrosive environment

As corrosive gases may deteriorate the solderability of power inductor outer termination, it is a must to store power inductor in an environment without gases.

Power inductor that is exposed to corrosive gases may cause its quality issues due to the corrosion of plating layers and the penetration of moisture.

8-3. Equipment in operation

8-3-1. Do not touch power inductor directly with bare hands to prevent an electric shock or damage.

8-3-2. The termination of power inductor shall not be contacted with a conductive object (short –circuit).
Do not expose power inductor to conductive liquid containing acidic or alkali material.

8-3-3. Do not use the equipment in the following conditions.

- (1) Exposure to water or oil
- (2) Exposure to direct sunlight
- (3) Exposure to Ozone or ultra-violet radiation.
- (4) Exposure to corrosive gas (e.g. hydrogen sulfide, sulfur dioxide, chlorine, ammonia gas)
- (5) Exposure to vibration or mechanical shock exceeding specified limit
- (6) Exposure to high humidity

8-3-4. If the equipment starts generating any smoke, fire or smell, immediately switch it off or unplug from the power source.
If the equipment is not switched off or unplugged, serious damage may occur due to the continuous power supply.
Please be careful with the high temperature in this condition.

8-4. Waste treatment

In case of scrapping power inductor, it is incinerated or buried by a licensed industrial waste company.

When scrapping power inductor, it is recommended to incinerate or bury the scrapping by a licensed industrial waste company.

8-5. Operating temperature

The operating temperature limit is determined by the specification of each models.

8-5-1. Do not use power inductor over the maximum operating temperature.

Pay attention to equipment's temperature distribution and the seasonal fluctuation of ambient temperature.

8-5-2. The surface temperature of power inductor cannot exceed the maximum operating temperature including self-heating effects.

8-6. Transportation

The performance of power inductor may be affected by transportation conditions.

8-6-1. power inductor shall be protected from excessive temperature, humidity and a mechanical force during transportation.

During transportation, the cartons shall not be deformed and the inner packaging shall be protected from excessive external forces.

8-6-2. Do not apply excessive vibrations, shocks or excessive forces to power inductor.

- If excessive mechanical shock or stress are applied, power inductor's body may damage.
- When the surface of power inductor is hit with the sharp edge of an air driver, a soldering iron, or a tweezer, etc, power inductor may damage or become open-circuited.

8-6-3. Power inductor may damage and become non-functional due to the excessive shocks or dropping during transportation.

8-7. Notice

Some special products are excluded from this document.

Please be advised that this is a standard product specification for a reference only.

We may change, modify or discontinue the product specifications without notice at any time.

So, you need to approve the product specifications before placing an order.

Should you have any question regarding the product specifications, please contact our sales personnel or application engineers.

单击下面可查看定价，库存，交付和生命周期等信息

[>>Samsung Electro-Mechanics\(三星电机\)](#)