

Middle Power LED Series  
2835

LM282B  
6V General



Designed for better lm/\$ (Lamps)



#### Features & Benefits

- 0.9W Class mid power LED
- Standard form factor for design flexibility (2.8 × 3.5 mm)



## Table of Contents

1.	Characteristics	-----	3
2.	Product Code Information	-----	5
3.	Typical Characteristics Graphs	-----	18
4.	Outline Drawing & Dimension	-----	21
5.	Reliability Test Items & Conditions	-----	22
6.	Soldering Conditions	-----	23
7.	Tape & Reel	-----	24
8.	Label Structure	-----	26
9.	Packing Structure	-----	27
10.	Precautions in Handling & Use	-----	30



## 1. Characteristics

### a) Absolute Maximum Rating

Item	Symbol	Rating	Unit	Condition
Ambient / Operating Temperature	Ta	-40 ~ +80	°C	-
Storage Temperature	Tstg	-40 ~ +80	°C	-
LED Junction Temperature	Tj	115	°C	-
Forward Current	IF	160	mA	-
Peak Pulsed Forward Current	I <sub>FP</sub>	320	mA	Duty 1/10, pulse width 10ms
Assembly Process Temperature	-	260 <10	°C s	-
ESD (HBM)	-	2	kV	-

#### Note:

Proper current derating must be observed to maintain junction temperature below the maximum at all time.

### b) Electro-optical Characteristics (I<sub>F</sub> = 150 mA, T<sub>s</sub> = 25 °C)

Item	Unit	Rank	Bin	Min.	Typ.	Max.
Forward Voltage (VF)	V	GB	G1	5.7	-	6.0
			G2	6.0	-	6.3
			G3	6.3	-	6.6
			G4	6.6	-	6.9
Color Rendering Index (Ra)	-	5		80	-	-
Thermal Resistance (junction to solder point)	°C/W			-	15	-
Beam Angle	°			-	120	-

#### Note:

Samsung maintains measurement tolerance of: forward voltage = ±0.3 V, CRI = ±3



**b) Electro-optical Characteristics** ( $I_F = 150 \text{ mA}$ ,  $T_s = 25 \text{ °C}$ )

Item	CRI ( $R_a$ ) Min.	Nominal CCT (K)	Bin	150mA		
				Min.	Max.	
Luminous Flux ( $\Phi_v$ )	80	2700	SA	S1	103	108
				S2	108	113
			SB	S3	113	118
				S4	118	123
		3000	SA	S1	105	110
				S2	110	115
			SB	S3	115	120
				S4	120	125
		3500	SA	S1	108	113
				S2	113	118
			SB	S3	118	123
				S4	123	128
		4000	SA	S1	110	115
				S2	115	120
			SB	S3	120	125
				S4	125	130
		5000	SA	S1	115	120
				S2	120	125
			SB	S3	125	130
				S4	130	135
		5700	SA	S1	113	118
				S2	118	123
			SB	S3	123	128
				S4	128	133
6500	SA	S1	110	115		
		S2	115	120		
	SB	S3	120	125		
		S4	125	130		

**Note:**

Samsung maintains measurement tolerance of: forward voltage =  $\pm 0.3\text{V}$ , luminous flux =  $\pm 5\%$ , CRI =  $\pm 3$



## 2. Product Code Information

1	2	3	4	5	6	7	8	9	10	11	12	13	14	15	16	17	18
S	P	M	W	H	1	2	2	1	F	D	5	G	B	R	0	S	0

Digit	PKG Information	Code	Specification
1 2 3	Samsung Package Middle Power	SPM	
4 5	Color	WH	White
6	Product Version	1	
7 8 9	Form Factor	221	2.8 x 3.5 x 0.65 mm; 2 pads; 2chip;
10	Sorting Current (mA)	F	150 mA
11	Chromaticity Coordinates	D	ANSI Standard
12	CRI	5	Min. 80
13 14	Forward Voltage (V)	GB	5.7~6.9 G1 5.7 ~ 6.0 G2 6.0 ~ 6.3 G3 6.3 ~ 6.6 G4 6.6 ~ 6.9
15 16	CCT (K)	W☆ V☆ U☆ T☆ R☆ Q☆ P☆	2700 W1, W2, W3, W4, W5, W6, W7, W8, W9, WA, WB, WC, WD, WE, WF, WG 3000 V1, V2, V3, V4, V5, V6, V7, V8, V9, VA, VB, VC, VD, VE, VF, VG 3500 U1, U2, U3, U4, U5, U6, U7, U8, U9, UA, UB, UC, UD, UE, UF, UG 4000 Bin Code: T1, T2, T3, T4, T5, T6, T7, T8, T9, TA, TB, TC, TD, TE, TF, TG 5000 R1, R2, R3, R4, R5, R6, R7, R8, R9,RA,RB,RC,RD,RE,RF,RG 5700 Q1, Q2, Q3, Q4, Q5, Q6, Q7, Q8, Q9,QA,QB,QC,QD,QE,QF,QG 6500 P1, P2, P3, P4, P5, P6, P7, P8, P9,PA,PB,PC,PD,PE,PF,PG ☆ : "0" (Whole bin) "M" (Quarter bin) or "K" (kitting bin)
17 18	Luminous Flux	SA SB	Bin Code: S1, S2 S3, S4



a) Luminous Flux Bins ( $I_f = 150 \text{ mA}$ ,  $T_s = 25^\circ\text{C}$ )

CRI ( $R_a$ ) Min.	Nominal CCT (K)	Product Code	Flux Bin	Flux Range ( $\Phi_v$ , lm)
80	2700	SPMWH1221FD5GBW☆SA	S1	103 ~ 108
			S2	108 ~ 113
		SPMWH1221FD5GBW☆SB	S3	113 ~ 118
			S4	118 ~ 123
	3000	SPMWH1221FD5GBV☆SA	S1	105 ~ 110
			S2	110 ~ 115
		SPMWH1221FD5GBV☆SB	S3	115 ~ 120
			S4	120 ~ 125
	3500	SPMWH1221FD5GBU☆SA	S1	108 ~ 113
			S2	113 ~ 118
		SPMWH1221FD5GBU☆SB	S3	118 ~ 123
			S4	123 ~ 128
	4000	SPMWH1221FD5GBT☆SA	S1	110 ~ 115
			S2	115 ~ 120
		SPMWH1221FD5GBT☆SB	S3	120 ~ 125
			S4	125 ~ 130
	5000	SPMWH1221FD5GBR☆SA	S1	115 ~ 120
			S2	120 ~ 125
		SPMWH1221FD5GBR☆SB	S3	125 ~ 130
			S4	130 ~ 135
	5700	SPMWH1221FD5GBQ☆SA	S1	113 ~ 118
			S2	118 ~ 123
		SPMWH1221FD5GBQ☆SB	S3	123 ~ 128
			S4	128 ~ 133
6500	SPMWH1221FD5GBP☆SA	S1	110 ~ 115	
		S2	115 ~ 120	
	SPMWH1221FD5GBP☆SB	S3	120 ~ 125	
		S4	125 ~ 130	

**Note:** ☆" can be "0" (Whole bin), "M" (Quarter bin) or "K" (Kitting bin) of the color binning



## b) Kitting rule

### 1) Kitting bin Concept

1. Under agreement between customer and SAMSUNG ELECTRONICS, SAMSUNG can supply kitting bin (VF, Color, Im).
2. A forward voltage (VF) of kitting bin is combined by a pair of same VF rank such as (A3+A3), (A4+A4) or (A5+A5).
3. A Chromaticity Coordinates of kitting bin is mixed by kitting procedure.(below kitting simulation)

#### [Kitting example]

D Y	E	F	Z G
9	A	B	C
5	6	7	8
W 1	2	3	X 4

#### [Binning Information]

	Bin #1	Bin #2
VF	A2	A2
	A3	A3
	A4	A4
	A5	A5
CIE	W (1, 2, 5, 6 bin)	Z (B, C, F, G bin)
	V (6, 7, A, B bin)	V (6, 7, A, B bin)
	X (3, 4, 7, 8 bin)	Y (9, A, D, E bin)

※ Each of V, W, X, Y and Z can be one bin without details division

**c) Color Bins ( $I_F = 150 \text{ mA}$ ,  $T_s = 25 \text{ }^\circ\text{C}$ )**

CRI ( $R_a$ ) Min.	Nominal CCT (K)	Product Code	Color Rank	Chromaticity Bins
80	2700	SPMWH1221FD5GBW0S★	W0 (Whole bin)	W1, W2, W3, W4, W5, W6, W7, W8, W9, WA, WB, WC, WD, WE, WF, WG
		SPMWH1221FD5GBWMS★	WM (Quarter bin)	W6, W7, WA, WB
		SPMWH1221FD5GBWKS★	WK (Kitting bin)	WV, WW, WX, WY, WZ
3000	3000	SPMWH1221FD5GBV0S★	V0 (Whole bin)	V1, V2, V3, V4, V5, V6, V7, V8, V9, VA, VB, VC, VD, VE, VF, VG
		SPMWH1221FD5GBVMS★	VM (Quarter bin)	V6, V7, VA, VB
		SPMWH1221FD5GBVKS★	VK (Kitting bin)	VV, VW, VX, VY, VZ
3500	3500	SPMWH1221FD5GBU0S★	U0 (Whole bin)	U1, U2, U3, U4, U5, U6, U7, U8, U9, UA, UB, UC, UD, UE, UF, UG
		SPMWH1221FD5GBUMS★	UM (Quarter bin)	U6, U7, UA, UB
		SPMWH1221FD5GBUKS★	UK (Kitting bin)	UV, UW, UX, UY, UZ
4000	4000	SPMWH1221FD5GBT0S★	T0 (Whole bin)	T1, T2, T3, T4, T5, T6, T7, T8, T9, TA, TB, TC, TD, TE, TF, TG
		SPMWH1221FD5GBTMS★	TM (Quarter bin)	T6, T7, TA, TB
		SPMWH1221FD5GBTKS★	TK (Kitting bin)	TV, TW, TX, TY, TZ
5000	5000	SPMWH1221FD5GBR0S★	R0 (Whole bin)	R1, R2, R3, R4, R5, R6, R7, R8, R9, RA, RB, RC, RD, RE, RF, RG
		SPMWH1221FD5GBRMS★	RM (Quarter bin)	R6, R7, RA, RB
		SPMWH1221FD5GBRKS★	RK (Kitting bin)	RV, RW, RX, RY, RZ
5700	5700	SPMWH1221FD5GBQ0S★	Q0 (Whole bin)	Q1, Q2, Q3, Q4, Q5, Q6, Q7, Q8, Q9, QA, QB, QC, QD, QE, QF, QG
		SPMWH1221FD5GBQMS★	QM (Quarter bin)	Q6, Q7, QA, QB
		SPMWH1221FD5GBQKS★	QK (Kitting bin)	QV, QW, QX, QY, QZ
6500	6500	SPMWH1221FD5GBP0S★	P0 (Whole bin)	P1, P2, P3, P4, P5, P6, P7, P8, P9, PA, PB, PC, PD, PE, PF, PG
		SPMWH1221FD5GBPMS0★	PM (Quarter bin)	P6, P7, PA, PB
		SPMWH1221FD5GBPKS★	PK (Kitting bin)	PV, PW, PX, PY, PZ

**Note:** "★" can be "A" or "B" of the flux binning





d) Voltage Bins ( $I_F = 150 \text{ mA}$ ,  $T_s = 25 \text{ }^\circ\text{C}$ )

CRI ( $R_a$ ) Min.	Nominal CCT (K)	Product Code	Voltage Rank	Voltage Bin	Voltage Range (V)
-	-	-	GB	G1	5.7 ~ 6.0
				G2	6.0 ~ 6.3
				G3	6.3 ~ 6.6
				G4	6.6 ~ 6.9



e) Chromaticity Region & Coordinates ( $I_F = 150 \text{ mA}$ ,  $T_s = 25 \text{ }^\circ\text{C}$ )

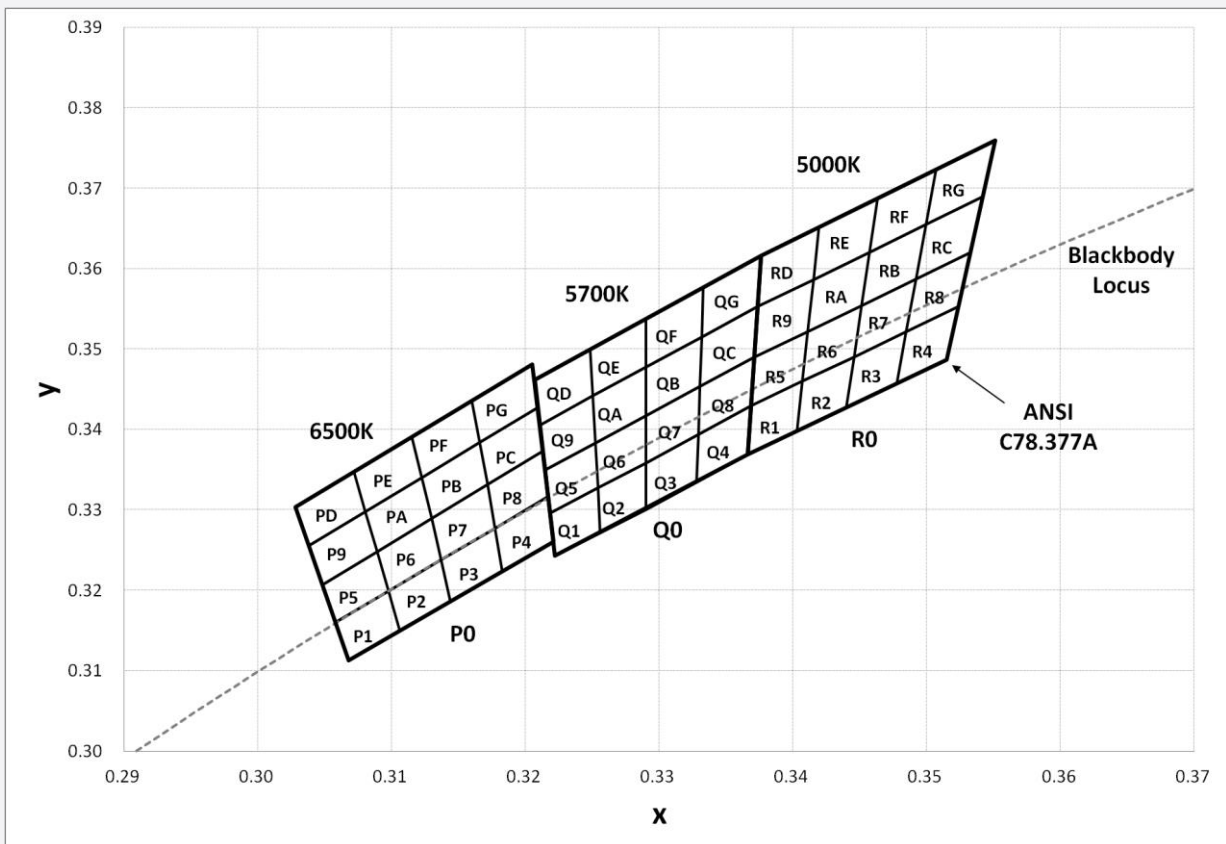
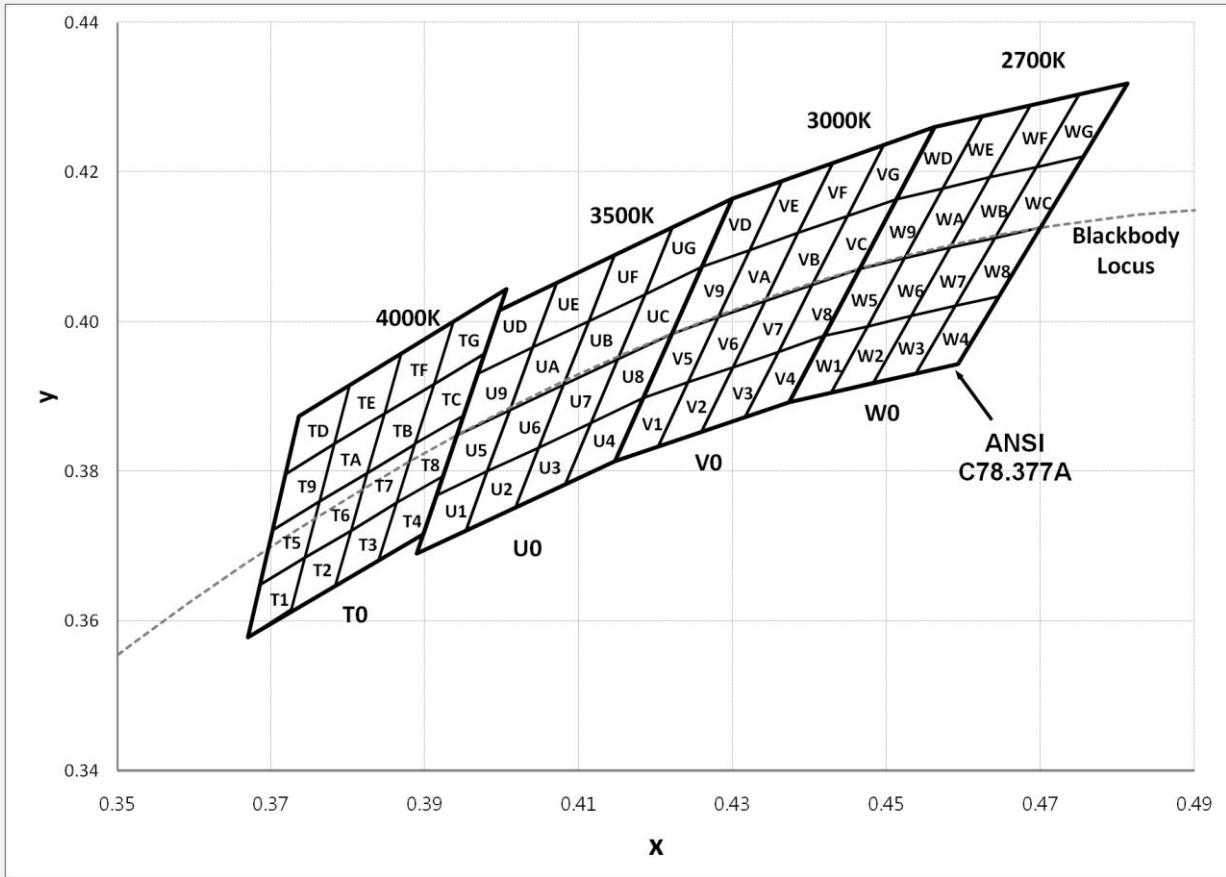

## e) Chromaticity Region &amp; Coordinates

Region	CIE x	CIE y	Region	CIE x	CIE y
<b>W rank (2700 K)</b>					
W1	0.4373	0.3893	W9	0.4465	0.4071
	0.4418	0.3981		0.4513	0.4164
	0.4475	0.3994		0.4573	0.4178
	0.4428	0.3906		0.4523	0.4085
W2	0.4428	0.3906	WA	0.4523	0.4085
	0.4475	0.3994		0.4573	0.4178
	0.4532	0.4008		0.4634	0.4193
W3	0.4483	0.3919	WB	0.4582	0.4099
	0.4532	0.4008		0.4634	0.4193
	0.4589	0.4021		0.4695	0.4207
	0.4538	0.3931		0.4641	0.4112
W4	0.4538	0.3931	WC	0.4641	0.4112
	0.4589	0.4021		0.4695	0.4207
	0.4646	0.4034		0.4756	0.4221
	0.4593	0.3944		0.4700	0.4126
W5	0.4418	0.3981	WD	0.4513	0.4164
	0.4465	0.4071		0.4562	0.4260
	0.4523	0.4085		0.4624	0.4274
	0.4475	0.3994		0.4573	0.4178
W6	0.4475	0.3994	WE	0.4573	0.4178
	0.4523	0.4085		0.4624	0.4274
	0.4582	0.4099		0.4687	0.4289
	0.4532	0.4008		0.4634	0.4193
W7	0.4532	0.4008	WF	0.4634	0.4193
	0.4582	0.4099		0.4687	0.4289
	0.4641	0.4112		0.4750	0.4304
	0.4589	0.4021		0.4695	0.4207
W8	0.4589	0.4021	WG	0.4695	0.4207
	0.4641	0.4112		0.4750	0.4304
	0.4700	0.4126		0.4813	0.4319
	0.4646	0.4034		0.4756	0.4221

Region	CIE x	CIE y	Region	CIE x	CIE y
<b>V rank (3000 K)</b>					
V1	0.4147	0.3814	V9	0.4221	0.3984
	0.4183	0.3898		0.4259	0.4073
	0.4242	0.3919		0.4322	0.4096
	0.4203	0.3833		0.4281	0.4006
V2	0.4203	0.3833	VA	0.4281	0.4006
	0.4242	0.3919		0.4322	0.4096
	0.4300	0.3939		0.4385	0.4119
V3	0.4259	0.3853	VB	0.4342	0.4028
	0.4300	0.3939		0.4385	0.4119
	0.4359	0.3960		0.4449	0.4141
	0.4316	0.3873		0.4403	0.4049
V4	0.4316	0.3873	VC	0.4403	0.4049
	0.4359	0.3960		0.4449	0.4141
	0.4418	0.3981		0.4513	0.4164
	0.4373	0.3893		0.4465	0.4071
V5	0.4183	0.3898	VD	0.4259	0.4073
	0.4221	0.3984		0.4299	0.4165
	0.4281	0.4006		0.4364	0.4188
	0.4242	0.3919		0.4322	0.4096
V6	0.4242	0.3919	VE	0.4322	0.4096
	0.4281	0.4006		0.4364	0.4188
	0.4342	0.4028		0.4430	0.4212
	0.4300	0.3939		0.4385	0.4119
V7	0.4300	0.3939	VF	0.4385	0.4119
	0.4342	0.4028		0.4430	0.4212
	0.4403	0.4049		0.4496	0.4236
	0.4359	0.3960		0.4449	0.4141
V8	0.4359	0.3960	VG	0.4449	0.4141
	0.4403	0.4049		0.4496	0.4236
	0.4465	0.4071		0.4562	0.4260
	0.4418	0.3981		0.4513	0.4164

## e) Chromaticity Region &amp; Coordinates

Region	CIE x	CIE y	Region	CIE x	CIE y
<b>U rank (3500 K)</b>					
U1	0.3889	0.3690	U9	0.3941	0.3848
	0.3915	0.3768		0.3968	0.3930
	0.3981	0.3800		0.4040	0.3966
	0.3953	0.3720		0.4010	0.3882
U2	0.3953	0.3720	UA	0.4010	0.3882
	0.3981	0.3800		0.4040	0.3966
	0.4048	0.3832		0.4113	0.4001
	0.4017	0.3751		0.4080	0.3916
U3	0.4017	0.3751	UB	0.4080	0.3916
	0.4048	0.3832		0.4113	0.4001
	0.4116	0.3865		0.4186	0.4037
	0.4082	0.3782		0.4150	0.3950
U4	0.4082	0.3782	UC	0.4150	0.3950
	0.4116	0.3865		0.4186	0.4037
	0.4183	0.3898		0.4259	0.4073
	0.4147	0.3814		0.4221	0.3984
U5	0.3915	0.3768	UD	0.3968	0.3930
	0.3941	0.3848		0.3996	0.4015
	0.4010	0.3882		0.4071	0.4052
	0.3981	0.3800		0.4040	0.3966
U6	0.3981	0.3800	UE	0.4040	0.3966
	0.4010	0.3882		0.4071	0.4052
	0.4080	0.3916		0.4146	0.4089
	0.4048	0.3832		0.4113	0.4001
U7	0.4048	0.3832	UF	0.4113	0.4001
	0.4080	0.3916		0.4146	0.4089
	0.4150	0.3950		0.4222	0.4127
	0.4116	0.3865		0.4186	0.4037
U8	0.4116	0.3865	UG	0.4186	0.4037
	0.4150	0.3950		0.4222	0.4127
	0.4221	0.3984		0.4299	0.4165
	0.4183	0.3898		0.4259	0.4073

Region	CIE x	CIE y	Region	CIE x	CIE y
<b>T rank (4000 K)</b>					
T1	0.3670	0.3578	T9	0.3702	0.3722
	0.3726	0.3612		0.3763	0.3760
	0.3744	0.3685		0.3782	0.3837
	0.3686	0.3649		0.3719	0.3797
T2	0.3726	0.3612	TA	0.3763	0.3760
	0.3783	0.3646		0.3825	0.3798
	0.3804	0.3721		0.3847	0.3877
	0.3744	0.3685		0.3782	0.3837
T3	0.3783	0.3646	TB	0.3825	0.3798
	0.3840	0.3681		0.3887	0.3836
	0.3863	0.3758		0.3912	0.3917
	0.3804	0.3721		0.3847	0.3877
T4	0.3840	0.3681	TC	0.3887	0.3837
	0.3898	0.3716		0.3950	0.3875
	0.3924	0.3794		0.3978	0.3958
	0.3863	0.3758		0.3912	0.3917
T5	0.3686	0.3649	TD	0.3719	0.3797
	0.3744	0.3685		0.3782	0.3837
	0.3763	0.3760		0.3802	0.3916
	0.3702	0.3722		0.3736	0.3874
T6	0.3744	0.3685	TE	0.3782	0.3837
	0.3804	0.3721		0.3847	0.3877
	0.3825	0.3798		0.3869	0.3958
	0.3763	0.376		0.3802	0.3916
T7	0.3804	0.3721	TF	0.3847	0.3877
	0.3863	0.3758		0.3912	0.3917
	0.3887	0.3836		0.3937	0.4001
	0.3825	0.3798		0.3869	0.3958
T8	0.3863	0.3758	TG	0.3912	0.3917
	0.3924	0.3794		0.3978	0.3958
	0.3950	0.3875		0.4006	0.4044
	0.3887	0.3836		0.3937	0.4001

## e) Chromaticity Region &amp; Coordinates

Region	CIE x	CIE y	Region	CIE x	CIE y
<b>R rank (5000 K)</b>					
R1	0.3366	0.3369	R9	0.3371	0.3490
	0.3369	0.3430		0.3374	0.3553
	0.3407	0.3460		0.3415	0.3587
	0.3403	0.3398		0.3411	0.3522
R2	0.3403	0.3398	RA	0.3411	0.3522
	0.3407	0.3460		0.3415	0.3587
	0.3446	0.3491		0.3457	0.3621
	0.3440	0.3427		0.3451	0.3554
R3	0.3440	0.3427	RB	0.3451	0.3554
	0.3446	0.3491		0.3457	0.3621
	0.3485	0.3522		0.3500	0.3655
	0.3478	0.3457		0.3492	0.3587
R4	0.3478	0.3457	RC	0.3492	0.3587
	0.3485	0.3522		0.3500	0.3655
	0.3524	0.3554		0.3542	0.3690
	0.3515	0.3487		0.3533	0.3620
R5	0.3369	0.3430	RD	0.3374	0.3553
	0.3371	0.3490		0.3376	0.3616
	0.3411	0.3522		0.3420	0.3652
	0.3407	0.3460		0.3415	0.3587
R6	0.3407	0.3460	RE	0.3415	0.3587
	0.3411	0.3522		0.3420	0.3652
	0.3451	0.3554		0.3463	0.3687
	0.3446	0.3491		0.3457	0.3621
R7	0.3446	0.3491	RF	0.3457	0.3621
	0.3451	0.3554		0.3463	0.3687
	0.3492	0.3587		0.3507	0.3724
	0.3485	0.3522		0.3500	0.3655
R8	0.3485	0.3522	RG	0.3500	0.3655
	0.3492	0.3587		0.3507	0.3724
	0.3533	0.3620		0.3551	0.3760
	0.3524	0.3554		0.3542	0.3690

Region	CIE x	CIE y	Region	CIE x	CIE y
<b>Q rank (5700 K)</b>					
Q1	0.3222	0.3243	Q9	0.3215	0.3350
	0.3219	0.3297		0.3211	0.3406
	0.3254	0.3328		0.3251	0.3442
	0.3256	0.3272		0.3253	0.3384
Q2	0.3256	0.3272	QA	0.3253	0.3384
	0.3254	0.3328		0.3251	0.3442
	0.3290	0.3359		0.3290	0.3478
	0.3290	0.3300		0.3290	0.3417
Q3	0.3290	0.3300	QB	0.3290	0.3417
	0.3290	0.3359		0.3290	0.3478
	0.3329	0.3394		0.3332	0.3515
	0.3328	0.3335		0.3331	0.3454
Q4	0.3328	0.3335	QC	0.3331	0.3454
	0.3329	0.3394		0.3332	0.3515
	0.3369	0.3430		0.3374	0.3553
	0.3366	0.3369		0.3371	0.3490
Q5	0.3219	0.3297	QD	0.3211	0.3406
	0.3215	0.3350		0.3207	0.3462
	0.3253	0.3384		0.3249	0.3500
	0.3254	0.3328		0.3251	0.3442
Q6	0.3254	0.3328	QE	0.3251	0.3442
	0.3253	0.3384		0.3249	0.3500
	0.3290	0.3417		0.3290	0.3538
	0.3290	0.3359		0.3290	0.3478
Q7	0.3290	0.3359	QF	0.3290	0.3478
	0.3290	0.3417		0.3290	0.3538
	0.3331	0.3454		0.3333	0.3577
	0.3329	0.3394		0.3332	0.3515
Q8	0.3329	0.3394	QG	0.3332	0.3515
	0.3331	0.3454		0.3333	0.3577
	0.3371	0.3490		0.3376	0.3616
	0.3369	0.3430		0.3374	0.3553

## e) Chromaticity Region &amp; Coordinates

Region	CIE x	CIE y	Region	CIE x	CIE y
<b>P rank (6500 K)</b>					
P1	0.3068	0.3113	P9	0.3048	0.3207
	0.3106	0.3150		0.3089	0.3249
	0.3098	0.3199		0.3080	0.3298
	0.3058	0.3160		0.3038	0.3256
P2	0.3106	0.3150	PA	0.3089	0.3249
	0.3144	0.3186		0.3130	0.3290
	0.3137	0.3238		0.3123	0.3341
	0.3098	0.3199		0.3080	0.3298
P3	0.3144	0.3186	PB	0.3130	0.3290
	0.3183	0.3224		0.3172	0.3332
	0.3177	0.3278		0.3166	0.3384
	0.3137	0.3238		0.3123	0.3341
P4	0.3183	0.3224	PC	0.3172	0.3332
	0.3221	0.3261		0.3213	0.3373
	0.3217	0.3317		0.3209	0.3427
	0.3177	0.3278		0.3166	0.3384
P5	0.3058	0.3160	PD	0.3038	0.3256
	0.3098	0.3199		0.3080	0.3298
	0.3089	0.3249		0.3072	0.3348
	0.3048	0.3207		0.3028	0.3304
P6	0.3098	0.3199	PE	0.3080	0.3298
	0.3137	0.3238		0.3123	0.3341
	0.3130	0.3290		0.3115	0.3391
	0.3089	0.3249		0.3072	0.3348
P7	0.3137	0.3238	PF	0.3123	0.3341
	0.3177	0.3278		0.3166	0.3384
	0.3172	0.3332		0.3160	0.3436
	0.3130	0.3290		0.3115	0.3391
P8	0.3177	0.3278	PG	0.3166	0.3384
	0.3217	0.3317		0.3209	0.3427
	0.3213	0.3373		0.3205	0.3481
	0.3172	0.3332		0.3160	0.3436

**Note:** Samsung maintains measurement tolerance of:  $C_x, C_y = \pm 0.005$



f) Kitting Chromaticity Region & Coordinates ( $I_F = 150 \text{ mA}$ ,  $T_s = 25^\circ\text{C}$ )

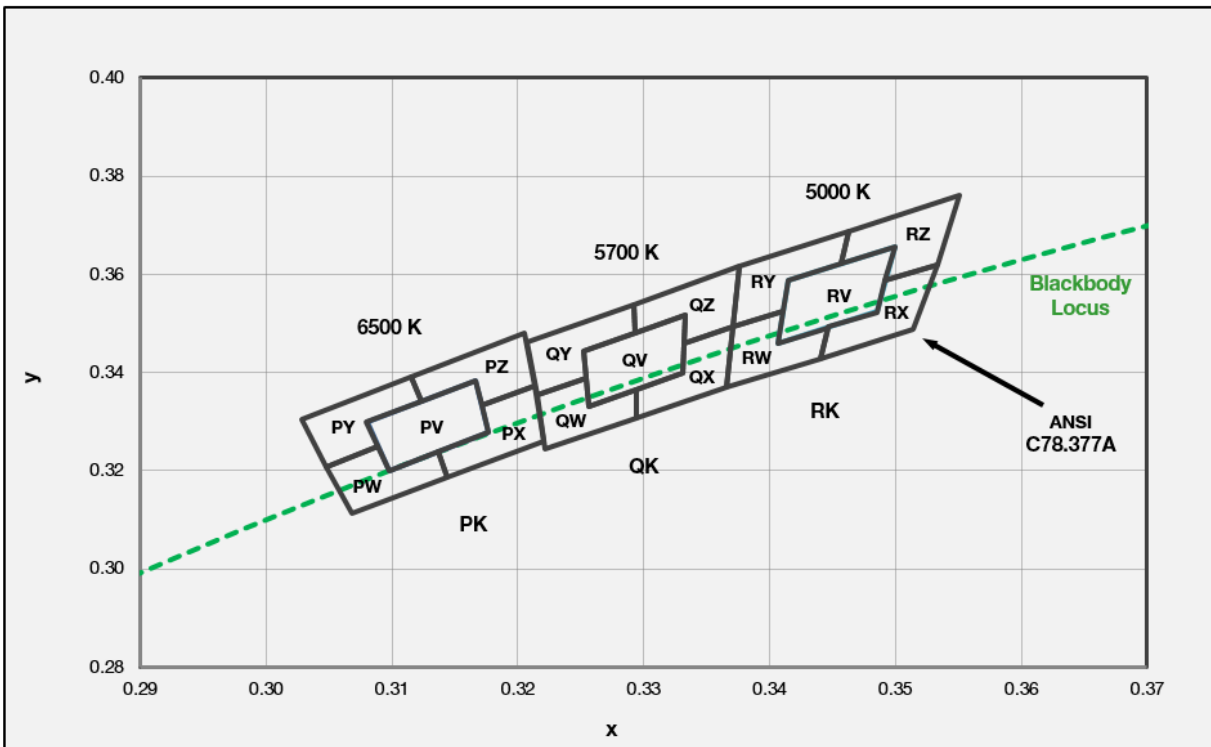
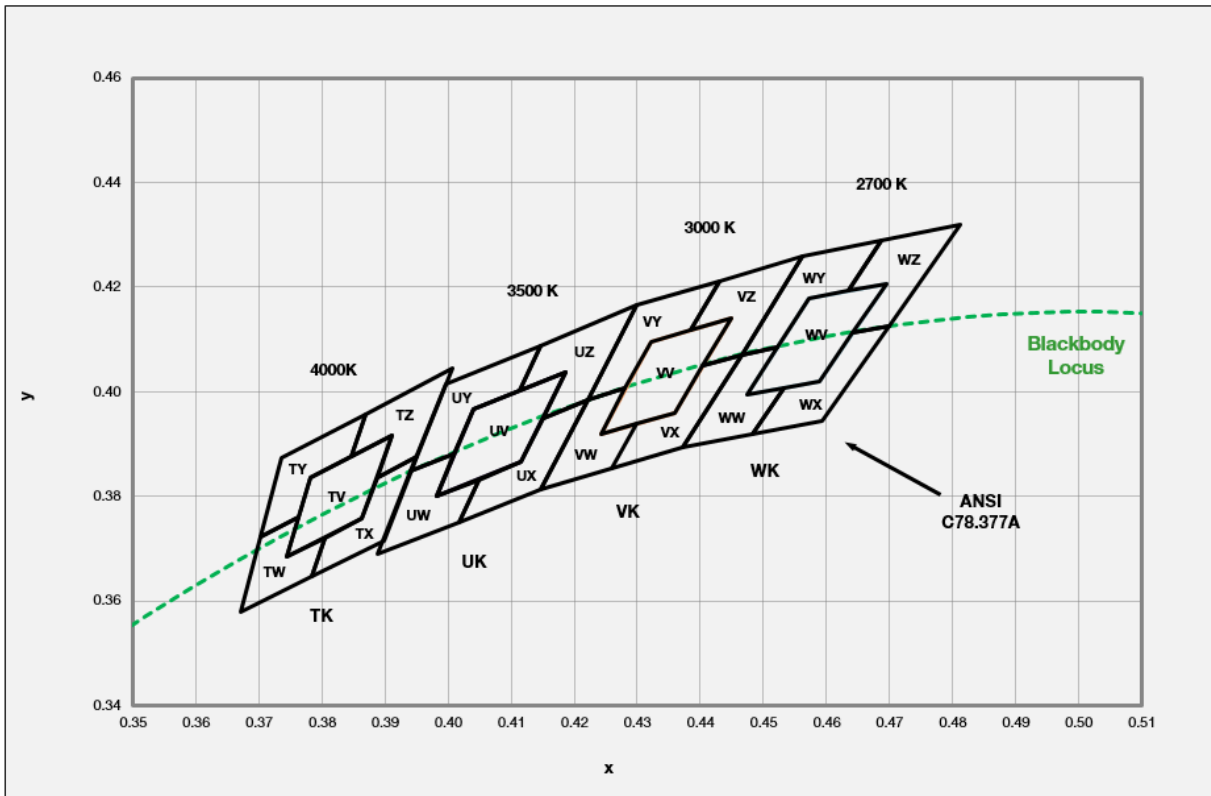

f) Kitting Chromaticity Region & Coordinates

Region	CIE x	CIE y	Region	CIE x	CIE y
<b>W rank (2700 K)</b>					
WV	0.4475	0.3994			
	0.4589	0.4021			
	0.4695	0.4207			
	0.4573	0.4178			
WW	0.4373	0.3893	WY	0.4465	0.4071
	0.4483	0.3919		0.4523	0.4085
	0.4532	0.4008		0.4573	0.4178
	0.4475	0.3994		0.4634	0.4193
	0.4523	0.4085		0.4687	0.4289
	0.4465	0.4071		0.4562	0.4260
WX	0.4483	0.3919	WZ	0.4641	0.4112
	0.4593	0.3944		0.4700	0.4126
	0.4700	0.4126		0.4813	0.4319
	0.4641	0.4112		0.4687	0.4289
	0.4589	0.4021		0.4634	0.4193
	0.4532	0.4008		0.4695	0.4207

Region	CIE x	CIE y	Region	CIE x	CIE y
<b>V rank (3000 K)</b>					
VW	0.4242	0.3919			
	0.4359	0.3960			
	0.4449	0.4141			
	0.4322	0.4096			
VW	0.4147	0.3814	VY	0.4221	0.3984
	0.4259	0.3853		0.4281	0.4006
	0.4300	0.3939		0.4322	0.4096
	0.4242	0.3919		0.4385	0.4119
	0.4281	0.4006		0.4430	0.4212
	0.4221	0.3984		0.4299	0.4165
VX	0.4259	0.3853	VZ	0.4403	0.4049
	0.4373	0.3893		0.4465	0.4071
	0.4465	0.4071		0.4562	0.4260
	0.4403	0.4049		0.4430	0.4212
	0.4359	0.3960		0.4385	0.4119
	0.4300	0.3939		0.4449	0.4141

Region	CIE x	CIE y	Region	CIE x	CIE y
<b>U rank (3500 K)</b>					
UV	0.3981	0.3800			
	0.4116	0.3865			
	0.4186	0.4037			
	0.4040	0.3966			
UW	0.3889	0.3690	UY	0.3941	0.3848
	0.4017	0.3751		0.4010	0.3882
	0.4048	0.3832		0.4040	0.3966
	0.3981	0.3800		0.4113	0.4001
	0.4010	0.3882		0.4146	0.4089
	0.3941	0.3848		0.3996	0.4015
UX	0.4017	0.3751	UZ	0.4150	0.3950
	0.4147	0.3814		0.4221	0.3984
	0.4221	0.3984		0.4299	0.4165
	0.4150	0.3950		0.4146	0.4089
	0.4116	0.3865		0.4113	0.4001
	0.4048	0.3832		0.4186	0.4037

Region	CIE x	CIE y	Region	CIE x	CIE y
<b>T rank (4000 K)</b>					
TV	0.3744	0.3685			
	0.3863	0.3758			
	0.3912	0.3917			
	0.3782	0.3837			
TW	0.3670	0.3578	TY	0.3702	0.3722
	0.3783	0.3646		0.3763	0.3760
	0.3804	0.3721		0.3782	0.3837
	0.3744	0.3685		0.3847	0.3877
	0.3763	0.3760		0.3869	0.3958
	0.3702	0.3722		0.3736	0.3874
TX	0.3783	0.3646	TZ	0.3887	0.3837
	0.3898	0.3716		0.3950	0.3875
	0.3950	0.3875		0.4006	0.4044
	0.3887	0.3837		0.3869	0.3958
	0.3863	0.3758		0.3847	0.3877
	0.3804	0.3721		0.3912	0.3917





f) Kitting Chromaticity Region & Coordinates

Region	CIE x	CIE y	Region	CIE x	CIE y
<b>R rank (5000 K)</b>					
RV	0.3407	0.3460			
	0.3485	0.3524			
	0.3500	0.3655			
	0.3415	0.3588			
RW	0.3366	0.3369	RY	0.3371	0.3493
	0.3440	0.3427		0.3411	0.3525
	0.3446	0.3491		0.3415	0.3588
	0.3407	0.3460		0.3457	0.3621
	0.3411	0.3525		0.3463	0.3687
	0.3371	0.3493		0.3376	0.3616
RX	0.3440	0.3428	RZ	0.3457	0.3621
	0.3514	0.3487		0.3500	0.3655
	0.3533	0.3620		0.3492	0.3587
	0.3492	0.3587		0.3533	0.3620
	0.3485	0.3522		0.3551	0.3760
	0.3446	0.3493		0.3463	0.3687

Region	CIE x	CIE y	Region	CIE x	CIE y
<b>Q rank (5700 K)</b>					
QV	0.3256	0.3331			
	0.3331	0.3398			
	0.3333	0.3518			
	0.3252	0.3444			
QW	0.3222	0.3243	QY	0.3215	0.3353
	0.3294	0.3306		0.3254	0.3388
	0.3294	0.3364		0.3252	0.3444
	0.3256	0.3331		0.3293	0.3481
	0.3254	0.3388		0.3292	0.3539
	0.3215	0.3353		0.3207	0.3462
QX	0.3294	0.3306	QZ	0.3293	0.3481
	0.3366	0.3369		0.3333	0.3518
	0.3371	0.3493		0.3332	0.3458
	0.3332	0.3458		0.3371	0.3493
	0.3331	0.3398		0.3376	0.3616
	0.3294	0.3364		0.3292	0.3539

Region	CIE x	CIE y	Region	CIE x	CIE y
<b>P rank (6500 K)</b>					
PV	0.3098	0.3199			
	0.3177	0.3278			
	0.3166	0.3384			
	0.3080	0.3298			
PW	0.3068	0.3113	PY	0.3048	0.3207
	0.3144	0.3186		0.3089	0.3249
	0.3137	0.3238		0.308	0.3298
	0.3098	0.3199		0.3123	0.3341
	0.3089	0.3249		0.3115	0.3391
	0.3048	0.3207		0.3028	0.3304
PX	0.3144	0.3186	PZ	0.3123	0.3341
	0.3221	0.3261		0.3166	0.3384
	0.3213	0.3373		0.3172	0.3332
	0.3172	0.3332		0.3213	0.3373
	0.3177	0.3278		0.3205	0.3481
	0.3137	0.3238		0.3115	0.3391

**Note:**

Samsung maintains measurement tolerance of: Cx, Cy = ±0.005



### 3. Typical Characteristics Graphs

#### a) Spectrum Distribution ( $I_f = 150 \text{ mA}$ , $T_s = 25 \text{ }^\circ\text{C}$ )

CCT: 2700 K (80 CRI)

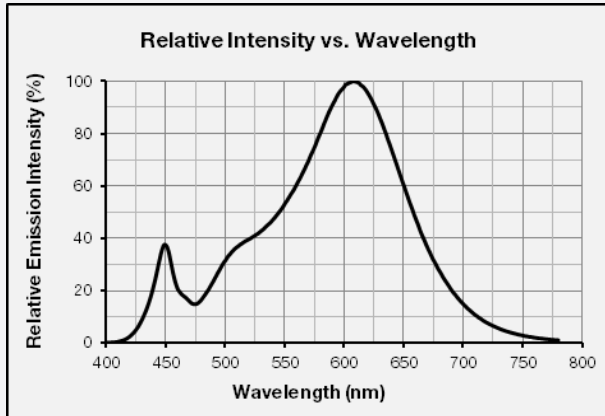

CCT: 3000 K (80 CRI)

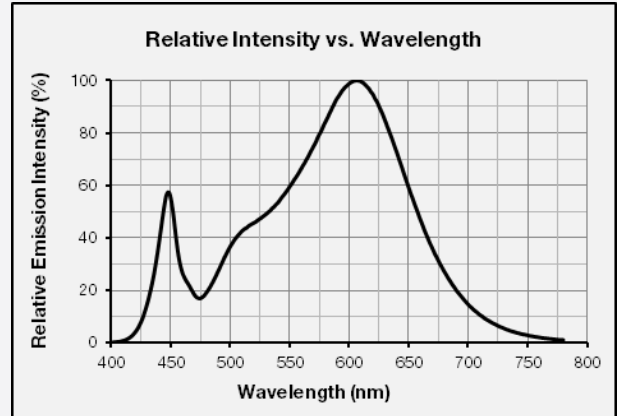

CCT: 3500 K (80 CRI)

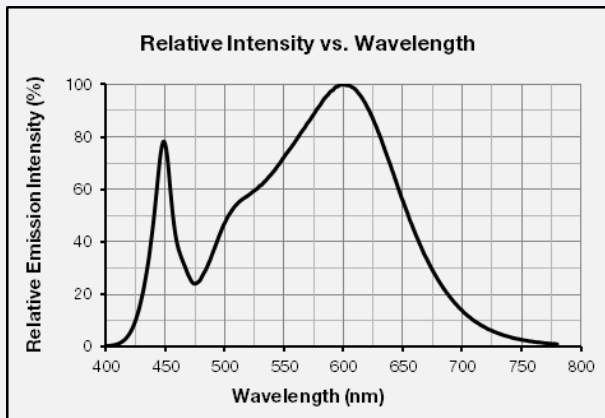

CCT: 4000 K (80 CRI)

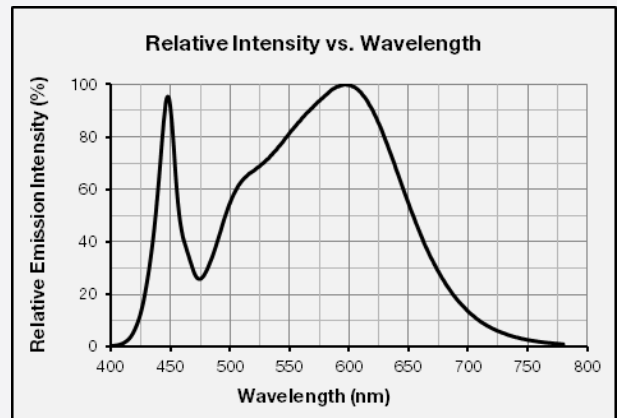

CCT: 5000 K (80 CRI)

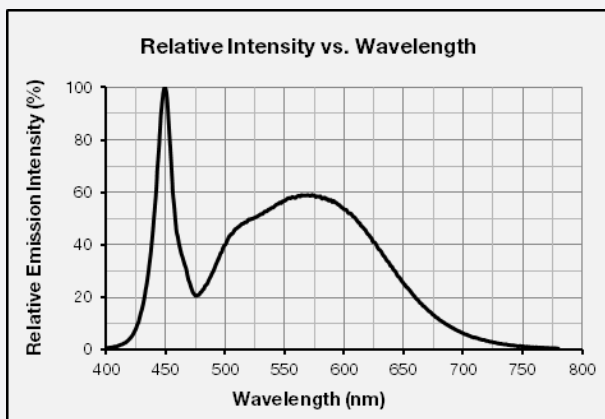

CCT: 5700 K (80 CRI)

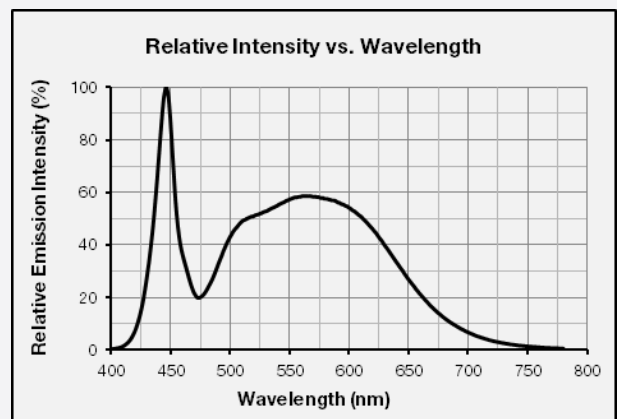

CCT: 6500 K (80 CRI)

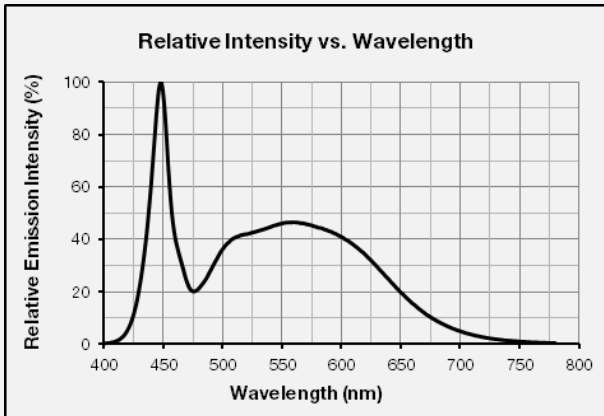

**b) Forward Current Characteristics (Ts = 25 °C)**

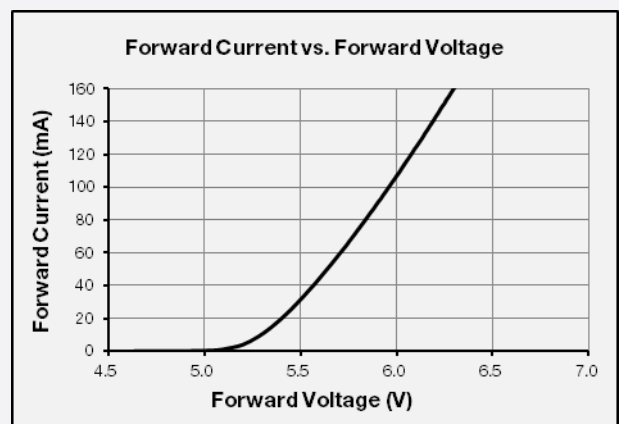
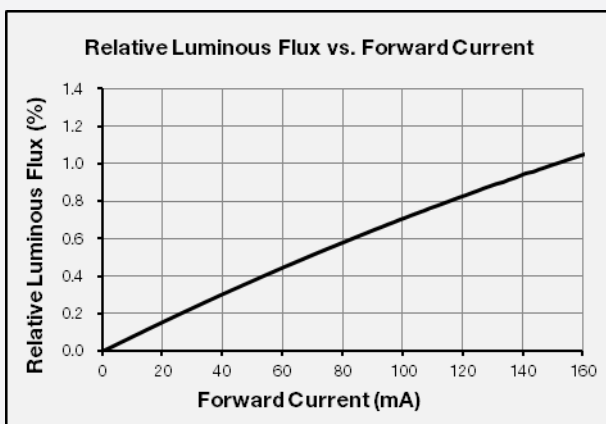

**c) Temperature Characteristics (IF = 150 mA)**

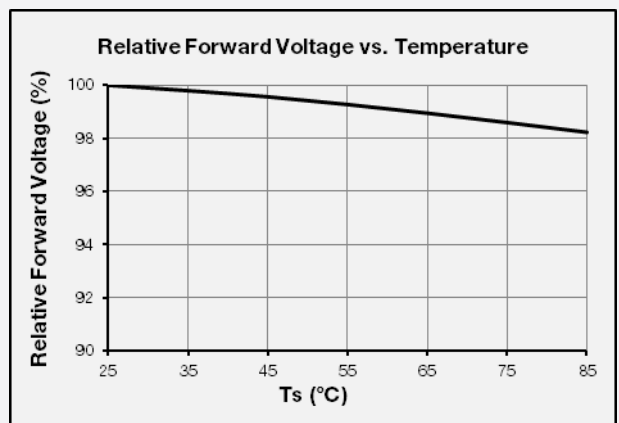
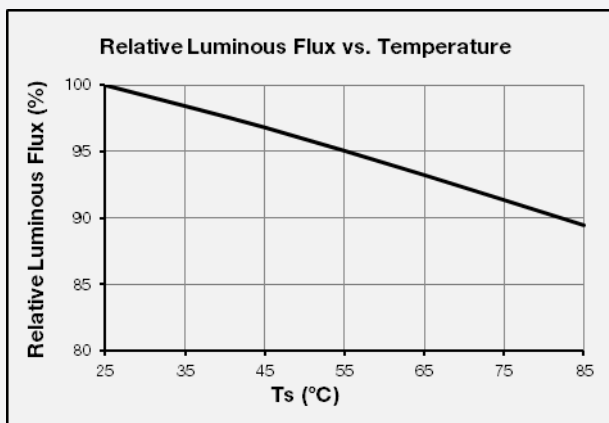

d) Color Shift Characteristics (IF = 150 mA, Ts = 25 °C)

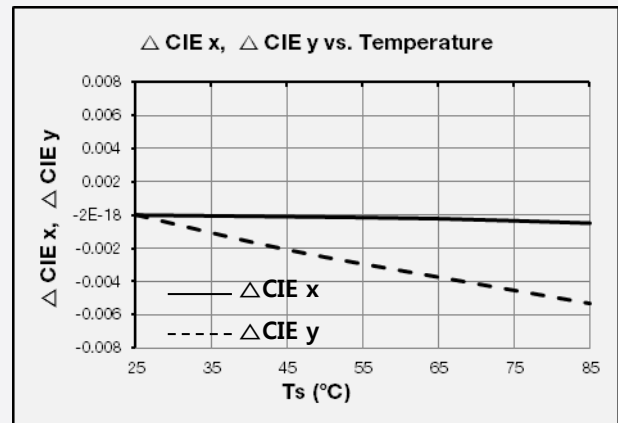
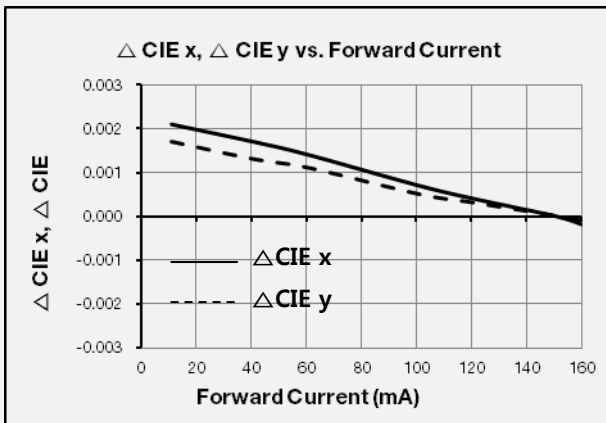

e) Derating Curve

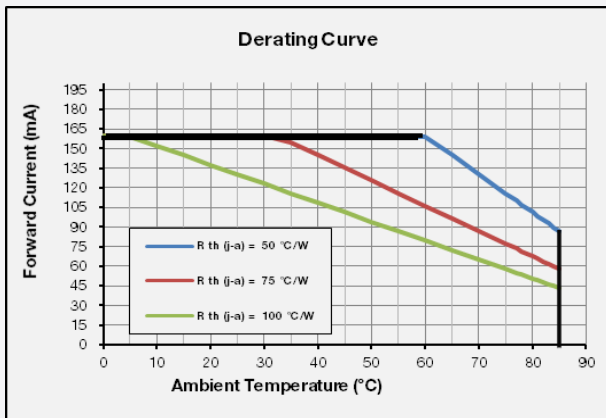

f) Beam Angle Characteristics (IF = 150 mA, Ts = 25 °C)

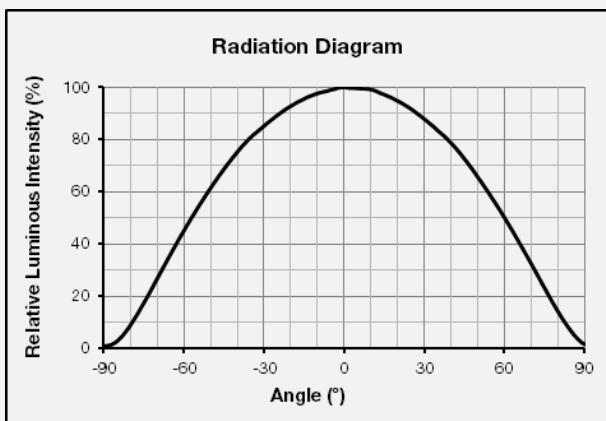

#### 4. Outline Drawing & Dimension

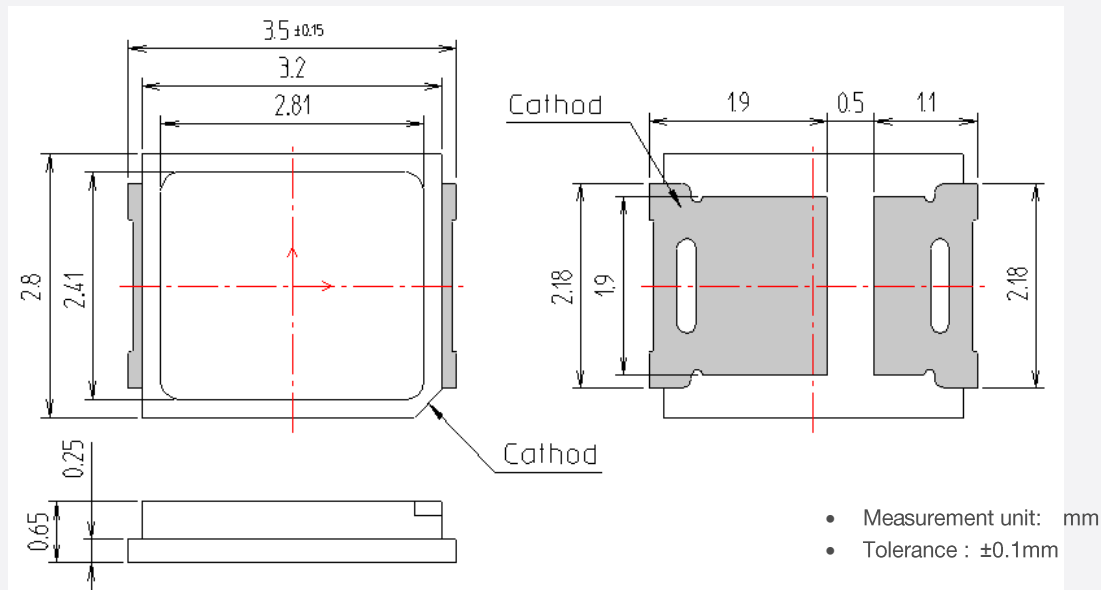

[Recommended PCB Solder PAD]

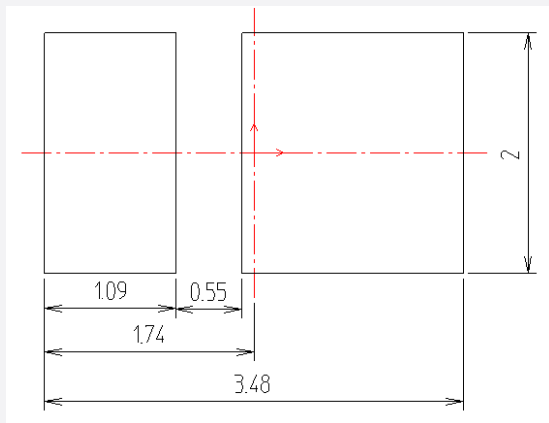

#### Notes:

- 1) This LED has built-in ESD protection device(s) connected in parallel to LED chip(s).
- 2)  $T_s$  point and measurement method:
  - ① Measure one point at the cathode pad, if necessary remove PSR of PCB to reach  $T_s$  point.
  - ② All pads must be soldered to the PCB to dissipate heat properly, otherwise the LED can be damaged.

#### Precautions:

- 1) Pressure on the LEDs will influence to the reliability of the LEDs. Precautions should be taken to avoid strong pressure on the LEDs. Do not put stress on the LEDs during heating.
- 2) Re-soldering should not be done after the LEDs have been soldered. If re-soldering is unavoidable, LED's characteristics should be carefully checked before and after such repair.
- 3) Do not stack assembled PCBs together. Since materials of LEDs is soft, abrasion between two PCB assembled with LED might cause catastrophic failure of the LEDs.



## 5. Reliability Test Items & Conditions

### a) Test Items

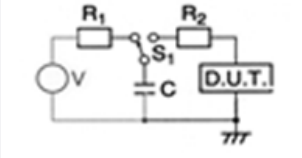
Test Item	Test Condition	Test Hour / Cycle	Sample No.
Room Temperature Life Test	25 °C, DC 160 mA	1000 h	22
High Temperature Life Test	85 °C, DC 160 mA	1000 h	22
High Temperature Humidity Life Test	85 °C, 85 % RH, DC 160 mA	1000 h	22
Low Temperature Life Test	-40 °C, DC 160 mA	1000 h	22
Powered Temperature Cycle Test	-45 °C ~ 85 °C, each 20 min, on/off 5 min Temp. Change time 100min, DC 160 mA	100 cycles	22
Temperature Cycling	-45 °C / 15 min ↔ 125 °C / 15 min	200 cycles	100
High Temperature Storage	120 °C	1000 h	11
Low Temperature Storage	-40 °C	1000 h	11
ESD (HBM)	 <p>           R<sub>1</sub>: 10 MΩ            R<sub>2</sub>: 1.5 kΩ            C: 100 pF            V: ±2 kV         </p>	5 times	30

### b) Criteria for Judging the Damage

Item	Symbol	Test Condition (T <sub>s</sub> = 25 °C)	Limit	
			Min	Max
Forward Voltage	V <sub>F</sub>	I <sub>F</sub> = 160 mA	Init. Value * 0.9	Init. Value * 1.1
Luminous Flux	Φ <sub>v</sub>	I <sub>F</sub> = 160 mA	Init. Value * 0.7	Init. Value * 1.1

## 6. Soldering Conditions

### a) Reflow Conditions (Pb free)

Reflow frequency: 2 times max.

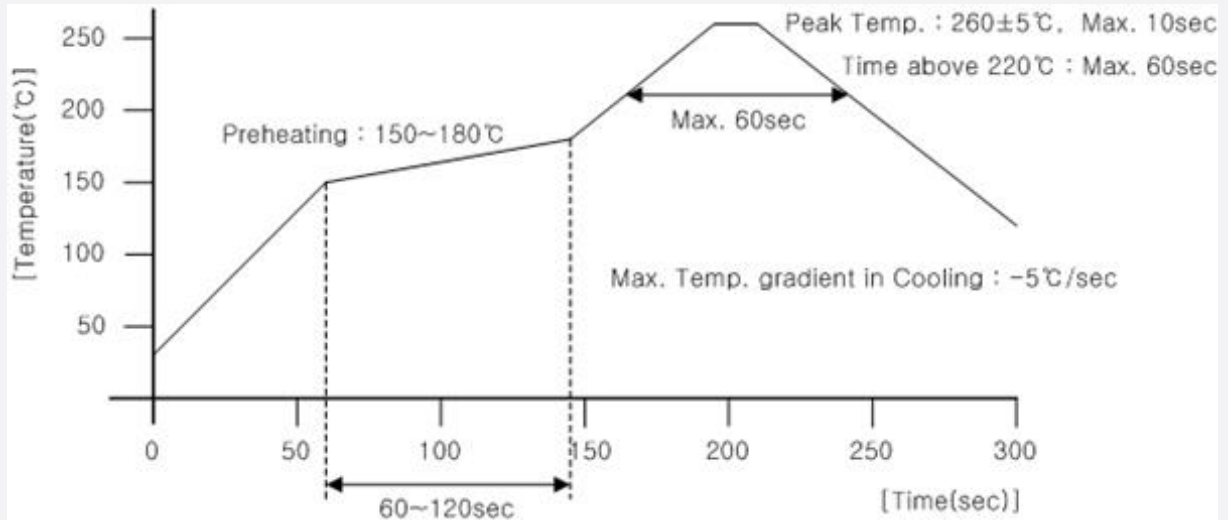

### b) Manual Soldering Conditions

Not more than 5 seconds @ max. 300 °C, under soldering iron.

## 7. Tape & Reel

### a) Taping Dimension

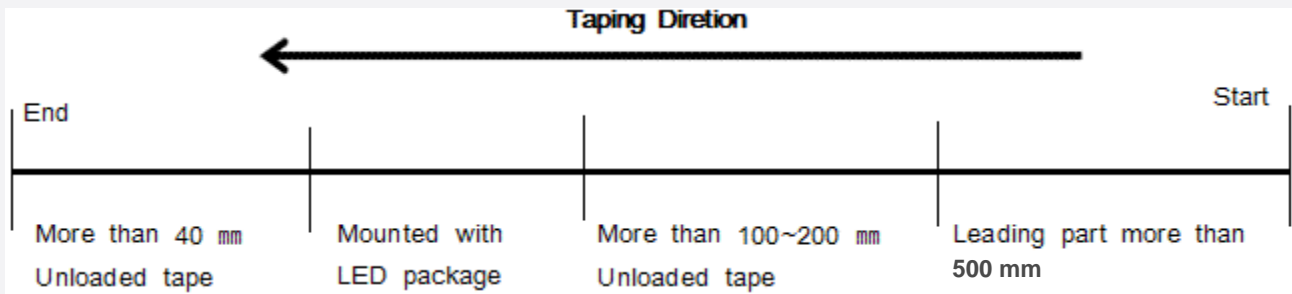
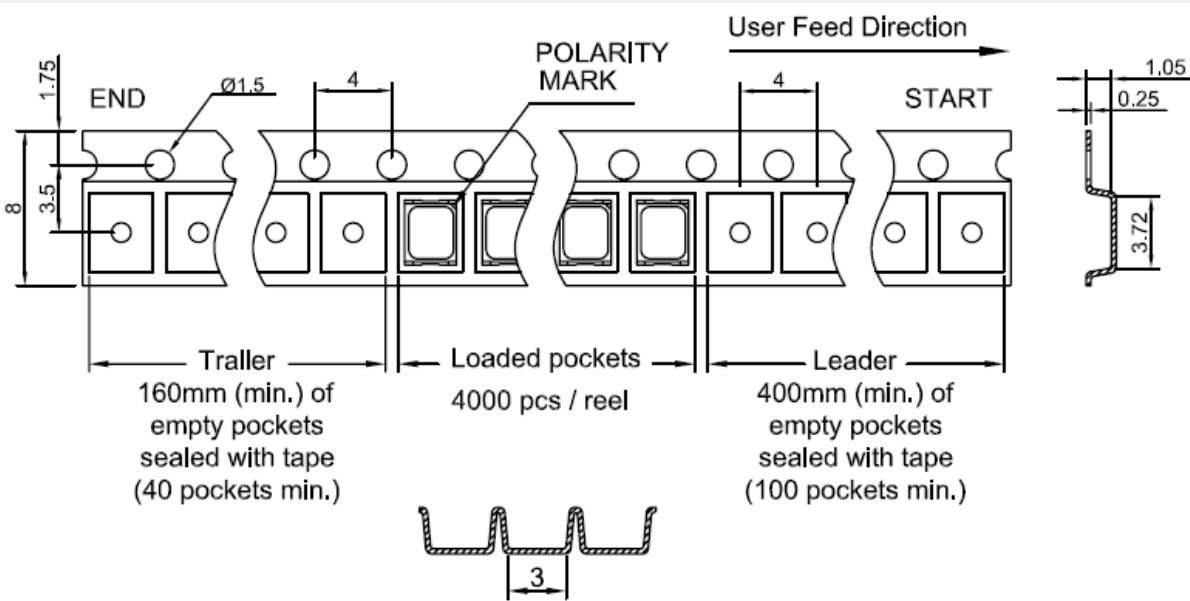



## b) Reel Dimension

(unit: mm)

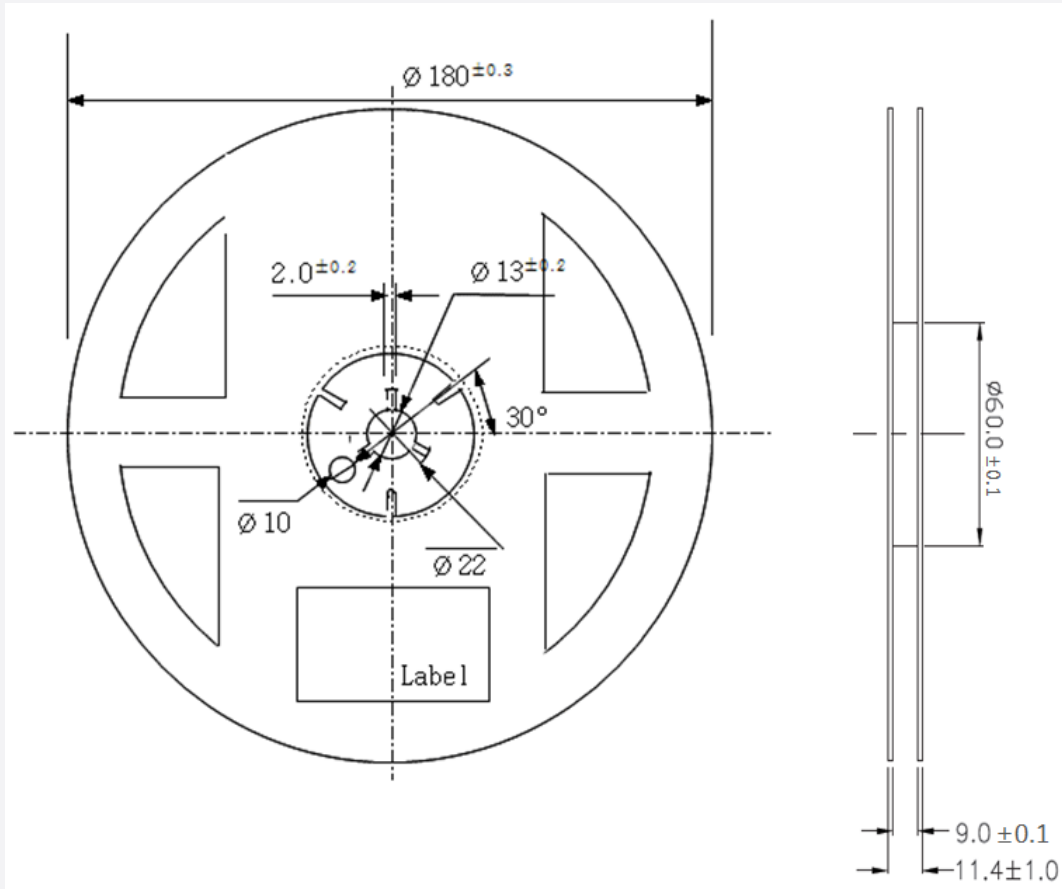
**Notes:**

- 1) Quantity: The quantity/reel is 4,000 pcs
- 2) All dimensions are millimeters (tolerance :  $\pm 0.2\text{mm}$ )
- 3) Packaging: P/N, Manufacturing data code no. and quantity are indicated on the aluminum packing bag

## 8. Label Structure

### a) Label Structure

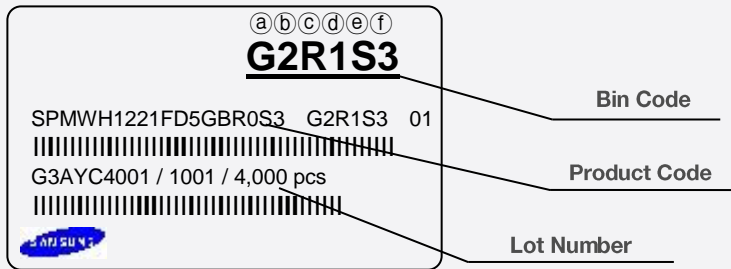

Note: Denoted bin code and product code above is only an example (see description on page 5)

Bin Code:

- ⒶⒷ: Forward Voltage bin (refer to page 9)
- ⒸⒹ: Chromaticity bin (refer to page 10-17)
- ⒺⒻ: Luminous Flux bin (refer to page 6)

### b) Lot Number

The lot number is composed of the following characters:



①②③④⑤⑥⑦⑧⑨ / 1ⒶⒷⒸ / 4,000 pcs

- ① : Production site (S: Giheung, Korea, G: Tianjin, China)
- ② : 3 (LED)
- ③ : Product state (A: Normal, B: Bulk, C: First Production, R: Reproduction, S: Sample)
- ④ : Year (Z: 2015, A: 2016, B: 2017...)
- ⑤ : Month (1~9, A, B, C)
- ⑥⑦⑧⑨ : Day (1~9, A, B~V)
- ⒶⒷⒸ : Product serial number (001 ~ 999)



## 9. Packing Structure

### a) Packing Process

#### Reel

**G2R1S3**  
 SPMWH1221FD5GBR0S3 G2R1S3 01  
 G3AYC4001 / 1001 / 4,000 pcs  

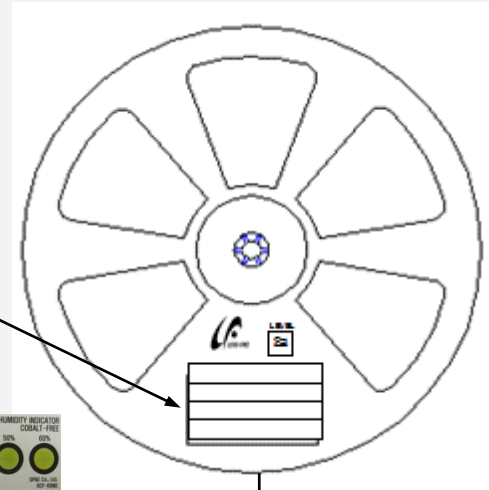

#### Aluminum Vinyl Packing Bag

**G2R1S3**  
 SPMWH1221FD5GBR0S3 G2R1S3 01  
 G3AYC4001 / 1001 / 4,000 pcs  





#### Outer Box

Material: Paper (SW3B(B))

Type	Size (mm)			Note
	L	W	H	
7 inch L	245 ± 5	220 ± 5	182 ± 5	Up to 10 reels
7 inch S	245 ± 5	220 ± 5	86 ± 5	Up to 5 reels

#### ① Side Label

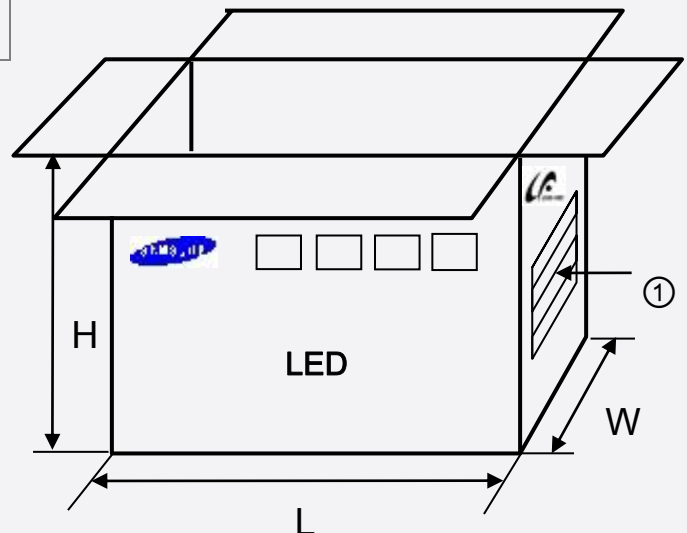
**G2R1S3**  
 SPMWH1221FD5GBR0S3 G2R1S3 01  
 G3AYC4001 / 1001 / 40,000 pcs  



b) Packing Process for kitting

Reel

Kitting 'A'

**G2★WS3**

SPMWH1221FD5GB★KS0 G2★WS3 01

|||||

G3AW94001 / 1001 / 4,000 pcs

|||||



Kitting 'B'

**G2★ZS3**

SPMWH1221FD5GB★KS0 G2★ZS3 01

|||||

G3AW94001 / 1001 / 4,000 pcs

|||||

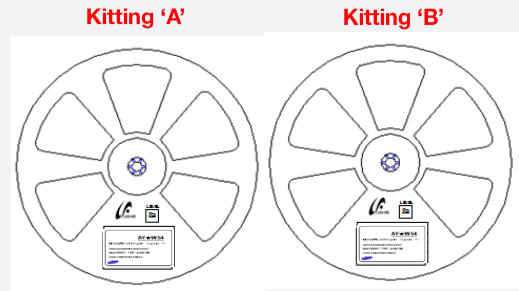
Aluminum Vinyl Packing Bag

Kitting 'A'

**G2★WS3**

SPMWH1221FD5GB★KS0 G2★WS3 01

|||||

G3AW94001 / 1001 / 4,000 pcs

|||||



Kitting 'B'

**G2★ZS3**

SPMWH1221FD5GB★KS0 G2★ZS3 01

|||||

G3AW94001 / 1001 / 4,000 pcs

|||||

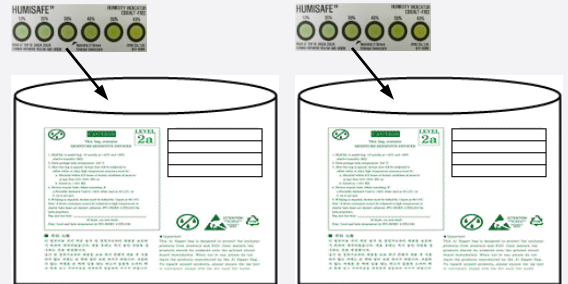
Outer Box

Kitting 'A'

**G2★WS4**

SPMWH1221FD5GB★KS0 G2★WS3 01

|||||

G3AW94001 / 1001 / 20,000 pcs

|||||

[BOX Label]



Kitting 'B'

**G2★ZS4**

SPMWH1221FD5GB★KS0 G2★ZS3 01

|||||

G3AW94001 / 1001 / 20,000 pcs

|||||

[BOX Label]

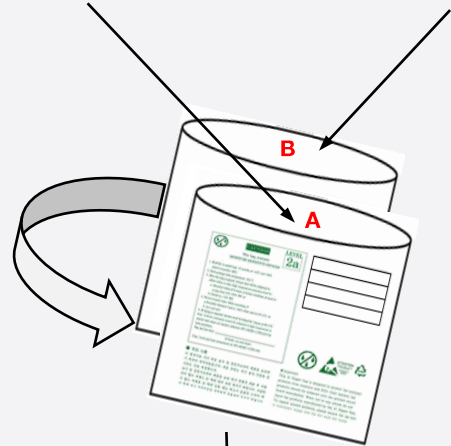

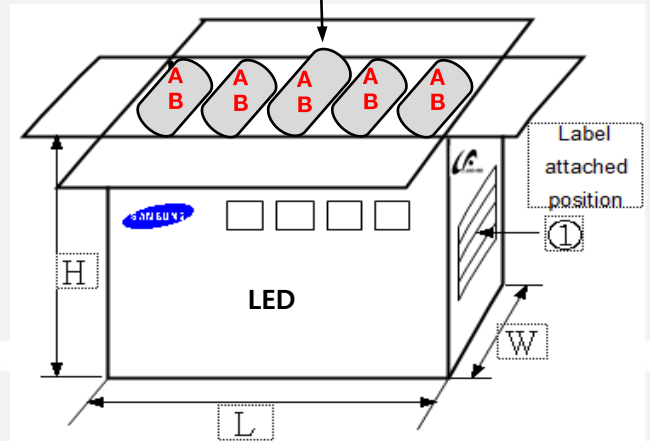

Material: Paper (SW3B(B))

Type	Size (mm)			Note
	L	W	H	
7 inch L	245 ± 5	220 ± 5	182 ± 5	Up to 10 reels



### b) Aluminum Vinyl Packing Bag



**CAUTION**

This bag contains  
**MOISTURE SENSITIVE DEVICES**

**LEVEL**  
**2a**

**G2R1S3**

SPMWH1221FD5GBR0S3 G2R1S3 01  
 G3AYC4001 / 1001 / 4,000 pcs

1. Shelf life in sealed bag: 12 months at <40℃ and <90% relative humidity (RH)
2. Peak package body temperature: 240 ℃
3. After this bag is opened, devices that will be subjected to reflow solder or other high temperature processes must be:
  - a. Mounted within 672 hours at factory conditions of equal to or less than 30℃ /60% RH, or
  - b. Stored at <10% RH
4. Devices require bake, before mounting, if:
  - a. Humidity Indicator Card is >/60% when read at 23±5℃, or
  - b. 2a is not met.
5. If baking is required, devices must be baked for 10 ~ 24 hours at 60±5℃

Note: If device containers cannot be subjected to high temperature or shorter bake times are desired, reference IPC/JEDEC J-STD-033 for bake procedure.

Bag seal due date: \_\_\_\_\_  
(If blank, see code label)

Note: Level and body temperature by IPC/JEDEC J-STD-020









**주의 사항**

이 알루미늄 지퍼 백은 습기 및 정전기로부터 제품을 보호하기 위하여 제작되었습니다. 개봉 후에는 즉시 솔더 작업을 실시하는 것을 권장합니다.

습기 및 정전기로부터 제품을 보호 하기 위해서 개봉 후 사용하지 않는 자재는 본 팩에 넣어 보관 하시기 바랍니다. 사용하지 않는 자재를 본 팩에 넣을 때는 반드시 동봉된 드라이 팩과 함께 넣고 지퍼부분을 완전하게 밀봉하여 주시기 바랍니다.

**Important**

This Al Zipper bag is designed to protect the enclosed products from moisture and ESD. Once opened, the products should be soldered onto the printed circuit board immediately. When not in use, please do not leave the products unprotected by the Al Zipper Bag. To repack unused products., please ensure the zip-lock is completely sealed with the dry pack left inside.

### c) Humidity Indicator Card inside Aluminum Vinyl Bag

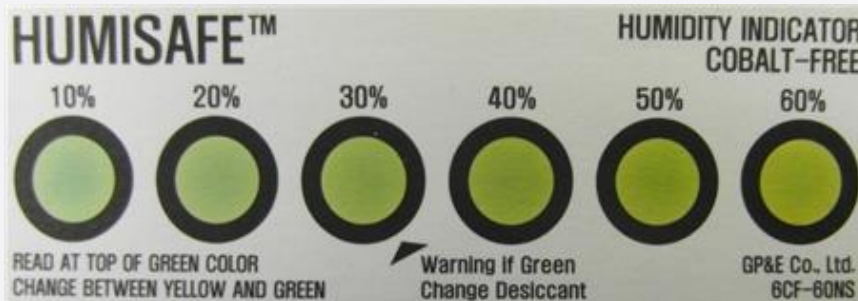

## 10. Precautions in Handling & Use

- 1) For over-current protection, users are recommended to apply resistors connected in series with the LEDs to mitigate sudden change of the forward current caused by shift of forward voltage.
- 2) This device should not be used in any type of fluid such as water, oil, organic solvent, etc. When cleaning is required, IPA is recommended as the cleaning agent. Some solvent-based cleaning agent may damage the silicone resins used in the device.
- 3) When the device is in operation, the forward current should be carefully determined considering the maximum ambient temperature and corresponding junction temperature.
- 4) LEDs must be stored in a clean environment. If the LEDs are to be stored for three months or more after being shipped from Samsung, they should be packed with a nitrogen-filled container (shelf life of sealed bags is 12 months at temperature 0~40 °C, 0~90 % RH).
- 5) After storage bag is opened, device subjected to soldering, solder reflow, or other high temperature processes must be:
  - a. Mounted within 672 hours (28 days) at an assembly line with a condition of no more than 30 °C / 60 % RH, or
  - b. Stored at <10 % RH
- 6) Repack unused devices with anti-moisture packing, fold to close any opening and then store in a dry place.
- 7) Devices require baking before mounting, if humidity card reading is >60 % at 23 ± 5 °C.
- 8) Devices must be baked for 1 hour at 60 ± 5 °C, if baking is required.
- 9) The LEDs are sensitive to the static electricity and surge current. It is recommended to use a wrist band or anti-electrostatic glove when handling the LEDs. If voltage exceeding the absolute maximum rating is applied to LEDs, it may cause damage or even destruction to LED devices. Damaged LEDs may show some unusual characteristics such as increase in leakage current, lowered turn-on voltage, or abnormal lighting of LEDs at low current.
- 10) VOCs (Volatile Organic Compounds) can be generated from adhesives, flux, hardener or organic additives used in luminaires (fixtures). Transparent LED silicone encapsulant is permeable to those chemicals and they may lead to a discoloration of encapsulant when they exposed to heat or light. This phenomenon can cause a significant loss of light emitted (output) from the luminaires. In order to prevent these problems, we recommend users to know the physical properties of materials used in luminaires and they must be carefully selected.
- 11) Risk of sulfurization (or tarnishing)  
 The LED from Samsung uses a silver-plated lead frame and its surface color may change to black (or dark colored) when it is exposed to sulfur (S), chlorine (Cl) or other halogen compound. Sulfurization of lead frame may cause intensity degradation, change of chromaticity coordinates and, in extreme cases, open circuit. It requires caution. Due to possible sulfurization of lead frame, LED should not be used and stored together with oxidizing substances made of materials such as rubber, plain paper, lead solder cream, etc.



# Legal and additional information.

## [About Samsung Electronics Co., Ltd.](#)

Samsung Electronics Co., Ltd. is a global leader in technology, opening new possibilities for people everywhere. Through relentless innovation and discovery, we are transforming the worlds of TVs, smartphones, tablets, PCs, cameras, home appliances, printers, LTE systems, medical devices, semiconductors and LED solutions. We employ 286,000 people across 80 countries with annual sales of US\$216.7 billion. To discover more, please visit [www.samsungled.com](http://www.samsungled.com).

Copyright © 2015 Samsung Electronics Co., Ltd. All rights reserved.  
Samsung is a registered trademark of Samsung Electronics Co., Ltd.  
Specifications and designs are subject to change without notice. Non-metric weights and measurements are approximate. All data were deemed correct at time of creation. Samsung is not liable for errors or omissions. All brand, product, service names and logos are trademarks and/or registered trademarks of their respective owners and are hereby recognized and acknowledged.

Samsung Electronics Co., Ltd.  
95, Samsung 2-ro  
Giheung-gu  
Yongin-si, Gyeonggi-do, 446-711  
KOREA

[www.samsungled.com](http://www.samsungled.com)



单击下面可查看定价，库存，交付和生命周期等信息

[>>Samsung Semiconductor\(三星半导体\)](#)